



PRO-LOG
CORPORATION

VOLUME I
Control Unit

User's Manual

M980 CONTROL UNIT



The information in this manual has been carefully reviewed and is believed to be entirely reliable. However, no responsibility is assumed for inaccuracies. Furthermore, such information does not convey to the purchaser of the equipment described any license under the patent right of Pro-Log Corporation or others.

The material in this manual is subject to change, and Pro-Log Corporation reserves the right to change specifications without notice.

WARRANTY: Seller warrants that the articles furnished hereunder are free from defects in material and workmanship and perform to applicable, published PRO-LOG specifications for one year from date of shipment (two years for M980 Control Units). This warranty is in lieu of any other warranty expressed or implied. In no event will Seller be liable for special or consequential damages as a result of any alleged breach of this warranty provision. The liability of Seller hereunder shall be limited to replacing or repairing, at its option, any defective units which are returned. Equipment or parts which have been subject to abuse, misuse, accident, alteration, neglect, unauthorized repair or installation are not covered by warranty. Seller shall have the right of final determination as to the existence and cause of defect. As to items repaired or replaced, the warranty shall continue in effect for the remainder of the warranty period, or for ninety (90) days following date of shipment by Seller of the repaired or replaced part whichever period is longer. No liability is assumed for expendable items such as lamps and fuses. No warranty is made with respect to custom equipment or products produced, to Buyer's specifications except as specifically stated in writing by Seller and contained in the contract.

Copyright © 1980 by Pro-Log Corporation, Monterey, CA 93940. All rights reserved. Printed in the U.S.A. No part of this publication may be reproduced, stored in a retrieval system, or transmitted, in any form or by any means, electronic, mechanical, photocopying, or otherwise, without the prior written permission of the publisher.

WHAT IS AN M980 PROM PROGRAMMER?

The M980 is analogous to a typewriter or copier and a PROM is, likewise, analogous to an electronic piece of paper. By inserting the appropriate typing element (Personality Module), the user can type (program), read, copy (duplicate), or proof (compare) an electronic piece of paper (PROM). The M980 even allows copying with corrections. One word of caution: these electronic pieces of paper (PROMs) have a top line (First Address), bottom line (Last Address), and pin positions already assigned.

Further articles on PROM and microprocessor technology are found in Pro-Log's *PROM User's Guide* and *Microprocessor User's Guide*.

If you would like to know:

See Page

1. How do I install a Personality Module, and what part of the PROM is the top and what part is the bottom?	3-2
2. How do I tell how many addresses (lines) are in my device and how can I start in the middle if I want to?	4-1
3. Is my PROM blank (empty)?	5-17
4. How do I program a PROM?	5-2
5. How can I read a PROM?	5-6
6. How can I make a copy of my original PROM?	5-8
7. How can I verify that the copy is the same as the original PROM?	5-11
8. Has my PROM lost any of its original data? How can I check this?	5-13
9. If I make a mistake, how can I correct it?	10-1
10. What do I do if my PROM won't program?	11-1
11. How can I test the Programmer?	14-1

For more detailed information on the many functions you can perform on your M980 Programmer, see the table of contents beginning on the next page.

M980 CONTROL UNIT USER'S MANUAL**Table of Contents**

Section 1 M980 Summary	1-1
Description	1-1
Operating Features.....	1-1
Optional Equipment and Capability	1-1
Hexadecimal Notation	1-2
 Section 2 Operating Panel Description	 2-1
Displays and Indicators	2-1
Keyboard	2-2
Toggle Switches	2-2
Control Keys	2-2
 Section 3 Personality Module Descriptions	 3-1
Description	3-1
Dedicated Modules.....	3-1
Generic Modules.....	3-3
Gang Modules	3-4
Special Personality Module Instructions.....	3-5
PROM Handling	3-5
ZIF Sockets.....	3-5
 Section 4 Address Field Definition	 4-1
Full Address Operation.....	4-1
Partial Address Operation	4-1
 Section 5 COPY and MASTER Socket Operations	 5-1
Operation Summary.....	5-1
Reset.....	5-1
Toggle Switch Selection.....	5-2
Programming a PROM	5-3
Reading a Copy PROM in the COPY Socket	5-5
Reading a Master PROM in the MASTER Socket.....	5-7
Duplicating a PROM from a Master PROM	5-9
Comparing a Copy PROM with a Master PROM	5-13
Performing a Checksum on a Master PROM	5-15
Performing a Checksum on a Copy PROM	5-17
Performing a Blank Check on a Master PROM.....	5-19
Performing a Blank Check on a Copy PROM	5-21
Performing an Illegal Bit Check on a Copy PROM from the Master PROM	5-23

Section 6 Buffer Operations To/From a Copy or Master PROM	6-1
Summary	6-1
Duplicating the RAM Buffer from a Master PROM.....	6-3
Comparing the RAM Buffer with a Master PROM	6-5
Duplicating the RAM Buffer into a Copy PROM.....	6-7
Comparing the RAM Buffer to a Copy PROM.....	6-11
Performing an Illegal Bit Check on a Copy PROM from the Buffer	6-15
Section 7 Additional Buffer Operations	7-1
Programming the RAM Buffer using the M980 Keyboard	7-2
Reading the RAM Buffer using the M980 Keyboard	7-5
Performing a Read/Modify on the RAM Buffer	7-7
Performing a Checksum on the M980 RAM Buffer	7-9
Buffer Edit Modes	
Buffer Edit—Set Word Size	7-11
Buffer Edit—Invert (Complement)	7-13
Buffer Edit—Fill Buffer	7-15
Buffer Edit—Insert	7-17
Buffer Edit—Delete.....	7-21
Buffer Edit—Block Move	7-25
Buffer Edit—Nibble Swap.....	7-29
Buffer Edit—Hex Pack.....	7-31
Buffer Edit—Hex Unpack	7-33
Section 8 Manufacturing Mode	8-1
Manufacturing Mode — Automatic Sequencing Operation	8-1
Manufacturing Mode — Single Operation.....	8-3
Section 9 Engineering Auto Sequencing Mode	9-1
Buffer To Copy Operation	9-1
Master To Copy Operation	9-5
Section 10 Clear Key Operations	10-1
General Description	10-1
Example of CLEAR Key Operation	10-1
Section 11 Failure to Program Operations	11-1
Fusible Devices	11-1
UV Erasable Devices	11-1
Example of Error during Duplication	11-1

Section 12 Error and Operation Codes	12-1
Error Indications	12-1
Operation Codes.....	12-2
Section 13 Error and Operation Codes	13-1
Error Indications	13-1
Operation Codes.....	13-2
Section 14 Self-Test Operations	14-1
Keyboard Self-Test Selection	14-1
Toggle Switch Test	14-1
Keyboard (Keyswitch) Test	14-2
Display Test	14-2
RAM Buffer Test	14-2

M980 SUMMARY**Description and Operating Features**

The M980 PROM Programmer is portable, with plug-in Personality Modules. These modules allow the instrument to program a wide range of MOS and bipolar PROMs. The M980 is microprocessor-controlled and interacts with the user for guidance through each operation. The microprocessor also interfaces with the PROM, assuring rapid and accurate PROM programming. The M980 is equipped with a Buffer Memory that allows data manipulation prior to PROM programming. Various input/output interfaces configure the M980 PROM Programmer to operate with a variety of data sources.

M980 MODES		
MANUAL	AUTOMATIC	M980 MANUFACTURING MODES
Read Program Read/Modify (Buffer only)	Compare Duplicate Auto Blank Check (Copy and Master only) Illegal Bit Check Checksum Buffer Edit Options Self-Test	Auto Blank Check Duplicate Compare

All modes have repeat capabilities

Figure 1-1 — M980 Control Unit Operating Features

Optional Equipment

The M980 software for these options is factory-installed. The user simply purchases the appropriate auxiliary adapters to use remote data sources. Optional equipment includes:

9103A UV Erase Light System: Ultra-violet light source with timer for erasing MOS PROMs.

M301 Paper Tape Reader: Combines with 9811 software in M980 to allow Duplicate and Compare operations from Paper Tape. Multiple formats.

M304 RS-232-C Adapter: Combines with 9818 software in M980 to allow Program and List operations via the RS-232-C interface. Multiple formats.

RC12 TTY Cable: Combines with 9812 software to allow Read, Program, Duplicate, and Compare operations from ASR33 type machines.

RC18 Cable: 25 wire cable with lead male and lead female connectors. Used with 9814 or 9818 interfaces.

Series 90 Personality Modules include:

- Individual Zero Insertion Force PROM sockets for Master and Copy PROMs.
- Control switches as required to enable special functions.

Hexadecimal Notation

The M980 uses hexadecimal notation to represent the PROM binary address and data. Hexadecimal notation is a convenient operator language which reduces data handling by representing 16 combinations of four bits with a single character for each combination. The character set for displaying hexadecimal consists of the characters 0 through 9 to represent the binary combinations 0 through 9 and the characters A, B, C, D, E, and F to represent the number combinations 10 through 15.

HEXADECIMAL CHARACTERS	BINARY BITS 8 4 2 1	DECIMAL CHARACTERS
0	0 0 0 0	0
1	0 0 0 1	1
2	0 0 1 0	2
3	0 0 1 1	3
4	0 1 0 0	4
5	0 1 0 1	5
6	0 1 1 0	6
7	0 1 1 1	7
8	1 0 0 0	8
9	1 0 0 1	9
A	1 0 1 0	10
B	1 0 1 1	11
C	1 1 0 0	12
D	1 1 0 1	13
E	1 1 1 0	14
F	1 1 1 1	15

Figure 1-2 — Conversion Table

As an extension of this technique, all 256 combinations of 8 bits can be represented by two hexadecimal characters, as shown in the following examples.

HEXADECIMAL CHARACTERS	BINARY BITS	DECIMAL CHARACTERS
00	0000 0000	0
01	0000 0001	1
3E	0011 1110	62
42	0100 0010	66
E1	1110 0001	225
FF	1111 1111	255

Figure 1-3 — Conversion Table

Going further, all 4096 combinations of 12 bits can be represented by three hexadecimal characters. This technique can be extended indefinitely by adding one hexadecimal character for each four bits of information.

OPERATING PANEL DESCRIPTION

The operating panel shown in Figure 2-1 has all the controls and indicators needed for keyboard operation plus the connectors for operating with remote control options. All data addressing information is represented in hexadecimal notation. A convenient HEX to BINARY conversion table is printed on the control panel to assist the operator. A Dedicated Personality Module is shown plugged into the control unit.

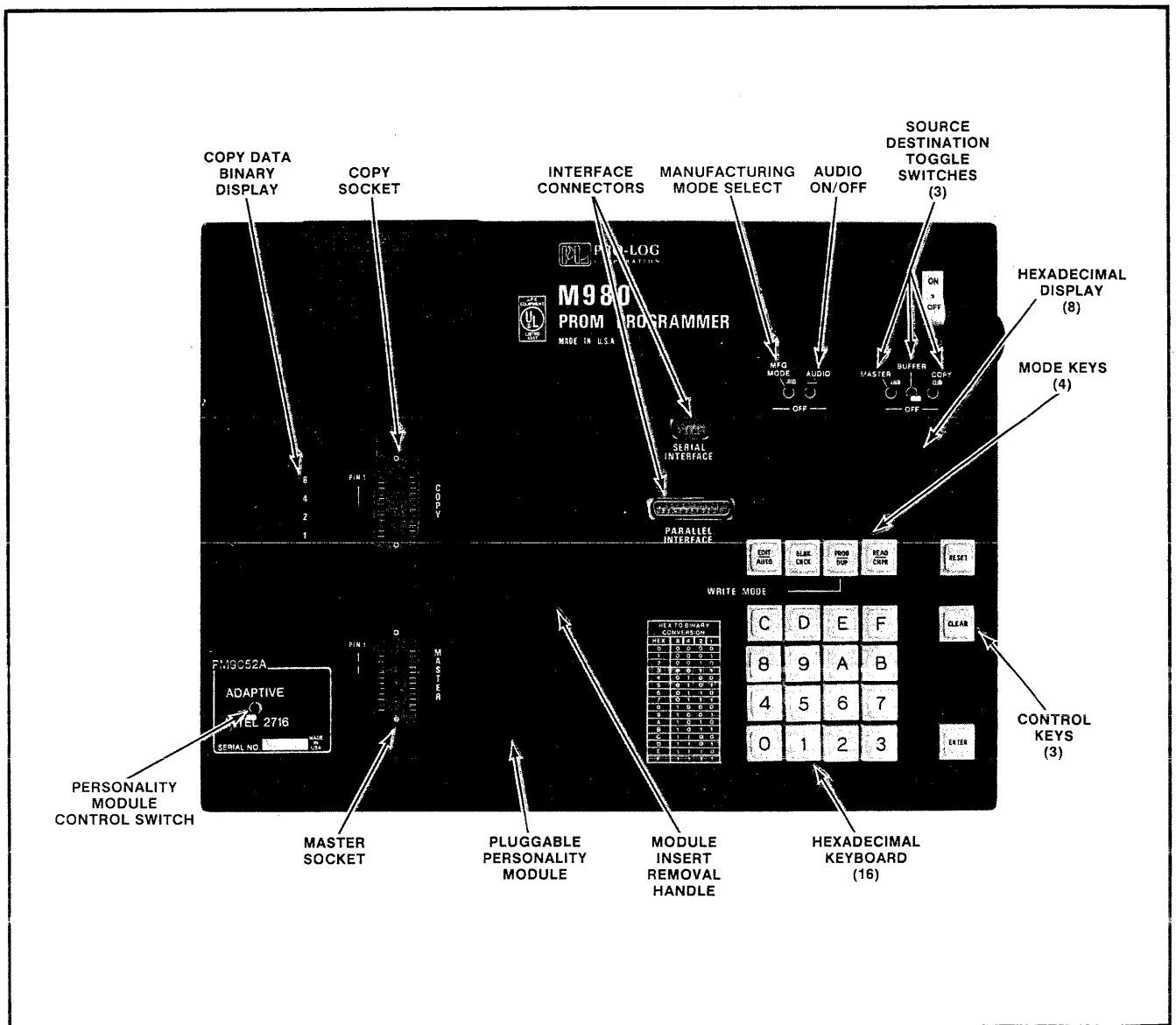

Figure 2-1 — M980 Operating Panel

Displays and Indicators

Write Mode LED: An individual indicator located above the keyboard which lights during a write operation.

Hexadecimal Display: An 8-digit character display capable of showing the hex characters 0-9, A, B, C, D, E, F. This display is located above the keyboard and is used to indicate address, error, option selection, operation and data information.

Binary Data Display: Located on some Personality Modules. It displays data depending on the mode.

Toggle Switches (down = off; up = on)

MANUFACTURING Mode: Locks out hex keyboard and CLEAR key entries. Allows only Automatic (AUTO), Blank Check (BLNK CHCK), Duplicate (DUP), and Compare (CMPR) operations.

AUDIO: Activates a tone generator located inside the M980 unit. This tone generator will then produce audio tones when an error occurs or an operation is finished.

MASTER/BUFFER/COPY: A single switch ON will indicate the Destination on which the operation is being performed. Two switches ON will indicate the Source and Destination for Duplicate and Compare operations. The left-most switch is the Source and the right-most is the Destination. No switches or all switches ON will result in an error "E0" code displayed, and a chirping of the tone generator.

Control Keys

RESET: A control key that cancels operation in progress, without altering the RAM Buffer. RESET clears the hex display.

CLEAR: A multi-function key used to clear data entries manually, decrement the address in the Read mode, or abort from an error in Duplicate and Program operations. See SECTION 10 for further information.

ENTER: A key used to initiate or repeat operations; also used to increment the address in the Read and Program modes.

Programmer Mode Keys (Active after Power ON or RESET)

READ/CMPR: A dual-function key. When two toggle switches (MASTER/BUFFER/COPY) are ON, this key acts to select the Compare mode in which the source contents are compared, one location at a time, against the destination contents. When only one toggle switch is ON the Read mode is selected. In the Read mode a non-volatile read is made of the Destination selected, one location at a time. In the Read mode, and when the BUFFER toggle switch is ON, a Read/Modify may be performed.

PROG/DUP: A dual-function key. When two toggle switches (MASTER/BUFFER/COPY) are ON, this key acts to select the Duplicate mode in which the source contents are copied into the destination. When only one toggle switch is ON the Program mode is selected. In the Program mode, data is written into either the Buffer or Copy PROM.

BLNK CHCK: A dual-function key. If one switch is ON (MASTER or COPY) a check of the PROM for the unprogrammed state will be performed. If any bit in the PROM is found to be in the programmed state, an error will be indicated. When used with the MASTER socket, the Blank Check mode may safely be used for incoming inspection of new PROMs, with no danger of accidental programming. If two switches are ON (MASTER and COPY or BUFFER and COPY) an illegal bit check will be performed on the Copy PROM. The Illegal Bit Check will determine from the erased state of the PROM, if the data in the Copy PROM can be successfully overwritten. This dual function does not apply to gang modules. If an attempt is made to Illegal Bit Check with a gang module an "E0" will be displayed. During the IBC operation, no attempt will be made to actually write data to the Copy PROM. Check PROM manufacturers specifications before overwriting any PROM.

EDIT/AUTO: A dual-function key used to select automatic sequencing of the Blank Check, Duplicate, and Compare modes. Two toggle switches (MASTER/BUFFER/COPY) must be in the ON position. Also used to select Buffer Edit functions when only the Buffer switch is in the ON position.

Hexadecimal keyboard: This keyboard has several dual-purpose switches. In addition to normal data entry, the keys are used to select modes for interface selection (see SECTION 15). Key C is used to select the Checksum mode. In this mode a checksum may be made over any defined address field on the Master or Copy PROM or the Buffer.

PERSONALITY MODULE DESCRIPTION

There are four types of plug-in Personality Modules for the M980 Programmer: Dedicated, Generic, Gang, and Special. Dedicated Modules are configured to program one or more devices with the same pinout. Generic Modules use Pinout Adapters and Configurators to program any of a manufacturer's generic line of PROMs. Gang Modules program multiple PROMs (usually 8) simultaneously. Special Modules include modules to program PALs and FPLAs. The M980 includes provisions for allowing the module to assume control of the programmer — some future Special Modules may use this feature.

In all cases, the Personality Modules interface with the Control Unit to provide the various voltages required to program and read a particular PROM, accommodating the various interface options of the Control Unit automatically.

Each module plugs into a Control Unit using three proven and reliable "D" type connectors. Each module has one (or more) COPY sockets and one MASTER socket. Programming voltages are never applied to the MASTER socket, thus protecting the Master PROM.

Dedicated Modules

Dedicated Modules are configured to program one or a few PROMs with identical pinouts. In some modules, a switch is used to permit one module to program two PROMs of the same family (e.g., 256x4 and 512x4), when the pinouts are compatible. In a few cases, the switch is used to set the operating conditions to satisfy multiple manufacturer's products.

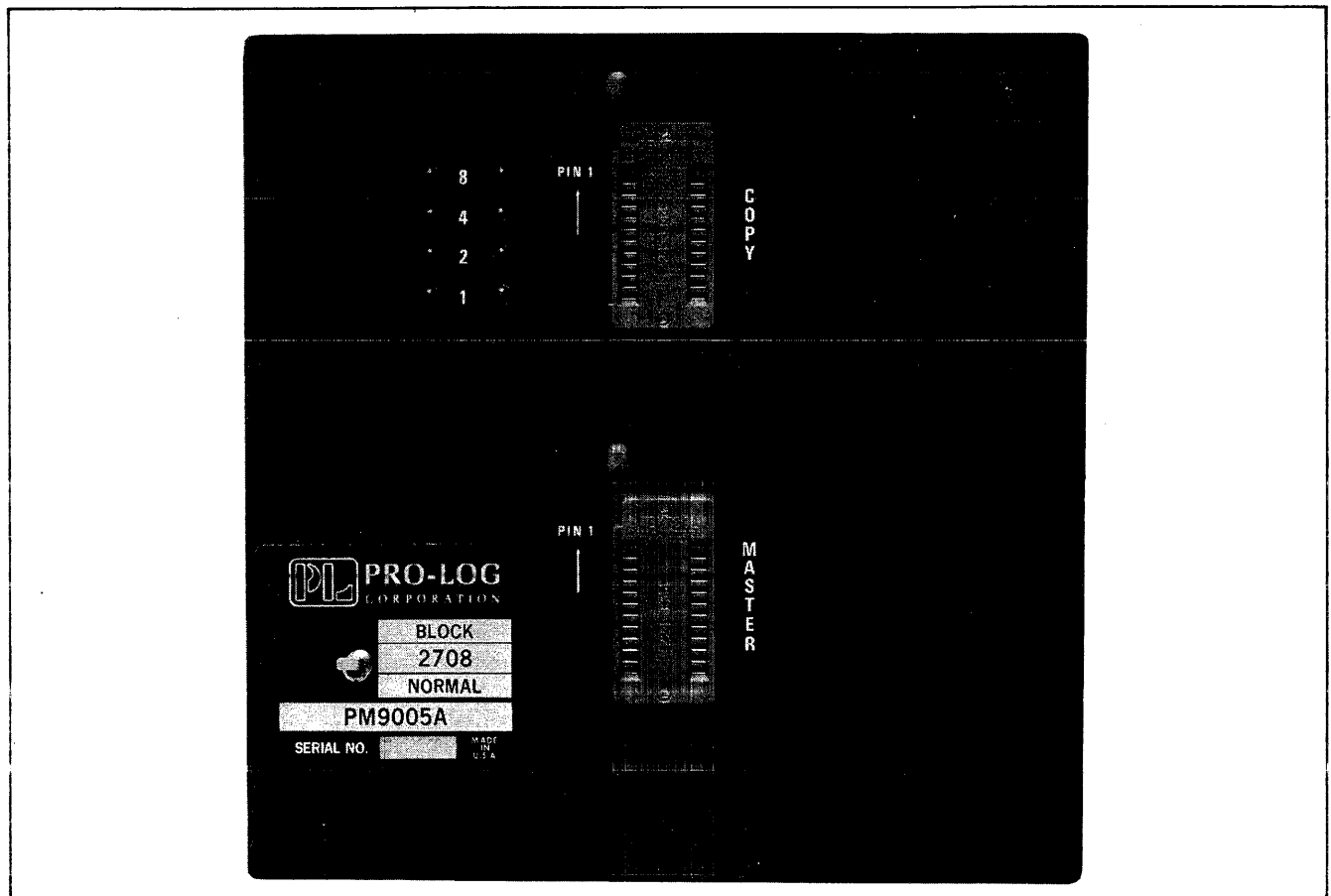

Figure 3-1 — Dedicated Personality Module

The COPY socket is located on the upper half of the module mounting plate: pin 1 is located next to the locking lever on the Zero Insertion Force (ZIF) socket. Binary lights are located to the left of the COPY socket and display the contents of the COPY socket. Either 4 or 8 lights are used, depending on the configuration of the PROM to be programmed. The MASTER socket is located on the lower half of the module mounting plate; its ZIF socket is indexed in the same manner as the COPY socket.

The handle affixed to the Personality Module plate is designed to assist in insertion and removal of the module from the Control Unit, by being mounted coaxially with the "D" type connectors. Removal of the module is accomplished with a direct upwards pull or slight back-and-forth motion. Insertion is the reverse, however, care should be exercised to ensure that the "D" type connector shells are mated properly before applying force to seat the module. When properly seated, the module plate is flat on the top of the Control Unit.

Note: Only insert or remove Personality Module when M980 is OFF.

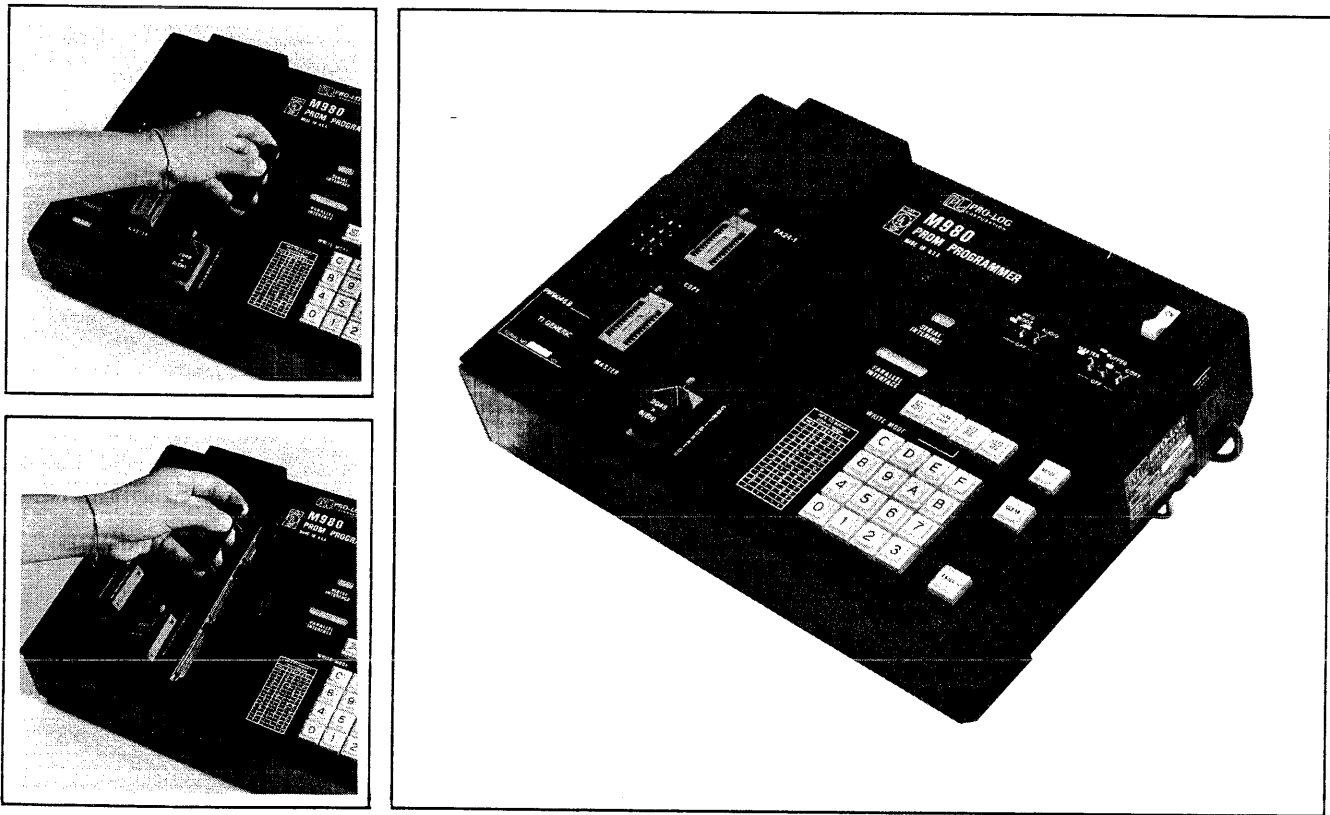

Figure 3-2 — Installation and Removal of Personality Module

Certain Dedicated Modules have special features or functions, and therefore have special operating instructions. These operating instructions are provided with each module.

Generic Modules

Generic Modules are designed to program all PROM types of a particular manufacturer, using adapters to conform to specific Pinouts and Configurators which allow the Control Unit to automatically accommodate different sizes and types of PROMS (e.g., 512x4, or 1024x8). The polarity of unprogrammed PROM locations and the PROM type (bipolar or MOS) are also contained in the Configurator. (Refer to the *PROM User's Guide* for specific Pinout Adapter and Configurator types for particular PROM types.)

Signals are passed from the base module (Figure 4-3) in the Pinout Adapter via two 25-pin D type connectors, the same reliable type used to connect the Personality Module to the Control Unit. The Configurator is mounted via a ZIF connector located on the bottom right of the module mounting plate. The Configurator must be mounted as shown below for the module to function properly. It should also be the proper size and type (e.g., 2048x8 (EH) for a 2716).

With the proper Pinout Adapter and Configurator installed, the Generic Module functions the same as a Dedicated Module of the same type. Additional Pinout Adapters and Configurators are constantly being added to accommodate the ever-broadening line of PROMs being manufactured.

Each Generic Module is furnished with a Configurator Chart that details the various Pinout Adapters and Configurators required to Program the manufacturer's line of PROMs. Those modules having special features or requiring special operating techniques are furnished with special operating instructions.

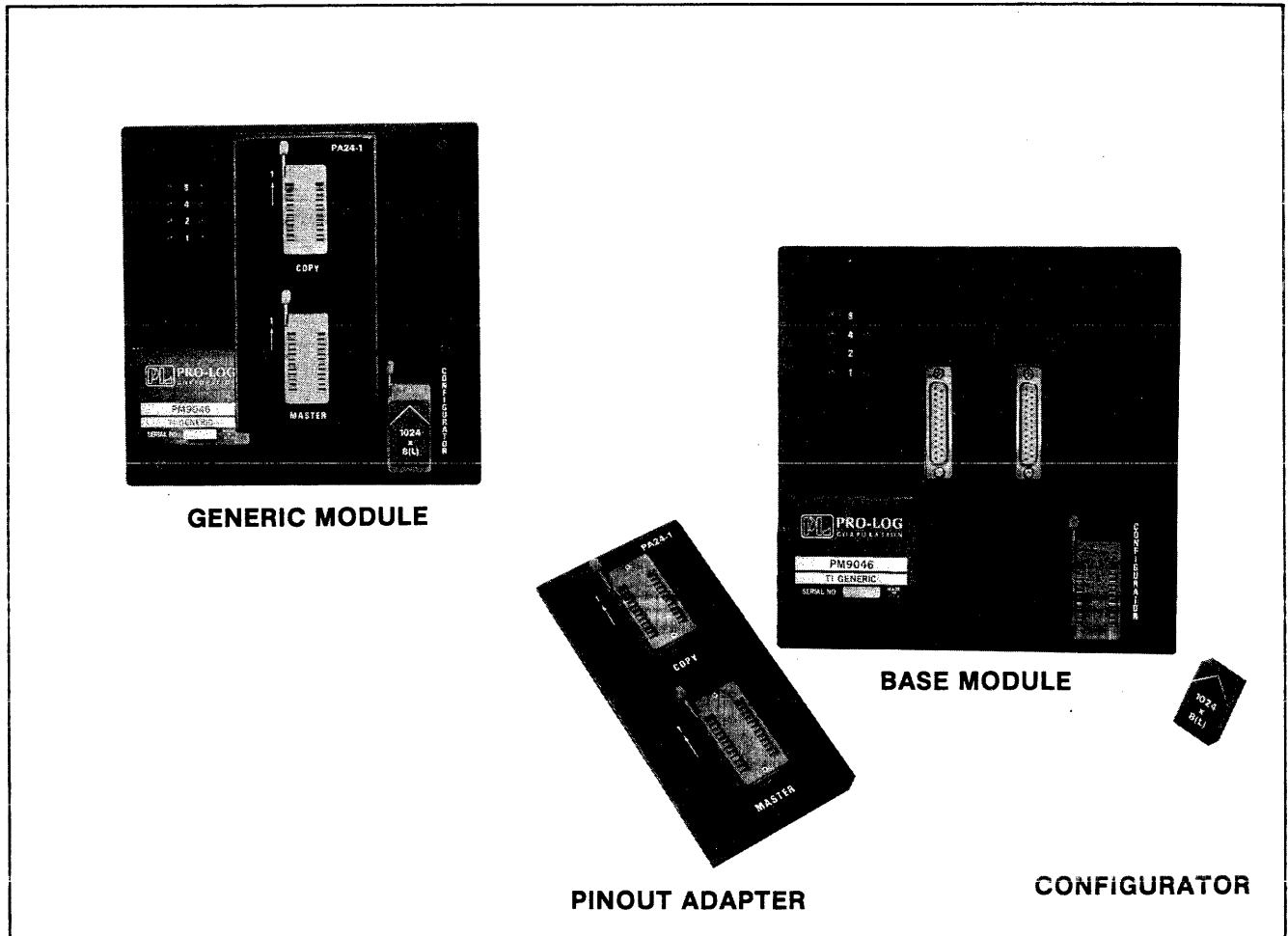

Figure 3-3 — Generic Personality Module

Gang Modules

Gang Modules are designed to program multiple PROMs simultaneously. The operation of each one is tailored to the PROM being programmed, and each one has its own special operating instructions.

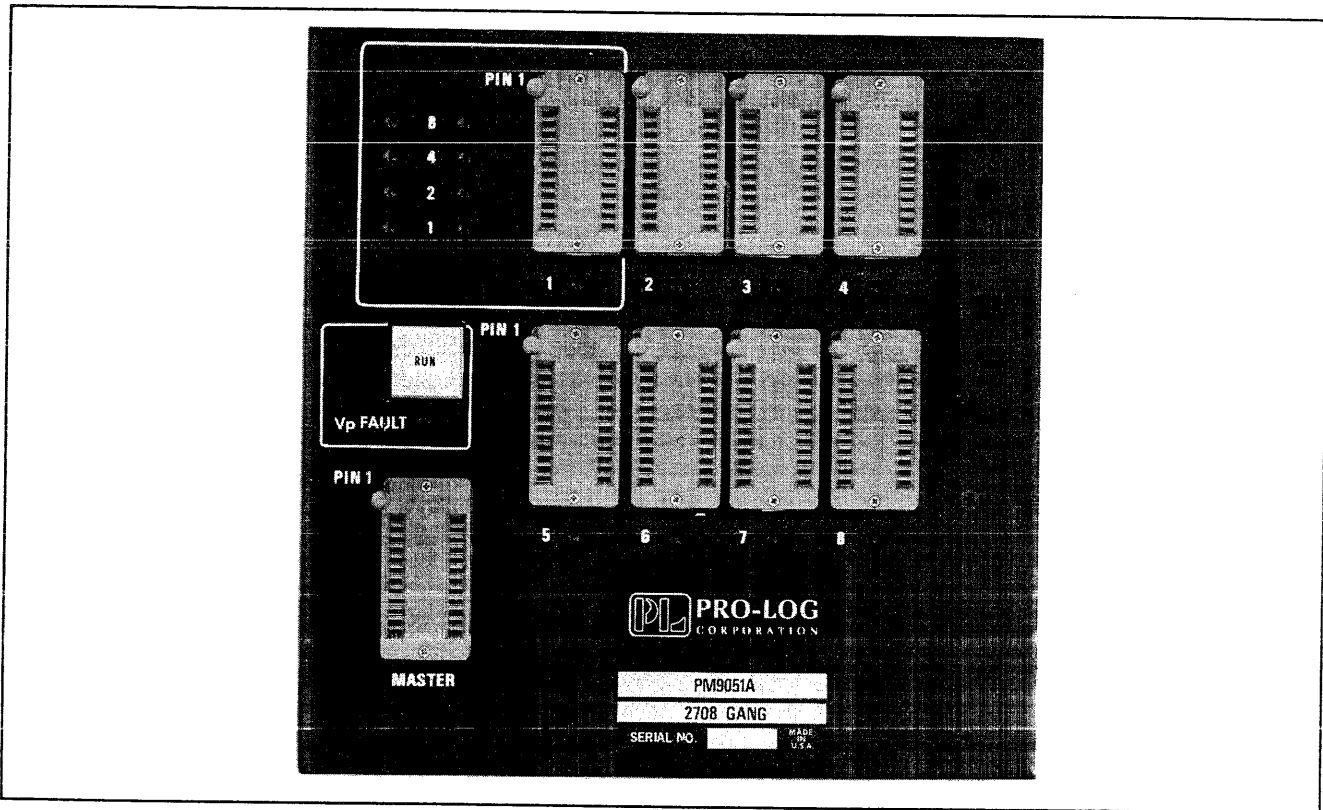

Figure 3-4 — Gang Personality Module

SPECIAL PERSONALITY MODULE INSTRUCTIONS

The M980 was designed to be compatible with all Personality Modules produced by Pro-Log. However, many of the software routines within the M980 Control Unit have been streamlined, and new modes of operation designed. As a result, some modules operate differently in the M980 than in other Series 90 programmers. Those differences are described here.

PM9005A

This module has two modes of operation: Block and Normal. When in Block Mode, all operations of the M980 are as described in the manual. In Normal Mode, programming does not occur unless data is entered for location 3FF. Therefore, all operations that involve programming the PROM must take this into account.

It is suggested that for ease of operation use only the Normal Mode when copying the entire PROM.

In Engineering Auto-Sequencing Mode (see SECTION 9) the Last Address must be 3FF.

In any programming mode, should errors be detected by the module, a special display sequence is begun. Refer to SECTION 11, Failure to Program Operations for further details.

PM9051A

The PM9051A is a gang 2708 module and requires data to be entered for location 3FF in order for programming to take place. For ease of operation, all programming and duplication operations should use a Last Address of 3FF.

In the Engineering Auto-Sequence Mode (see SECTION 9), the Last Address must be 3FF. In any programming mode, should errors be detected by the module, a special display sequence is begun. Refer to SECTION 11, Failure to Program, for further details.

PM9053A

In any programming mode, should errors be detected by the module, a special display sequence is begun. Refer to SECTION 11, Failure to Program Operations for further details.

PM9060A

The PM9060A is a TMS2716 Gang Module and requires data to be entered for location 7FF in order for programming to take place. For ease of operation, all programming and duplication operations should use the Last Address of 7FF.

In the Engineering Auto-Sequencing Mode (see SECTION 9), the Last Address must be 7FF. In any programming mode, should errors be detected by the module, a special display sequence is begun. Refer to SECTION 11, Failure to Program Operations, for further details.

PROM Handling

PROMs can be separated into two major categories — MOS and Bipolar. The MOS PROMs include all EPROMs and some CMOS fusible-link PROMs. (For more information, see Pro-Log's *PROM User Guide*). Care should be taken when handling MOS devices, as most of them are susceptible to damage due to static charges. When not plugged in, keep the PROMs on a pad of conductive foam.

Pro-Log has pioneered the two-socket approach, where the MASTER socket is never subjected to programming voltages, and so the chances of ruining a Master PROM are negligible.

ZIF Sockets

All Pro-Log Personality Modules use Zero Insertion Force (ZIF) sockets for both MASTER and COPY sockets. These sockets are activated by a handle located adjacent to pin 1 of the socket. When the handle is raised or in the up position the contacts are open and the PROM may be inserted. Lowering the handle engages the contacts and locks the PROM in place.

In sockets subjected to severe environmental conditions or after extensive use, the contacts may become corroded or bent. Periodic inspection of the sockets is suggested. The design of the modules permits the replacement of individual sockets should they become worn. (Contact Pro-Log's Customer Service if this is the case.)

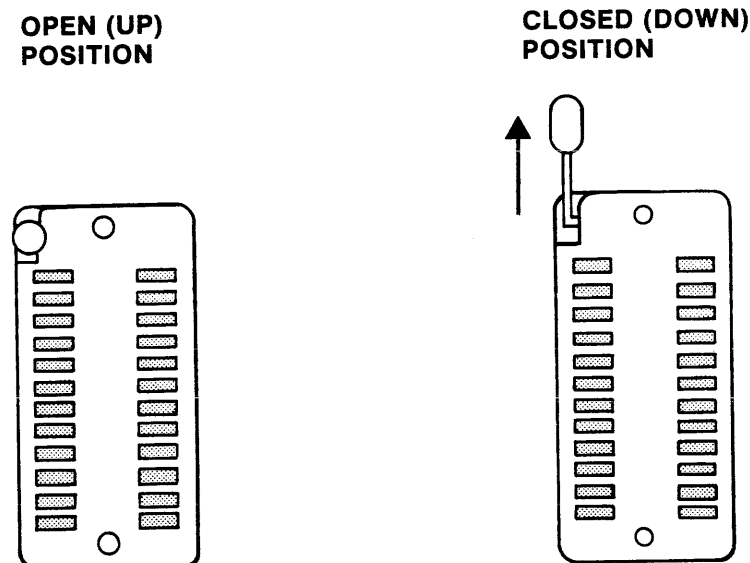

Figure 3-5 — ZIF Socket

ADDRESS FIELD DEFINITION

All keyboard operations with the exception of Manufacturing mode and some of the remote control options allow the operator to select a partial address field. If the operator does not select a partial field, the full address range will be used. The M980 refers to the Personality Module for Master and Copy PROM size.

Full Address Operation

Whenever a mode is selected, the hexadecimal display indicates the full PROM size to the operator by automatically displaying the First Address and the Last Address. The First Address is always all zeros and the Last Address is always ones, represented in hexadecimal. The hexadecimal values for the First and Last Addresses of all PROMs are given in Figure 4-1.

PROM SIZE	HEXADECIMAL FULL PROM FIELD ADDRESS	
	FIRST ADDRESS	LAST ADDRESS
16 by X	0	F
32 by X	00	1F
64 by X	00	3F
128 by X	00	7F
256 by X	00	FF
512 by X	000	1FF
1024 by X	000	3FF
2048 by X	000	7FF
4096 by X	000	FFF
8192 by X	0000	1FFF
16384 by X	0000	3FFF
32768 by X	0000	7FFF
65536 by X	0000	FFFF

Figure 4-1 — PROM Size Field Definition

The full address field indicates to the operator that all addresses of the PROM will be operated on. The operator may accept the full address or select a partial address.

Partial Address Operation

The operator has the option of changing the full address to a partial field before initiating the operation. A partial field may be as small as a single location and as large as the full address field.

When the First Address and Last Address appear in the hex display the operator can redefine the field by keying in a Start Address and End Address. The Start and End Addresses define the new field to be operated on. If the Start and End Addresses are equal a single location will be operated on.

The M980 can recall the previous operation Start and End Addresses by not depressing RESET between operations. After completing an operation, depress the next mode key and the previous Start and End Addresses are recalled. The operator may now perform another operation on the same address field.

EXAMPLE: Keyboard Strokes for an Operation over a Limited Field (for a 2Kx8 PROM)

1. Depress RESET. The 8 hex displays will be blank.

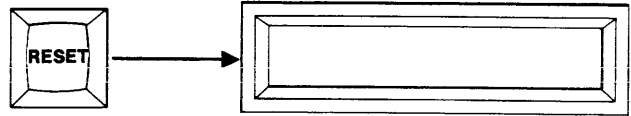

2. Depress the desired Mode key. The First and Last Addresses of the Copy PROM will be displayed.

3. If the entire address range is to be operated on, depress ENTER and the First and Last Addresses shown will be accepted as the Start and End Address for the operation. If a limited field is desired, continue.

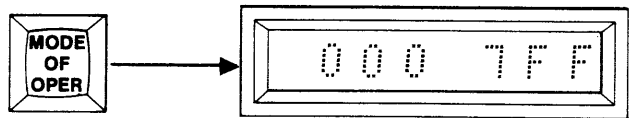

4. Using the hex keyboard, key in a new Start Address, MSD first. When the first key is depressed, the left-most displays will be blanked and the character corresponding to the key depressed will be displayed. Continue to key in the necessary characters to fill the Start Address displays. If the Last Address is to become the End Address, depress ENTER and the displayed address will be accepted as the Start and End Addresses for the operation.

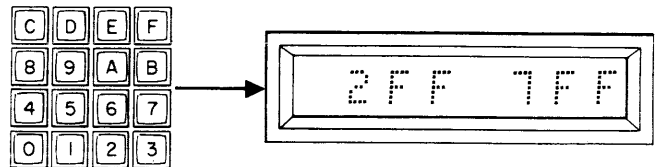
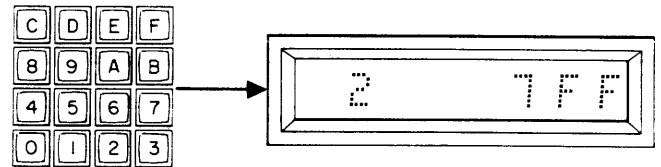

5. If a new End Address is needed, use the keyboard to key in a new End Address. When the next key is depressed, the right-most displays will be blanked and the character corresponding to the key depressed will be displayed. Continue until the entire address is keyed in. Depress ENTER and the displayed addresses will be accepted as the Start and End Addresses.

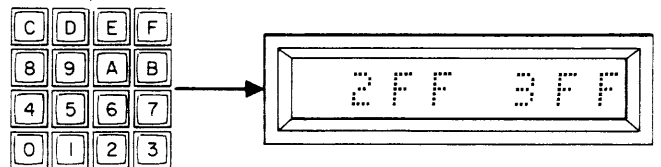
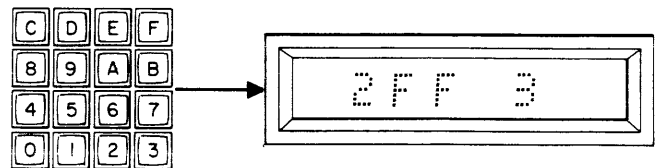

COPY AND MASTER SOCKET OPERATIONS

This section describes those modes involving the MASTER and COPY sockets. For a description of the modes involving the Buffer, see SECTION 6.

The COPY socket is used to program PROMs and other devices such as FPLAs and PALs. A PROM should not be put into the COPY socket unless it is to be programmed. A Copy PROM may be programmed from the keyboard, Master PROM, or Buffer. The Copy PROM can be read to the display one location at a time and it can be compared automatically with the Master PROM or Buffer. An automatic Checksum, Blank Check or Illegal Bit Check can be performed on the Copy PROM.

The MASTER socket is used to provide input from a Master PROM for writing to either the Copy PROM or Buffer. An automatic Checksum or Blank Check can be performed on the Master PROM.

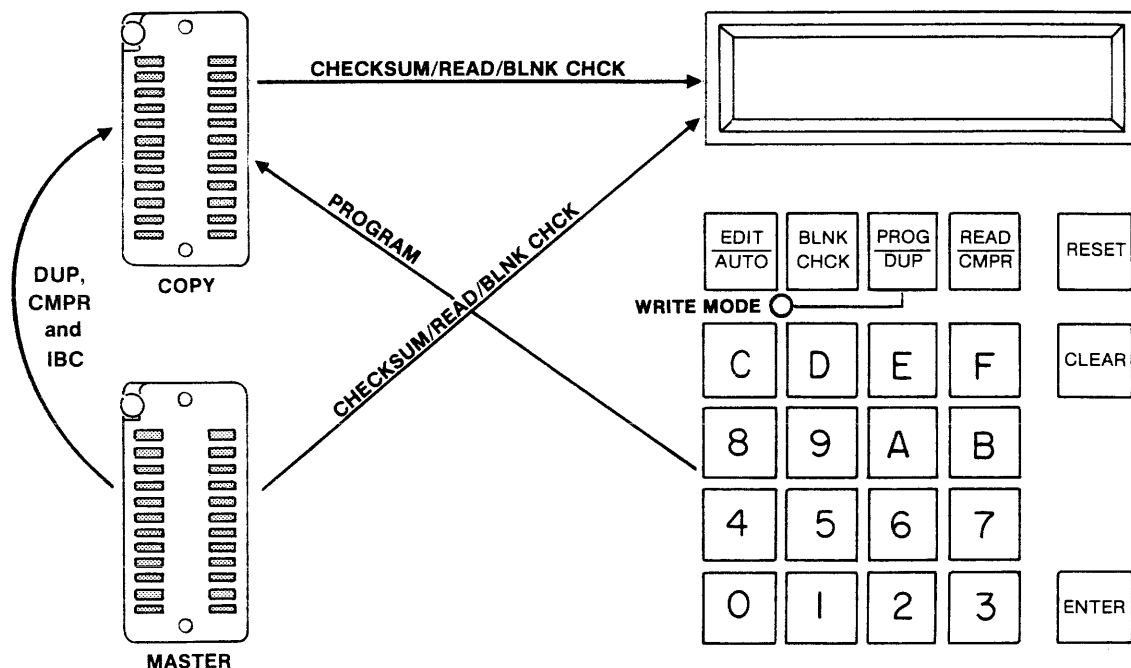

MASTER and COPY Socket Modes

RESET: Halts all operations. The RESET key is an overriding hardware input to the M980 that halts all operations and returns the programmer to the idle state. RESET can be used to stop any automatic operation. RESET does not affect the Buffer contents.

CLEAR: Corrects miskeyed address/data, decrements address in READ, aborts from Duplicate, Compare, and Program modes after failure. The CLEAR key is active to clear the displays only at those times when a hex key is used to key in address or data information. After the hex character is displayed, the CLEAR key may be used to clear that character and any characters to the left of the first character cleared. For additional uses of the CLEAR key, see SECTION 10.

Toggle Switch Selection

MANUFACTURING Mode. When ON, this toggle switch will reconfigure the M980 into a manufacturing PROM Programmer. When in the OFF position, the M980 becomes a multifunctional and versatile tool for programming any type of programmable device. See SECTION 8 for Manufacturing Mode operations.

AUDIO. This toggle switch activates a tone generator located inside the M980 Unit. When any error occurs, a warbling tone will be generated for approximately 4 seconds. When any operation is finished successfully, a steady tone will be generated for approximately 4 seconds. An operator error in mode selection will cause a high-pitched tone for 4 seconds.

MASTER/BUFFER/COPY (Source — Destination Concept)

If only one toggle switch is in the ON position, it becomes the Destination of the operation. If two toggle switches are in the ON position, the left-most switch becomes the Source and the right-most switch becomes the Destination. (If three switches are ON/OFF, and ENTER is depressed, an error code "EO" will be indicated in the display, and the warbling tone will sound.)

MASTER. When only this toggle switch is selected, the MASTER socket becomes the Destination. With two switches selected, the MASTER socket becomes the Source.

BUFFER. When this toggle switch is selected, the Buffer becomes the Source if the COPY switch is ON. At all other times the Buffer becomes the Destination.

COPY. When this toggle switch is selected, the COPY socket becomes the Destination.

**Programming a PROM using the M980 Keyboard
(example shown is for a 2Kx8 PROM)**

1. Select the switches as shown. Insert the appropriate Personality Module. Insert the PROM to be written into in the COPY socket. The Audio switch is optional.



2. Depress RESET. The 8 hex displays are blank.

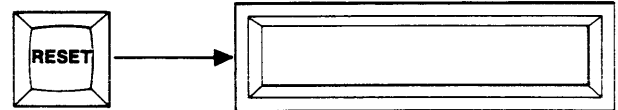

3. Depress PROG. The First and Last Addresses of the Copy PROM will be displayed.

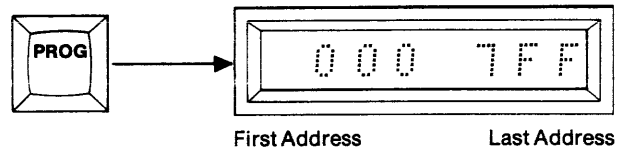

4. To operate over the entire contents of the Copy PROM, starting with the First Address, go to step 5. To operate over a limited field, use the hex keyboard to key in a new Start and End Address, MSD first.

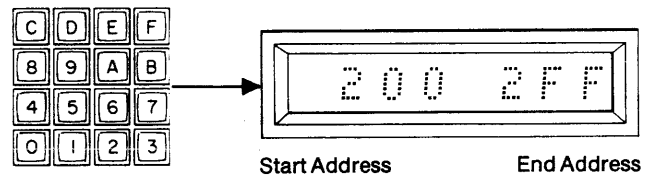

5. Depress ENTER. The displayed addresses will be accepted as the Start and End Addresses for the operation. The display will show the Start Address in the left-most displays. The Write Mode LED is lit.

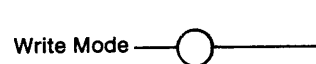
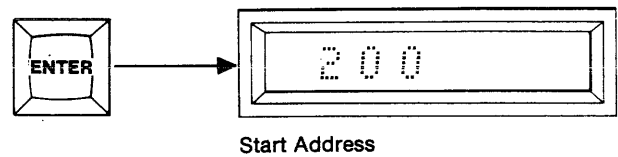

6. To program the address displayed, key in the desired data, MSD first, using the CLEAR key to correct mistakes. To step over a location continue to step 7.

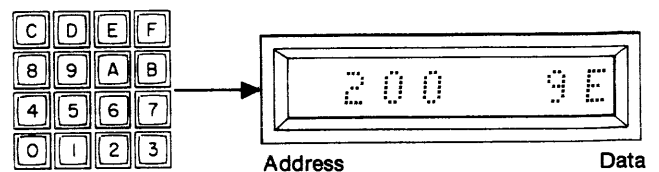

- Depress ENTER to initiate programming of the displayed data, or to step over an address without altering it. The next sequential address will be displayed. Repeat steps 6 and 7 for each address. If an address cannot be programmed with the data displayed, the M980 will not increment the address, and the error tone will sound, if Audio switch is ON. See Failure to Program Operations, SECTION 11.

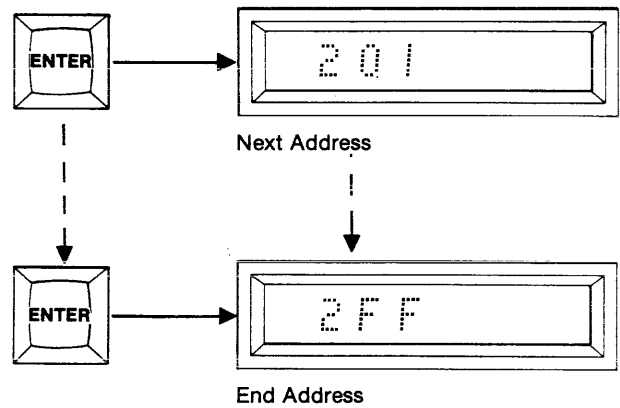

- When the End Address is displayed and step 6 and/or 7 are initiated, an "F" will appear to indicate that the Program mode has been performed over the entire Start and End Address fields.

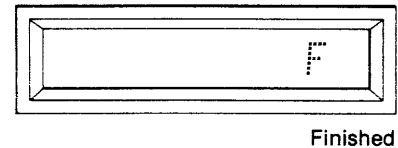

- To repeat the Program mode without Resetting, depress the ENTER key when the "F" is displayed. This will display the Start and End Address field previously used. You are now back at step 4. At this point you can either redefine the Start and End Address field or continue with the displayed Start and End Addresses.

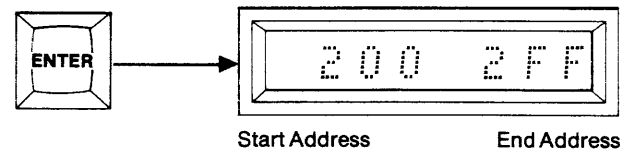

Summary of Programming a PROM using the M980 Keyboard

- Insert Personality Module, PROM, and select switches; MFG MODE(OFF) AUDIO(optional ON/OFF), MASTER (OFF), BUFFER (OFF), COPY (ON).
- Depress RESET. Displays are blank.
- Depress PROG/DUP. First and Last Addresses are shown.
- Optional. Redefine Start and End Addresses via the hex keyboard.
- Depress ENTER. Address shown accepted. Start Address displayed.
- Optional. Key in data to be programmed.
- Depress ENTER. This will program previously keyed data or step over the displayed address. Repeat for every address.
- Last Address reached and "F" is displayed to indicate Finished.
- Optional. Depress ENTER to show previous Start and End Addresses, and to return to step 4 and/or 5.

Reading a Copy PROM in the COPY Socket (example shown is for a 2Kx8 PROM)

1. Insert Personality Module and select switches as shown. Insert the PROM to be read into the COPY socket of the Personality Module. The AUDIO switch is optional.



2. Depress RESET. The 8 hex displays are blank.

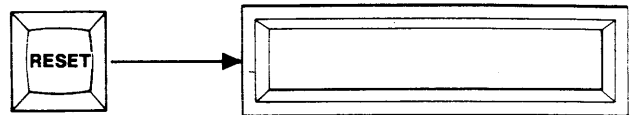

3. Depress READ. The 8 hex displays show the First and Last Addresses of the Copy PROM.

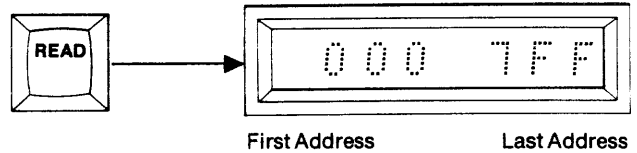

4. To Read the entire contents of the Copy PROM, starting with the First Address, go to step 5. To Read a limited field, use the hex keyboard to key in a new Start and End Address, MSD first.

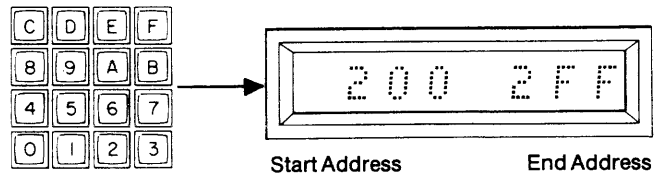

5. Depress ENTER. The displayed addresses will be accepted as the Start and End Addresses for the operation. The display will show the Start Address in the left-most displays. The data located at that address will be displayed in the right-most displays. Repeat step 5 and the next sequential address and data will be displayed. Repeat until the End Address is reached, Reset occurs, OR

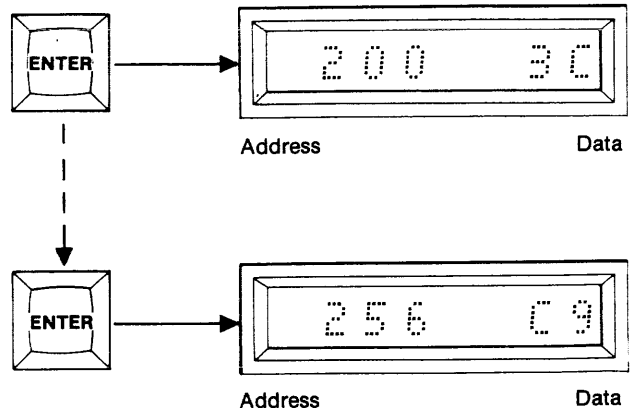

- Depress the CLEAR key during the Read operation. The address will be decremented and the data at that address will be displayed. The M980 can decrement past the defined Start Address. Wrap-around will occur if an all-zero address is reached and decremented again.

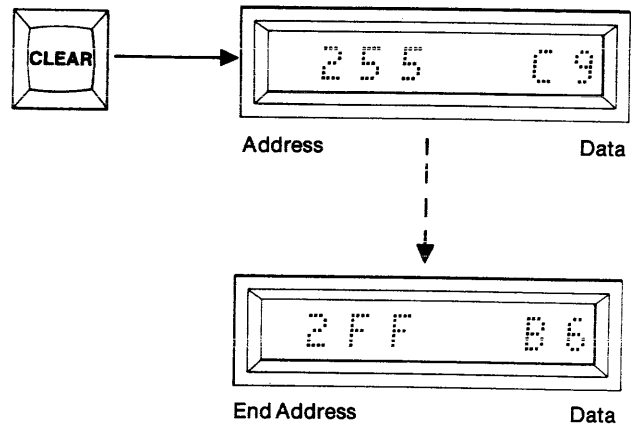

- When the End Address is reached, its data displayed, and ENTER is depressed, an "F" will appear in the display to indicate Finished.

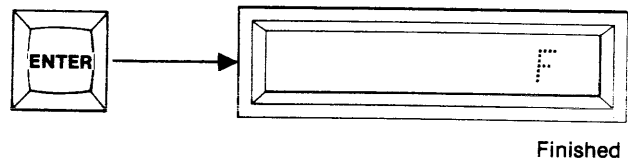

- To repeat the Read mode without resetting, depress the ENTER key when the "F" appears. The previous Start and End Addresses will be displayed. Continue with step 4 and/or 5.

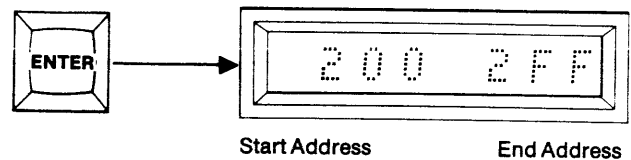

Summary of Reading the Copy PROM in the COPY Socket

- Insert Personality Module, PROM, and select switches; MFG MODE (OFF), AUDIO (optional ON/OFF), MASTER (OFF), BUFFER (OFF), COPY (ON).
- Depress RESET. Displays are blank.
- Depress READ/CMPR. First and Last Addresses are shown.
- Optional. Redefine Start and End Addresses via the hex keyboard.
- Depress ENTER. The Start Address and its corresponding data are displayed. Repeat for each sequential address OR
- Optional. Depress CLEAR to decrement the address and show its data.
- End address is reached and ENTER is depressed. An "F" is displayed for Finished.
- Optional. Depress ENTER to show previous Start and End Addresses, and to return to step 4 and/or 5.

Reading a Master PROM in the MASTER Socket (example shown is for a 2Kx8 PROM)

1. Insert Personality Module and select switches as shown. Insert the device to be read into the MASTER socket of the Personality Module. The AUDIO switch is optional.

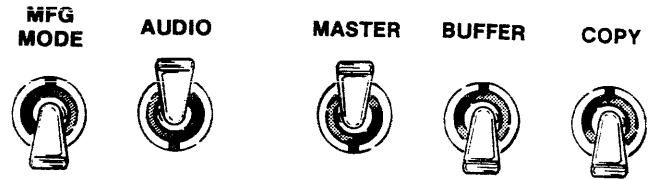

2. Depress RESET. The 8 hex displays are blank.

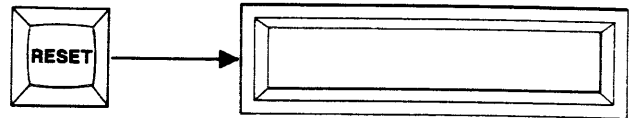

3. Depress READ. The 8 hex displays show the First and Last Addresses of the Master PROM.

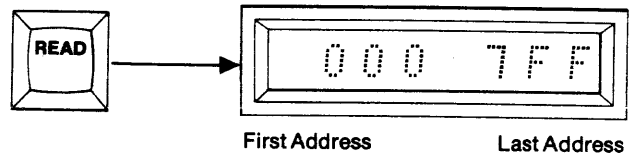

4. To Read the entire contents of the Master PROM, starting with its First Address, go to step 5. To Read a limited address field, use the hex keyboard to key in a new Start Address, MSD first. Repeat for End Address.

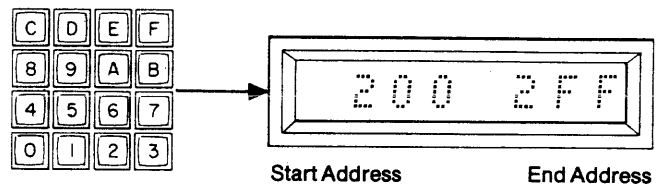

5. Depress ENTER. The M980 will accept the displayed data as the Start and End Addresses for the operation. The display will show the Start Address in the left-most displays. The data located at that address will be displayed in the right-most displays. Repeat step 5 and the next sequential address and data will be displayed. Repeat until the End Address is reached, Reset occurs, OR

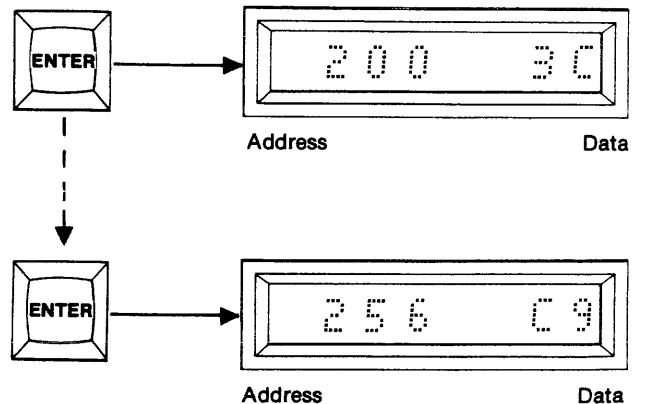

6. Depress the CLEAR key during the Read operation. The address will be decremented and the data at that address will be displayed. The M980 can decrement past the defined Start Address. Wrap-around will occur if an all-zero address is reached and decremented again.

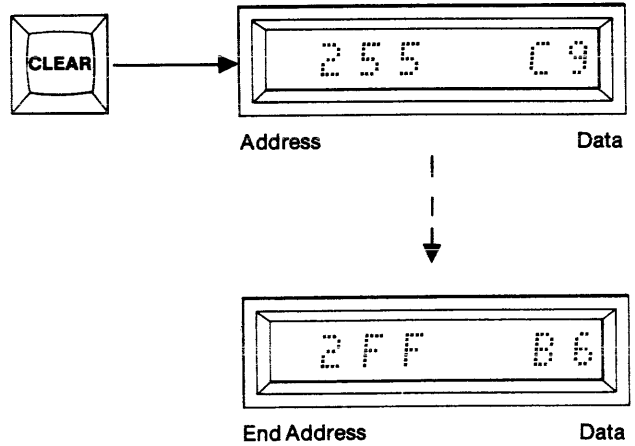

7. When the End Address is reached, its data displayed, and ENTER is depressed, an "F" will appear in the display to indicate Finished.

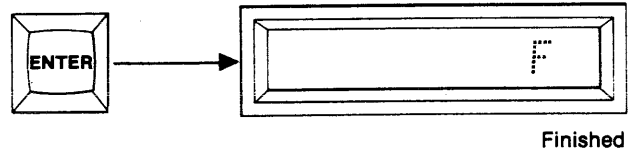

8. To repeat the Read mode without resetting, depress the ENTER key when the "F" appears. The previous Start and End Addresses will be displayed. Continue with step 4 and/or 5.

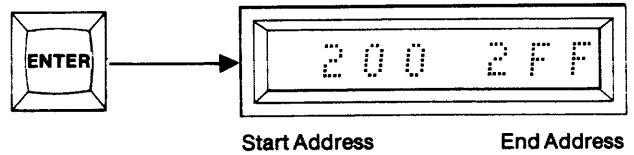

Summary of Reading the Master PROM in the Master Socket

1. Insert Personality Module, PROM, and select switches; MFG MODE (OFF), AUDIO (optional ON/OFF), MASTER (ON), BUFFER (OFF), COPY (OFF).
2. Depress RESET. Displays are blank.
3. Depress READ. First and Last Addresses are shown.
4. Optional. Redefine Start and End Addresses.
5. Depress ENTER. The Start Address and its corresponding data are displayed. Repeat each sequential address OR
6. Optional. Depress CLEAR to decrement the address and show its data.
7. End Address is reached and ENTER is depressed. An "F" is displayed to indicate Finished.
8. Optional. Depress ENTER to show previous Start and End Addresses, and to return to step 4 and/or 5.

Duplicating a PROM from a Master PROM (example shown is for a 2Kx8 PROM)

1. Select the switches as shown. Insert the appropriate Personality Module. Insert the PROM to be used as Master in the MASTER socket. Insert the PROM to be written into in the COPY socket. The AUDIO switch is optional.



2. Depress RESET. The 8 hex displays are blank.

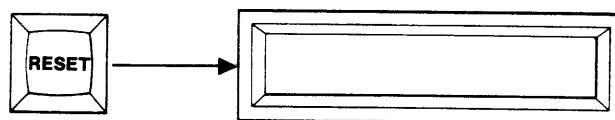

3. Depress DUP. The First and Last Addresses of the Master and Copy PROM will be displayed.

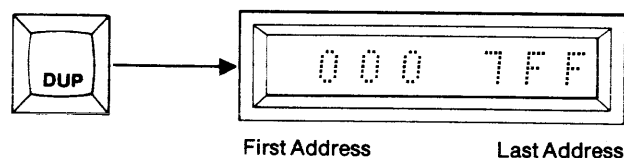

4. To Duplicate the entire contents of the Master PROM into the Copy PROM, starting with the First Address, go to step 5. To Duplicate over a limited field, use the hex keyboard to key in a new Starting and Ending Address, MSD first.

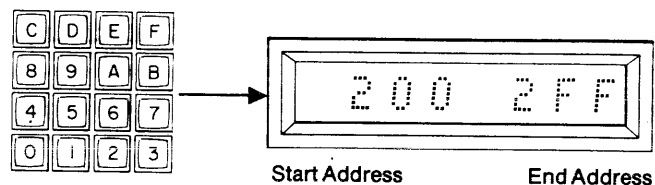

5. Depress ENTER. The displayed addresses will be accepted as the Start and End Addresses for the operation. "C1" will be displayed to indicate Change #1. If you do not wish to change any of the data being duplicated go to step 8.

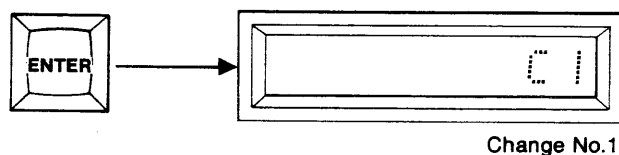

6. You may now substitute new data for up to eight addresses in the defined address field. Using the hex keyboard, key in the address at which you wish to substitute data. The address will be displayed in the left-most displays. Now key in the data you wish to substitute. The data will be displayed in the right-most displays. If an incorrect character is keyed in, use the CLEAR key to correct it.

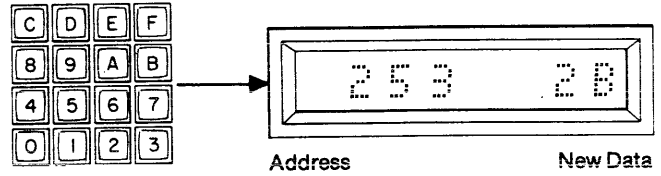

7. Depress ENTER. The change will be stored in scratch pad RAM and the next change will be displayed (C2, C3, C4, ...C8). Repeat step 6 for up to 8 changes or go to step 8. Step 8 will start automatically after the eighth change is keyed in and ENTER is depressed.

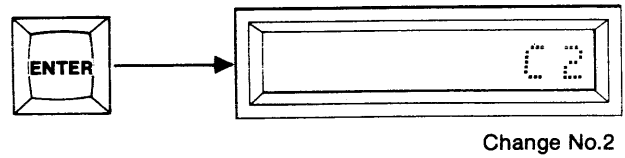

8. Depress ENTER. The display will show "D AAA" to indicate that the Duplicate (D) mode is Active (AAA). The Write Mode LED is lit. When the Duplicate mode is finished "D F" will be displayed. The Write Mode LED is extinguished.

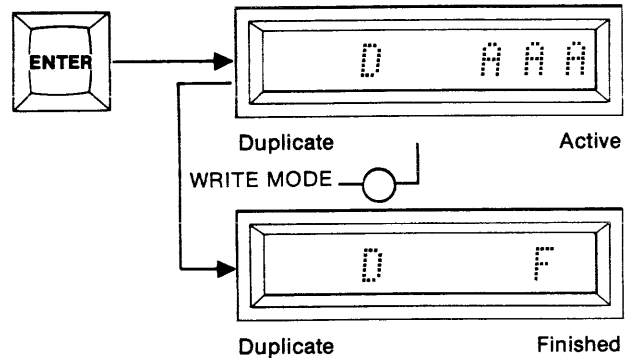

9. To repeat the Duplicate mode without resetting, depress ENTER again. This will display the previous Start and End Addresses and return you to step 4 and/or 5. After step 5, the change code will indicate the number of changes entered previously, plus one. Additional changes may now be entered if desired.

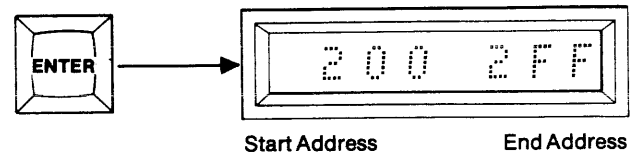

10. If an error should occur, the address and the data of the Master PROM where the error occurred will be displayed. Depressing key C will show the copy data at that address. Depressing key A will show the master data again.

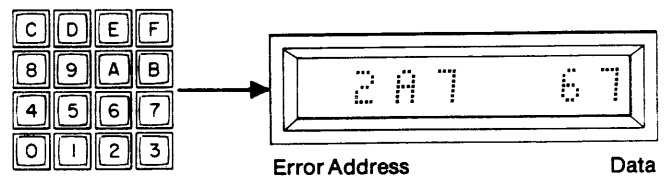

11. Depress ENTER to resume the Duplicate operation and to return to step 8; OR depress CLEAR to abort to Duplicate Finished. See Failure to Program Operations, SECTION 11.

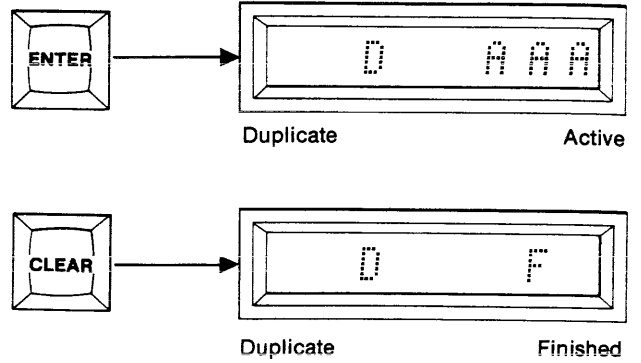

Summary of Duplicating a PROM from a Master PROM

1. Insert Personality Module, Master and Copy PROMs, and select switches; MFG MODE (OFF), AUDIO (optional ON/OFF), MASTER (ON), BUFFER (OFF), COPY (ON).
2. Depress RESET. Displays are blank.
3. Depress PROG/DUP. First and Last Addresses are displayed.
4. Optional. Key in new Start and/or End Addresses.
5. Depress ENTER. C1 is displayed asking for change #1. If no changes go to step 8.
6. Optional. Key in substitution address and data.
7. Depress ENTER. C2, C3, C4, ...C8, will be displayed asking for more changes. Repeat step 6 for more changes or go to step 8.
8. Depress Enter. "D AAA" will be displayed for DUP ACTIVE. "D F" will be displayed for Dup Finished.
9. Optional. Depress ENTER to recall Start and End Addresses and go to step 4 and/or 5 if you wish to repeat the Duplicate mode.
10. If an error should occur the address and data of the error will be displayed. Key A will show master data and Key C will show copy data.
11. Optional. Depress ENTER to continue with DUP after an error or depress CLEAR to abort to Dup Finished, without losing original address limits and changes.

Comparing a Copy Prom with a Master PROM (example shown is for a 2Kx8 PROM)

1. Select the switches as shown. Insert the appropriate Personality Module. Insert the PROM to be used as Master in the MASTER socket. Insert the PROM to be written into the COPY socket. The AUDIO switch is optional.

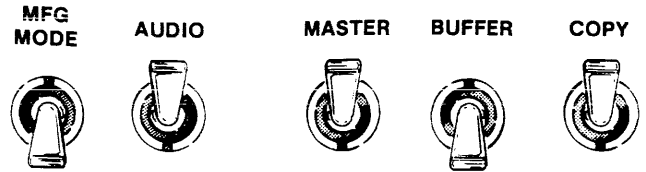

2. Depress RESET. The 8 hex displays are blank.

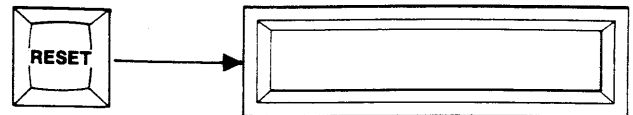

3. Depress CMPR. The First and Last Addresses of the Master and Copy PROMs will be displayed.

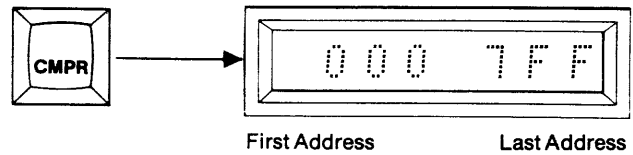

4. To Compare the entire contents of the Master PROM against the Copy PROM, starting with the First Address, go to step 5. To Compare a limited field, use the hex keyboard to key in a new Start and End Address, MSD first.

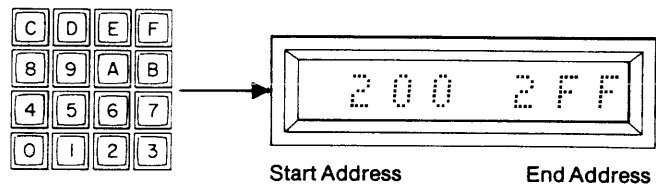

5. Depress ENTER. The displayed addresses will be accepted as the Start and End Addresses for the operation. "C AAA" will be displayed to indicate Compare (C) Active (AAA). When the Compare mode is finished, "C F" will be displayed for Compare (C) Finished (F).

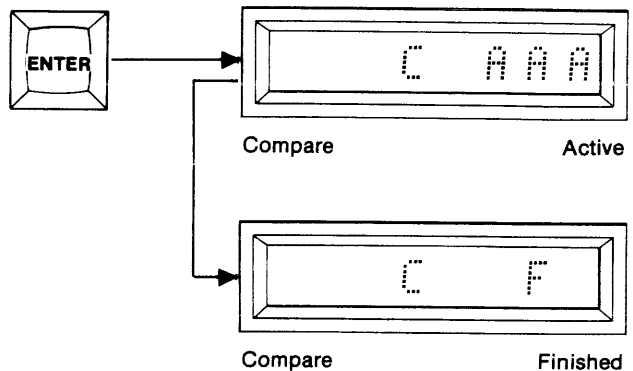

6. To repeat the Compare mode after "C F" is displayed, depress ENTER. The previous Start and End Addresses will be displayed. Continue with step 4 and/or 5.

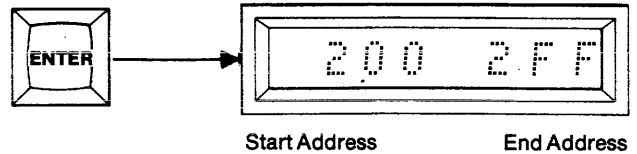

7. If a non-compare occurs, the address and data of the Master PROM where the non-compare occurred will be displayed. Key C will display the copy data and key A will display the master data.

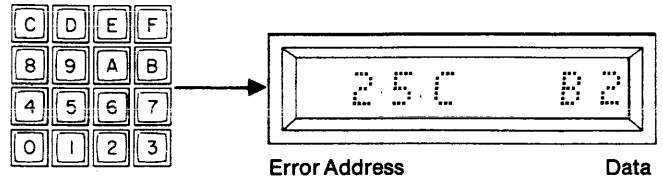

8. Depress ENTER to continue with the Compare operation and to return to step 4 and/or 5; OR depress CLEAR to abort to Compare Finished.

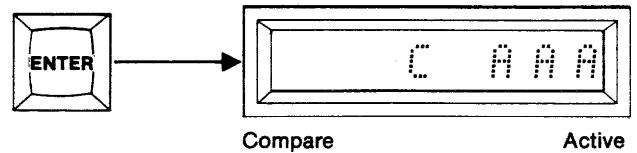

or

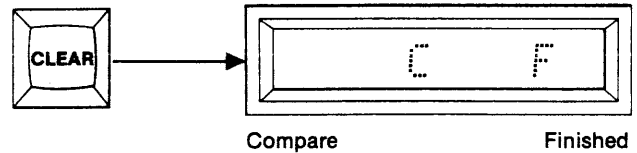

Summary of Comparing a Copy PROM with a Master PROM

1. Insert Personality Module, Master and Copy PROMs, and select switches; MFG MODE (OFF), AUDIO (optional ON/OFF), MASTER (ON), BUFFER (OFF), COPY (ON).
2. Depress RESET. The hex displays are blank.
3. Depress READ/CMPR. First and Last Addresses are displayed.
4. Optional. Key in new Start and/or End Addresses.
5. Depress ENTER. "C AAA" is displayed. When finished "C F" is displayed.
6. Optional. Depress ENTER to repeat operation over previously selected address field.
7. If a non-compare occurs the address and data of the Master PROM are displayed. Key C displays copy data and key A displays master data.
8. Optional. Depress ENTER to continue Comparing or depress CLEAR to abort to Compare Finished, without losing original address limits.

Performing a Checksum on a Master PROM (example shown is for a 2Kx8 PROM)

1. Select the switches as shown. Insert the appropriate Personality Module. Insert the PROM to be used as Master PROM in the MASTER socket. The AUDIO switch is optional.

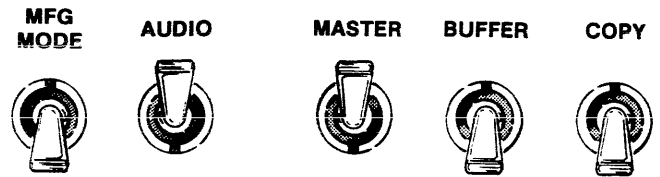

2. Depress RESET. The 8 hex displays are blank.

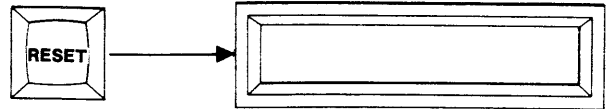

3. Depress Key C. The Start and End Addresses of the Master PROM will be displayed.

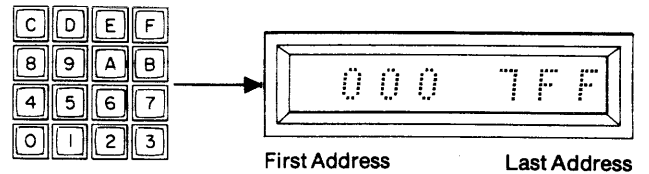

4. To Checksum the entire contents of the Master PROM, starting with the Start Address, go to step 5. To Checksum over a limited field, use the hex keyboard to key in a new Start and End Address, MSD first.

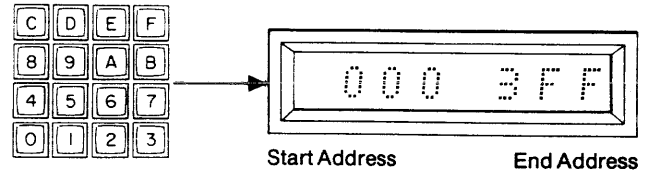

5. Depress ENTER. The M980 will accept the displayed data as the Start and End Addresses for the operation. The display will show "CC AAA" to indicate Checksum (CC) Active (AAA). When the Checksum is complete, the six digit hex equivalent will be displayed with the MSD's that are not used indicating 0's.

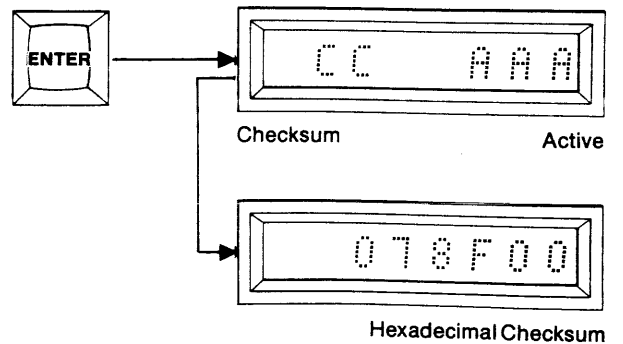

Summary of Performing a Checksum on a Master PROM

1. Insert Personality Module, Master PROM, and select switches; MFG MODE (OFF), AUDIO (optional ON/OFF), MASTER (ON), BUFFER (OFF), COPY (OFF).
2. Depress RESET. Displays are blank.
3. Depress key C. First and Last Addresses are displayed.
4. Optional. Redefine Start and End Addresses.
5. Depress ENTER. "CC AAA" is displayed while active. Hexadecimal Checksum is displayed when finished.

**Performing a Checksum on a Copy PROM
(example shown is for a 2Kx8 PROM)**

1. Select the switches as shown. Insert the appropriate Personality Module. Insert the Copy PROM into the COPY socket of the Personality Module. The AUDIO switch is optional.

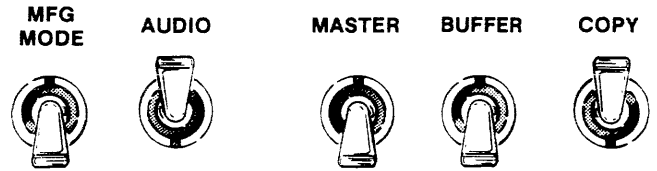

2. Depress RESET. The 8 hex displays are blank.

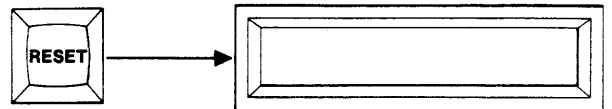

3. Depress KEY C. The First and Last Addresses of the Copy PROM will be displayed.

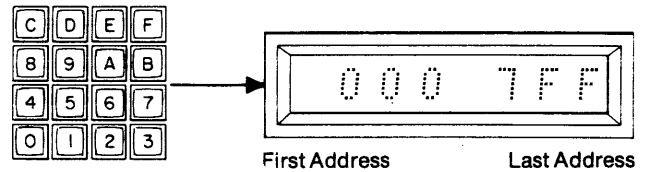

4. To Checksum the entire contents of the Copy PROM, starting with the First Address, go to step 5. To Checksum over a limited field, use the hex keyboard to key in a new Start and End Address, MSD first.

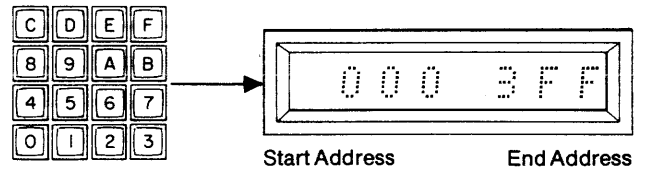

5. Depress ENTER. The M980 will accept the displayed data as the Start and End Addresses for the operation. The display will show "CC AAA" to indicate Checksum (CC) Active (AAA). When the Checksum is complete, the six digit hex equivalent will be displayed.

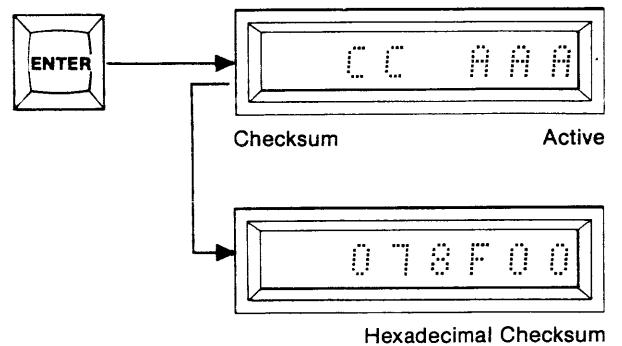

Summary of Performing a Checksum on a Copy PROM

1. Insert Personality Module, Copy PROM, and select switches; MFG MODE (OFF), AUDIO (optional ON/OFF), MASTER (OFF), BUFFER (OFF), COPY (ON).
2. Depress RESET. Displays are blank.
3. Depress key C. First and Last Addresses are displayed.
4. Optional. Redefine Start and End Addresses.
5. Depress ENTER. "CC AAA" is displayed while active. Hexadecimal Checksum is displayed when finished.

**Performing a Blank Check on a Master PROM
(example shown is for a 2Kx8 PROM)**

1. Select the switches as shown. Insert the appropriate Personality Module. Insert the PROM to be Blank Checked into the MASTER socket. The AUDIO switch is optional.

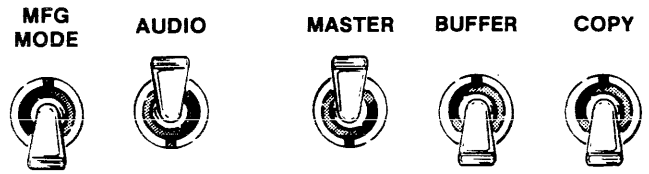

2. Depress RESET. The 8 hex displays are blank.

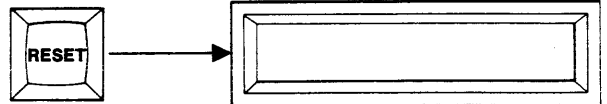

3. Depress BLNK CHCK. The First and Last Addresses of the Master PROM will be displayed.

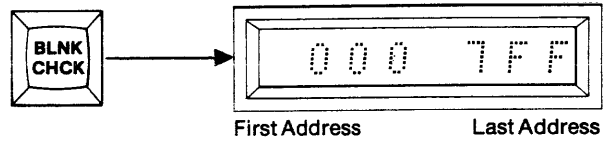

4. To Blank Check the entire contents of the Master PROM, starting with the first location, go to step 5. To Blank Check a limited field, continue. Use the hex keyboard to key in a new Start Address, MSD first. Repeat for the Ending Address.

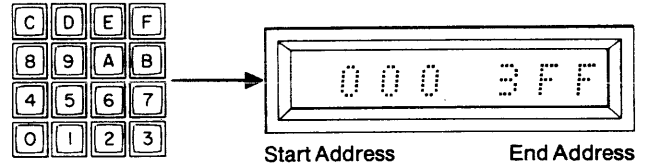

5. Depress ENTER. The M980 will accept the displayed data as the Start and End Addresses for the operation. The display will show "B AAA" to indicate Blank Check (B) Active (AAA). "B F" will be displayed for Blank Check Finished.

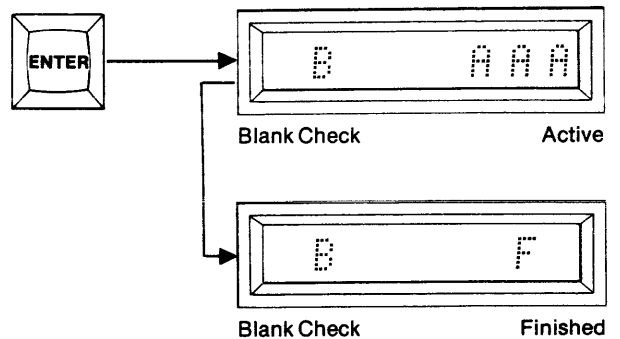

6. To repeat the Blank Check operation, depress ENTER when "B F" appears. The previous Start and End Addresses will be displayed and you may continue with step 4 and/or 5.

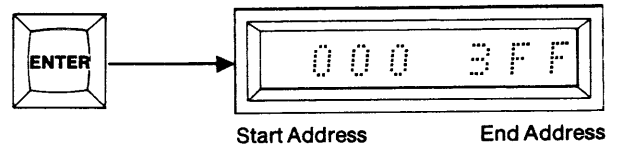

7. If a non-blank address is found, the address and data will be displayed. Return to step 5 to continue or RESET.

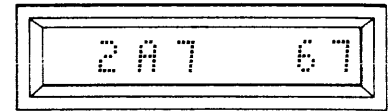

Non-blank Address

Data

Summary of Performing a Blank Check on a Master PROM

1. Insert Personality Module, Master PROM, and select switches; MFG MODE (OFF), AUDIO (optional ON/OFF), MASTER (ON), BUFFER (OFF), COPY (OFF).
2. Depress RESET. Displays are blank.
3. Depress BLNK CHCK. First and Last Addresses of Master PROM are displayed.
4. Optional. Redefine Start and End Addresses.
5. Depress ENTER. "B AAA" is displayed while active. "B F" displayed for Blank Check Finished.
6. Optional. Depress ENTER to repeat Blank Check and go to step 4 and/or 5.
7. If non-blank address is found, it will be displayed. Return to step 5 to continue or RESET.

Performing a Blank Check on a Copy PROM (example shown is for a 2Kx8 PROM)

1. Select the switches as shown. Insert the appropriate Personality Module. Insert the Copy PROM to be Blank Checked into the COPY Socket. The AUDIO switch is optional.



2. Depress RESET. The 8 hex displays are blank.

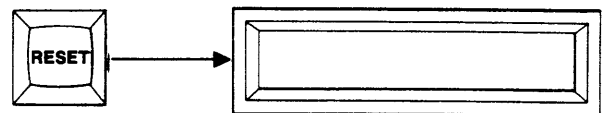

3. Depress BLNK CHCK. The First and Last Addresses of the Copy PROM will be displayed.

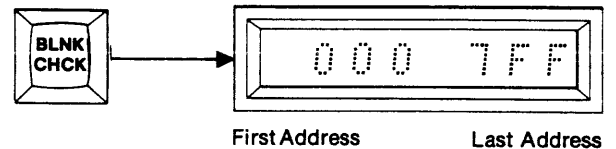

4. To Blank Check the entire contents of the Copy PROM, starting with the first location, go to step 5. To Blank Check a limited field, continue. Use the hex keyboard to key in a new Start Address, MSD first. Repeat for the End Address.

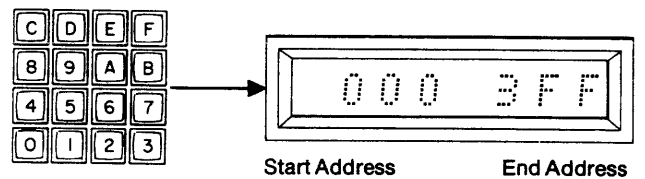

5. Depress ENTER. The M980 will accept the displayed data as the Start and End Addresses for the operation. The display will show "B AAA" to indicate Blank Check (B) Active (AAA). "B F" will be displayed for Blank Check Finished.

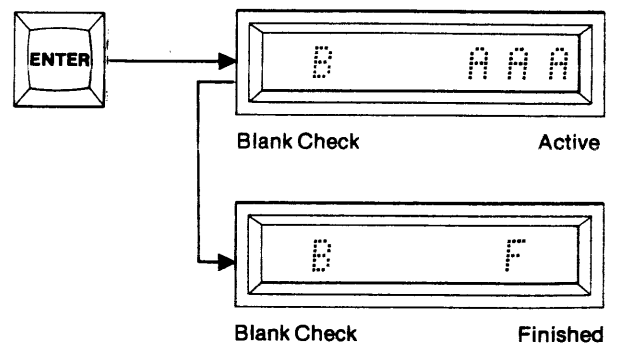

6. To repeat the Blank Check operation, depress ENTER when "B F" appears. The previous Start and End Address will be displayed and you may continue with step 4 and/or 5.

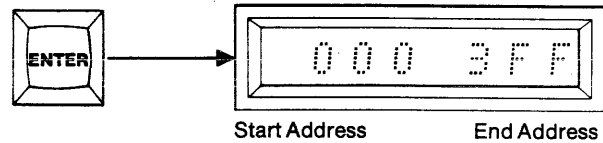

7. If a non-blank address is found, the address and data will be displayed. Return to step 5 to continue or RESET.

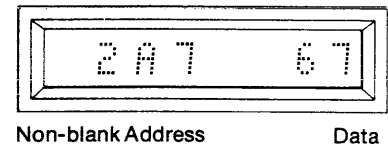

Summary of Performing a Blank Check on a Copy PROM

1. Insert Personality Module, Copy PROM, and select switches; MFG MODE (OFF), AUDIO (optional ON/OFF), MASTER (OFF), BUFFER (OFF), COPY (ON).
2. Depress RESET. Displays are blank.
3. Depress BLNK CHCK. First and Last Addresses of Copy PROM are displayed.
4. Optional. Redefine Start and End Addresses.
5. Depress ENTER. "B AAA" is displayed while active. "B F" displayed for Blank Check Finished.
6. Optional. Depress ENTER to repeat Blank Check and go to step 4 and/or 5.
7. If non-blank address is found, it will be displayed. Return to step 5 to continue or RESET.

Performing an Illegal Bit Check on a Copy PROM from the Master PROM (example shown is for a 2Kx8 PROM)

The Illegal Bit Check operation checks for the possibility of overwriting the PROM in the copy socket over the defined field with data from the master PROM. Illegal Bit Check determines the erased state of the PROM under consideration from the lookup table in the personality module. If the copy PROM has a nonerased location that has an erased state to be written, an error condition will occur. No attempt will be made to write data to the copy PROM during Illegal Bit Check.

1. Select switches as shown.



2. Depress RESET. The 8 hex displays are blank.

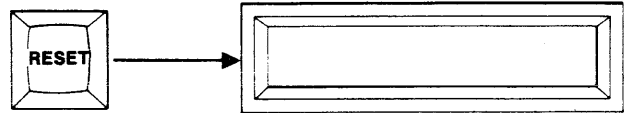

3. Press BLNK CHCK. The first and last addresses of the Copy PROM will be displayed.

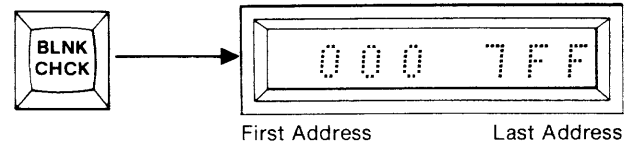

4. To perform an Illegal Bit Check (IBC) over displayed field, go to step 5. To change address field, use keyboard to enter new Start and End Addresses. See SECTION 3 for more details. Use CLEAR key for corrections. When the complete field is defined, go on to the next step.

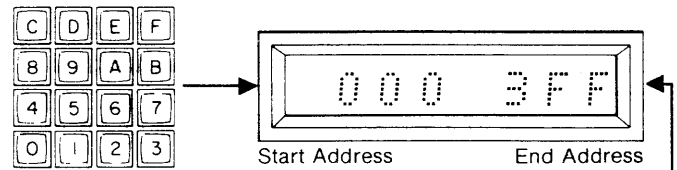

5. Depress ENTER. The M980 will accept the Start/End Address displayed as the field over which the Illegal Bit Check will be performed. "B AAA" shows that IBC is active. "B F" shows that IBC has been completed.

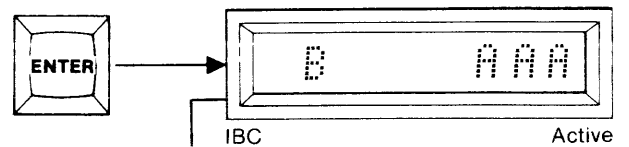

6. To repeat IBC operation, depress ENTER after "B F" appears. The previous Start/End Address will be displayed. Continue at step 4.

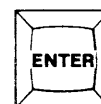
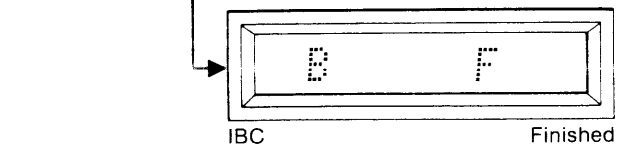

- The Illegal Bit Check is performed at sequential addresses beginning with the Start Address. If a location is found that can't be overwritten, that address is shown along with the Master data. Depress key "C" on the hex keyboard to display Copy data. Depress "A" to restore Master data. Depress ENTER to continue IBC operation or CLEAR to force finish. Then depress ENTER to continue at Step 4.

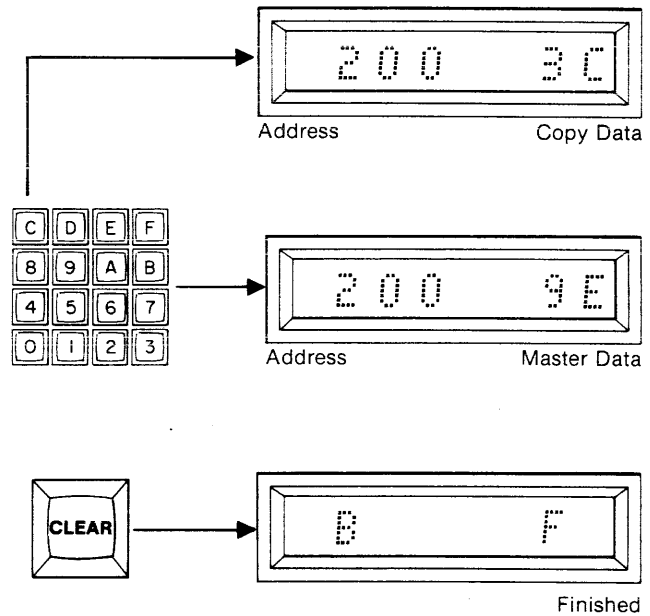

Summary of Illegal Bit Checking a Copy PROM from a Master PROM

- Insert Personality Module, Master and Copy PROMs, and select switches; MFG MODE (OFF), AUDIO (optional ON/OFF), MASTER (ON), BUFFER (OFF), COPY (ON).
- Depress RESET The hex displays are blank.
- Depress BLNK CHCK. First and Last Addresses are displayed.
- Optional. Key in new Start and/or End Address.
- Depress ENTER. "B AAA" is displayed. When finished "B F" is displayed.
- Optional. Depress ENTER to repeat operation over previously selected address field.
- If an illegal condition occurs, the address and data of the Master PROM are displayed. Key C displays copy data and key A displays master data.
- Optional. Depress ENTER to continue Illegal Bit Check or depress CLEAR to abort to IBC Finished, without losing original address limits.

SUMMARY OF BUFFER OPERATIONS TO/FROM A COPY OR MASTER PROM

The CMOS RAM Buffer of the M980 provides a workspace (4Kx8 standard, 16Kx8 optional) where PROM code can be accumulated and manipulated prior to programming a blank PROM. The Buffer can be loaded from the M980 keyboard, Master PROM, or the remote interfaces 9811, 9812, 9814, and 9818. The M980 features Data Displacement during Buffer input and output operations, and enables edit functions to change that data. The M980 power may be switched OFF for at least one week without losing Buffer data. It is recommended that the Buffer be cleared to the erased state of the PROM type used prior to loading valid data into the Buffer. See Fill Buffer Operations in SECTION 7. RESET does not affect the Buffer contents.

The following operations are described in detail to allow the user to perform this transfer of data. These operations may also be used to transfer parts of several different PROMs into the Buffer and to transfer their total sum into one PROM.

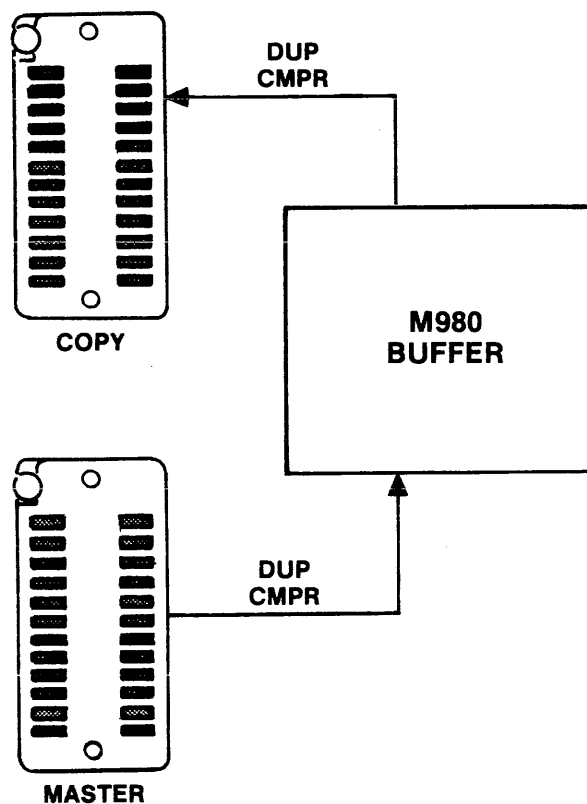

**Duplicating the RAM Buffer from a Master PROM
(example shown is for a 16Kx8 RAM Buffer and a 2Kx8 Master PROM)**

1. Select the switches as shown. Insert the appropriate Personality Module. Insert the PROM into the MASTER socket. The RAM Buffer may be filled with any data prior to this operation by using "Fill Buffer" a Buffer Edit operation described in SECTION 7. The AUDIO switch is optional.



2. Depress RESET. The 8 hex displays are blank.

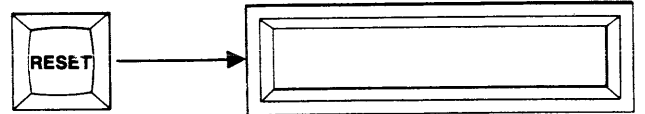

3. Depress DUP. The First and Last Addresses of the Master PROM are displayed.

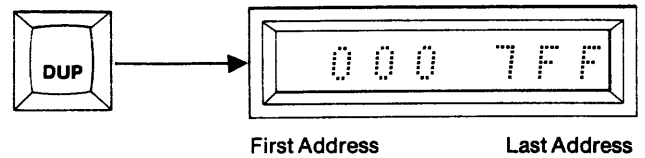

4. To Duplicate the entire contents of the Master PROM into the Buffer go to step 5. To Duplicate over a limited field, use the hex keyboard to key in a new Start and End Address, MSD first.

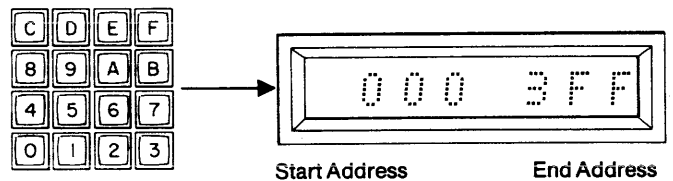

5. Depress ENTER. The M980 accepts the displayed data as the Start and End Addresses for the operation. The display shows "0000", the First Address of the RAM Buffer.

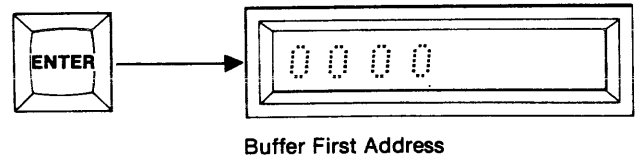

6. If you wish the Duplicate operation to start at the first location of the RAM Buffer, continue to step 7. To redefine the Start Address of the Buffer, use the hex keyboard to key in a new Start Address, MSD first.

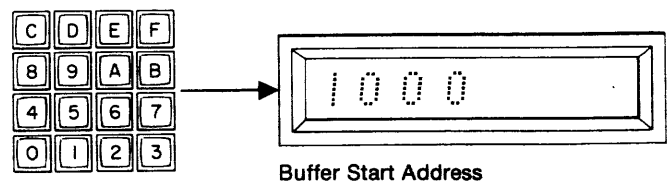

- Depress ENTER. The displayed Start Address for the RAM Buffer is accepted by the M980. "D AAA" is displayed to indicate Duplicate (D) Active. Write Mode LED is lit. The M980 starts duplicating from the Master Start Address into the Start Address of the RAM Buffer. This continues until the end address of the Master is reached. When finished the display shows "D F"

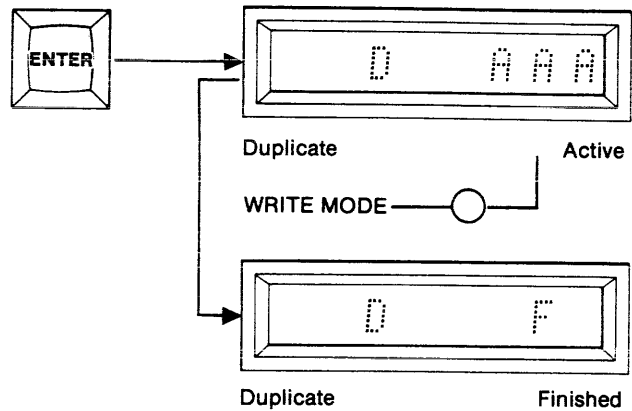

- To repeat the Duplicate operation without resetting, depress ENTER. The hex display shows the previous Start and End Addresses used. You may now redefine the Start and End Addresses as in step 4 or you may depress ENTER again and the previous Buffer Start Address is displayed.

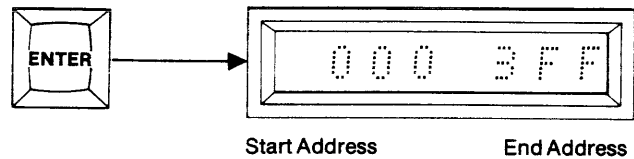

- You may now redefine the Buffer Start Address as in step 6, or you may depress ENTER to start the Duplicate function as in step 7.

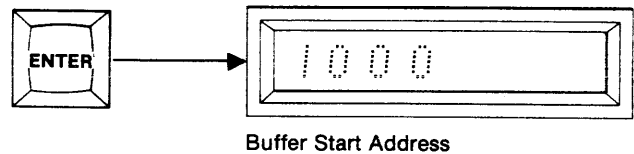

Summary of Duplicating the RAM Buffer from a Master PROM

- Insert Personality Module, Master PROM, and select switches; MFG MODE (OFF), AUDIO (optional ON/OFF), MASTER (ON), BUFFER (ON), COPY (OFF).
- Depress RESET. Displays are blank.
- Depress DUP. First and Last Addresses of Master PROM are displayed.
- Optional. Redefine Start and End Addresses of the Master.
- Depress ENTER. Start Address of RAM Buffer is displayed.
- Optional. Redefine the Buffer Start Address
- Depress ENTER. "D AAA" is displayed for DUP Active. "D F" is displayed when finished.
- Optional. Depress ENTER to repeat Master Start and End Address.
- Optional. Depress ENTER to repeat Buffer Start Address, beginning of Duplicate operation.

Comparing the RAM Buffer with a Master PROM
 (example shown is for a 16Kx8 RAM Buffer and a 2Kx8 Master PROM)

1. Select the switches as shown. Insert the appropriate Personality Module. Insert the Master PROM into the MASTER socket. The AUDIO switch is optional.



2. Depress RESET. The 8 hex displays are blank.

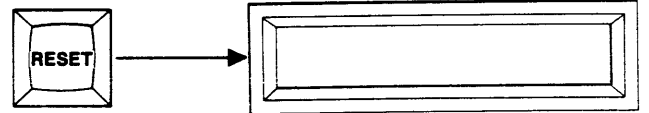

3. Depress CMPR. The 8 hex displays show the First and Last Addresses of the Master PROM.

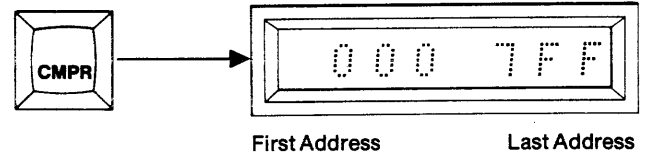

4. If the entire contents of the Master PROM are to be Compared, with the Buffer go to step 5. To Compare a limited field, use the hex keyboard to key in a new Start and End Address, MSD first.

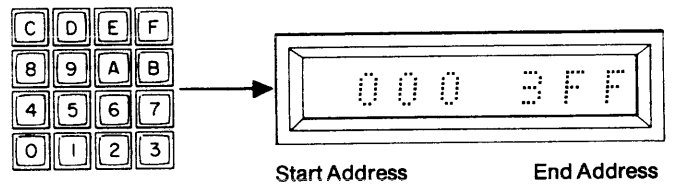

5. Depress ENTER. The M980 accepts the displayed data as the Start and End Addresses for the operation. The display shows "0000" the First Address of the RAM Buffer.

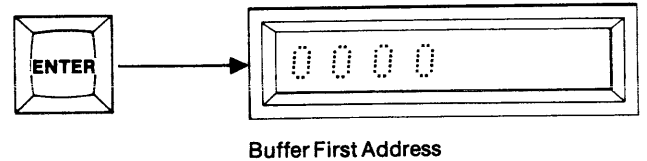

6. If you wish the compare operation to begin at the first location of the RAM Buffer, continue to step 7. To redefine the Start Address of the Buffer, use the hex keyboard to key in a new Start Address, MSD first.

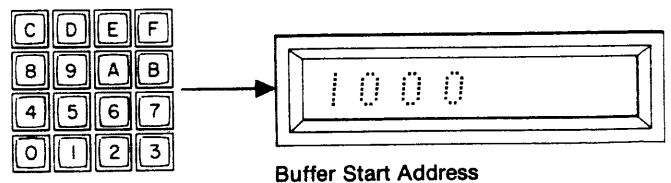

7. Depress ENTER. The displayed Start Address for the RAM Buffer is accepted by the M980. "C AAA" is displayed to indicate Compare (C) Active (AAA). The M980 starts Comparing from the Master PROM Start Address with the Start Address of the RAM Buffer. This continues until the End Address of the Master PROM is reached. When finished the display shows "C F".

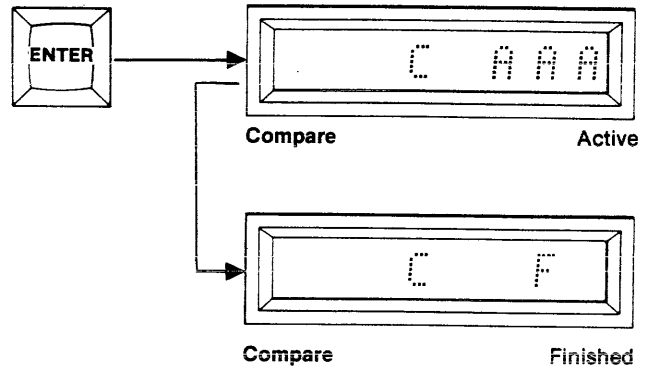

8. If a non-compare occurs, the address and data of the Master location is displayed. By depressing key B, the Buffer address and data may be seen. Depress ENTER to continue, or CLEAR to abort.

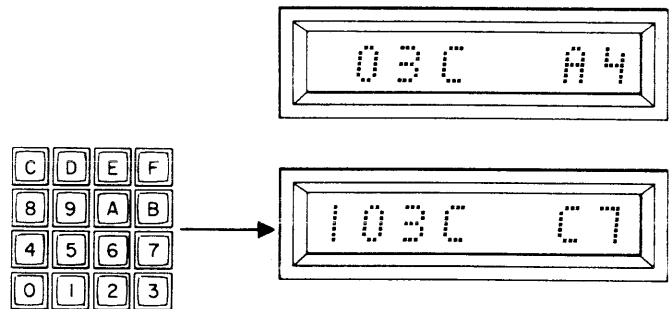

9. To repeat the Compare operation without resetting, depress ENTER. The hex display shows the previous Start and End addresses used. You may now redefine the Start and End Addresses as in step 4 or you may depress ENTER again and the previous Buffer Start Address is displayed. You may redefine the Buffer Start Address as in step 6 and/or go to step 7.

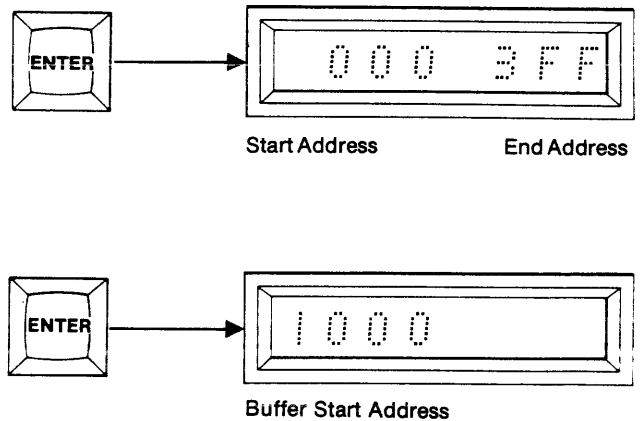

Summary of Comparing the RAM Buffer with a Master PROM

1. Insert Personality Module, Master PROM, and select switches; MFG MODE (OFF), AUDIO (optional ON/OFF), MASTER (ON), BUFFER (ON), COPY (OFF).
2. Depress RESET. Displays are blank.
3. Depress CMPR. First and Last Addresses of Master PROM are displayed.
4. Optional. Redefine Start and End Addresses of the Master PROM.
5. Depress ENTER. Start Address of RAM Buffer is displayed.
6. Optional. Redefine the Buffer Start Address
7. Depress ENTER. "C AAA" is displayed for CMPR Active. "C F" is displayed when finished.
8. Error displayed if non-compare occurs.
9. Optional. Depress ENTER to repeat Compare operation.

Duplicating the RAM Buffer into a Copy PROM
(example shown is for a 16Kx8 RAM Buffer and a 2Kx8 Copy PROM)

1. Select the switches as shown. Insert the appropriate Personality Module. Insert the Copy PROM into the Copy socket. The AUDIO switch is optional.



2. Depress RESET. The 8 hex displays are blank.

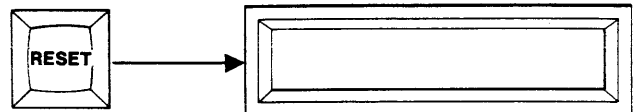

3. Depress DUP. The First and Last Addresses of the Copy PROM are displayed.

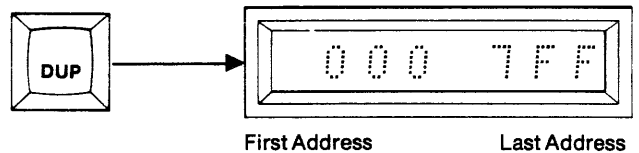

4. To Duplicate the entire contents of the Copy PROM from the Buffer go to step 5. To Duplicate a limited field, use the hex keyboard to key in a new Start and End Address, MSD first.

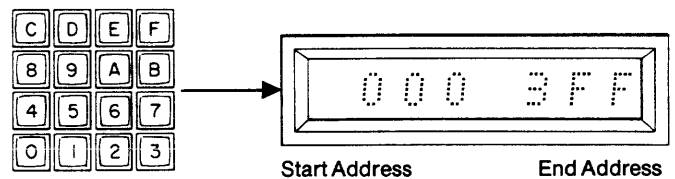

5. Depress ENTER. The M980 accepts the displayed data as the Start and End Addresses for the operation. The display shows "0000" the First Address of the RAM Buffer.

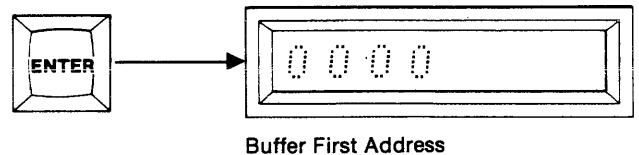

6. If you wish the Duplicate operation to start at the first location of the RAM Buffer, continue to step 7. To redefine the Start Address of the Buffer, use the hex keyboard to key in a new Start Address, MSD first.

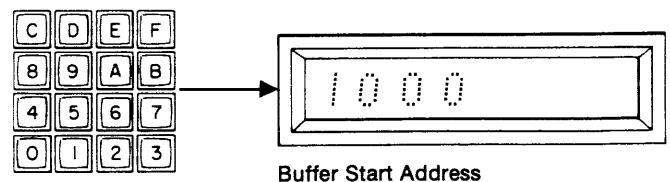

7. Depress ENTER. The displayed Start Address for the RAM Buffer is accepted by the M980. "D AAA" is displayed to indicate Duplicate (D) Active (AAA.) The write mode LED is lit. The M980 starts duplicating to the Copy PROM's Start Address from the Start Address of the RAM Buffer. This continues until the End Address of the Copy PROM is reached. When finished, the display shows "D F."

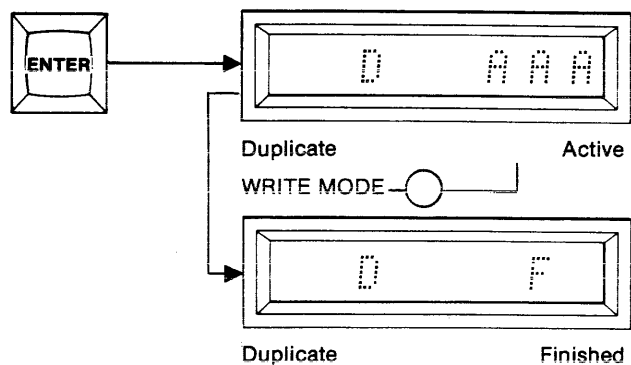

8. To repeat the Duplicate operation without resetting, depress ENTER. The hex display shows the previous Start and End Addresses used. You may now redefine the Start and End Addresses as in step 4 or you may depress ENTER again and the previous Buffer Start Address is displayed. You may redefine the Buffer Start Address as in step 6 and/or go to step 7.

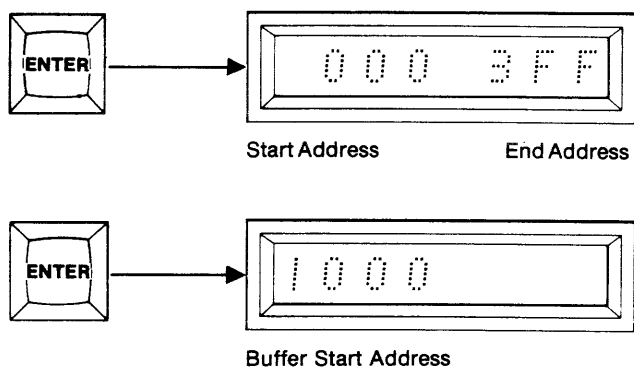

9. If an error should occur, the address and the data of the Buffer where the error occurred are displayed. Depressing key C shows the copy data and address. Depressing key B shows the Buffer data again. See Section 12.

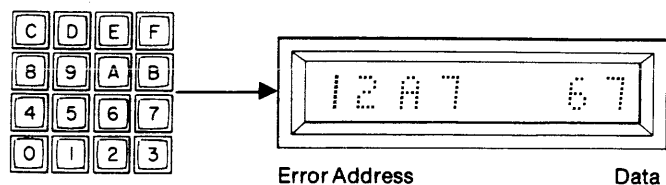

10. Depress ENTER to resume duplication and to return to step 8, or depress CLEAR to abort to Duplicate Finished ("D F"). See Failure to Program operations in SECTION 11.

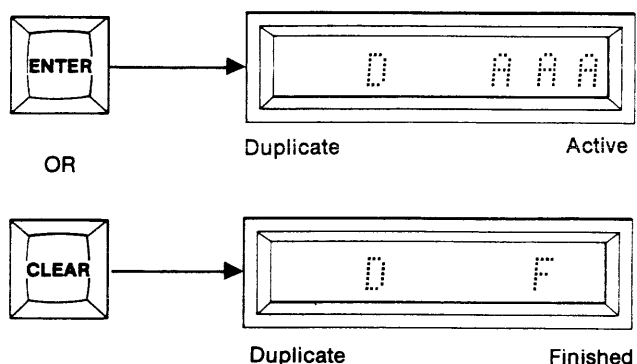

Summary of Duplicating the RAM Buffer into a Copy PROM

1. Insert Personality Module, Copy PROM, and select switches; MFG MODE (OFF), AUDIO (optional ON/OFF), MASTER (OFF), BUFFER (ON), COPY (ON).
2. Depress RESET. Displays are blank.
3. Depress DUP. First and Last Addresses of Copy PROM are displayed.
4. Optional. Key in Start and End Addresses.
5. Depress ENTER. First Address of the Buffer is displayed.
6. Optional. Key in the new Buffer Start Address
7. Depress ENTER. "D AAA" is displayed for Duplicate Active. "D F" is displayed when Finished.
8. Optional. Depress ENTER to repeat the start and End Addresses of the Copy PROM. Depress ENTER again to repeat the Start Address of the Buffer. Return to step 7 to continue the Duplicate operation.
9. If an error occurs, the address and data of the error are displayed. Depress key C to view copy address and data; depress key B to view Buffer address and data.
10. Optional. Depress ENTER to continue with the Duplicate operation or depress CLEAR to abort to Dup Finished.

Comparing the RAM Buffer to a Copy PROM
 (example shown is for a 16Kx8 RAM Buffer and a 2Kx8 Copy PROM)

1. Select the switches as shown. Insert the appropriate Personality Module. Insert the Copy PROM in the COPY socket. The AUDIO switch is optional.



2. Depress RESET. The 8 hex displays are blank.

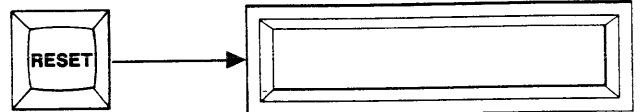

3. Depress CMPR. The 8 hex displays show the First and Last Address of the Copy PROM.

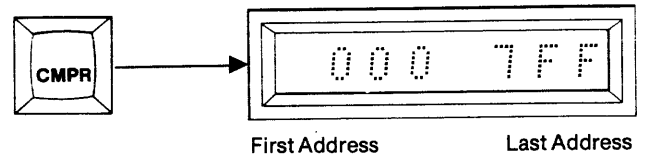

4. To Compare the entire contents of the Copy PROM with the Buffer, go to step 5. To Compare a limited field, use the hex keyboard to key in a new Start and End Address, MSD first.

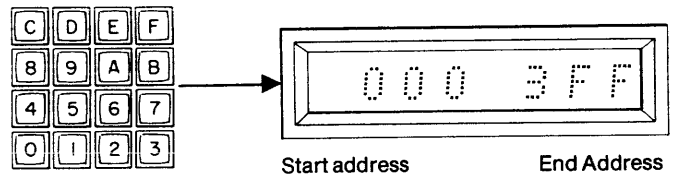

5. Depress ENTER. The M980 accepts the displayed data as the Start and End Addresses for the operation. The display shows "0000" the First Address of the RAM Buffer.

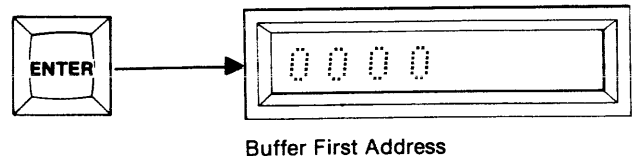

6. If you wish the Compare operation to start with the first location of the RAM Buffer, continue to step 7. To redefine the Start Address of the Buffer, use the hex keyboard to key in a new Start Address, MSD first.

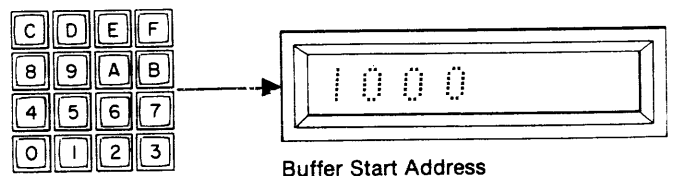

7. Depress ENTER. The displayed Start Address for the RAM Buffer is accepted by the M980. "C AAA" is displayed to indicate Compare (C) Active (AAA). The M980 begins comparing the Start Address of the Buffer with the Start Address of the Copy PROM. This continues until the End Address of the Copy PROM is reached. When finished the display shows "C F".

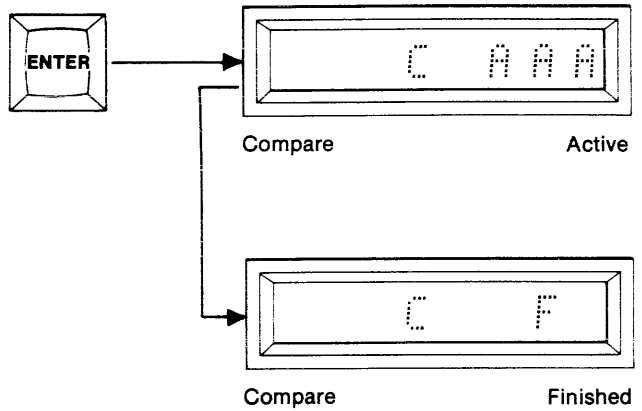

8. To repeat the Compare operation without resetting, depress ENTER. The hex display shows the previous Start and End Addresses used. You may now redefine the Start and End Addresses as in step 4 OR you may depress ENTER again and the previous Buffer Start Address is displayed. You may redefine the Buffer Start Address as in step 6 and/or go to step 7.

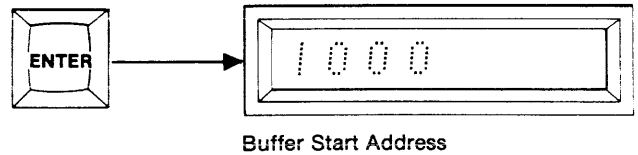
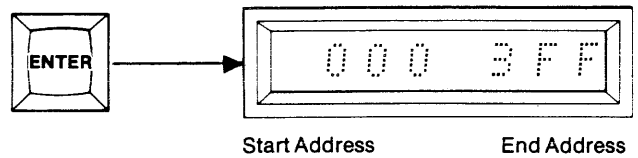

9. If an error should occur, the address and the data of the Buffer where the error occurred are displayed. Depressing key C shows the copy data and address. Depressing key B shows the Buffer data and address again. See Section 12.

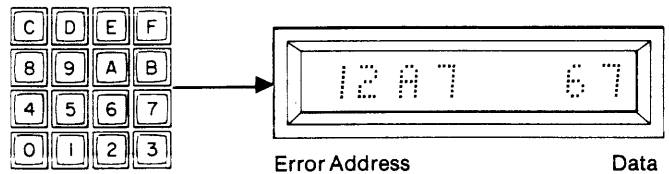

10. Depress ENTER to resume Compare operations and to return to step 8 OR depress CLEAR to abort to Compare Finished. See Failure to Program Operations in SECTION 11.

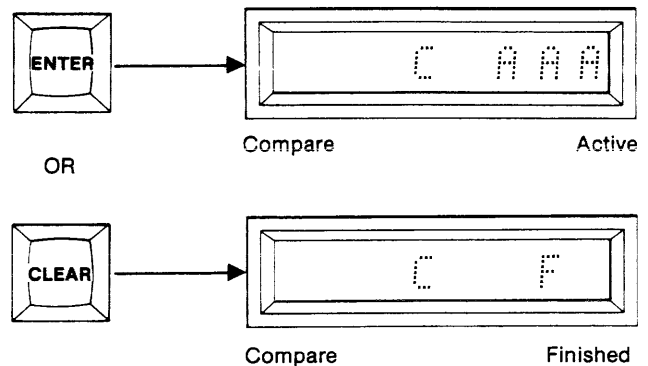

Summary of Comparing the RAM Buffer with a Copy PROM

1. Insert Personality Module, Copy PROM, and select switches; MFG MODE (OFF), AUDIO (optional ON/OFF), MASTER (OFF), BUFFER (ON), COPY (ON).
2. Depress RESET. All displays are blank.
3. Depress CMPR. First and Last Addresses of the Copy PROM are displayed.
4. Optional. Key in the new Start and End Addresses.
5. Depress ENTER. The First Address of the Buffer is displayed.
6. Optional. Key in the new Buffer Start Address.
7. Depress ENTER. "C AAA" is displayed for Compare Active. "C F" is displayed when finished.
8. Optional. Depress ENTER to repeat the Start and End Addresses of the Copy PROM. Depress ENTER again to repeat the Start Address of the Buffer. Go to step 7 to continue the Compare operation.
9. If an error occurs, the address and data of the error are displayed. Depress key C to view copy data and key B to view Buffer data.
10. Optional. Depress ENTER to continue with the Compare operation or depress CLEAR to abort to Compare Finished.

Performing an Illegal Bit Check on a Copy PROM from the Buffer (example shown is for a 16Kx8 RAM Buffer and a 2Kx8 Copy PROM)

The Illegal Bit Check operation checks for the possibility of overwriting the PROM in the copy socket over the defined field with data from the buffer. Illegal Bit Check determines the erased state of the PROM under consideration from the lookup table in the personality module. If the copy PROM has a nonerased location that has an erased state to be written, an error condition will occur. No attempt will be made to actually write data to the copy PROM during illegal bit check.

1. Select switches as shown.



2. Depress RESET. The 8 hex displays are blank.

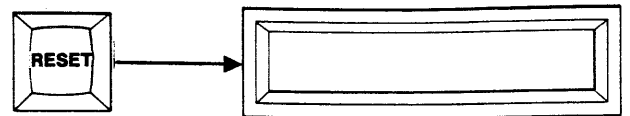

3. Press BLNK CHCK. The first and last addresses of the Copy PROM will be displayed.

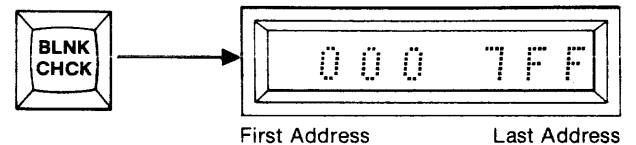

4. To perform Illegal Bit Check over displayed field, go to step 5. To change address field, use keyboard to enter new Start and End Address. See SECTION 3 for more details. Use CLEAR key for corrections. When the complete field is defined, go on to the next step.

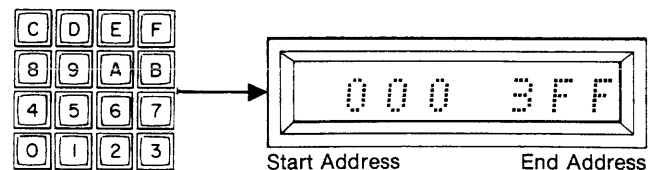

5. Depress ENTER. The M980 will accept the Start/End Address displayed as the field over which the IBC will be performed. The display shows "0000", the first address of the RAM Buffer.

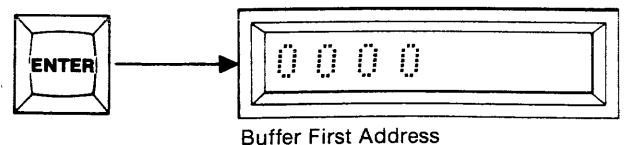

6. If you wish the IBC to begin at the Buffer location shown, go to step 7. To redefine the Start Address of the Buffer, use hex keyboard to key in new Buffer Start Address, MSD first. Use CLEAR key if corrections are needed.

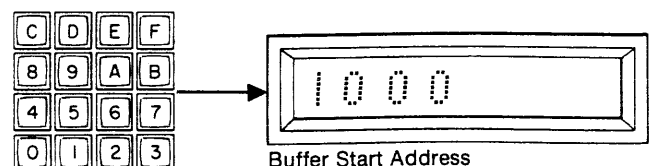

7. Depress ENTER. The displayed Start Address for the RAM Buffer is accepted. "B AAA" is displayed to show that the IBC is being performed over the addresses accepted. The M980 performs the IBC between the Start Address of the copy PROM and the Start Address of the Buffer in sequential order. When finished, the display shows "B F."

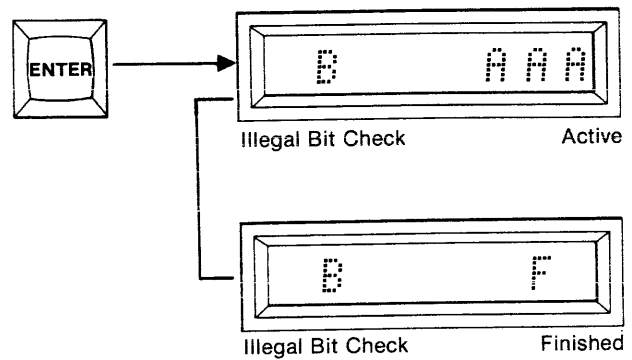

8. If the Illegal Bit Check finds a location that can't be overwritten, the address and data of the Buffer at that location is shown. Depressing key "C" shows the corresponding location of the Copy PROM address and data. Depressing key "B" will restore Buffer address and data to the display.

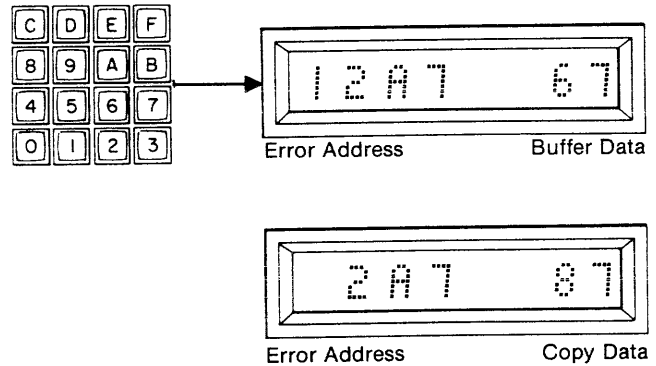

9. Depress ENTER to continue IBC, or CLEAR to force finish ("B F"), then depress ENTER to return to step 4.

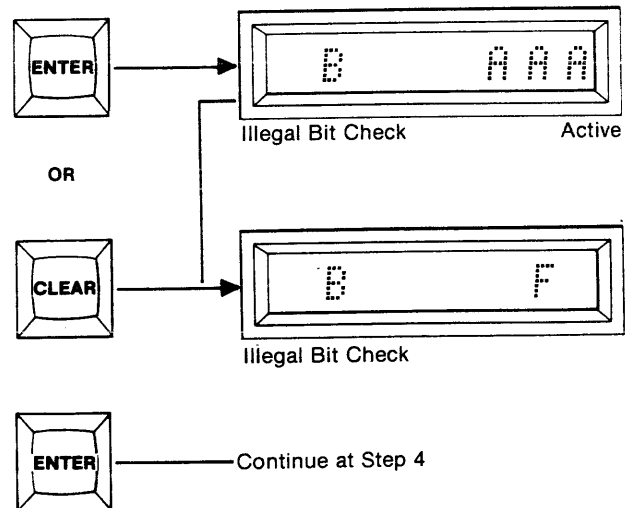

Summary of illegal Bit Checking the RAM Buffer to a Copy PROM

1. Insert Personality Module, Copy PROM, and select switches; MFG MODE (OFF), AUDIO (optional ON/OFF), MASTER (OFF), BUFFER (ON) COPY (ON).
2. Depress RESET. All displays are blank.
3. Depress BLNK CHCK. First and Last Addresses of the Copy PROM are displayed.
4. Optional. Key in the new Start and End Addresses.
5. Depress ENTER. The First Address of the Buffer is displayed.
6. Optional. Key in the new Buffer Start Address.
7. Depress ENTER. "B AAA" is displayed for IBC Active. "B F" is displayed when finished.
8. Optional. Depress ENTER to repeat the Start and End Addresses of the Copy PROM. Depress ENTER again to repeat the Start Address of the Buffer. Go to step 7 to continue the IBC operation.
9. If an illegal condition occurs, the address and data of the error are displayed. Depress Key C to view copy data and Key B to view Buffer data.
10. Optional. Depress ENTER to continue with the IBC operation or depress CLEAR to abort to IBC Finished.

ADDITIONAL BUFFER OPERATIONS

The CMOS RAM Buffer of the M980 provides a workspace (4Kx8 standard, 8Kx8 and 16Kx8 optional) where PROM code can be accumulated and manipulated prior to programming a blank PROM. The Buffer can be loaded from the M980 keyboard, Master PROM, or the remote interfaces 9811, 9812, 9814, and 9818. The M980 features Data Displacement during Buffer input and output operations, and enables edit functions to change that data. The M980 power may be switched OFF for at least one week without losing Buffer data. It is recommended that the Buffer be cleared to the erased state of the PROM type used prior to loading valid data into the Buffer. See Fill Buffer Operations in SECTION 7. RESET does not affect the Buffer contents.

The M980 Buffer Edit operations are selected via the hex keyboard after RESET and the EDIT key are depressed. In its present configuration the M980 RAM Buffer is seen as an 8-bit Buffer when performing Invert, Insert, Delete, and Fill Buffer operations. The Nibble Swap, Hex Pack, and Hex Unpack operations are provided for 4-bit manipulation.

Only the Buffer is involved in the following operations; it is not mandatory that a Personality Module be installed, a warning "E4" is displayed; this can be overridden by continuing with the operation.

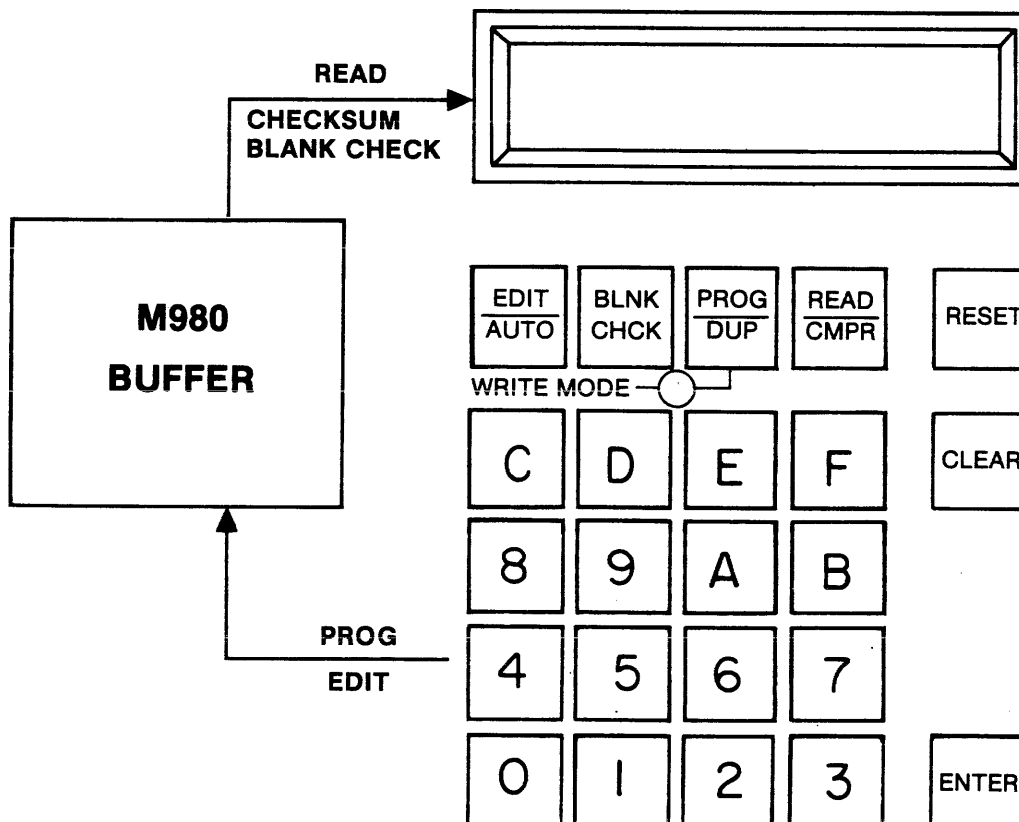

Figure 7-1

Programming the RAM Buffer using the M980 Keyboard (example shown is for 8Kx8 RAM Buffer)

1. Select the switches as shown. The AUDIO switch is optional.



2. Depress RESET. The 8 hex displays are blank. A Personality Module is not necessary. "E4" is displayed if a Personality Module is not present. A warbling tone will sound if the AUDIO switch is ON. You may now continue.

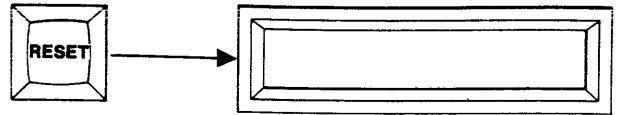

3. Depress PROG. The 8 hex displays should show the First and Last Addresses of the RAM Buffer.

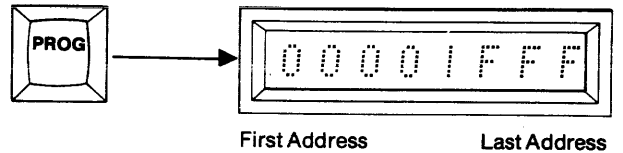

4. To Program the entire contents of the RAM Buffer, starting with the First Address, go to step 5. To Program a limited field, use the hex keyboard to key in a new Start and End Address, MSD first.

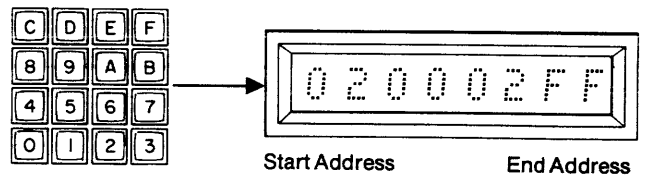

5. Depress ENTER. The M980 accepts the displayed data as the Start and End Addresses for the operation. The display shows the Start Address in the left-most display. The Write Mode LED is lit.

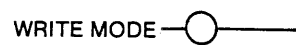
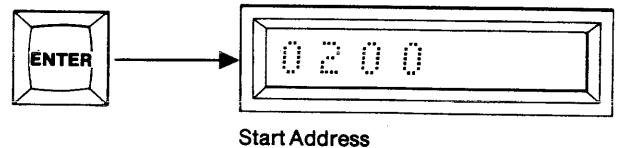

6. To Program the address displayed, key in the desired data, MSD first, using the CLEAR key to correct mistakes. To step over a location, continue to step 7.

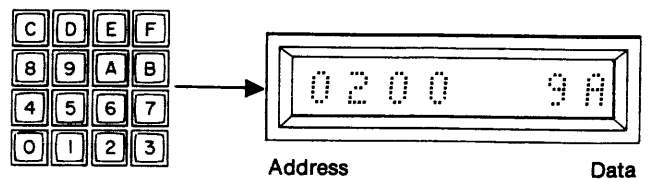

- Depress ENTER to initiate Programming of the displayed data, or to step over an address without altering it. The next sequential address is displayed. Repeat steps 6 and/or 7 for each address.

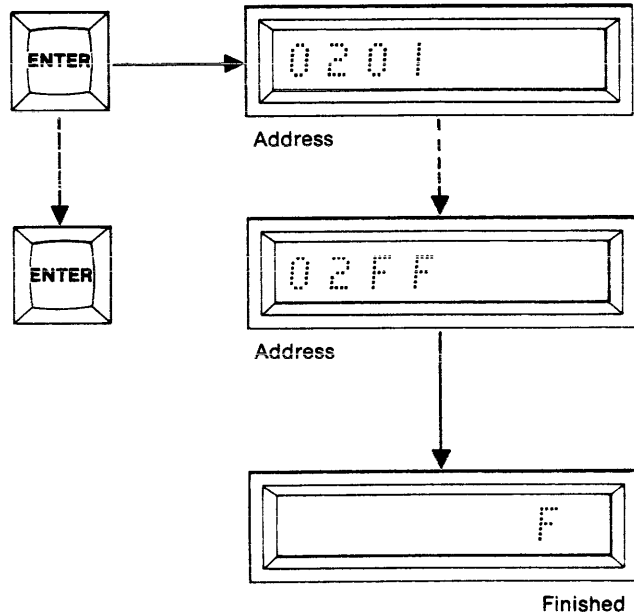

- When the End Address is displayed and steps 6 and/or 7 are initiated, an "F" appears to indicate that the Program mode has been performed over the specified Address field.

- To repeat the Program operation without resetting, depress ENTER when "F" is displayed. This displays the Start and End Address field previously used. You are now back at step 4. The Start and End Address field can be redefined or you can continue with the displayed Start and End Addresses.



Summary of Programming the RAM Buffer using the M980 Keyboard

- Set select switches: MFG MODE (OFF), AUDIO (optional ON/OFF), MASTER (OFF), BUFFER (ON), COPY (OFF).
- Depress RESET. All displays are blank.
- Depress PROG. First and Last Addresses are displayed.
- Optional. Redefine the the Start and End Addresses via the hex keyboard.
- Depress ENTER. The address shown is accepted and the Start Address is displayed.
- Optional. Key in the data to be programmed.
- Depress ENTER. This programs the previously keyed data or step over the displayed address. Repeat for every address.
- The End Address is reached and "F" is displayed to indicate Finished.
- Depress ENTER to return to step 4 if desired.

Reading the RAM Buffer using the M980 Keyboard (example shown is for an 8Kx8 RAM Buffer)

1. Select the switches as shown. The AUDIO switch is optional.



2. Depress RESET. The 8 hex displays are blank. A Personality Module is not necessary. "E4" is displayed if a Personality Module is not present. A warbling tone will sound if the AUDIO switch is ON. You may now continue.

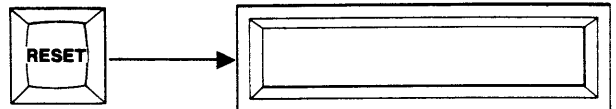

3. Depress READ. The 8 hex displays show the First and Last Addresses of the RAM Buffer.

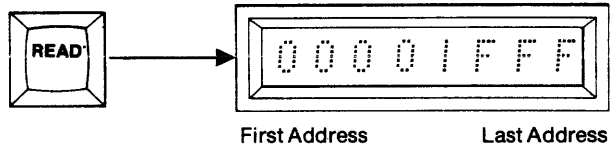

4. To Read the entire contents of the RAM Buffer, starting with the First Address, go to step 5. To Read a limited field, use the hex keyboard to key in a new Start and End Address, MSD first.

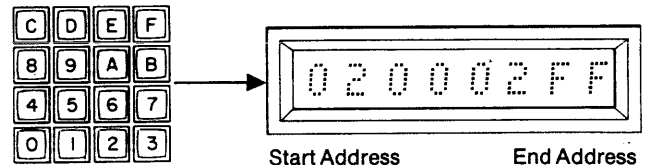

5. Depress ENTER. The M980 accepts the displayed data as the Start and End Addresses for the operation. The display shows the Start Address in the left-most display. The data located at that address is displayed in the right-most display. Repeat step 5 and the next sequential address and data are displayed. Repeat until the End Address is reached, RESET occurs, OR

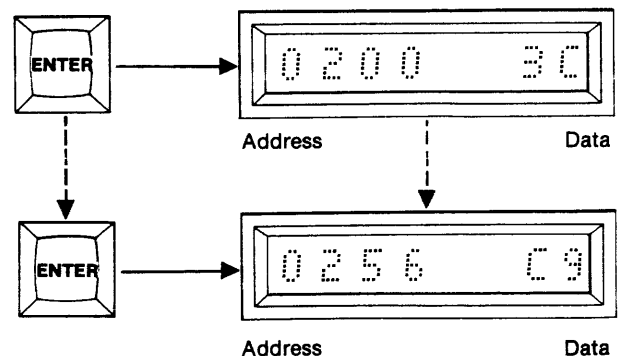

6. By Depressing CLEAR during the Read operation the addresses are decremented and the data at that address is displayed. The M980 can decrement past the defined Start Address. Wrap-around occurs if an all-zero address is reached and decremented again.

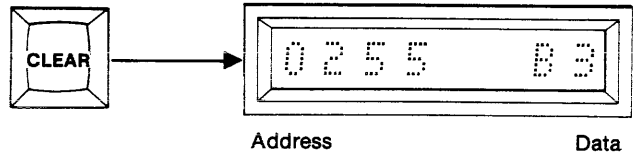

7. When the End Address is reached, its data displayed, and ENTER is depressed, an "F" is displayed to indicate Finished.

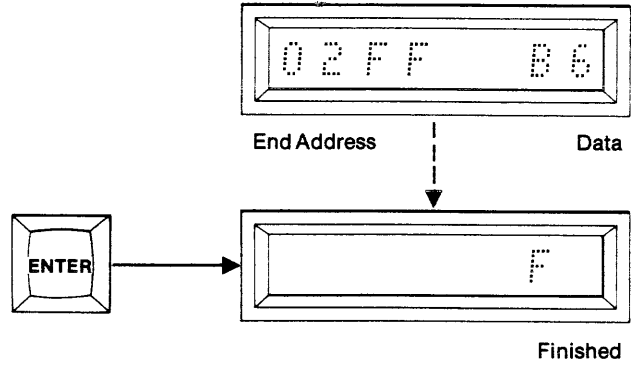

8. To repeat the Read mode without resetting, depress ENTER when the "F" appears. The previous Start and End Addresses are displayed. Continue with step 4 and/or 5.

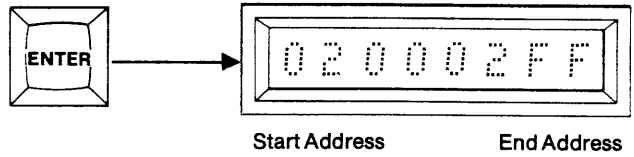

Summary of Reading the RAM Buffer using the M980 Keyboard

1. Set select switches: MFG MODE (OFF), AUDIO (optional ON/OFF), MASTER (OFF), BUFFER (ON), COPY (OFF).
2. Depress RESET. Displays are blank.
3. Depress READ. First and Last Addresses are displayed.
4. Optional. Redefine the Start and End Addresses.
5. Depress ENTER. The Start Address and its corresponding data are displayed. Repeat for each sequential address OR
6. Optional. Depress CLEAR to decrement the address and display its data.
7. End Address is reached and ENTER is depressed. An "F" is displayed to indicate Finished.
8. Optional. Depress ENTER to show the previous Start and End Addresses and return to step 4 and/or 5.

**Performing a Read/Modify on the RAM Buffer
(example shown is for an 8Kx8 RAM Buffer)**

1. Repeat steps 1 through 5 of the Read Buffer operation (page 7-5) until the desired address is reached.

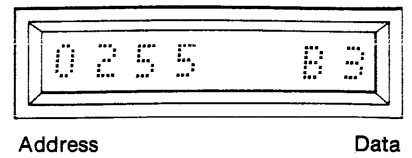

2. The display now shows the address and data of the location to be modified. Enter new data by using the hex keyboard, MSD first, until the data displays are filled with the desired data. As soon as a hex key is depressed, the Write Mode LED is lit.

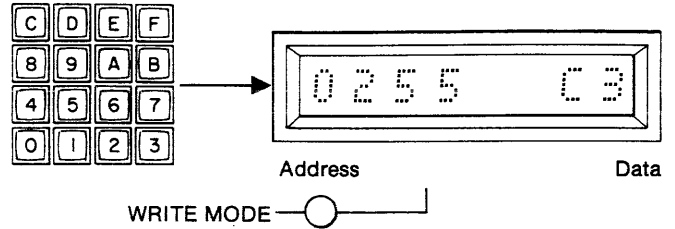

3. Depress ENTER. The data displayed is written into the RAM Buffer at the displayed address. The next sequential address and data are displayed. The Write Mode LED is extinguished. Continue until the End Address is reached.

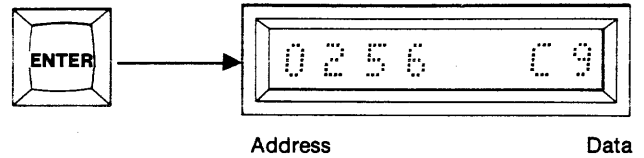

Performing a Checksum on the M980 RAM Buffer (example shown is for an 8Kx8 RAM Buffer)

1. Select the switches as shown. The AUDIO switch is optional.



2. Depress RESET. The 8 hex displays are blank. A Personality Module is not necessary. "E4" is displayed if a Personality Module is not present. A warbling tone will sound if the AUDIO switch is ON. You may now continue.

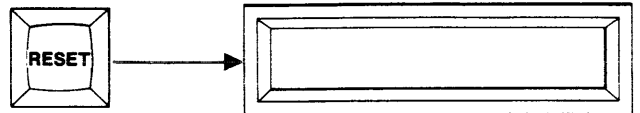

3. Depress key C. The First and Last Addresses of the RAM Buffer are displayed.

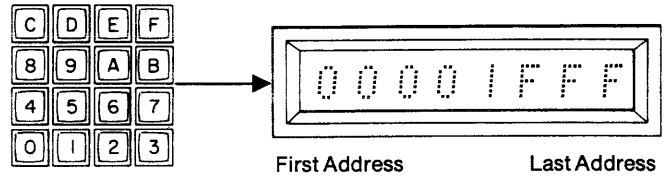

4. To Checksum the entire contents of the RAM Buffer, starting with the First Address, go to step 5. To Checksum a limited field, use the hex keyboard to key in a new Start and End Address, MSD first.

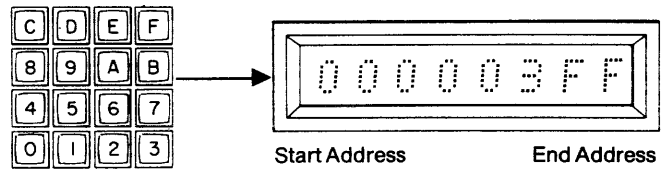

5. Depress ENTER. The M980 accepts the displayed data as the Start and End Addresses for the operation. The display shows "CC AAA" to indicate Checksum (CC) Active (AAA). When the Checksum is complete, the six digit hex equivalent is displayed.

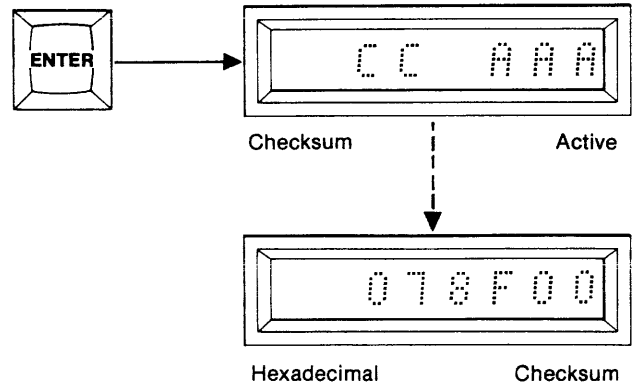

Summary of Performing a Checksum on the RAM Buffer

1. Set select switches; MFG MODE (OFF), AUDIO (optional ON/OFF), MASTER (OFF), BUFFER (ON), COPY (OFF)
2. Depress RESET. All displays are blank.
3. Depress key C. First and Last Addresses are displayed.
4. Optional. Redefine the Start and End Addresses.
5. Depress ENTER. "CC AAA" is displayed while active. Hexadecimal Checksum is displayed when finished.

BUFFER EDIT FUNCTIONS

Buffer Edit functions are provided for manipulating Buffer data into a more useful form. Currently, there are nine Buffer Edit modes, summarized below. The word length of the Buffer is always 8 bits in the Edit mode.

HEX KEY CODE	EDIT MODE	DESCRIPTION
00	SET WORD SIZE	Set Buffer word size to 4, 8, 12 or 16 bits.
01	INVERT	Complement a data field.
02	FILL BUFFER	Load Buffer field with a specific data byte.
03	INSERT	Insert a block of data into a specified address field.
04	DELETE	Delete a block of data and close within a specified address field.
05	BLOCK MOVE	Move a block of data from one address field to another address field.
06	NIBBLE SWAP	Exchange upper and lower hex digits within an address field.
07	HEX PACK	Combine unpacked digits from two defined address fields.
08	HEX UNPACK	Separate packed digits to form two unpacked address fields.

Buffer Edit — Set Word Size

The Set Word Size mode configures the Buffer word length for 4, 8, 12 or 16 bits. When the RESET key is depressed, the Buffer word length defaults to the Personality Module word size. If no Personality Module is installed, then the defaulted word size is 8 bit. Programming and Reading of the Buffer is dependent on the word size setting.

Example: Read the Buffer with 4 bit word lengths.

- Select the switches as shown. The AUDIO switch is optional.



- Depress RESET. The 8 hex displays are blank.

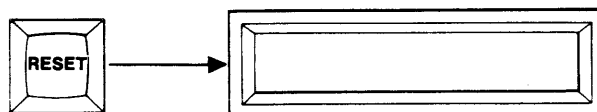

- Depress EDIT. "E 00" is displayed to indicate Edit mode 00.

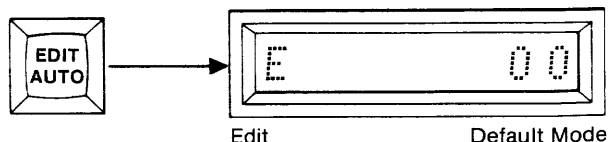

4. Depress ENTER. The display shows "E 00" to indicate Edit Set Word Size.

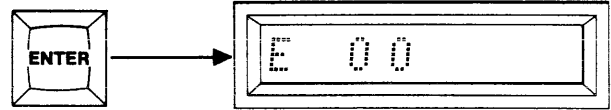

5. Use the hex keyboard to key in the desired word size 4, 8, 12 or 16 bit.

- Hex key 1 04
- Hex key 2 08
- Hex key 3 12
- Hex key 4 16

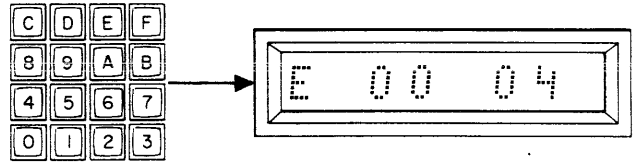

3. Depress the ENTER key. The previous selected word size is now accepted. A steady tone sounds if the AUDIO switch is ON. The "F" indicates finished.

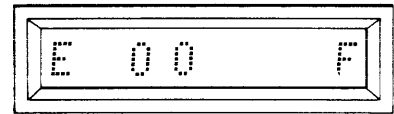

Buffer Edit - Invert (Complement)
(example shown is for a 4K block of data in an 8Kx8 RAM Buffer)

1. Select the switches as shown. The AUDIO switch is optional.

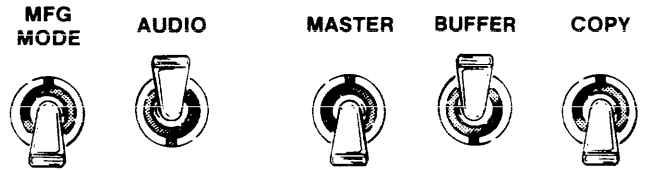

2. Depress RESET. The 8 hex displays are blank. A Personality Module is not necessary. "E4" is displayed if a Personality Module is not present. A warbling tone will sound if the AUDIO switch is ON. You may now continue.

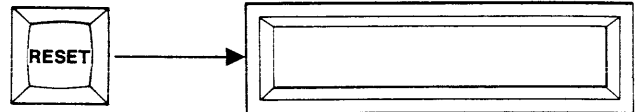

3. Depress EDIT. "E 00" is displayed to indicate Edit mode 00.

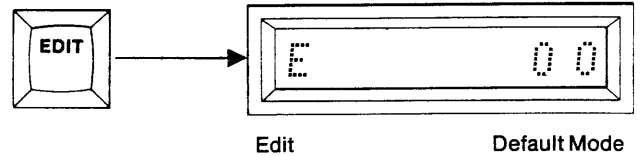

4. Using the hex keyboard, key in "01" to select Invert mode.

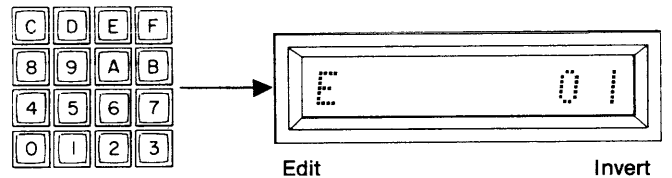

5. Depress ENTER. Invert Mode is accepted and the First and Last Addresses of the Buffer are displayed.

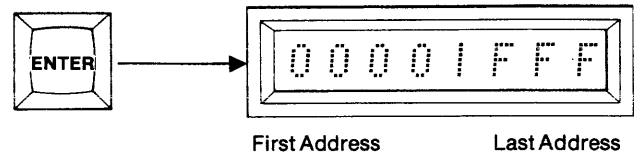

6. To perform the Invert operation over the entire contents of the Buffer, starting with the First Address, go to step 7. To Invert a limited field, use the hex keyboard to key in a new Start and End Address field, MSD first.

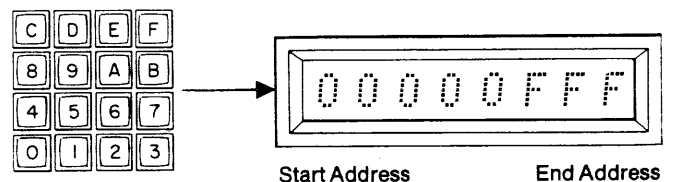

7. Depress ENTER. The displayed address is accepted as the Start and End Addresses for the operation. "E01 AAA" is displayed to indicate Edit Invert Active. The Write Mode LED is lit. Upon Completion of the operation, "E01 F" is displayed to indicate Finished. A steady tone sounds if the AUDIO switch is ON. The Write Mode LED is extinguished.

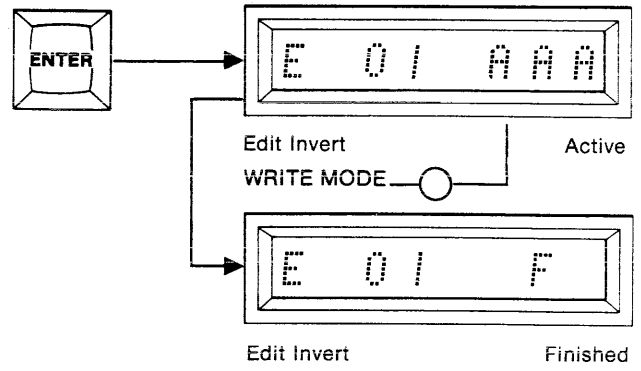

Buffer Edit — Fill Buffer
 (example shown is for a 2K block of data in an 8Kx8 RAM Buffer)

1. Select the switches as shown. The AUDIO switch is optional.

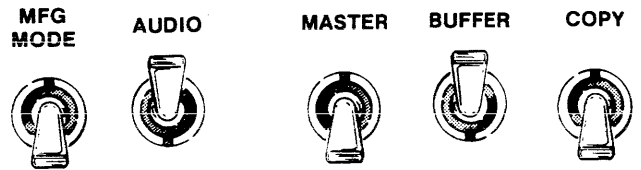

2. Depress RESET. The 8 hex displays are blank. A Personality Module is not necessary. "E4" is displayed if a Personality Module is not present. A warbling tone will sound if the AUDIO switch is ON. You may now continue.

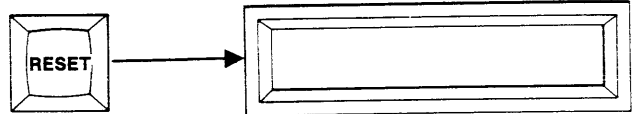

3. Depress EDIT. "E 00" is displayed to indicate Edit mode 00.

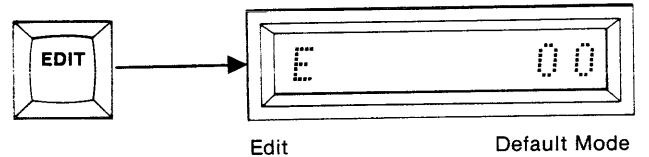

4. Using the hex keyboard, key in "02" to select Fill Buffer Mode.

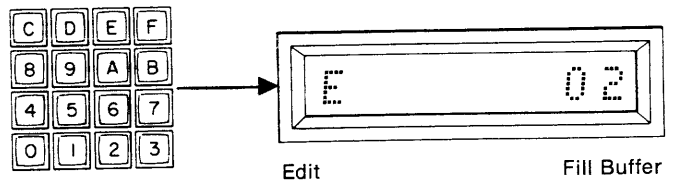

5. Depress ENTER. The Fill Buffer Mode is accepted and the First and Last Addresses of the Buffer are displayed.

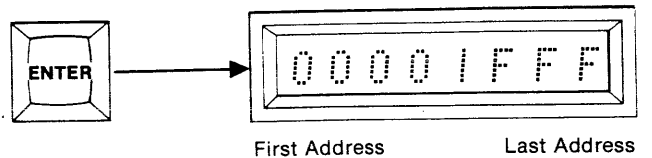

6. To perform the Fill Buffer operation over the entire contents of the Buffer, go to step 7. To operate over a limited field, use the hex keyboard to key in a new Start and End Address field, MSD first.

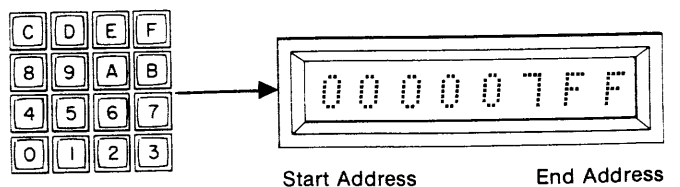

7. Depress ENTER. The display shows "E02 FF" to indicate the Edit Fill Buffer Mode and the data to be loaded into the Buffer as default data.

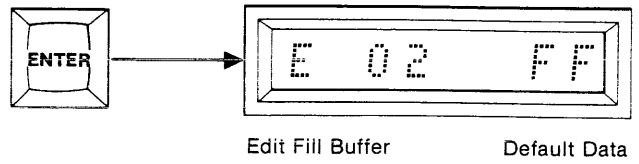

8. Use the hex keyboard to key in new data or default to FF.

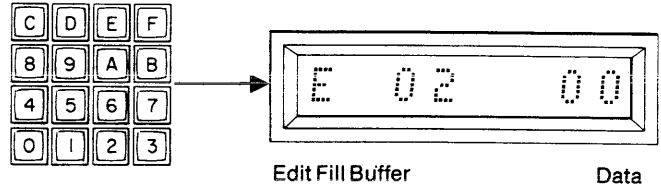

9. Depress ENTER. The data is accepted and replaced with "AAA" to indicate Edit Fill Buffer Active. The Write Mode LED is lit. Upon completion of the operation, the "AAA" is replaced with "F" to indicate Finished. A steady tone sounds if the AUDIO switch is ON. The Write Mode LED is extinguished.

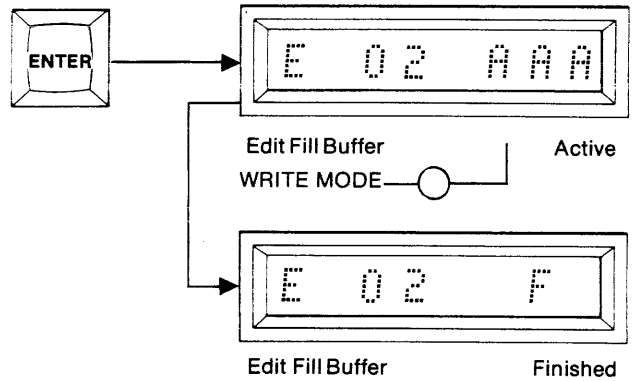

Buffer Edit — Insert
(example shown is for an 8Kx8 RAM Buffer)

In the Insert Mode of operation up to 32 eight bit data bytes may be inserted. The operation can be defined to operate over any defined Buffer address field. The Start Address should always be the first location at which an insertion is made. If a Buffer address field is not given the entire Buffer address. All insertions must be sequential, starting with the First Address of the defined Buffer address. (See Figure 7-2.) The example shown is over the defined Buffer address field of 1000 to 10FF. Figure 7-2 shows the insertion of three data bytes at locations 1000, 1001, and 1002. In this case locations 10FD, 10FE, and 10FF are lost from the end of the Buffer address field.

1. Select the switches as shown. The AUDIO switch is optional.



2. Depress RESET. The 8 hex displays are blank. A Personality Module is not necessary. "E4" is displayed if a Personality Module is not present. A warbling tone will sound if the AUDIO switch is ON. You may now continue.

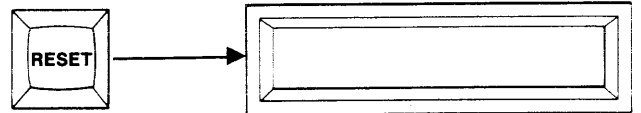

3. Depress EDIT. "E 00" is displayed to indicate Edit Mode 00.

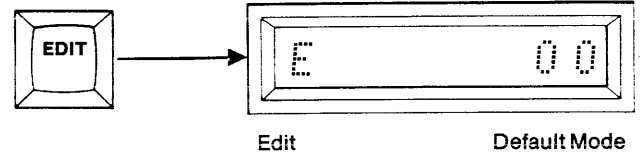

4. Using the hex keyboard, key in "03" to select the Insert Mode.

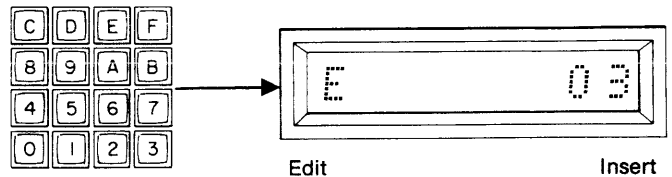

5. Depress ENTER. Insert is accepted and the First And Last Addresses of the Buffer are displayed.

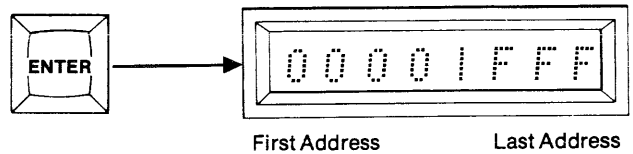

6. Use the hex keyboard to key in a new Start and End Address field, MSD first. It is not possible to insert over the full address range of the Buffer without creating wraparound. If this is tried, the M980 will display an "E3" during step 9.

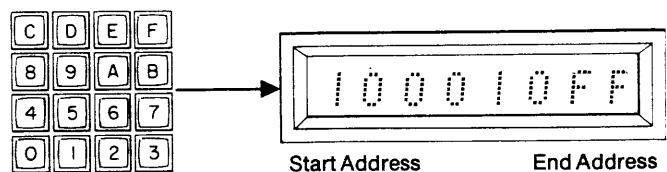

7. Depress ENTER. The Start and End Addresses are accepted. The display shows the block Start Address.

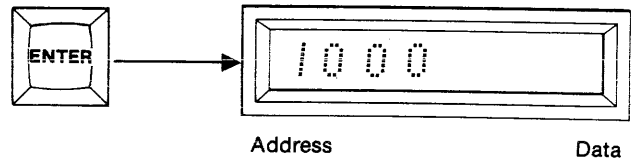

8. Use the keyboard to key in the new data to be inserted.

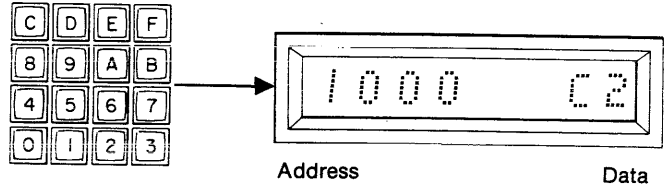

9. Depress ENTER. The address and data are accepted. The next sequential address is displayed. If more insertions are desired, repeat steps 8 and 9 for up to 32 insertions OR

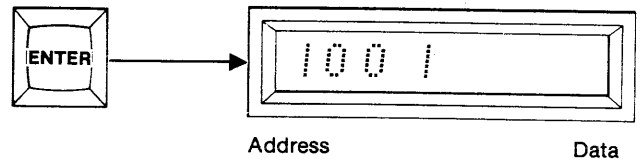

10. Depress ENTER. The display shows "E03 AAA" to indicate Edit Insert Active. The write Mode LED is lit. Upon completion of the operation the "AAA" is replaced with "F" to indicate Finished. A steady tone sounds if the AUDIO switch is ON. The Write Mode LED is extinguished.

NOTE: Depending on size of block to be inserted, the operation may require as much as 60 seconds to perform.

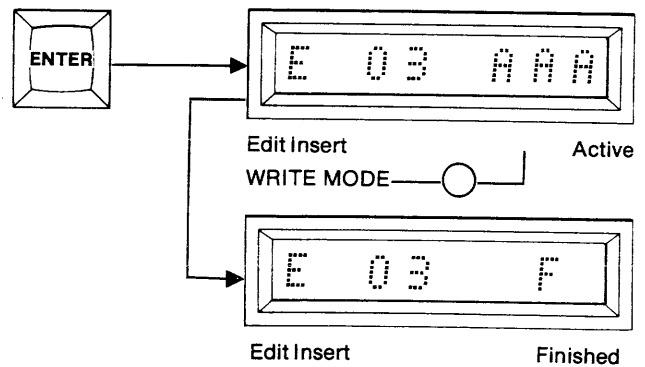

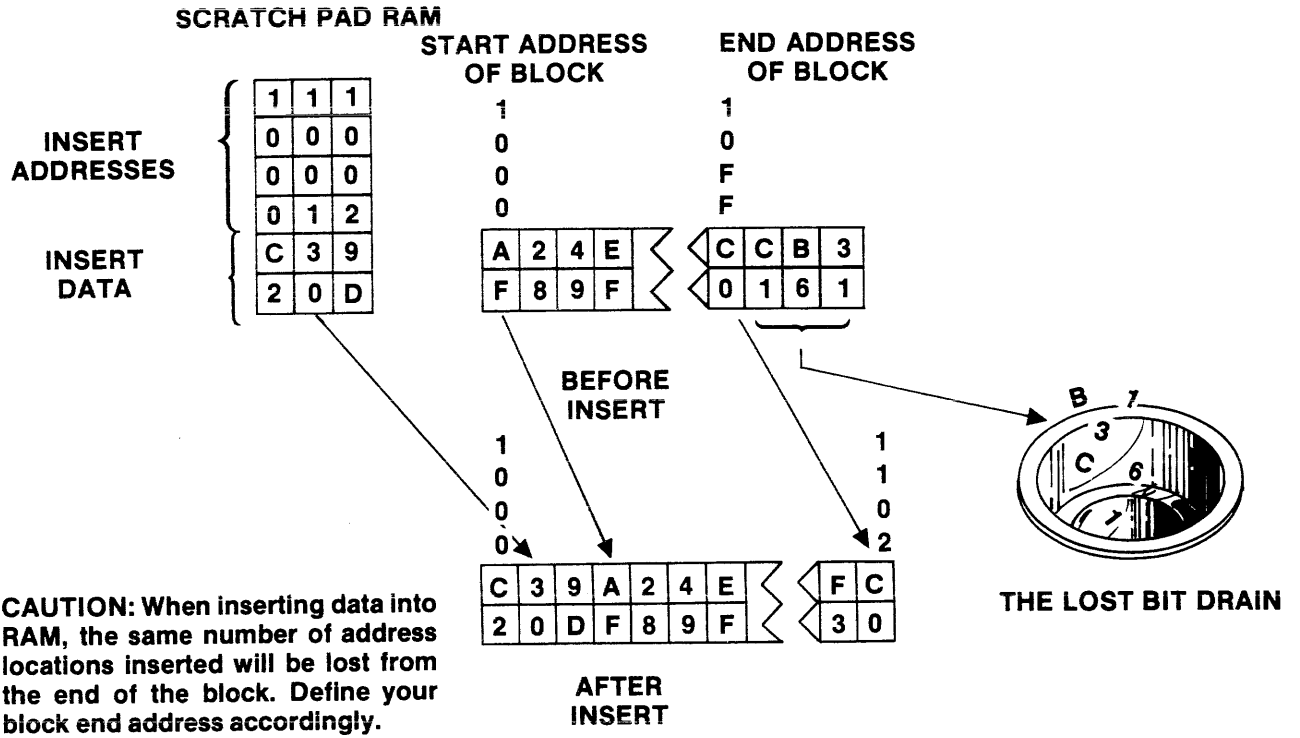

Figure 7-2 — Illustration of Edit Insert

Buffer Edit — Delete (example shown is for an 8kx8 RAM Buffer)

When deleting information, the data locations vacated when all data is moved up, are filled with a user-defined value. The example shown is for deleting locations 1000 through 10FF and operating over a block of 256 locations (1000-10FF). The data used to fill in the vacated locations is 00 (See Figure 7-3).

1. Select the switches as shown. The AUDIO switch is optional.



2. Depress RESET. The 8 hex displays are blank. A Personality Module is not necessary. "E4" is displayed if a Personality Module is not present. A warbling tone will sound if the AUDIO switch is ON. You may now continue.

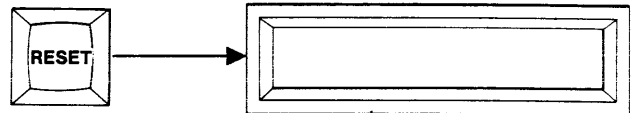

3. Depress EDIT. "E 00" is displayed to indicate Edit Mode 00.

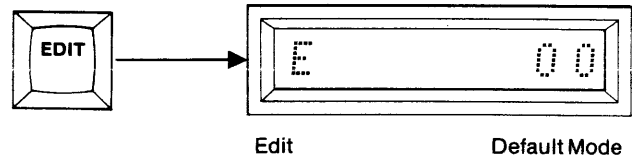

4. Using the hex keyboard, key in "04" to select the Delete operation.

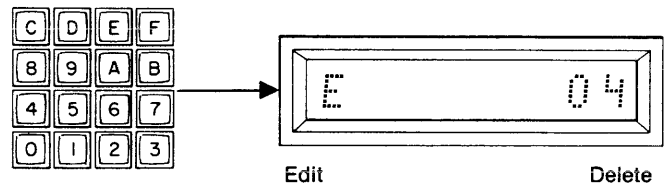

5. Depress ENTER. The Delete Mode is accepted and the First and Last Addresses of the Buffer are displayed.

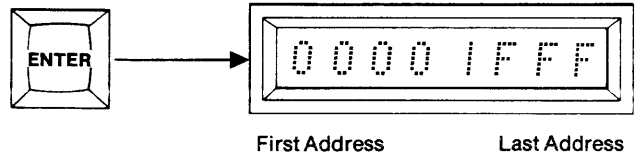

6. Using the hex keyboard, key in the Start and End Address limits of the data block to be deleted or default to the entire Buffer. The Start Address should be the First Address at which data is to be deleted.

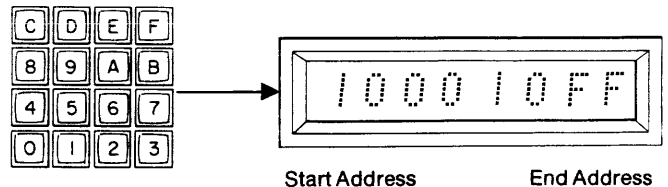

7. Depress ENTER. The Start and End Addresses of the block are accepted and the Start Address of the block is displayed.

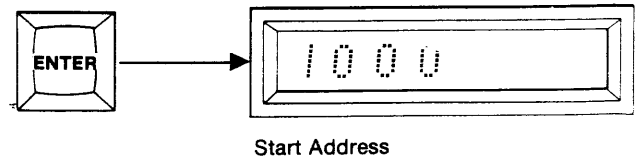

8. Use the keyboard to key in the desired Start Address of the block to be moved up. See Figure 7-3 for additional explanation.

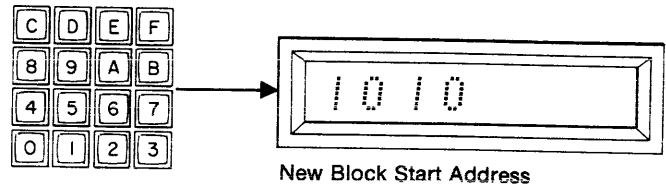

9. Depress ENTER. The default data to fill the vacated location(s) is displayed.

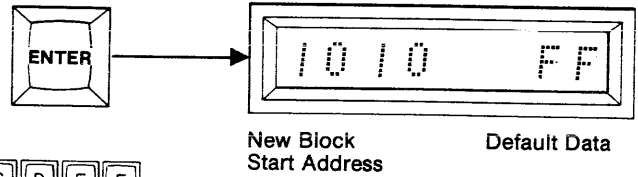

10. If desired, use the keyboard to key in other data to be used to fill vacated locations.

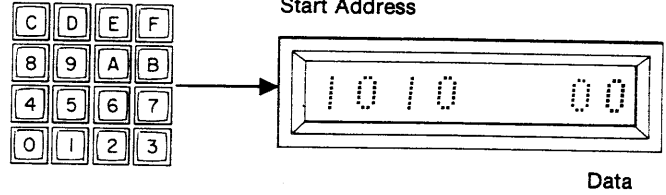

11. Depress ENTER. The previous data is accepted and the display shows "E04 AAA" to indicate Edit Delete Active. The Write Mode LED is lit. The M980 deletes all of the data between the block Start Address and the address keyed in step 8. It then fills all of the vacated locations with the data in the display prior to step 11. Upon completion of the operation, the "AAA" in the display is replaced with "F" to indicate Finished. A steady tone sounds if the AUDIO switch is ON. The Write Mode LED is extinguished.

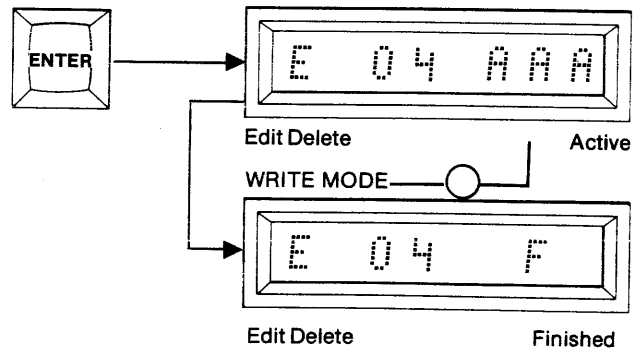

NOTE: Depending upon the size of the block to be deleted, this operation may take up to 60 seconds to perform.

Buffer Edit — Block Move (example shown is for an 8Kx8 RAM Buffer)

When Block Moving data the original data is left intact unless overlapping occurs. The example shown in Figure 7-4 is for moving address locations 1000 through 12FF to addresses 1800 through 1AFF.

1. Select the switches as shown. The AUDIO switch is optional.



2. Depress RESET. The 8 hex displays are blank. A Personality Module is not necessary. "E4" is displayed if a Personality Module is not present. A warbling tone will sound if the AUDIO switch is ON. You may now continue.

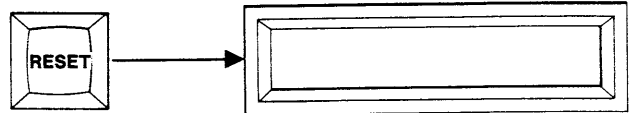

3. Depress EDIT. "E 00" is displayed to indicate Edit Mode 00.

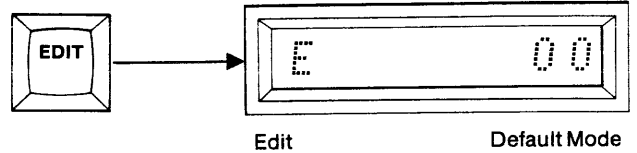

4. Using the hex keyboard, key in "05" to select Block Move Mode.

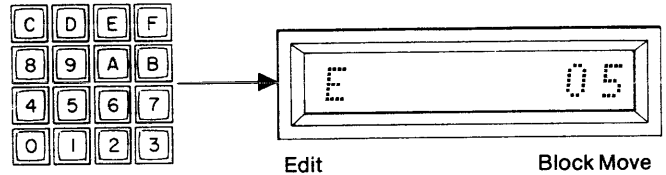

5. Depress ENTER. Block Move is accepted and the First and Last Addresses of the Buffer are displayed.

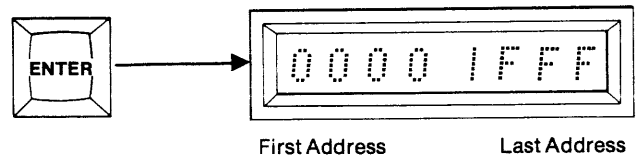

6. Use the hex keyboard to key in the Start and End Addresses of the block to be moved.

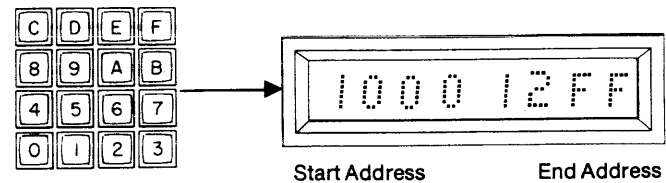

7. Depress ENTER. The Start and End Addresses are accepted and the Start Address of the block is displayed.

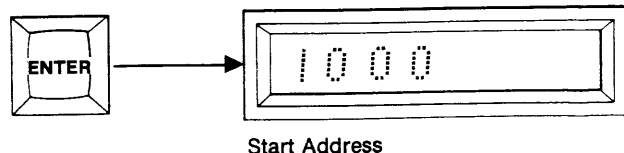

8. Use the hex keyboard to key in the address at which the new block starts.

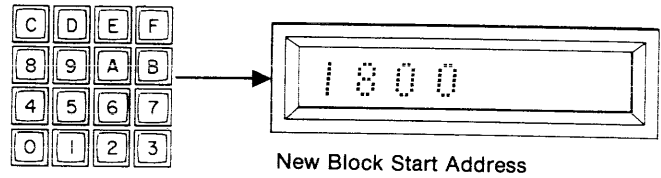

9. Depress ENTER. The new block Start Address is accepted and "E05 AAA" is displayed to indicate Edit Block Move Active. The Write Mode LED is lit. Upon completion of the operation, the "AAA" is replaced with "F" to indicate Finished. A steady tone sounds if the AUDIO switch is ON, and the Write Mode LED is extinguished.

NOTE: Depending upon the size of the block to be moved, this operation may take up to 60 seconds to program.

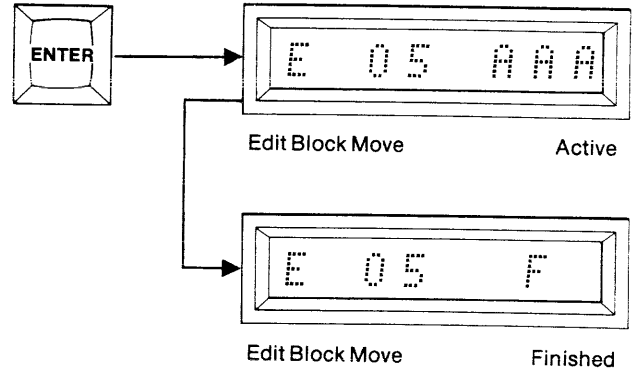

A) Block Move forward without overlapping. Both areas finish with block data.

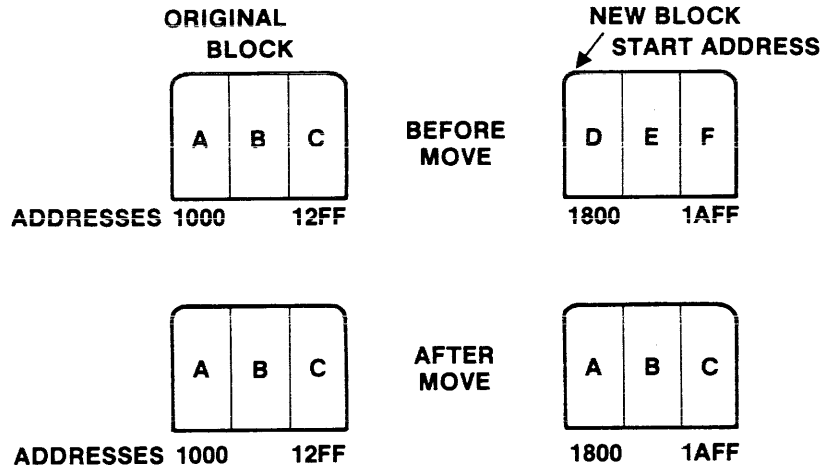

B) Block Move forward with overlapping. New block overwrites original.

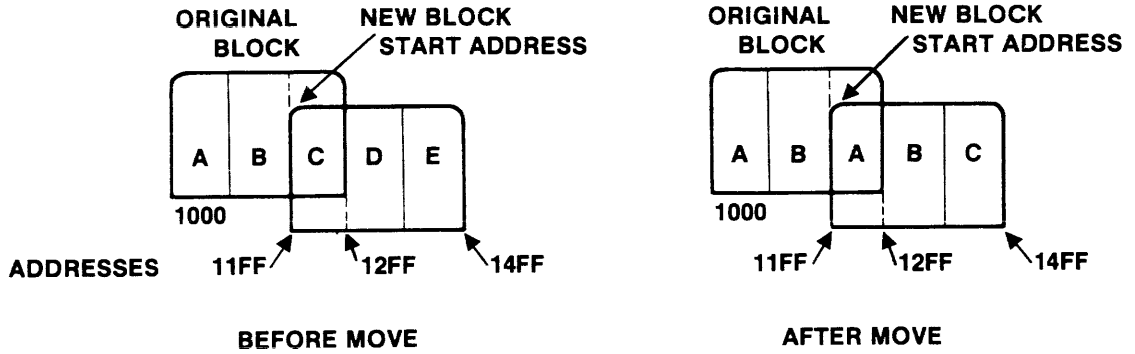

C) Block Move backwards without overlapping. Both areas finish with block data.

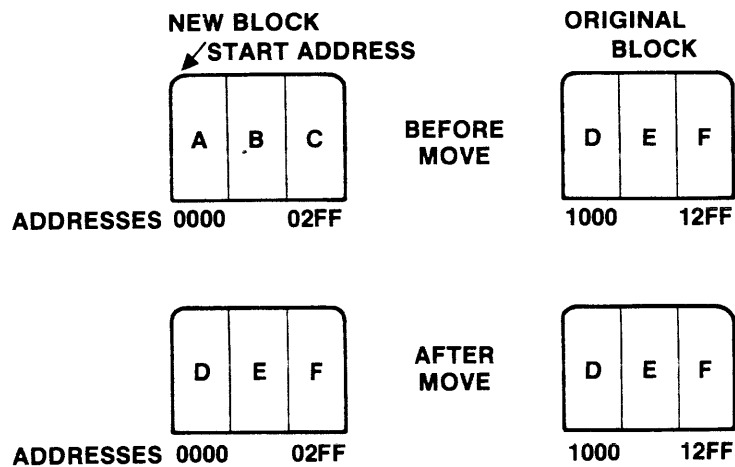

Figure 7-4 — Illustrations of Buffer Block Move Operations
(In the examples, each internal lettered block is equal to 256 locations.)

D) Block Move backwards with overlapping. New block overwrites original.

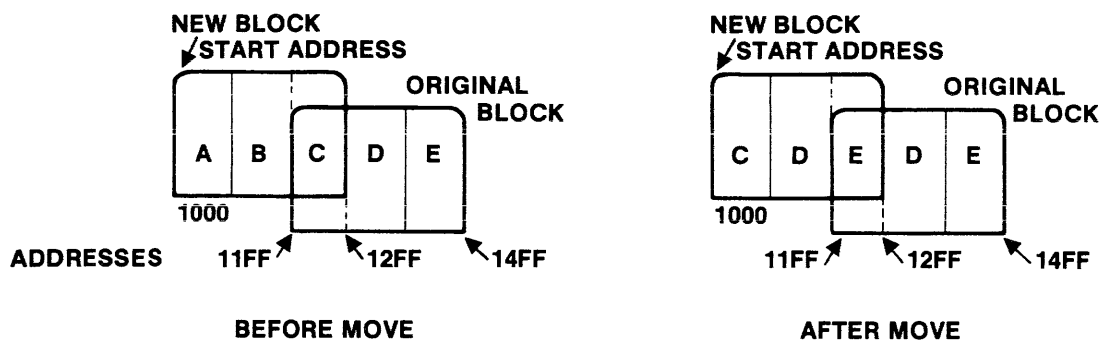

Figure 7-4 — Illustrations of Buffer Block Move Operations
(In the examples, each internal lettered block is equal to 256 locations.)

Buffer Edit — Nibble Swap (example shown is for an 8Kx8 RAM Buffer)

In the Nibble Swap operation the MSD of each 8-bit Buffer location is swapped with the LSD of the same location. (See Figure 7-5.)

1. Select the switches as shown. The AUDIO switch is optional.



2. Depress RESET. The 8 hex displays are blank. A Personality Module is not necessary. "E4" is displayed if a Personality Module is not present. A warbling tone will sound if the AUDIO switch is ON. You may now continue.

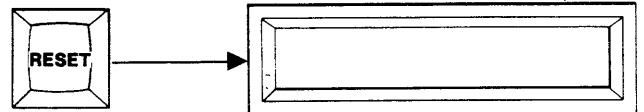

3. Depress EDIT. "E 00" is displayed to indicate Edit Mode 00.

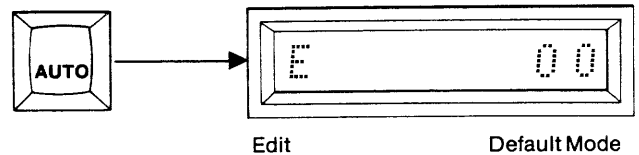

4. Using the hex keyboard, key in "06" to select Nibble Swap Mode.

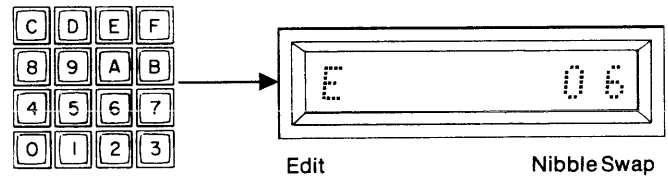

5. Depress ENTER. Nibble Swap is accepted and the First and Last Addresses of the Buffer are displayed.

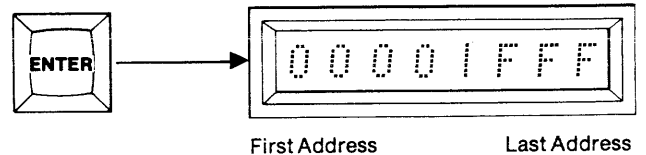

6. To Nibble Swap the entire contents of the Buffer, go to step 7. To Nibble Swap a limited field, use the hex keyboard to key in new Start and End Addresses.

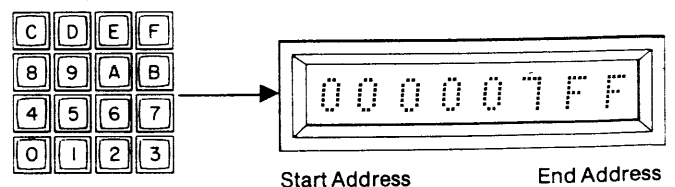

7. Depress ENTER. The Start and End Addresses are accepted and "E06 AAA" is displayed to indicate Edit Nibble Swap Active. The Write Mode LED is lit. Upon completion of the operation, the "AAA" is replaced with "F" to indicate Finished. A steady tone sounds if the Audio switch is ON. The Write Mode LED is extinguished.

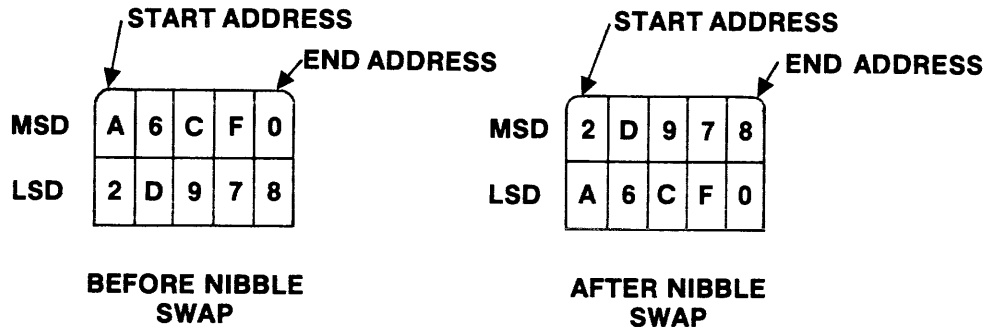
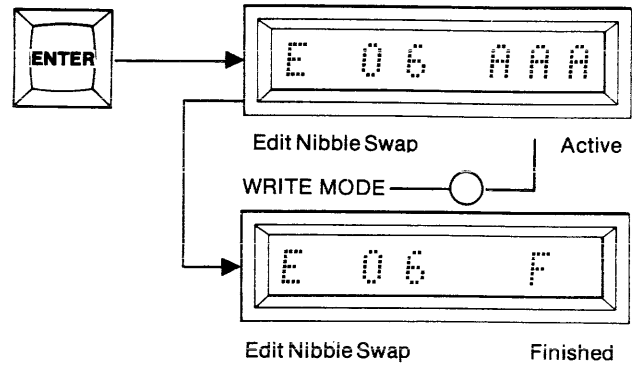

Figure 7-5 — Illustration of Nibble Swap

Buffer Edit — Hex Pack

An 8 bit byte of data may be expressed as two hexadecimal digits. For example, 01100111 is expressed in hexadecimal notation as 67. If both hexadecimal digits have meaning, then the 8 bit data byte is referred to as being in a Packed form. When the least significant hexadecimal digit has meaning and the most significant digit is treated as “don't care”, the 8 bit data byte is referred to as being in the Unpacked form.

In the Hex Pack mode of operation, the Buffer Start/End Addresses of the least significant digit field and the Start Address of the most significant digit field are selected. When the Hex Pack operation is complete, the Buffer address field defined for the least significant digit will contain the Hex Packed data. The most significant digit address field remains unaltered.

1. Select the switches as shown. The AUDIO switch is optional.

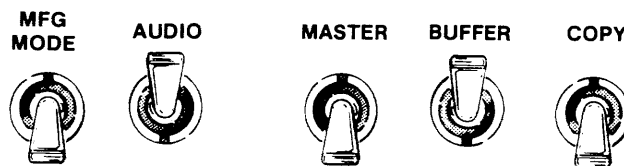

2. Depress RESET. The 8 hex displays are blank.

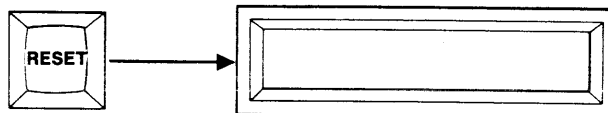

3. Depress EDIT. “E 00” is displayed to indicate Edit mode 00.

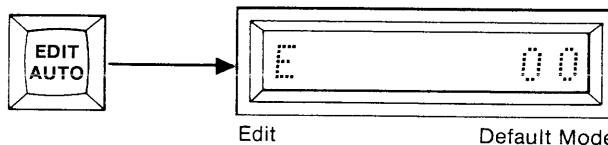

4. Using the hex keyboard, key in “07” to select the Hex Pack mode.

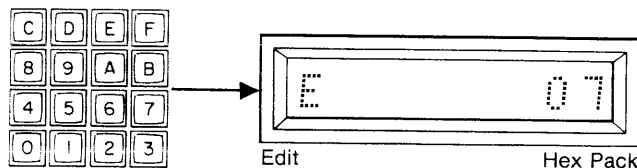

5. Depress ENTER. Hex Pack is accepted and the First and Last Addresses of the Buffer are displayed.

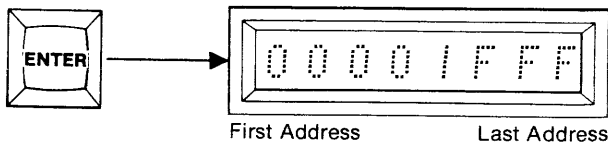

6. Use the hex keyboard to key a Start and End Address for the least significant digit of the Packed field. Use the CLEAR key to clear miskeyed characters. See SECTION 10 for further information.

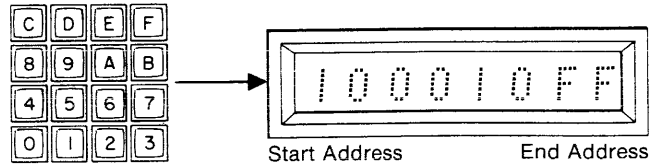

7. Depress ENTER. The Start and End Addresses are accepted. The display shows the Start Address for the second field containing the most significant digit which is to be Packed.

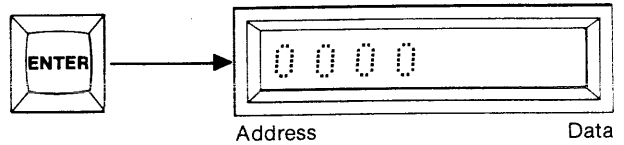

8. Use the hex keyboard to key the second field Start Address. Use the CLEAR key to clear miskeyed characters.

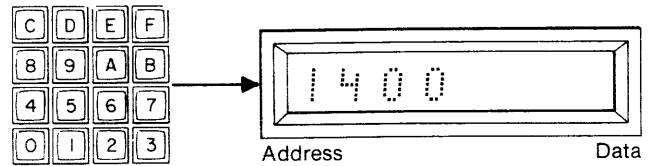

9. Depress ENTER. The Write mode LED is ON. The display shows "E 07 AAA" to indicate Edit Hex Pack Active. Upon completion of the operation, the "AAA" is replaced with an "F" to indicate Finished. A steady tone sounds if the AUDIO switch is ON. The Write mode LED is switched OFF.

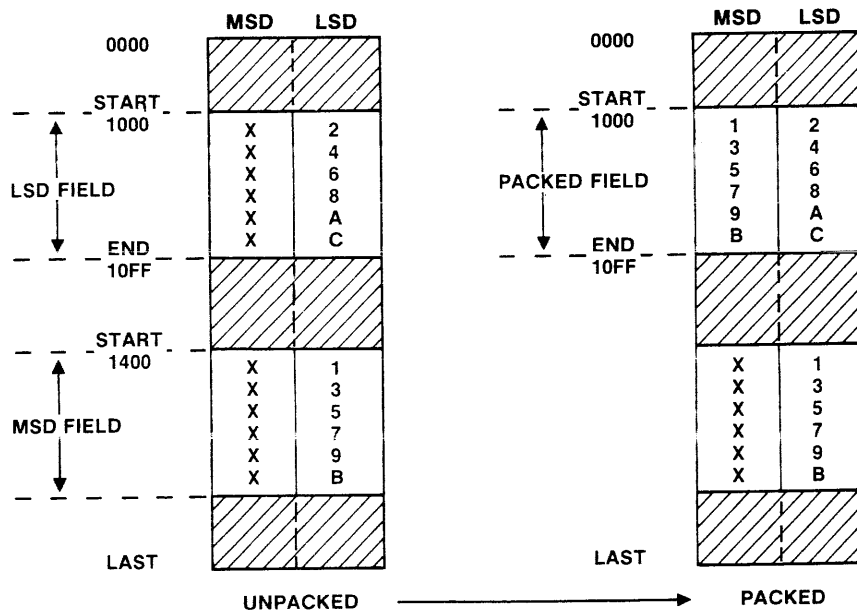
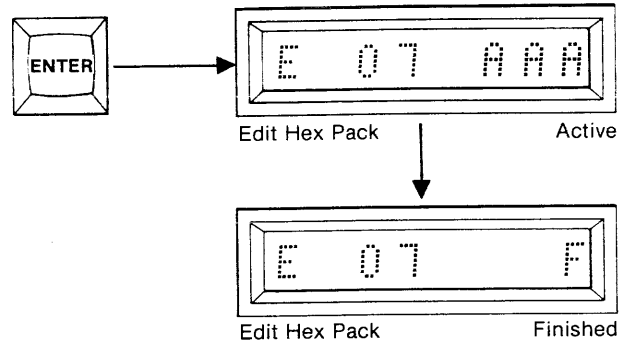

Buffer Edit — Hex Unpack

In the Hex Unpack mode of operation, the Buffer address field is defined for the data block to be unpacked. A Start Address is then defined for the beginning of the Buffer address field where the the most significant digit in unpacked form is stored. The least significant digit is stored in the unpacked form in the same address field as that of the data block that is unpacked.

1. Select the switches as shown. The AUDIO switch is optional.

**MFG
MODE**



AUDIO



MASTER



BUFFER



COPY



2. Depress RESET. The 8 hex displays are blank.

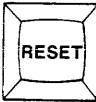

3. Depress EDIT. "E 00" is displayed to indicate Edit mode 00.



E
00

Edit Default Mode

4. Using the hex keyboard, key in "08" to select the Hex Unpack mode.

C	D	E	F
B	9	A	B
4	5	6	7
0	1	2	3

E
08

Edit Hex Unpack

5. Depress ENTER. Hex Unpack is accepted and the First and Last Addresses of the Buffer are displayed.

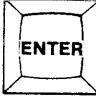

0000
1FFF

First Address Last Address

6. Use the hex keyboard to begin a Start and End Address field for the block of data to be Unpacked. Use the CLEAR key to clear miskeyed characters. See SECTION 10 for further information.

C	D	E	F
8	9	A	B
4	5	6	7
0	1	2	3

1000
10FF

Start Address End Address

7. Depress ENTER. The Start and End Addresses are accepted. The display shows the Start Address for the second field where the most significant digit in Unpacked form is stored.

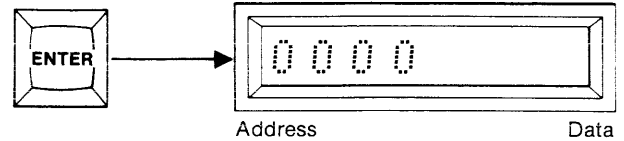

8. Use the hex keyboard to key the second field Start Address. Use the CLEAR key to clear miskeyed characters.

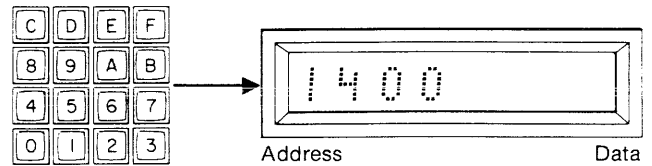

9. Depress ENTER. The Write mode LED is ON. The display shows "E 08 AAA" to indicate Edit Hex Pack Active. Upon completion of the operation, the "AAA" is replaced with an "F" to indicate Finished. A steady tone sounds if the AUDIO switch is ON. The Write mode LED is switched OFF.

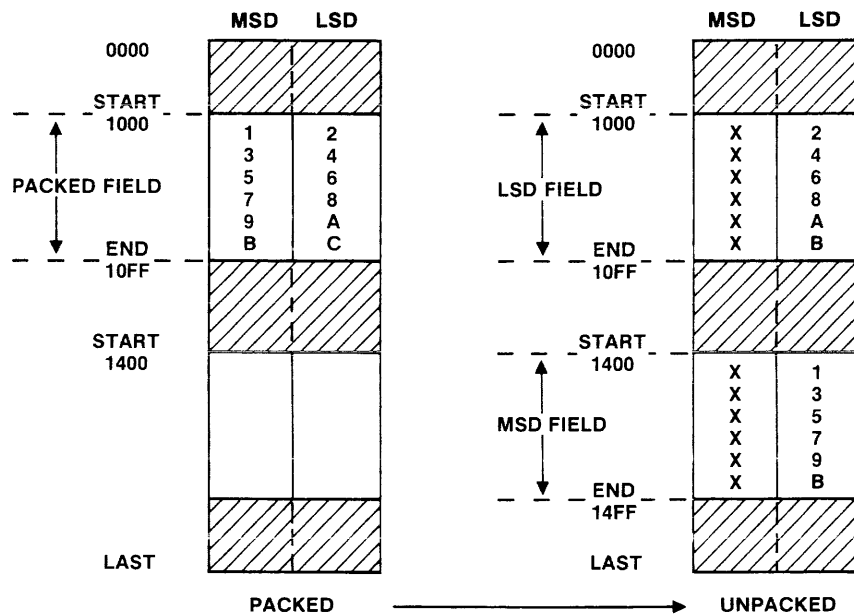
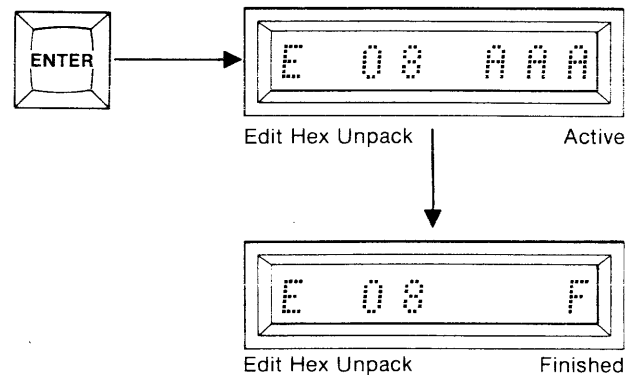

MANUFACTURING MODE

The Manufacturing Mode is a mode which operates with minimum operator interaction. To achieve this operating simplicity the mode is restricted to:

1. Master-to-Copy operations only
2. Full PROM field only

In the Manufacturing Mode, the M980 can operate in one of four sub-modes: Blank Check, Duplicate, Compare, or Automatic (a mode which sequences automatically through the other operations). The AUDIO tone, selected by a toggle switch, is optional.

Manufacturing Mode — Automatic Sequencing Operation

1. Insert the appropriate Personality Module and select switches as shown. Insert the PROM to be used as the Master PROM into the MASTER socket and the PROM to be copied in the COPY socket.



2. Depress RESET. The 8 hex displays are blank.

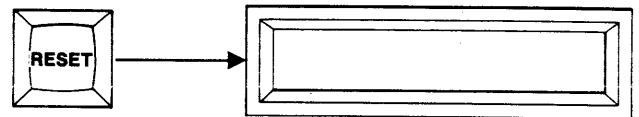

3. Depress AUTO. An "A" appears in the display.

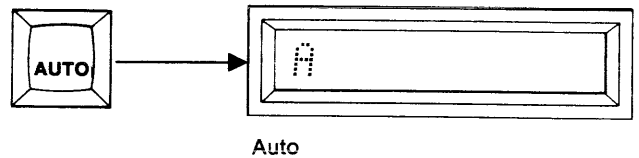

4. Depress ENTER. This initiates an automatic sequence progressing from: Blank Check to Duplicate (Write Mode LED lit) to Compare.

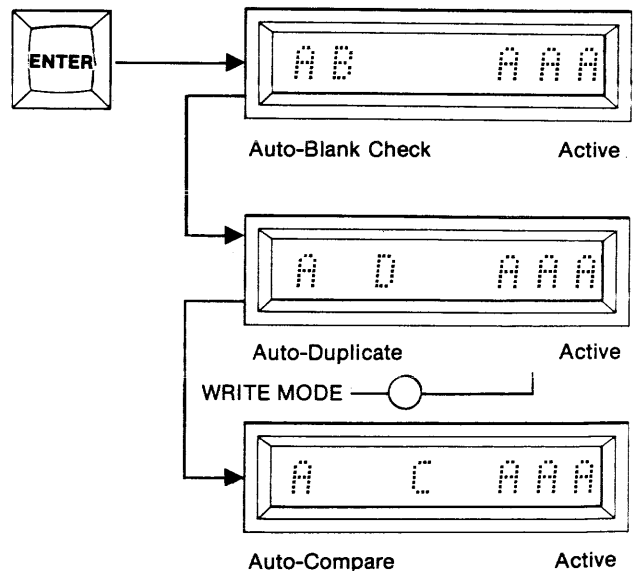

5. Upon the successful conclusion of the operation an "F" is displayed replacing the "AAA". A steady tone sounds if the AUDIO switch is ON.

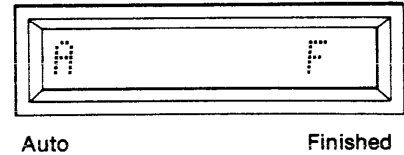

6. If an error is detected, the M980 halts and displays the operation code "B" (Blank Check) or "C" (Compare) and "E1" to denote Error. A warbling tone sounds if the AUDIO toggle switch is in the ON position. NOTE: All modules that program the 2708 and TMS2716 (PM9005A, PM9053A, PM9051A, and PM9060A) respond differently. Refer to SECTION 11, Failure to Program Operations. Also, Gang Modules for PROMs other than the 2708 or TMS2716 continue through to the end of the operation before halting.

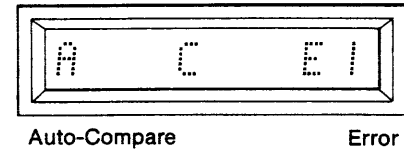
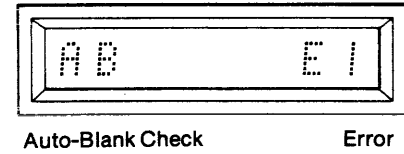

7. To repeat the entire sequence with new Copy PROM, return to step 4.

Summary of Automatic Sequencing Operation

1. Insert Personality Module, PROM to be programmed, PROM to be copied, and select switches as follows; MFG MODE (ON), AUDIO (optional), MASTER (ON), BUFFER (OFF) COPY (ON).
2. Depress RESET. Display is blank.
3. Depress AUTO. "A" is displayed.
4. Depress ENTER. Automatic sequencing commences. The display shows "AB AAA", "AD AAA", "AC AAA".
5. When complete, "A F" is displayed.
6. If an error is detected "B" or "C" and "E1" are displayed.
7. Optional. Load new Copy PROM. Depress ENTER to repeat Blank Check to Duplicate to Compare operation.

**Manufacturing Mode — Single Operation
(Blank Check, Duplicate, Compare)**

1. Insert the appropriate Personality Module and select switches as shown. Insert the PROM to be used as the Master PROM into the MASTER socket and the PROM to be copied into the COPY socket.



2. Depress RESET. The 8 hex displays are blank.

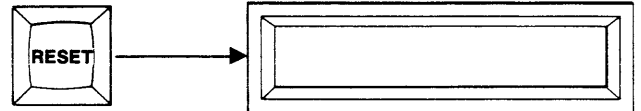

3. Depress BLNK CHCK(Blank Check), DUP(Duplicate) or CMPR(Compare). A "B", "D", or "C" is displayed to indicate the mode key depressed.

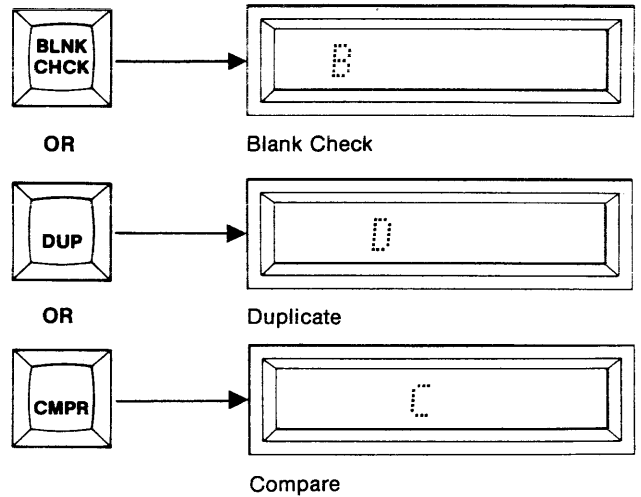

4. Depress ENTER. The operation automatically begins and "AAA" is displayed in the right-most display to indicate Active.

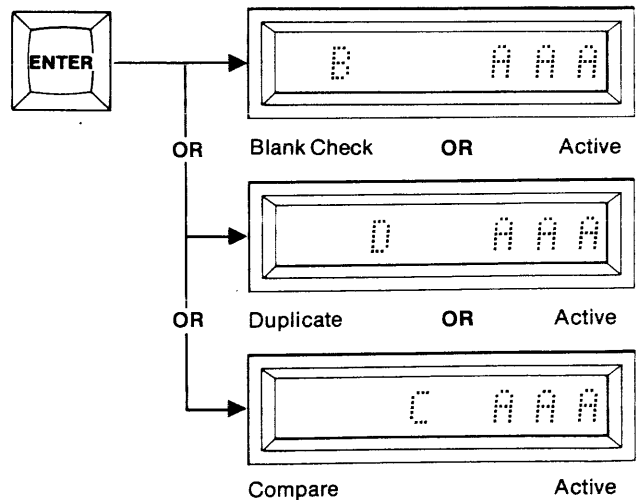

5. Upon the successful conclusion of the operation an "F" is displayed replacing the "AAA". A steady tone sounds if the AUDIO switch is ON.

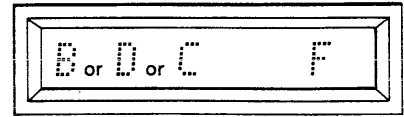

Blank Check or Finished
Duplicate or
Compare

6. To repeat the entire sequence, return to step 4.

7. If an error is detected, the M980 halts and displays the operation code "B", "D" or "C" and "E1" to denote Error. A warbling tone sounds if the AUDIO toggle switch is in the ON position.

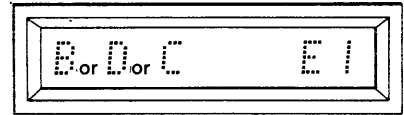

Blank Check or Error
Duplicate or
Compare

Summary of Single Operation

1. Insert Personality Module, PROM to be programmed, PROM to be copied, and select switches as follows; MFG MODE (ON), AUDIO (optional), MASTER (ON), BUFFER (OFF) COPY (ON).
2. Depress RESET. Display is blank.
3. Depress BLNK CHCK, DUP, or CMPR. The display shows "B", "D", or "C".
4. Depress ENTER. The display shows "B AAA", "D AAA", "C AAA".
5. When complete, "A F" is displayed.
6. Optional. Depress ENTER to repeat the operation.
7. If an error is detected "B", "D", or "C" and "E1" are displayed.

ENGINEERING AUTO-SEQUENCING MODE

The Engineering Automatic sequencing Mode provides the convenience of the Manufacturing Mode without the restrictions on data source and address field size. As in the other operational modes the use of the AUDIO tone is optional.

Engineering Auto-Sequence Mode—Buffer to Copy Operation (example shown is for 2Kx8 PROM)

1. Insert the appropriate Personality Module and select switches as shown. Insert the PROM to be copied in the COPY socket.

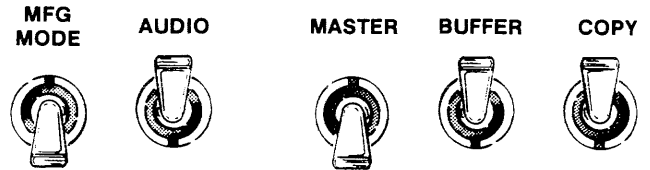

2. Depress RESET. The 8 hex displays are blank.

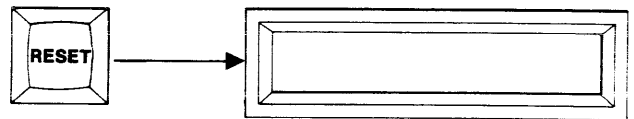

3. Depress AUTO. The displays show the First and Last Addresses of the Copy PROM.

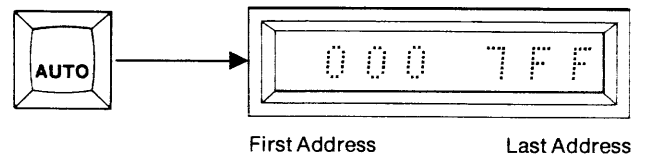

4. To program the entire contents of the Copy PROM, go to step 5. To operate over a limited field use the hex keyboard to key in a new Start and End Address, MSD first.

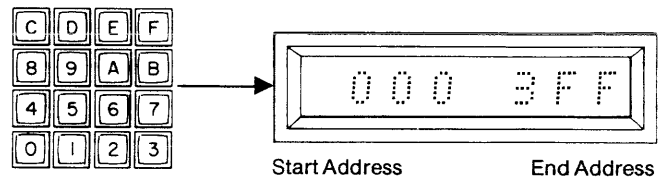

5. Depress ENTER. "0000" is displayed to indicate the default Buffer First Address.

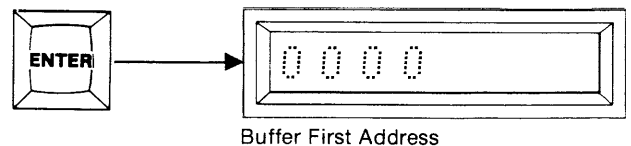

6. If a different Buffer Start Address is desired, use the keyboard to key in a new Start Address otherwise, proceed to step 7.

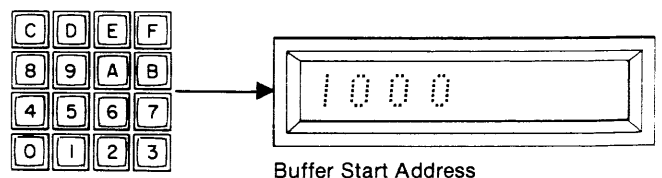

7. Depress ENTER. The displayed Buffer Start Address is accepted and Automatic Sequencing begins.

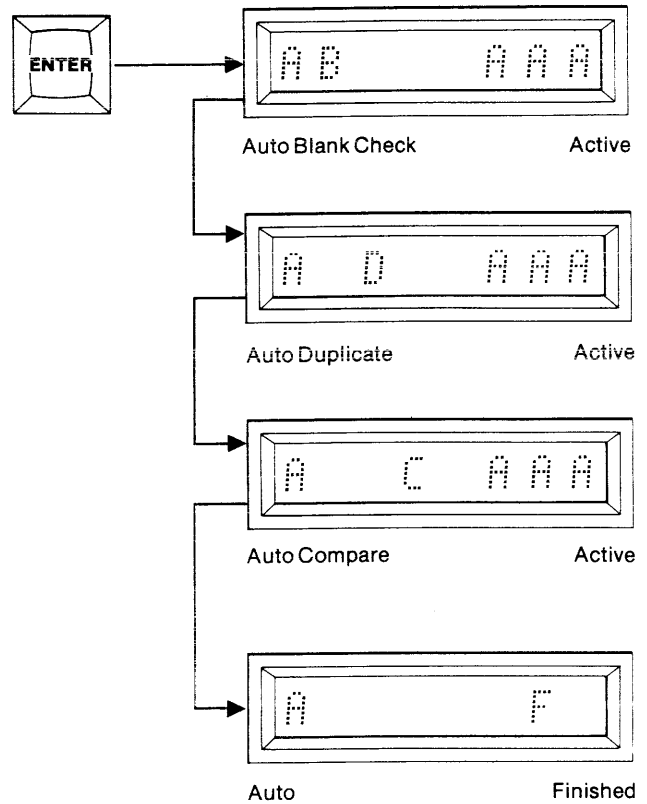

8. Upon completion of the sequence, an "F" replaces the "AAA" to indicate Finished. A steady tone sounds if the AUDIO switch is ON.

9. Depress ENTER to repeat the operation. The previous Start and End Addresses of the Copy PROM are displayed. You may now continue with step 4. Each depression of ENTER recalls the next previous address.

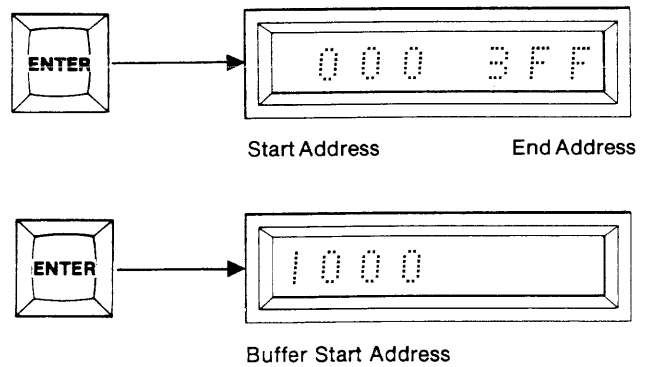

10. If an error is detected, the Buffer address and data are displayed. Gang modules respond differently at this point. A warbling tone sounds if the AUDIO switch is ON. Depress Key C to display the Copy address and data.

NOTE: All modules that program the 2708 and TMS2716 (PM9005A, PM9053A, PM9051A, and PM9060A) respond differently. Refer to SECTION 11, Failure to Program Operations. Also, Gang Modules for PROMs other than the 2708 or TMS2716 continue through to the end of the operation before halting.

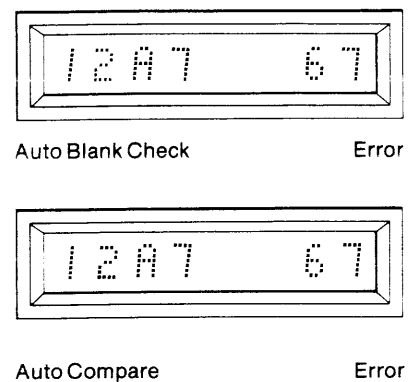

Summary of Buffer to Copy Operation

1. Insert Personality Module, PROM to be programmed, and select switches as follows; MFG MODE (OFF), AUDIO (optional), MASTER (OFF), BUFFER (ON), COPY (ON).
2. Depress RESET. Display is blank.
3. Depress AUTO. The First and Last Addresses of the Copy PROM are displayed.
4. Key in a new Start and End Addresses if desired.
5. Depress ENTER. The First Address of the Buffer is displayed.
6. Key in a new Buffer Start Address if desired.
7. Depress ENTER. The Auto sequencing begins. The display shows "AB AAA", "AD AAA", or AC AAA".
8. When complete the "AAA" is replaced with "F" to indicate Finished.
9. Optional. Depress ENTER to repeat the operation and return to step 4.
10. If an error is detected, the address and data are displayed.

**Engineering Auto-Sequence Mode—Master to Copy Operation
(example shown is for 2Kx8 PROM)**

1. Insert the appropriate Personality Module and select switches as shown. Insert the PROM to be copied into the Copy socket.

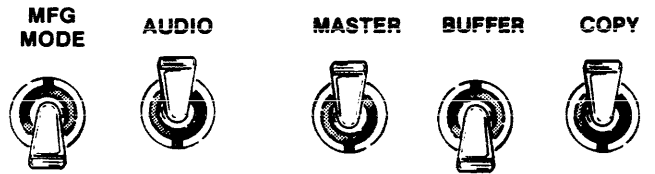

2. Depress RESET. The 8 hex displays are blank.

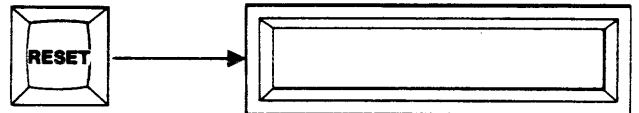

3. Depress AUTO. The displays show the First and Last Addresses of the Copy PROM.

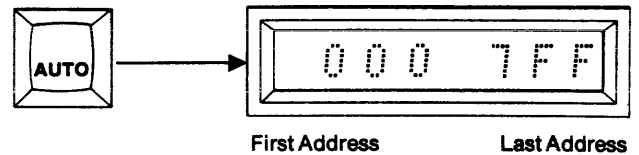

4. To Duplicate the entire contents of the Copy PROM, go to step 5. To Duplicate a limited field, use the hex keyboard to key in a new Start and End Address, MSD first.

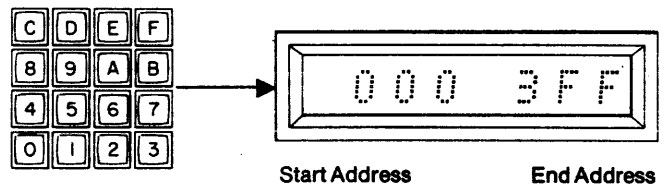

5. Depress ENTER. This initiates the Auto-Sequencing operation.

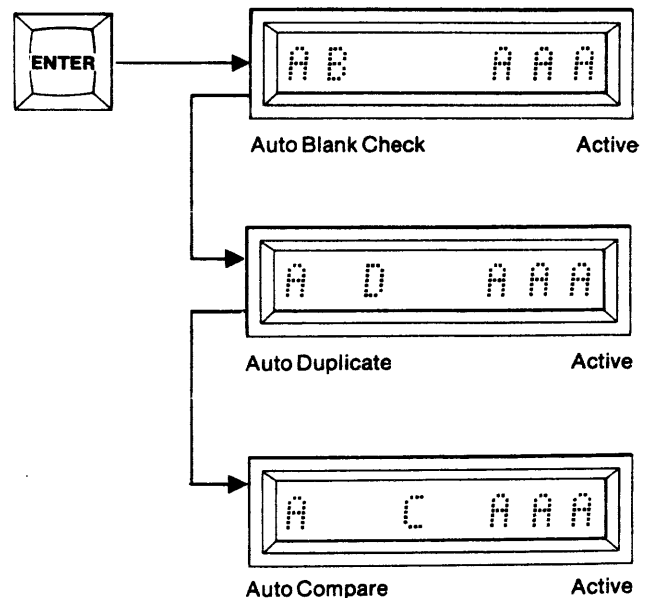

- Upon completion of the sequence, an "F" replaces the "AAA" to indicate Finished. A steady tone sounds if the AUDIO switch is ON.

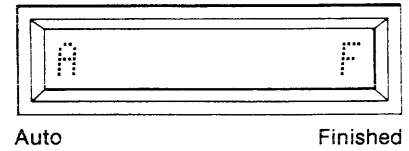

- Depress ENTER to repeat the Automatic Mode without resetting. This displays the previous Start and End Addresses and returns you to step 4 and/or 5.

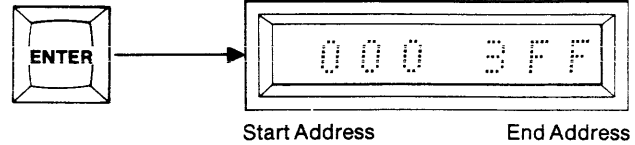

- If an error is detected, the M980 halts and displays the Master address and data. A warbling tone sounds if the AUDIO switch is ON. Depress Key C to display the Copy address and data.

NOTE: All modules that program the 2708 and TMS2716 (PM9005A, PM9051A, PM9053A, and PM9060A) respond differently. Refer to SECTION 11, Failure to Program Operations. Also, Gang Modules for PROMs other than the 2708 or TMS2716 continue through to the end of the operation before halting.

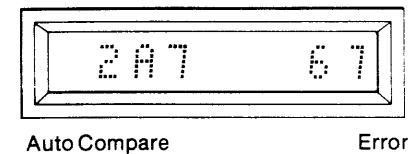
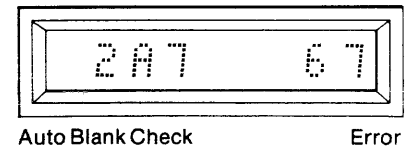

Summary of Master to Copy Operation

- Insert Personality Module, PROM to be programmed, PROM to be copied, select switches as follows; MFG MODE (OFF), AUDIO (optional), MASTER (ON), BUFFER (OFF), COPY (ON).
- Depress RESET. Display is blank.
- Depress AUTO. First and Last Addresses of the Master/Copy are shown.
- Depress ENTER. The display will show "AB AAA", "A D AAA", "A C AAA".
- When complete, the "AAA" will be replaced with "F".
- To repeat, depress ENTER. You are now back to step 4. The M980 halts and displays the address and data to indicate an error.

CLEAR KEY OPERATIONS

General Description

In the M980 the Clear operation is defined as: An operation that removes the present condition, and allows a correction of that condition to be implemented without resetting all of the previous operations.

The CLEAR key on the M980 has several functions, depending upon the mode of the M980. In keyboard entry situations, it allows the correction of hex keyboard entries. In the Read mode, it allows recall of the previous address and data (decrement). Finally, it is used to abort Duplicate or Program modes upon an error indication, without changing any of the previous operation of sequences.

The CLEAR key is active to clear the displays after a hex key is used to key in information, and before the ENTER key is depressed. In this mode, after the hex character is displayed, the CLEAR key may be used to clear that character and any characters to the left, one character for each depression of the CLEAR key. (See the following example for a step-by-step explanation.)

In the Read mode the CLEAR key is active to decrement the address. By depressing the CLEAR key, the previous address and its corresponding data is displayed.

In the Duplicate and Program modes, the CLEAR key can be used to abort the mode when an error is indicated. When the error is displayed, the depression of CLEAR automatically aborts the operation and displays "F" for Finished. The previous Start and End Addresses of the operation are still intact in the M980's memory. By depressing the ENTER key, a repeat of the operation may be implemented, starting with the address field definition. For more information on procedures during a Programming Failure, see SECTION 11.

Example of CLEAR Key Operation in Read Mode

1. Insert Personality Module and select the switches as shown. AUDIO switch is optional. Insert the PROM to be read into the MASTER socket of the Personality Module.



2. Depress RESET. The 8 hex displays are blank.

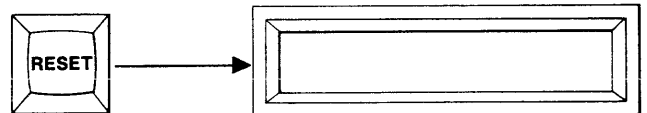

3. Depress READ. The First and Last Addresses of the Master are displayed.

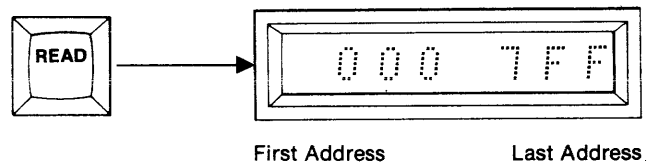

4. To Read the entire contents of the Master PROM, starting with the First Address, depress ENTER. To Read a limited address field use the hex keyboard to key in a new Start and End Address, MSD first. If an incorrect character is keyed, use the CLEAR key to correct it.

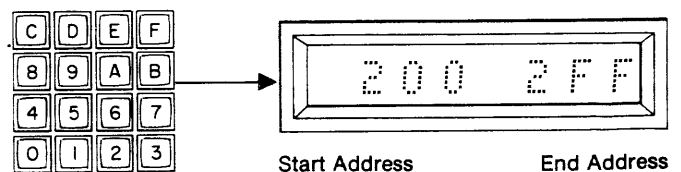

5. Depress the CLEAR key twice. The right-most two characters are cleared. Depressing the CLEAR key additional times will clear correspondingly more digits.

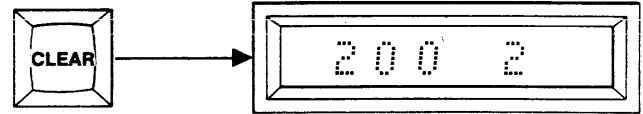
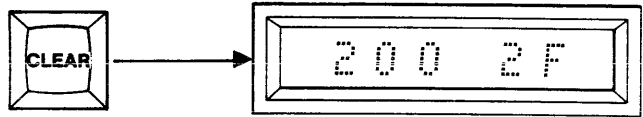

6. Use the hex keyboard to key in a revised address.

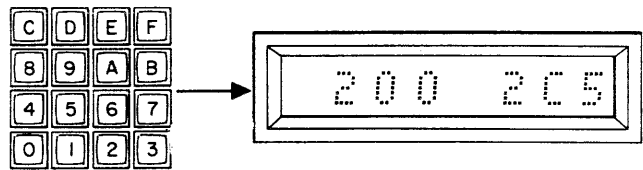

7. Depressing ENTER will cause the operation to proceed over the revised range.

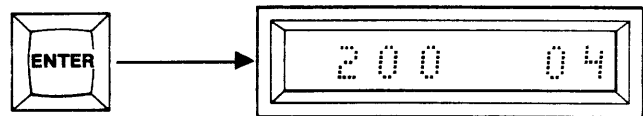

FAILURE TO PROGRAM

Fusible PROMs:

As it attempts to program the bad location, the M980 typically takes less than a second before indicating error, although delays of up to 12 seconds are possible. With many bipolar PROMs the operator may retry the failed location by depressing ENTER (check PROM manufacturers specifications to determine whether re-try is permissible). The display will then indicate the next sequential address if re-try is successful, or "AAA" is displayed if in DUP mode. If unsuccessful, the error indication is displayed again. To step over the failed location, the operator may depress the CLEAR key and an "F" will appear for Finished. The operator may now reselect the mode and redefine the address field, using the address after the failed location as a Start Address. In the Duplicate mode the operator may examine data in the corresponding address in Master PROM, Buffer, or Copy PROM by depressing key A to see Master PROM data, key B to see Buffer data, or key C to see Copy PROM data. (Refer to the example shown below.)

UV Erasable PROMs:

Following an unsuccessful attempt at programming a location, the operator may step over a failed location by depressing the ENTER key. In the Duplicate mode the operator may see what is in the corresponding address in the Master PROM, Buffer, or Copy PROM by depressing key A to see Master data, key B to see Buffer data, or key C to see Copy PROM data.

To step to the end of the operation, the operator may depress the CLEAR key and an "F" appears to indicate Finished. However, some Personality Modules have special software routines that prevent this operation. They include the PM9005A, PM9053A, PM9051A and PM9060A. For these modules it is necessary to depress RESET to abort a duplication process. The display for these PROMs also differs from the normal display (refer to their respective Failure Instructions at the end of this section).

NOTE: Do not try to reprogram a failed UV Erasable PROM without complete erasure since this will result in a marginal data condition.

Example: Duplication of data from the Master PROM to the Copy PROM

1. An error occurs in address 020. The M980 halts and displays the address and the source (Master) data for that address. (Example: "FC")

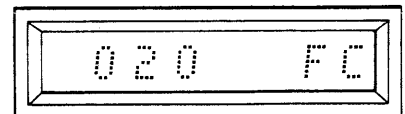
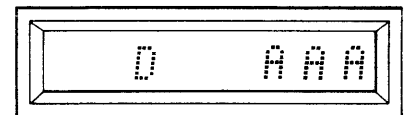

2. The operator may now examine the Copy PROM data by depressing key C. (Example "FF")

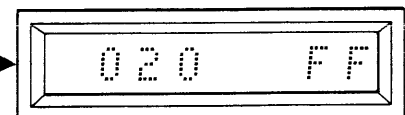
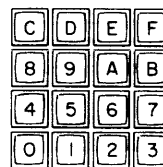

3. The operator may examine the Master PROM data by depressing key A, OR

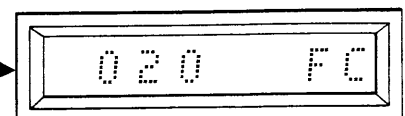
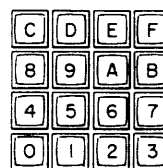

4. Depress ENTER to bypass the location (for UV and some bipolar PROMs). The M980 steps over the failed location and tries the next sequential location. For bipolar PROMs, depressing ENTER will retry to program the same location again. If the retry or next location fail to program, the previous steps may be followed.

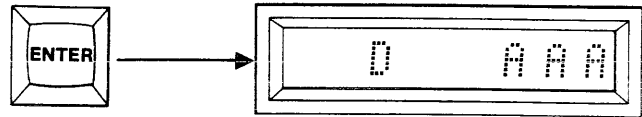

5. The operator may abort the operation (without pressing RESET, to re-enter the mode and address information) by depressing the CLEAR key. This causes the M980 to step to the end of the operation, displaying an "F" for Finished.

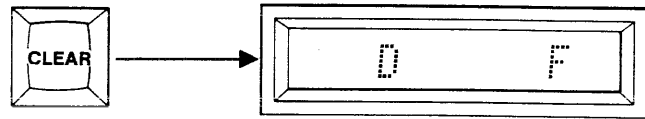

All 2708 and TMS2716 Modules show a programming count of 00-99 when programming. After the 99th pass the program carried by these modules performs a complete Compare operation independent of the M980. The display is blanked for Gang Personality Modules while the module performs its own Compare.

PM9005A and PM9053A

The address and data for the earliest failed location are displayed. Since this operation is independent of the M980, a tone does not sound, regardless of the position of the AUDIO switch. Depressing ENTER sequences to the next failed location. In either Manufacturing or Engineering Auto Sequencing mode, the operator may have to depress ENTER many times in order to reach the point where the automatic sequence resumes. It is therefore suggested that the operator abort these operations by pressing RESET with this module.

PM9051A and PM9060A

Any error results in a display of "E"; a tone will not sound. Depressing ENTER causes the M980 to display "F" (or continue in Manufacturing or Engineering Auto Sequence). The LEDs below each COPY socket or the Gang Module indicate which PROM has failed (on = fail; off = pass).

BUFFER APPLICATIONS

The CMOS Buffer included in the M980 PROM Programmer allows useful data retention characteristics — it's battery back-up retains data for a minimum of seven days with power removed from the M980. Thus, Personality Modules may be exchanged without RAM Buffer data loss, permitting the exchange of data between different types of PROMs without resorting to paper tape or other alternate storage media. The M980 editing features (see SECTION 7) permit 8-bit data to be programmed into two 4-bit PROMs with ease. Further expansion of the concept, to 16-bit PROMs, is also provided.

The applications presented in this section are indicative of the utility of these features.

Example 1

A 74S471 PROM (256x8) is to replace two 74S287 PROMs (256x4 each). Move the 74S287 data to the Buffer, then program a 74S471 as follows: Turn unit power OFF, insert a PM 9047 (74S287) Personality Module with a PA16-1 pinout adapter and turn power back ON. Then,

STEP	MODE	DISPLAY	OPERATOR RESPONSE	COMMENT
1.	DUP (Master to Buffer)	00 FF 0000	— ENTER — ENTER	Move 74S287 #1 to Buffer Least significant digit of 0000 to 00FF
2.	EDIT	0000 1FFF	06 ENTER 0000 00FF ENTER	Swap the upper and lower digit of each byte in the Buffer from 0000 to 00FF
3.	DUP	00 FF 0000	— ENTER — ENTER	Move 74S287 #2 to Buffer Least significant digit of 0000 to 00FF

The Buffer now holds the content of two 74S287 PROMs. PROM #1 is contained in the Most significant digit of the Address field and PROM #2 is contained in the Least significant digit of the Address field.

4. Switch the M980 power OFF, remove the PA16-1 pinout adapter and replace it with a PA20-2. Switch M980 power back ON.

STEP	MODE	DISPLAY	OPERATOR RESPONSE	COMMENT
5.	DUP (Buffer to Copy)	00 FF 0000	— ENTER — ENTER	Program a 74S471 with the Buffer Content

Example 2

A 2732 PROM (4Kx8) is to replace four 2708 PROMs (1Kx8 each). Move the 2708 data to the Buffer, then program a 2732 as follows: turn unit power OFF, insert a PM9005A (2708) Personality Module and turn power back ON. Then,

STEP	MODE	DISPLAY	OPERATOR RESPONSE	COMMENT
1. Insert 2708 #1 in the Master socket	DUP (Master to Buffer)	000 3FF 0000	— ENTER — ENTER	Move 2708 #1 data to Buffer (0000 to 03FF)
2. Insert 2708 #2 in the Master socket	DUP	000 3FF 0000	— ENTER 0400 ENTER	Move 2708 #2 data to Buffer (0400 to 07FF)
3. Insert 2708 #3 in the Master socket	DUP	000 3FF 0000	— ENTER 0800 ENTER	Move 2708 #3 data to Buffer (0800 to 0BFF)
4. Insert 2708 #4 in the Master socket	DUP	000 3FF 0000	— ENTER 0C00 ENTER	Move 2708 #4 data to Buffer (0C00 to 0FFF)

The Buffer now holds the content of four 2708 PROMs.

5. Switch the M980 power OFF, remove the PM9005A Personality Module and insert the PM9064 (2732) Personality Module. Switch M980 power back ON.

Now insert a blank 2732 PROM in the Copy socket, then

STEP	MODE	DISPLAY	OPERATOR RESPONSE	COMMENT
6.	DUP (Buffer to Copy)	000 FFF 0000	— ENTER — ENTER	Program 2732 with the Buffer content.

Example 3

Two 74S287 PROMs (256x4 each) are to replace a 74S471 PROM (256x8). Move the 74S471 data to the Buffer, then program the two 74S287 PROMs as follows: turn unit power OFF, insert a PM 9047 (74S471) Personality Module with a PA20-2 pinout adapter and turn power back ON. Then,

STEP	MODE	DISPLAY	OPERATOR RESPONSE	COMMENT
1.	Insert 74S471 in the Master socket			
	DUP (Master to Buffer)	00 FF 0000	— ENTER — ENTER	Move 74S471 data to Buffer

The Buffer now holds the content of the 74S471.

2. Switch the M980 power OFF, remove the PA20-2 pinout adapter and replace it with a PA16-1. Switch M980 power back on.

STEP	MODE	DISPLAY	OPERATOR RESPONSE	COMMENT
3.	Insert 74S287 #1 in the Copy socket			
	DUP (Buffer to Copy)	00 FF 0000	— ENTER — ENTER	Program a 74S287 with the Least significant digit of the Buffer content.
4.	EDIT		06 ENTER	Swap the upper and lower digit of each byte in the Buffer from 0000 to 00FF.
		0000 1FFF	0000 00FF ENTER	
5.	Insert 74S287 #2 in the Copy socket			
	DUP	00 FF 0000	— ENTER — ENTER	Program a 74S287 with the Least significant digit of the Buffer content.

ERROR INDICATIONS AND OPERATION MODES**ERROR INDICATIONS**

CODE	EXPLANATION
E0	Set-up error. The Source and Destination toggle switches are not in the proper position, e.g. a non-valid operation such as program MASTER.
E1	Data error. A failure to Blank Check, Program, Compare.
E2	No option. Option selected does not exist.
E3	Address error. Performing an operation and the address given cannot be complied with. Example: Duplicate Master to Buffer. If you try to move a 2K program into the last 1K of Buffer, this error indication will appear prior to attempting the operation.
E4	No Personality Module. A Personality Module is not installed. Buffer operation may continue.
E5	Option Interface not ready. Option selected, but when checked, the interface is not properly hooked up. Example: 9818 RS232C adapter installed but ON-LINE/OFF-LINE switch is in the OFF-LINE position.
E6	Communication CHECKSUM error. When using one of the interfaces, in which the checksum of each line is sent over the interface, and the checksum does not match, this error will be displayed. An example: Intel Format RS232C.
E7	Remote Control error indication: Response to the QXN command.

OPERATION CODES

CODE	EXPLANATION
A	Auto Mode selected.
AB AAA	Auto Blank Check Active.
AB E1	Auto Blank Check Error. (MFG Mode only).
AC AAA	Auto Compare Active.
AC E1	Auto Compare Error. (MFG Mode only).
AD AAA	Auto Duplicate Active.
A F	Auto Mode Finished.
B	Blank Check selected.
B AAA	Blank Check Active.
B E1	Blank Check Error. (MFG Mode only)
B F	Blank Check Finished.
C	Compare selected.
C AAA	Compare Active.
C E1	Compare Error. (MFG Mode only)
C F	Compare Finished.
C1-C8	Changes when Duplicating.
D	Duplicate selected.
D AAA	Duplicate Active.
D E1	Duplicate Error. (MFG Mode only)
D F	Duplicate Finished.

OPERATION CODES

CODE			EXPLANATION
E		00	Edit Reset Default Mode.
E00			Edit Word Size selected.
E00		04	Edit Word Size 4 bit.
E00		08	Edit Word Size 8 bit.
E00		12	Edit Word Size 12 bit.
E00		16	Edit Word Size 16 bit.
E00		F	Edit Word Size Finished.
E		00	Edit Reset Default mode. No operation. Asking for new mode to be entered.
E		01	Edit Invert Mode selected.
E01	AAA		Edit Invert Mode Active.
E01		F	Edit Invert Finished.
E		02	Edit Fill Buffer Mode selected.
E02	AAA		Edit Fill Buffer Active.
E02		F	Edit Fill Buffer Finished.
E		03	Edit Insert selected.
E03	AAA		Edit Insert Active.
E03		F	Edit Insert Finished.
E		04	Edit Delete selected.
E04	AAA		Edit Delete Active.
E04		F	Edit Delete Finished.
E		05	Edit BLock Move selected.
E05	AAA		Edit Block Move Active.
E05		F	Edit Block Move Finished.
E		06	Edit Nibble Swap selected.
E06	AAA		Edit Nibble Swap Active.
E06		F	Edit Nibble Swap Finished.
E		07	Hex Pack selected.
E07	AAA		Hex Pack Active.
E07		F	Hex Pack Finished.
E		08	Hex Unpack selected.
E08	AAA		Hex Unpack Active.
E08		F	Hex Unpack Finished.
		F	Finished.
0	dd	AAA	Interface option Output Active (see SECTION 15). No zero indicates Active idle.
D	dd	AAA	Remote Control Active
1	dd	AAA	Interface option Input Active (see SECTION 15). No zero indicates Active idle.
9811		dd	Paper Tape Reader interface selected.
9812		dd	TTY interface selected.
9814		dd	Parallel I/O interface selected.
9818		dd	RS232C interface selected.

SELF TEST OPERATIONS

The M980 is a Microprocessor-based instrument. The basic functioning of the machine, to display characters and respond to key closures, in itself shows that a large portion of the machine is functioning. This section describes additional tests, which may be used for confidence testing or for troubleshooting.

There are four types of tests:

- Keyboard Test
- Display Test
- Toggle Switch Test
- Ram Buffer Test

Keyboard Self-Test Selection

These test routines are located in software and are designed to interact with the user to test various hardware sections of the M980. The basic functioning of the keyboard involves strobing of the X-Y matrix formed by the keyboard switches. All tests are initiated in the same manner — if a key is found to be closed upon power up or RESET. The key depressed (down) is displayed in all of the hex displays until released. When the key is released, the Self-Test mode is active. Display shows 0 0 0 0.

Toggle Switch Test

Depressing Key 1 initiates the Toggle Switch Test, where the display corresponding to each toggle switch reflects the position of the switch (0 = down; 1 = up).

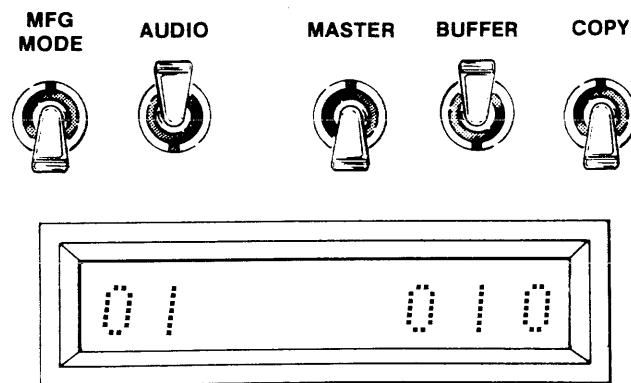

Depress CLEAR to return to Self-Test Selection and to display alternating 0's.

Keyboard (Keyswitch) Test

Depressing key 2 enters the Keyboard Test. As this test begins the displays are blank. Any hex key depressed is shown in the display and shifts from left to right, as additional keys are depressed and released. The function keys will respond as follows: EDIT/AUTO = 4; BLNK CHCK = 5; PROG/DUP = 6; READ/CMPR = 7; and ENTER = 0. When depressed the CLEAR key terminates this test and returns the M980 to the Self-Test Selection.

Display Test

Depressing Key 0 causes the Display Test to begin. In this test, all 8 displays cycle from 0 through F and repeat, allowing the operator to determine if any display segment, character, or display is not operating properly. When depressed the CLEAR key terminates this test and returns the M980 to the Self-Test Selection.

RAM Buffer Test)

When this test is performed, all existing data in the Buffer is altered. (Time for this test is \approx 5 min. for 16K). Depressing key 3 enters the RAM Buffer Test. The display will show the full buffer address range. Depress enter. The displays show "B DD AAA" while the test is in progress. The M980 writes all 0's into the Buffer and checks that the RAMs will accept the data. The next test writes alternating 1's into specified blocks and checks that block for data retention and all other blocks to make sure no other RAMs have the pattern.

When finished with data test (Display B DD AAA), an address test is initiated (Display B AA AAA), which tests the chip address lines for shorts and opens.

When Finished, the displays indicate "B AA F", then 0 0 0 0. The audio tone will sound when finished if selected.

If an error is found, the M980 indicates the address of the error, the data written to that location, and the data read back from that location, in the following manner.

- "AAAA" = Address of failure.
- "D₁D₁" = Data written to that address.
- "D₂D₂" = Data read back from that address.

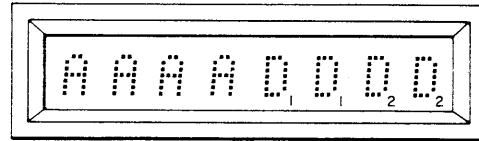

An error during the address test is shown.

- A¹A¹A¹A¹ = Correct address.
- A²A²A²A² = Incorrect address.

Depressing ENTER will continue the RAM Buffer Test, displaying "B DD AAA".

Depressing CLEAR will terminate this test and return the M980 to the Self-Test Selection.



2411 Garden Road
Monterey, California 93940
Telephone (408) 372-4593
TWX: 910-360-7082