

## Agilent ParBERT 81250 Parallel Bit Error Ratio Tester

Product Overview  
Version 5.66



The only  
Parallel Bit Error Ratio  
Solution for Testing at:

- 675 Mb/s
- 1.65 Gb/s
- 2.7 Gb/s
- 3.35 Gb/s
- 7 Gb/s
- 10.8 Gb/s
- 13.5 Gb/s
- 45 Gb/s

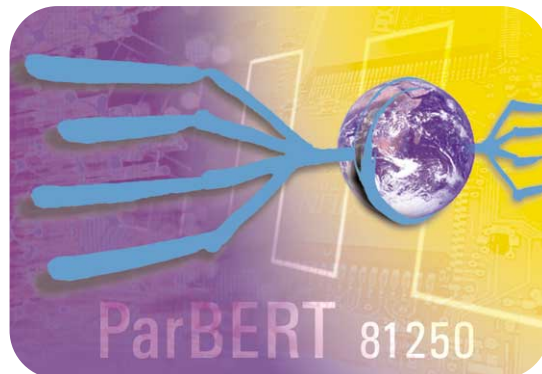

# Table of Contents

<b>Section</b>		<b>Beginning on Page</b>
Agilent ParBERT 81250	Overview	3
Agilent ParBERT 81250	Product Family	4
Agilent ParBERT 81250	Key Features & Benefits	5
Agilent ParBERT 81250	Measurement Software	9
Agilent ParBERT 81250	Application Examples	15
Agilent ParBERT N4872A	13.5 Gb/s Generator	18
Agilent ParBERT N4873A	13.5 Gb/s Analyzer	
Agilent ParBERT E4866A	10.8 Gb/s Generator Module	23
Agilent ParBERT N4868A	Booster Module	
Agilent ParBERT E4867A	10.8 Gb/s Analyzer Module	
Agilent ParBERT N4874A	7 Gb/s Generator	27
Agilent ParBERT N4875A	7 Gb/s Analyzer	
Agilent ParBERT E4861B	3.35 Gb/s Data Module	32
Agilent ParBERT E4862B	3.35 Gb/s Generator Front-End	
Agilent ParBERT E4863B	3.35 Gb/s Analyzer Front-End	
Agilent ParBERT 81250	Typical Waveform Pictures	36
Agilent ParBERT E4861A	2.7 Gb/s / 1.65 Gb/s Data Module	37
Agilent ParBERT E4862A	2.7 Gb/s Generator Front-End	
Agilent ParBERT E4863A	2.7 Gb/s Analyzer Front-End	
Agilent ParBERT E4864A	1.65 Gb/s Generator Front	
Agilent ParBERT E4865A	1.65 Gb/s Analyzer Front	
Agilent ParBERT E4832A	675 Mb/s Data Module	40
Agilent ParBERT E4838A	675 Mb/s Generator Front-End	
Agilent ParBERT E4835A	675 Mb/s Analyzer Front-End	
Agilent ParBERT E4809A	13.5 GHz Central Clock Module	44
Agilent ParBERT E4808A	High Performance Central Clock Module	
Agilent ParBERT E4805B	675 MHz Central Clock Module	
General Characteristics		50
PowerRequirements	Modules and Front-ends	51
Quick Ordering Guide	Overview	53
Agilent ParBERT 81250	Product Structure	56
Storage of Customer Specific Data in Agilent ParBERT 81250		58
Related Literature		60

# Agilent ParBERT 81250 Overview

**Agilent ParBERT 81250 is a modular parallel electrical and optical bit error ratio (BER) test platform, which works up to 45 Gb/s. The ParBERT 81250 platform comprises modules that work at 675 Mb/s, 1.65 Gb/s, 2.7 Gb/s, 3.35 Gb/s, 7 Gb/s, 10.8 Gb/s, 13.5 Gb/s and 45 Gb/s. The system generates pseudo random word sequences (PRWS), standard pseudo random binary sequences (PRBS) and user-defined patterns on parallel lines. You can analyze bit error ratios with user defined patterns, PRBS/PRWS or mixed data (a combination of userdefined patterns and PRBS).**

ParBERT 81250 is a perfect fit for parallel-to-serial, serial-to-parallel, serial-to-serial and multiple serial BER test. Examples are multiplexer and demultiplexer (Mux/Demux) - or SerDes (serializer/deserializer) - testing used in telecom and storage area network (SAN) ICs, multiple transmitter and receiver testing in manufacturing, amplifiers as well as 10GbE and forward error correction (FEC) device testing.

It is also an ideal extension for the high-speed channels of an IC-tester.

ParBERT 81250 also provides data and control signals for the DUT if required.

**The ParBERT software suite is a ready-to-use package, which offers different levels of measurement analysis:**

1. Fast pass/fail measurements ideal for production
2. Output timing measurements provide results for setup & hold times, skew between channels, phase margins, detailed jitter results (RJ/DJ/TJ), and eye opening specification results
3. Output level measurements provide results for high/low levels, amplitudes, threshold margins and Q-factor analysis
4. Graphical results for detailed root cause analysis - see trends clearly and fast, e.g. color and contour plots.
5. "Fast Eye" mask measurement.
6. Comprehensive "Jitter" measurement applications, e.g spectral decomposition of jitter.
7. "Eye Opening" measurement applications

**Agilent ParBERT 81250 is particularly suitable for the following applications:**

1. 10GbE device testing
2. Multiplexer and demultiplexer testing
  - OC-768 device testing: You can test 16:1 and 4:1 40G devices using the ParBERT 81250 45G and either 3.3 Gb/s or 10.8 Gb/s modules
  - OC-192 device testing: the ParBERT 81250 10.8 Gb/s modules enable testing of the serial high-speed side of Muxes/DeMuxes. Combined with 675 Mb/s, 1.6 Gb/s, 2.7 Gb/s or 3.3 Gb/s modules you can test both sides of multiplexers/demultiplexers
  - OC-48 device testing
3. Characterization of SAN ICs
4. Manufacturing test of multiple transmitters, receivers, transceivers and amplifiers
5. FEC device test

**For more information on these applications, please see product number for related literature mentioned on the back page. This document focuses on the ParBERT platform.**

# The Ideal Solution for High-Speed Parallel Bit-Error-Ratio (BER) Tests



Selection guide for ParBERT 81250 platform generator, analyzer, front-ends and modules

<b>Data rate range</b>	333.334 kb/s – 675 Mb/s (1)	333.334 Mb/s – 1.65 Gb/s	333.334 Mb/s – 2.7 Gb/s	20,834 MHz – 3.35 Mb/s (1)	620 Mb/s – 7 Gb/s	620 Mb/s – 13.5 Gb/s
<b>Technology addressed</b>	TTL, PECL, LVDS	CML, PECL,ECL, LVDS,SSTL-2	CML, PECL,ECL, LVDS,SSTL-2	CML, PECL,ECL, LVDS,SSTL-2	LVDS, CML, PECL, ECL, CMOS	LVDS, CML, PECL, ECL,CMOS
<b>Memory depth expected &amp; acquisition</b>	PRBS/PRWS/ 2 Mb memory	PRBS/PRWS/ 8 Mb memory	PRBS/PRWS/ 8 Mb memory	PRBS/PRWS/ 16 Mb memory	PRBS/PRWS/ 64 Mb memory	PRBS/PRWS/ 64 Mb memory
<b>Generator</b>	Front-end E4838A	Front-end E4864A	Front-end E4862A	Front-end E4862B	Modules N4874A	Modules N4872A
<b>Transition times (20% - 80%)</b>	0.5 to 4.5 ns– (10% 90%) var.	90 ps typ	90 ps typ	< 75 ps	< 20 ps	< 20 ps
<b>Amplitude/ resolution</b>	0.1 – 3.5 Vpp 10 mV	0.05 – 1.8 Vpp 10 mV	0.05 – 1.8 Vpp 10 mV	0.05 – 1.8 Vpp 10 mV	0.1 – 1.8 Vpp 5 mV	0.1 – 1.8 Vpp 5 mV
<b>Window</b>	-2.2 to +4.4 V	-2.0 to +3.0 V	-2.0 to +3.0 V	-2.0 to +3.5 V	-2.0 to +3.0 V	-2.0 to +3.0 V
<b>Analyzer</b>	Front-end E4835A	Front-end E4865A	Front-end E4863A	Front-end E4863B	Module N4875A	Module N4873A
<b>Maximum input voltage range</b>	0 to +5 V -2 to +3 V	-2 V to +1 V -1 V to +2 V 0 V to 3 V	-2 V to +1 V -1 V to +2 V 0 V to 3 V	-2 V to +1 V -1 V to +2 V 0 V to 3 V	-2 V to +3 2 V window	-2 V to +3 2 V window
<b>Input sensitivity</b>	50 mV typ diff	50 mV typ	50 mV typ	< 50 mV	< 50 mV	< 50 mV
<b>Delay resolution</b>	2 ps	1 ps	1 ps	1 ps	100 fs	100 fs
<b>Data module</b>	E4832A	E4861A	E4861A	E4861B	–	–
<b>CentralClk</b>	Slots / frame	Slots / frame	Slots / frame	Slots / frame	Slots / frame	Slots / frame
<b>E4805B/8A/9A</b>	11/11/10	11/11/–	11/11/–	–/11/10	–/–/10	–/–/10
<b>Channels/slot</b>	4	2	2	2	1	1
<b>Channels/frame</b>	44	22	22	22	10	10
<b>Base VXI frame +</b>	\$37,000.00	\$37,000.00	\$37,000.00	\$44,000.00	\$52,000.00	\$52,000.00
<b>Generator/channel</b>	\$3,100.00	\$7,300.00	\$9,100.00	\$13,300.00	\$38,300.00	\$56,100.00
<b>Analyzer/channel</b>	\$4,500.00	\$8,500.00	\$10,900.00	\$16,000.00	\$38,300.00	\$56,100.00

[1] RZ support

## Modules

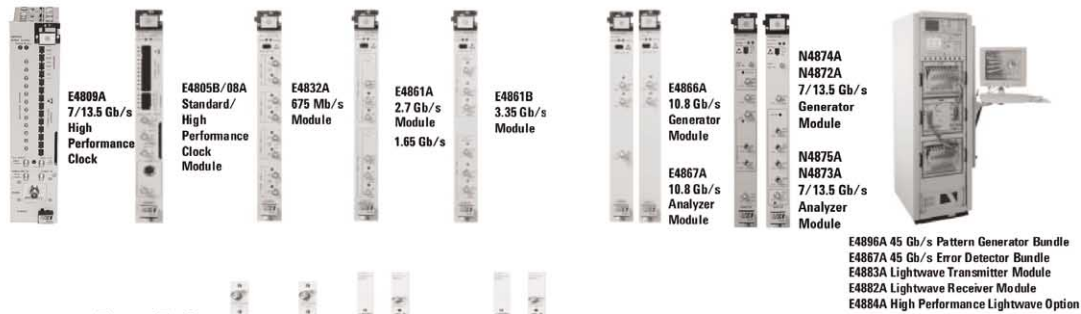

## Front Ends

**E4838A** 675 Mb/s Generator  
**E4835A** 675 Mb/s Analyzer  
**E4862A/64A/63A/65A** 2.7/1.6 Gb/s Generator/Analyzer  
**E4862B/63B** 3.35 Gb/s Generator/Analyzer

675 Mb/s    2.7/1.6 Gb/s    3.35 Gb/s    10.8 Gb/s    7/13.5 Gb/s    45 Gb/s

Figure 1. ParBERT product family

# ParBERT 81250 key features & benefits

**Table 1. Features and benefits**

Features	Benefits
Modular, flexible and scalable platform architecture <ul style="list-style-type: none"> <li>• Up to 128 channels @ 675 Mb/s</li> <li>• Up to 64 channels @ 3.35 Gb/s, 2.7 Gb/s</li> <li>• Up to 30 channels @13.5 Gb/s, 10.8 Gb/s, 7 Gb/s</li> </ul>	<ul style="list-style-type: none"> <li>• Grows with customer's test and application needs</li> <li>• Covers a wide range of technologies and applications</li> </ul>
Generator and analyzer modules available from 675 Mb/s up to 45 Gb/s	Allows system configurations perfectly meeting customer's application needs
Mix of channels (generator/analyzer) and speed classes	Provides unique flexibility to test complex devices with many channels and/or frequencies, e.g., serial bus applications, Mux/Demux (SerDes), FEC
Generate pseudo random word sequences (PRWS) and standard PRBS up to $2^{31}-1$ ; analyze bit error ratios with user- defined data, PRBS or mixed data from parallel ports	Perform parallel BER measurements - ideal for Mux/Demux applications
Generate and analyze single-ended and differential signals - including true differential	<ul style="list-style-type: none"> <li>• Test logic technologies e.g. LVDS, ECL, PECL, SSTL-2</li> <li>• Generate the necessary signals to perform margin tests, emulate frequency and level changes and stress your device as far as possible</li> </ul>
Data generation and analysis with sequencing and looping	<ul style="list-style-type: none"> <li>• Generate complex sequences that contain memory-based (up to 64 Mbit) and/or PRBS/PRWS data</li> <li>• Generate data packets with header and payload</li> <li>• React to control signals from the DUT</li> </ul>
Auto phase & auto delay alignment	<ul style="list-style-type: none"> <li>• Auto alignment of expected data with incoming data</li> <li>• Save time as you do not need to find the correct sample point manually - typically takes just 100 ms</li> </ul>
Each generator or analyzer channel has independent programmable control of voltage levels and timing delay	Allows device characterization for a wide range of technologies/applications in the semiconductor and communication industry
Interrupt-free change of analyzer delay/generator delay (13.5 Gb/s, 7 Gb/s and 3.35 Gb/s; other speed classes generator only)	Continuous running signals for measurements where changing analyzer/generator delay is necessary
Jitter modulation (13.5 Gb/s, 7 Gb/s and 3.35 Gb/s)	Allows jitter tolerance testing to be performed
Variable cross (13.5 Gb/s, 7 Gb/s and 3.35 Gb/s)	Provides real-world stress
Windows XP®/Windows 2000® operating systems	Popular industry standard operating system
Plug and play drivers	Allows remote access and simplifies remote program development
Measurement suite	<ul style="list-style-type: none"> <li>• DUT output timing measurement - bathtub curve with jitter analysis (RJ/DJ separation), skew between channels, setup and hold times</li> <li>• Output level measurement - amplitude information, high/low level and Q-factor</li> <li>• Eye opening measurement - color and contour plots</li> <li>• Fast eye mask measurement - automatic threshold adjust, fast and efficient insights for manufacturing test</li> <li>• Comprehensive BER measurement - actual and accumulated BER, errors of ones and zeros, total bits transferred and file capturing for post-processing analysis.</li> <li>• Spectral jitter</li> </ul>

# Key features

## Perform parallel BER measurements up to 13.5 Gb/s

ParBERT 81250 makes testing of Mux/Demux (serializer/deserializer) devices easier. Only ParBERT 81250 is able to generate pseudo-random-word sequences (PRWS) on the parallel side and analyze bit-error ratios with user-defined patterns, PRBS up to  $2^{31} - 1$  or both combined.

## PRBS/PRWS and memory capability

The polynomial  $2^n - 1$ , the PRBS algorithm and the parallel bus width define PRWS. The bits of the PRWS are assigned to parallel lines and are then multiplexed to form a PRBS (see Figure 3).

## Auto phase and auto delay alignment

As the latency from the input to the output is often not known exactly, or it is not deterministic, synchronization between incoming data and outgoing data has to be carried out. ParBERT 81250 has three capabilities to synchronize/align the incoming data automatically (see Figures 4 and 5):

- 1) Data shift bit-by-bit if PRBS is used
- 2) Detect word if user-defined patterns are used
- 3) Moving of the sampling point delay of the analyzer up to 10 ns without stopping the instrument. Moving of the sampling point delay can also be used in addition to the alignment of data patterns (1 and 2) to refine the synchronization.

Port/Measurement	Percent	Actual BER	Actual Compared ...	Actual # of Errors	Accumulative BER	Accumulative Compared Bits	Accumulative # of Errors	Actual 0 BER	Actual 1 BER	Actual # of 0 Errors	Actual # of 1 Errors
[2] Data0	5%	2.500E-001	1.040E+000	2.620E+008	1.244E-001	1.474E+010	1.834E+000	2.500E-001	2.500E-001	0.000E+000	2.600E+008
[2] Data1	5%	4.000E-001	5.200E+008	2.620E+008	> 502E-001	7.329E+009	1.834E+009	5.000E-001	5.000E-001	0.000E+000	2.600E+008
[2] Data0	5%	0.000E+000	5.200E+000	0.000E+000	0.000E+000	7.409E+009	0.000E+000	0.000E+000	0.000E+000	0.000E+000	0.000E+000
[2] Data	5%	0.000E+000	2.080E+009	0.000E+000	0.000E+000	2.908E+010	0.000E+000	0.000E+000	0.000E+000	0.000E+000	0.000E+000
[5] Data5	5%	0.000E+000	5.200E+008	0.000E+000	0.000E+000	7.452E+009	0.000E+000	0.000E+000	0.000E+000	0.000E+000	0.000E+000
[3-2] Data2	5%	0.000E+000	8.300E+008	0.000E+000	0.000E+000	7.189E+009	0.000E+000	0.000E+000	0.000E+000	0.000E+000	0.000E+000
[3-3] Data0	5%	0.000E+000	5.100E+008	0.000E+000	0.000E+000	7.832E+009	0.000E+000	0.000E+000	0.000E+000	0.000E+000	0.000E+000
[3-4] Data1	5%	0.000E+000	5.100E+008	0.000E+000	0.000E+000	7.899E+009	0.000E+000	0.000E+000	0.000E+000	0.000E+000	0.000E+000

Figure 2. BER results screen

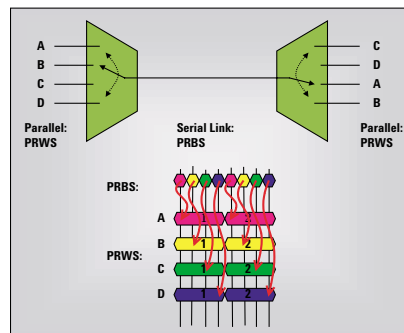

Figure 3. MUX/DEMUX application: relationship between PRBS and PRWS

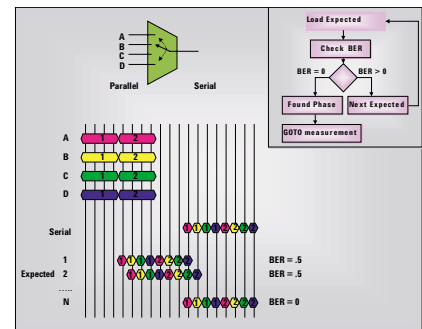

Figure 4. Mechanism of auto-phase and auto-delay assignment

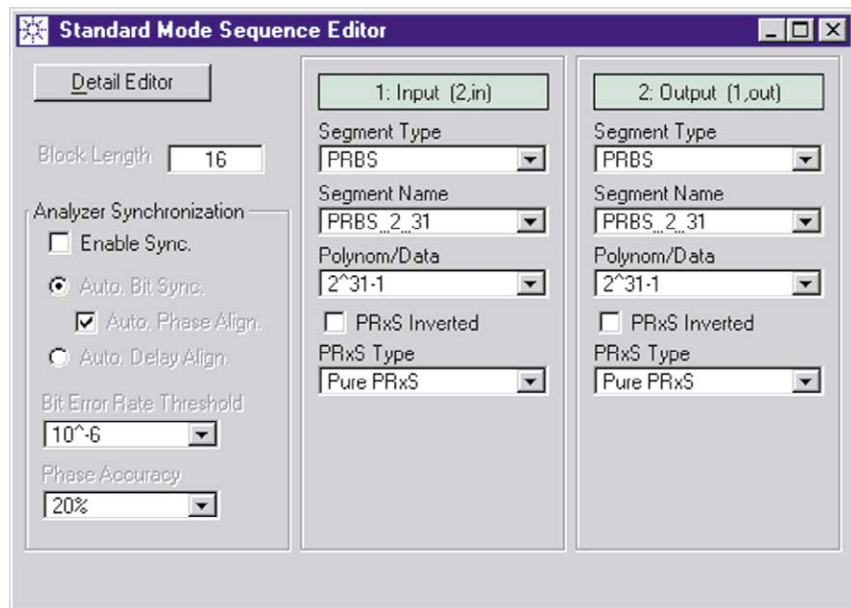
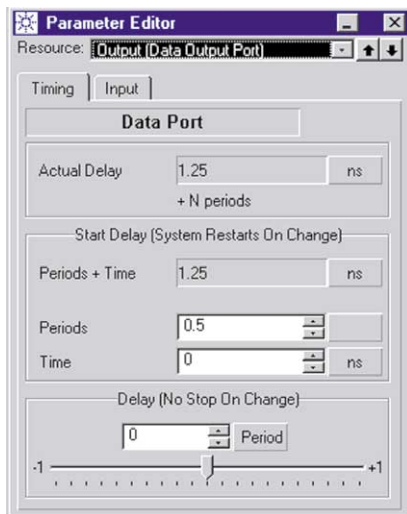

Figure 5. Standard view when choosing PRBS/PRWS patterns and data synchronization mode

## Interrupt-free change of analyzer delay

The analyzer delay can be changed  $\pm 1$  period while the instrument is running without causing it to stop (see Figure 6).

The 13.5 Gb/s, 7 Gb/s and 3.35 Gb/s modules can do this on both the analyzer and generator.

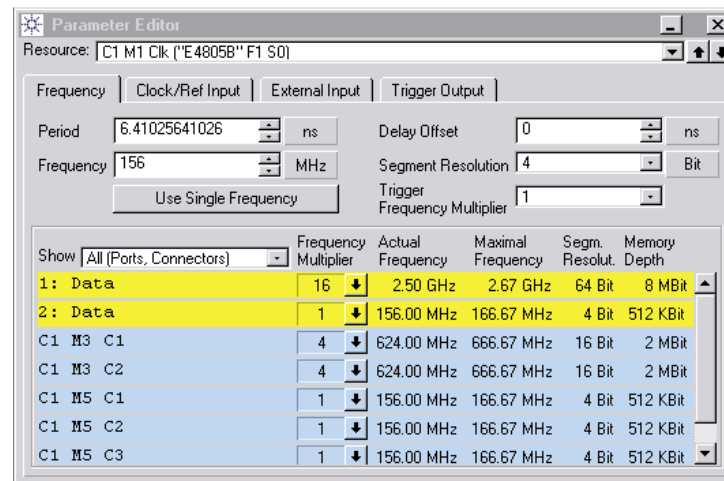

**Figure 6. Parameter editor for analyzer timing**

With the two clock groups any frequency ratio  $m/n$ ,  $n = 1, 2, \dots, 256$  is possible. The 'application examples' show some 'two-clock system' configurations.

## Multiple frequencies

The modular architecture of ParBERT allows the use of different channels at different speeds. Therefore it is possible to combine channels of different speed classes in one ParBERT system. A ParBERT system can be configured with one or more clock groups. Each clock group is controlled from one clock module. Within one clock group (one clock module controls a group of channels) a frequency ratio of  $2^n$ ,  $n = 1, 2, \dots, 10$  is possible, see Figure 7.



**Figure 7. Parameter editor for setting multiple frequencies in one system**

## Platform description

The fundamental idea of the ParBERT 81250 product structure is to offer an instrument, which meets your measurement needs exactly. The ParBERT modularity includes modules and front-ends. At 13.5 Gb/s, 10.8 Gb/s and 7 Gb/s, there are dedicated modules for generators and analyzers. At 3.35 Gb/s, 2.7 Gb/s, 1.6 Gb/s and 675 Mb/s the modules carry 2/4 front-ends.

**Front-ends** determine the speed and input/output capabilities of your instrument. A mix of front-ends is possible within the modules. The front-ends are placed in **data modules**, which are responsible for sequencing, generating and analysing of data patterns including PRBS/PRWS. These modules, plus at least one **clock module**, which generates the common system frequency of the instrument, are installed in the mainframe.

The VXI frame offers 13 slots. Assuming the use of the FireWire interface and one clock module in place, the mainframe can hold up to 10 channels at 13.5 Gb/s and 7 Gb/s, 11 channels at the data rate of 10.8 Gb/s, 22 channels at 3.35 Gb/s, 2.7 Gb/s and 1.65 Gb/s or 44 channels at 675 Mb/s. If more channels are needed there is the possibility of adding up to two expander frames to reach the maximum number of channels within one clock group. Additional clock modules are needed to set up systems which work with different clock speeds that are not divisible or multipliable by the factors 2, 4, 8, 16 (if E4832A is used) and 2 and 4 (if E4861A is used). For example, for testing 1:7 or 1:10 Mux/ Demux devices two clock modules are required. Please check the application examples within the next chapter. The **ParBERT 81250 software suite** runs on an external PC, or a laptop, which is connected to the system via an IEEE 1394 PC link to VXI.

The operating system is MS Windows® 2000 or XP.

The ParBERT 81250 software suite consists of:

- Graphical user interface
- Measurement suite
- Software tools (10GbE tool, SONET/SDH frame generator
- VXI *Plug&Play* driver

At runtime the software consists of several processes. The firmware server controls the hardware and is the link between the graphical user interface and the hardware modules. The measurement software or any custom remote program can communicate with the firmware server. Remote access is established either by using the *Plug&Play* drivers from Agilent VEE Pro or from a C/C++/Visual Basic program or by a SCPI based language via GPIB. This allows the building of a customized VXI system including other standard VXI modules.

**Table 2**

	675 Mb/s	1.65 Gb/s 2.7 Gb/s, 3.35 Gb/s	10.8 Gb/s	13.5 Gb/s, 7 Gb/s
Data rate range	333.3 Kb/s .. 675 Mb/s	333.4 Mb/s .. 2.7 Gb/s 20.8 Mb/s .. 3.35 Gb/s	9.5 .. 10.8 Gb/s	620 Mb/s .. 7 Gb/s 620 Mb/s .. 13.5 Gb/s
Number of channels within 1 frame/+ 2 expander frames with ext. PC inputs/outputs	44/132 differential & single ended	22/66 differential & single ended	11/33 differential & single ended	10/30 differential & single ended
Data capability	PRBS/PRWS/ 2 MB memory	PRBS/PRWS/ 8/16 MB memory	PRBS/PRWS/ 32 MB memory	PRBS/PRWS/ 64 bit memory
Generator formats	DNRZ, RZ, R1	2.7G:DNRZ 50% clock DNRZ, R1, RZ	DNRZ, separate clock output	NRZ, DNRZ
Technology addressed	TTL, (P)ECL, LVDS	CML, (P)ECL, LVDS, SSTL-2	CML, ECL, LVDS, SSTL-2	LVDS, CML, PECL, ECL, low voltage CMOS



# ParBERT 81250 measurement software

The ParBERT measurement software includes the following measurements:

1. BER measurement
2. Fast eye mask measurement
3. DUT output timing measurement
4. Spectral decomposition of jitter
5. DUT output level measurement
6. Eye opening

The ParBERT 81250 measurement software is a ready-to-use measurement user interface, which aids you with the verification and characterization of high-speed digital components and modules.

The measurement software offers three different levels of measurement analysis:

1. Fast pass/fail measurements ideal for production.

If you work in production you can test against limits, e.g., the BER is set at a given threshold. The fast pass/fail measurements allow you to test devices at up to ten times faster than with previous test methods - it typically takes less than one second!

2. Fast clock out to data out (setup and hold times), skew and eye opening specification results - no need to calculate values

3. Graphical results for detailed root cause analysis - see trends clearly and fast, e.g., pseudo color plot and contour plots.

If you are in R&D you can characterize your device under test (DUT), find the limits and specifications of the DUT and results can be viewed graphically. With its easy-to-use Windows XP or Windows 2000 based GUI and graphical results, it simplifies test development

Table 3

General	
Store/recall	Workspace Single measurements
Copy/paste	Measurement data to compare between measurements
Print	Various print-out functions
Export of measurement data	ASCII
Online help	Extensive applications
Remote interface	P&P driver, Ready to use active X components to integrate complete measurements in VEE, Visual C++, VB, C#, Labview, Matlab and Excel

and allows easy test execution. Data can be exported and the graphical and numerical results printed.

You can create a test executive around the measurement software using Agilent VEE Pro, National Instruments' LabVIEW, Excel, Agilent TestExec, C/C++, C# and Microsoft VisualBasic.

The measurement software is included in the standard software package which comes with each ParBERT 81250 system.

## BER measurement

The bit error ratio measurement measures the total number of bits transferred and the number of errored bits, bits which don't meet the decision threshold. You can now view the actual 0 and 1 BER, actual 0 and 1 errors, accumulative 0

and 1 BER and accumulative 1 and 0 errors at once.

Measurement results provided:

- Displayed errored ones and zeros at the same time
- Log file
- Resynchronization
- Pass/fail results

The bit error ratio measurement can be run as a single shot or repeatedly. Several run and error counting options and stop criteria can be defined. Repetitive mode offers automatic resynchronization. It is the ideal mode for characterizing your device. In R&D, for example, you can change the temperature and measure how it affects the BER. Single mode is particularly useful for manufacturing as you can stop the measurement after a specified number of errors and/or seconds.

Table 4. BER measurement

Measurement parameters	BER Compared bits Errors from expected 0s Errors from expected 1s Total errors Parameters from last measurement period Accumulated parameters
Measurement mode	Single or repetitive Repetition rate is programmable in seconds (In this mode resynchronization can be enabled)
Pass/fail	For actual and accumulated parameters
Log file	Logs all measured parameters

## Fast eye mask

The fast eye mask measurement is ideal for use in manufacturing as a measurement typically takes just one second (including synchronization). This measurement records the BER of a predefined number of points (1 to 32), not the whole eye, defined by a threshold and timing value relative to the starting point of the measurement. You enter the pass/fail criteria of the measurement and the BER threshold, find the middle point of the eye with the sequence and then run the BER. For example, you can define a threshold and the ParBERT will find the optimal sample point and the high and low levels automatically, e.g, 20% and 80%.

Measurement results provided:

- BER at predefined sample points
- pass/fail results

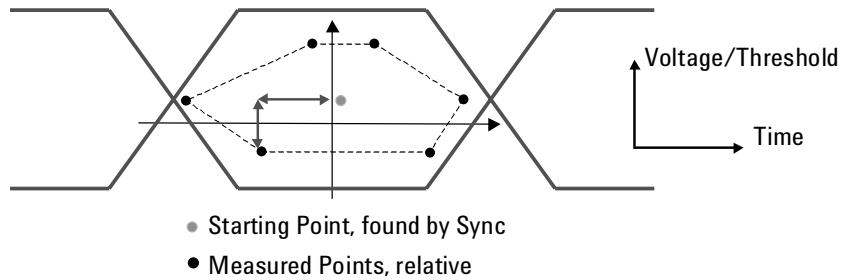

Figure 8. How the fast eye mask measurement works

Port/Terminal	Copied	1	2	3	4	5	6	7	8
Measurement									
Relative Time	X	0.400 UI	0.400 UI	0.160 UI	0.160 UI	0.160 UI	0.160 UI	0.160 UI	0.160 UI
Voltage(abs)	X	0.000 V	0.000 V	200.000 mV	200.000 mV	200.000 mV	200.000 mV	200.000 mV	200.000 mV
[1] ClockPort									
[1-1] Clk0		0.000	0.000	0.000	0.000	0.000	0.000	0.000	0.000
[3] DataPort									
[3-1] Data0		0.000	0.000	0.000	0.000	0.000	0.000	0.000	0.000
[3-2] Data1		0.000	0.000	0.000	0.000	0.000	0.000	0.000	0.000
[3-3] Data2		0.000	0.000	0.000	0.000	0.000	0.000	0.000	0.000
[3-4] Data3		0.000	0.000	0.000	0.000	0.000	0.000	0.000	0.000
Copied 07/16/01 16:39:11	X								
Relative Time	X	-0.400 UI	0.400 UI	-0.160 UI	0.160 UI	-0.160 UI	0.160 UI	-0.160 UI	0.160 UI
Voltage(abs)	X	0.000 V	0.000 V	200.000 mV	200.000 mV	-200.000 mV	-200.000 mV	200.000 mV	200.000 mV
[1] ClockPort (Copied)	X								
[1-1] Clk0 (Copied)	X	0.000	0.000	0.000	0.000	0.000	0.000	0.000	0.000
[3] DataPort (Copied)	X								
[3-1] Data0 (Copied)	X	0.000	0.000	0.000	0.000	0.000	0.000	0.000	0.000
[3-2] Data1 (Copied)	X	0.000	0.000	0.000	0.000	0.000	0.000	0.000	0.000
[3-3] Data2 (Copied)	X	0.000	0.000	0.000	0.000	0.000	0.000	0.000	0.000
[3-4] Data3 (Copied)	X	0.000	0.000	0.000	0.000	0.000	0.000	0.000	0.000

Figure 9. The fast eye mask setup and results window

Table 5. Fast eye mask measurement time examples  
(run on a system via IEEE 1394 PC link)

Frequency	# channels	# points measured	Compared bits	Time taken
2.7 Gbit/s	2	6	106	< 1 sec
2.7 Gbit/s	2	32	106	~ 1 sec
675 MHz	16	6	106	~ 6 sec
675 MHz	16	32	106	~ 6 sec

# DUT output timing measurement

This measurement measures the BER of a DUT's output versus sample point delay, which is shown graphically as a bathtub curve. The delay is always centered to the optimum sampling delay point of the port (terminals). If a clock is defined the clock to data alignment is measured. If the absolute delay can be measured it will also be displayed. Relative timing, where edges are compared, is also possible.

Measurement results provided:

- Clock out to data out timing relationships (setup/hold time)
- Skew between outputs
- Delay at optimum sample point
- Phase margin
- Pass/fail results
- Jitter results for total jitter, random jitter and deterministic jitter

There is also a numerical view that shows the “numerical return values” for the selected BER threshold only.

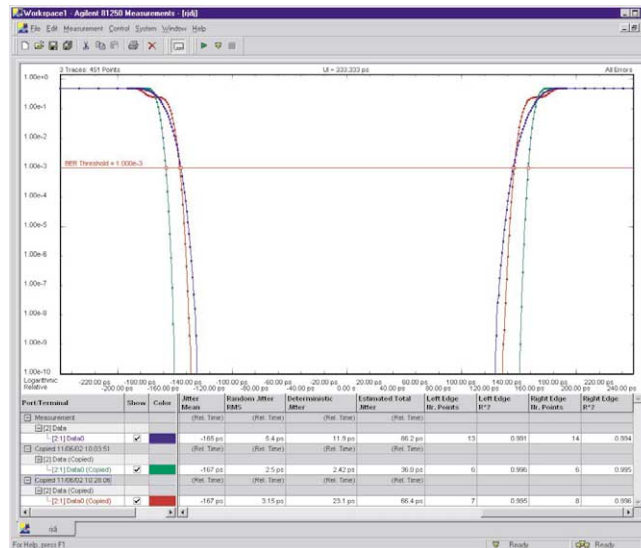

Figure 10a. View the DUT output measurement results as a bathtub curve

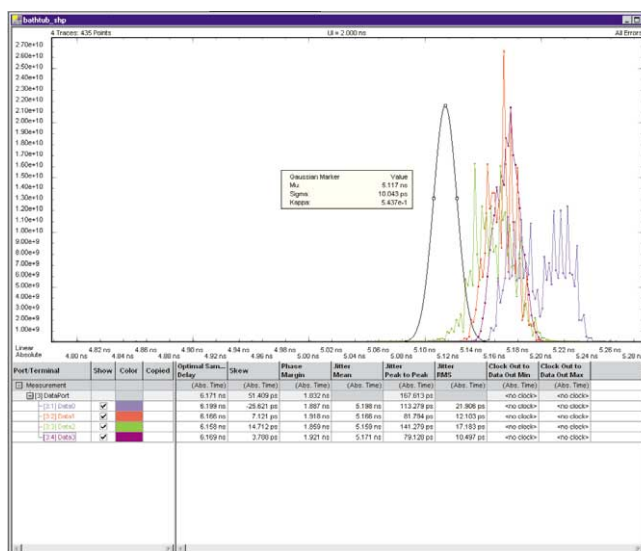

Figure 10b. Jitter can be directly equated from the bathtub curve. View the jitter as a histogram

Table 6. DUT output timing measurement

Timing parameters	Optimum sample point delay Phase margin Clock to data out minimum Clock to data out maximum Skew between channels
Jitter parameters	RMS jitter Mean value Peak peak jitter for specific BER
Pass/fail	For all timing and jitter parameters Each parameter can be individually enabled
Graph	View of BER versus sample delay 2 Markers: delay, BER

# Spectral decomposition of jitter

This measurement provides a technique for the spectral decomposition of jitter components, which helps debugging as well as design verification and characterization of devices. This measurement uses the RJ/DJ Separation provided by the output timing measurement.

The decomposition technique allows inband and outband characterization of circuits and devices including PLLs and CDRs.

While debugging designs, the new measurement allows the thorough exploration of the various components of deterministic jitter, helping to separate even the smallest amounts of periodic jitter (for example) from the random jitter floor. Measurement results provided:

- Top 10 frequency/power spots
- Total power
- Noise power

**Table 7. Spectral decomposition of jitter**

<b>Parameters</b>	Data segment length FFT windowing
<b>Pass/fail</b>	Power factor
<b>Graphs</b>	Spectrum graph (power vs. frequency)

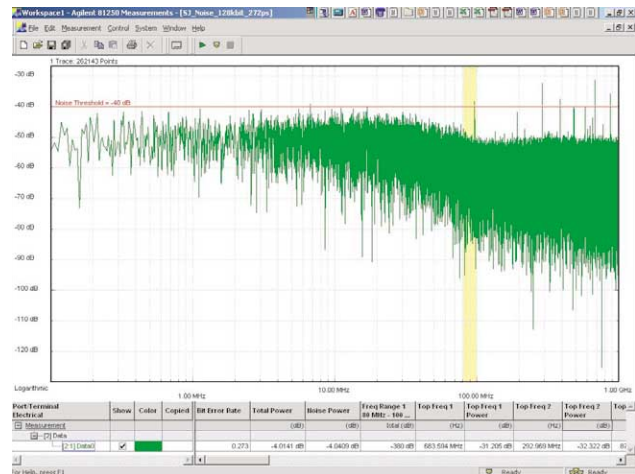
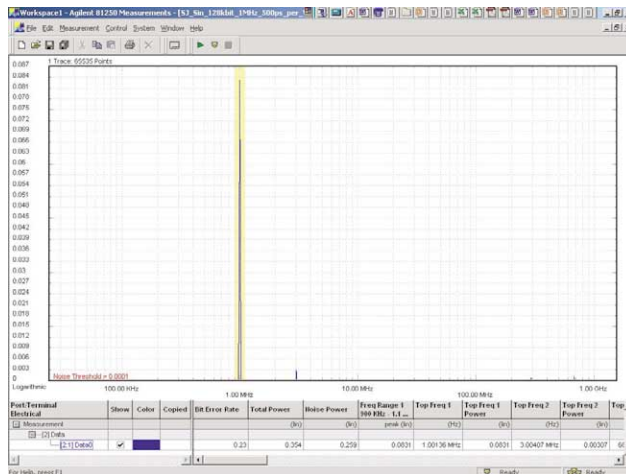

**Figure 11. Spectral decomposition of jitter**

## Output level measurement

This measurement performs a sweep of the analyzer threshold. It is shown graphically as a bathtub curve, with the threshold on the Y-axis and BER on the X-axis (see Figure 12a). From the data a histogram showing BER versus threshold can be derived (Figure 12b) which can be used to calculate one/zero level means and standard deviations. Also a graph showing Q-factor from BER versus threshold (Figure 12c) can be derived, which shows the result of two tail fitting operations for the innermost gaussian distributions in the BER histogram.

**Table 8. Output level measurement**

Measurement parameters	High/low level Mean level Amplitude Threshold margin High/low level standard deviation Peak peak noise Signal/noise ratio (rms & peak-to-peak) Q factor
Pass/fail	For all parameters Each parameter can be individually enabled
Graphs	BER versus threshold BER histogram versus threshold Q from BER versus threshold

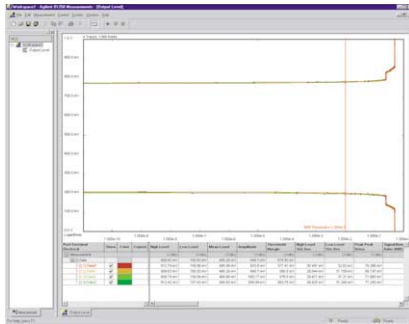

**Figure 12a. BER versus threshold**

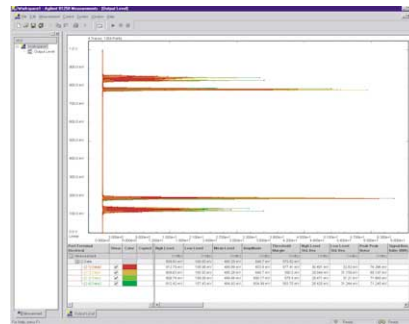

**12b. BER histogram versus threshold**

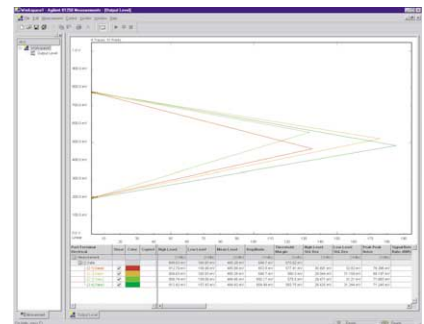

**12c. Q from BER versus threshold**

## Eye opening

To measure the eye opening the sampling delay and the threshold of the receiving channels are swept.

Measurement results provided:

- Eye opening (voltage and timing)
- Optimum sample point

**Table 9. Eye opening**

Measurement parameters	Optimum sample Point delay Optimum threshold Eye opening (Volt) Phase margin
Pass/fail	For all parameters Each parameter can be individually enabled
Graph	Two markers: voltage, delay, BER

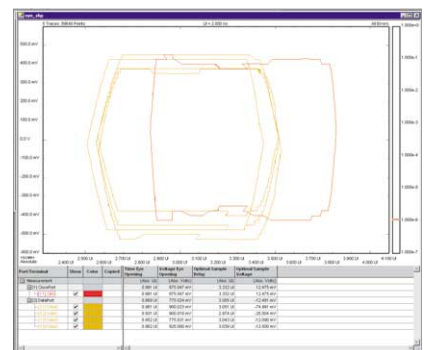
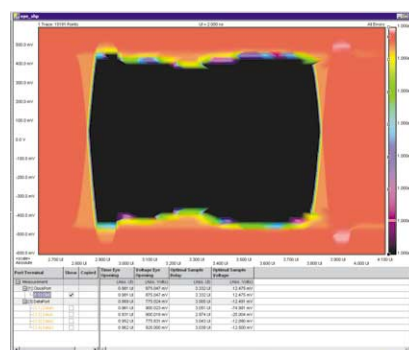
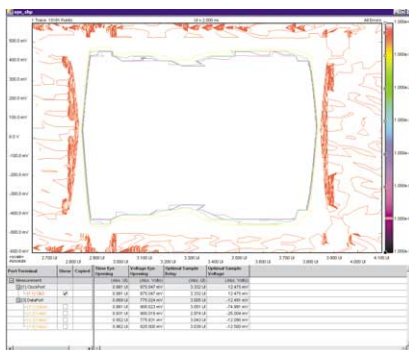

**Figure 13 a/b/c. View the BER for one terminal as a pseudo color plot or contour plot or equal BER at BER threshold**

## The software offers various processing tools

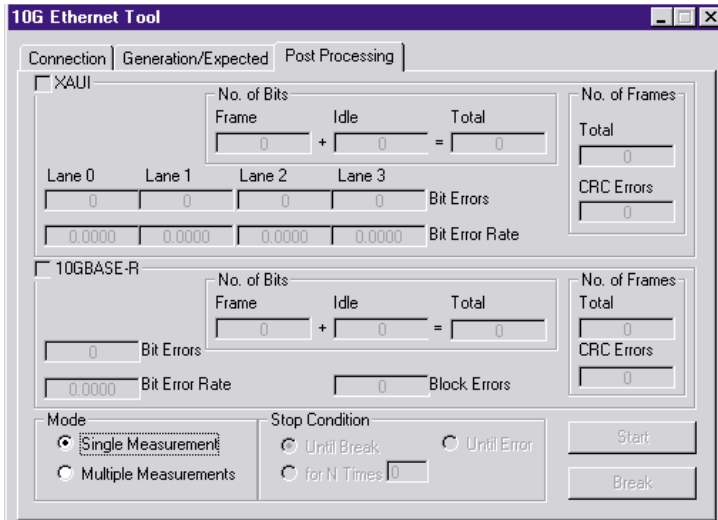

Figure 14a. 10GbE processing tool

Post processing for 10Gb Ethernet applications

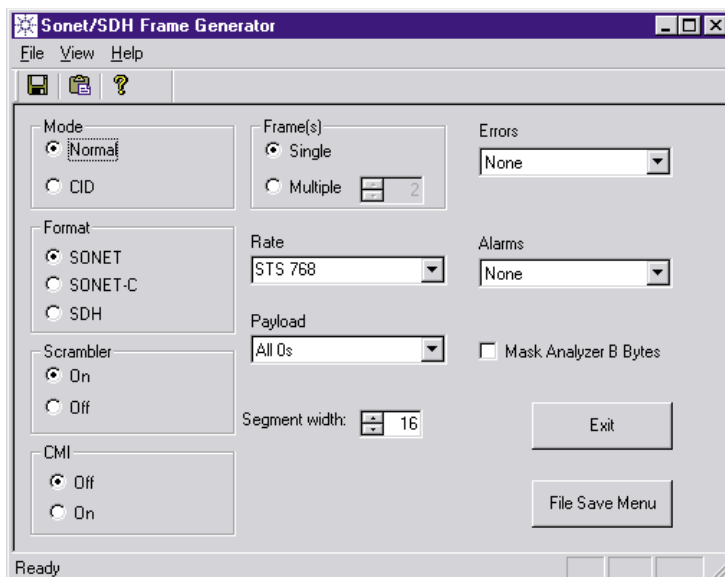

Figure 14b. SONET/SDH editor

SONET/SDH Editor e.g Setup for synchronous architecture Frame Generator applications

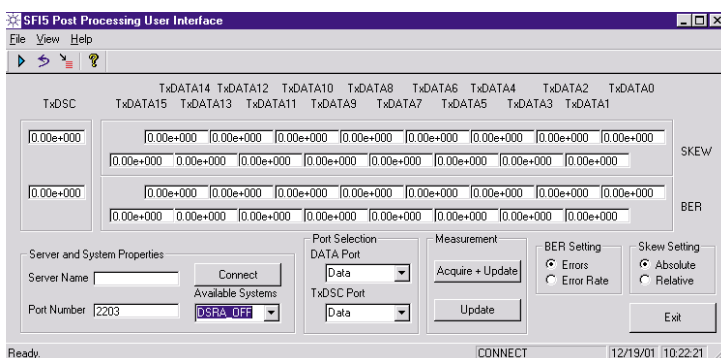

Fig 14c. SFI5 post processing

## Analyzing the data & the DSC (17th) bit

- Ensure that the 16 data channels are valid (valid PRBS  $2^7 - 1$  or  $2^{11} - 1$ ) streams
- Ensure that the 16 data channels are within skew specification
- Ensure that the DSC (17th) bit is valid
  - correct header
  - match to the 16 data channels

# ParBERT 81250 Application examples

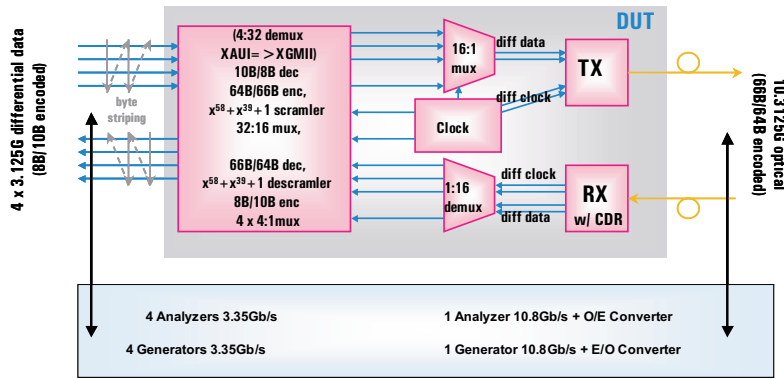

Figure 15a. 10GbE

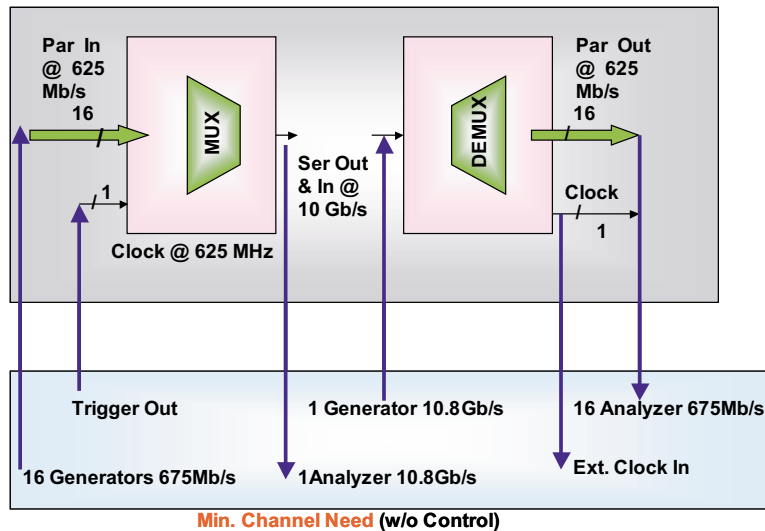

Figure 15b. OC 192 example

## 10GbE

10GbE parts are used in the LAN area. The DUT is a module with 4 x 3.125 Gb/s electrical inputs and outputs each and 1 x 10.3125 Gbit/s optical input and output. The DUT supplies a clock of 156.25 MHz to all systems. The optical signals are converted to electrical.

The configuration of the ParBERT 81250 for 10GbE testing includes four clock groups and E/O and O/E converters for the optical signals at 10.3125 Gb/s.

## OC 192

OC 192 parts are used in telecom applications. Here the DUT consists of two chips, one TX and one RX. There is no clock at the serial side. For testing 16x 675 Mb/s Generators and Analyzers on the parallel side are needed. The serial side needs 1x 13.5 Gb/s or 10.8 Gb/s generator and analyzer.

The 81250 configuration to the left contains all necessary resources to test the Mux/Demux. Both parts of the DUT can be tested at one run-time, regardless of whether memory-based data or PRBS/PRWS are used.

The 13.5 Gb/s or 10.8 Gb/s channels can be used together with the 675 Mb/s channels, as the multiplier is 16 (another multiplier would require separation into 2 clock groups, similar to the other two examples). The combination of all generators and analyzers in individual clock groups eliminates the synchronization limitations.

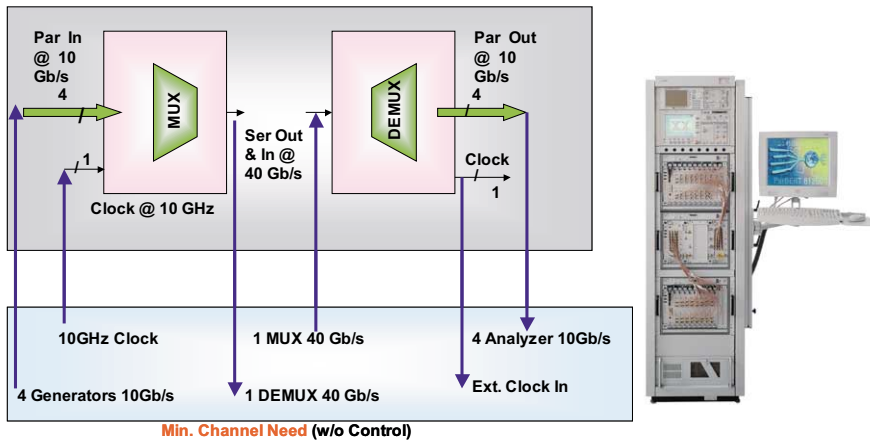

Figure 16a. OC-768 example

### OC 768, 1:4 Mux/DeMux

DUT consists of two chips, one TX one RX. There is no clock at the serial side. This will require 4 x 10.8 Gb/s or 13.5 Gb/s generator and analyzer channels for the parallel side and 1 x 43.2 Gb/s generator and error detector bundle E4894B and E4895B. The 81250 configuration, shown in Figure 16, contains all the necessary resources to test a Mux/Demux. Both parts of the DUT could be tested at once using PRBS/PRWS data.

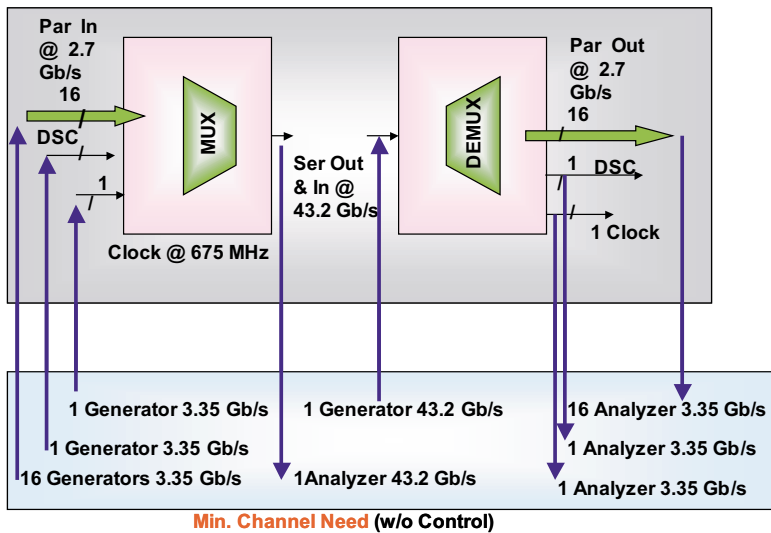

Figure 16b. OC-768 SFI-5 MUX and DeMUX

### OC 768, SFI-5 (1:17) Mux/DeMux

The DUT consists of two parts: a TX and RX part. Characteristic for SFI-5 is the 17th bit, called the DSC signal. This carries specific timing alignment data. The modular ParBERT 81250 architecture allows the easy addition of a 17th generator and analyzer channel to handle the DSC signal. The 81250 configuration, shown in Figure 16a, contains all the necessary resources to test a SFI-5 Mux and Demux. Both parts of the DUT can be tested but not at one run-time. The parallel side (3.35 Gb/s) includes 18 generators and 18 analyzers, so in addition to the 16 data bits, the test system can handle the DSC signal (17th bit) and any clock if necessary.



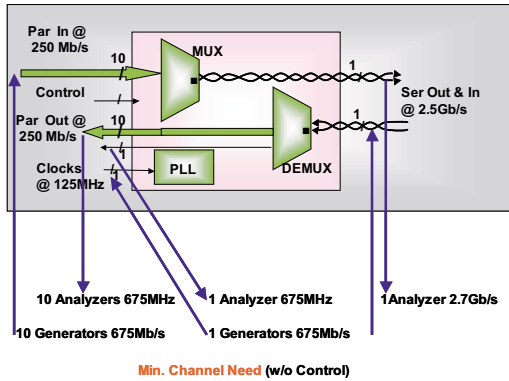

Figure 17a. Gigabit ethernet example

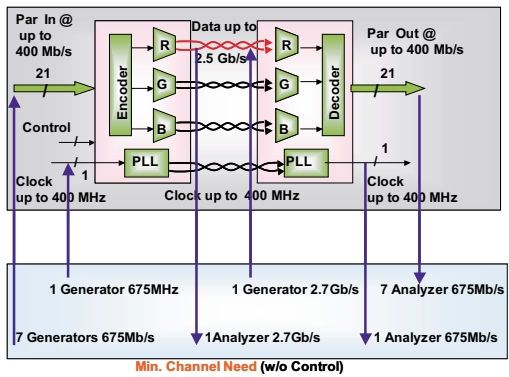

Figure 17b. Video (DVI) example

### Digital video

For transferring data between a CPU and display, a digital video interface was created. The picture shown here is a simple example as there are several implementations created with more or less serial interconnections (up to 8). It is very common that the Mux/Demux ratio is 1:7 with these video interfaces. The DUT consists of two chips, one TX and one RX. Besides 3x serial there is also the clock at the speed of parallel side transferred. For a minimum test of this device, the number of channels needed is counted to stimulate and analyze one of the three Mux/Demux paths.

So this would need a total of 8 x 675 Mb/s generators and analyzers (1x for clock, 7x for data) and 1 x 2.7 Gb/s generator and analyzer for the serial side. The 81250 configuration, shown in Figure 18, contains all necessary resource to test a Mux/Demux. Testing is limited to one serial interface (either R, G or B). As long as PRBS/PRWS data are used both parts of DUT could be tested at one run-time. If memory-based data is used, (due to synchronization limitations) only one part can be tested at one run-time.

### Gigabit ethernet

Gigabit ethernet transceivers take care of physical transceiving data between a PC and a local network. The implementation consists of one chip, containing one TX and one RX. There is no clock at the serial side. (For 10 Gigabit ethernet there would be signals running at 3.125 Gb/s) For testing this device without the control inputs, 11 x 675 Mb/s generator and analyzer channels (1x clock and 10x data) would be needed for the parallel side. On the serial side 1x 2.7 Gb/s generator and analyzer are needed. The 81250 configuration, shown in Figure 17, contains all necessary resources to test this Mux/Demux. As long as PRBS/PRWS data are used, both parts of the DUT can be tested at one run-time. If memory-based data is used, (due to synchronization limitations) only one part can be tested at one run time.

# Agilent ParBERT 81250

## Agilent N4872A ParBERT 13.5 Gb/s Generator Agilent N4873A ParBERT 13.5 Gb/s Analyzer

### Technical Specifications

#### General

The N4872A generator and N4873A analyzer modules are each one VXI slot wide and operate in a range from 620 Mb/s up to 13.5 Gb/s. The ParBERT 13.5 Gb/s modules require the E4809A 13.5 GHz central clock module, which is two VXI slots wide. All specifications, if not otherwise stated, are valid at the end of the recommended N4910A cable set (24" matched pair 2.4 mm).

The N4872A generator module generates hardware-based PRBS up to  $2^{31} - 1$ , PRWS and user-defined patterns and provides a memory depth of 64 Mbit. The N4873A can synchronize on a 48 bit detect word, or on a pure PRBS pattern without detect word.

#### Timing specifications

The ParBERT 13.5 Gb/s modules are able to work with three different clock modes.

- *Internal clock mode:* The common clock mode is provided by the E4809A 13.5 GHz central clock module, which generates clock frequencies up to 13.5 GHz.
- *External clock mode:* The system also works synchronously with an external clock, which is connected to the E4809A clock module.

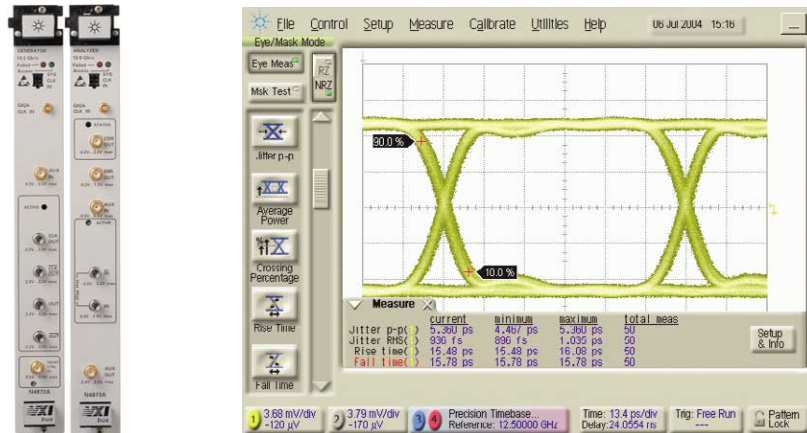

Figure 18. N4872A & N4873A and waveform

Table 10. N4872A data generator timing specifications  
(@ 50% of amplitude, 50 Ω to GND)

<b>Frequency range</b>	620 Mb to 13.500 Gb
<b>Delay = start delay + fine delay</b>	Can be specified as leading edge delay in fraction of bits in each channel
<b>Start delay range</b>	0 to 100 ns
<b>Fine delay range</b>	± 1 period (can be changed without stopping)
<b>Delay resolution</b>	100 fs
<b>Delay accuracy</b>	±10 ps ± 20 ppm relative to the zero-delay placement. (@ 25 °C - 40 °C ambient temp.)
<b>Relative delay accuracy</b>	±2 ps ± 2% typ. (@ 25 °C - 40 °C ambient temp.)
<b>Skew between modules of same type</b>	20 ps after cable deskewing at customer levels and unchanged system frequency. (@ 25 °C - 40 °C ambient temp.)

- *CDR mode:* To use the N4873A 13.5 Gb/s analyzer CDR capabilities, connect the analyzer's CDR out to the E4809A clock module's clock in.

## Sequencing

The sequencer receives instructions from the central sequencer and generates a sequence. The channel sequencer can generate a sequence with up to 60 segments.

An analyzer channel generates feedback signals that can control the channel sequencer and/or the central sequencer. With parallel analyzer channels, the feedback is routed to the central sequencer to allow a common response of all parallel channels. With a single receive channel, the channel sequencer itself handles the feedback signals.

## Pattern generation

The data stream is composed of segments. A segment can be made up of a memory-based pattern, memory-based PRBS or hardware generated PRBS. A total of 64 Mbit (at segment length resolution 512 bits) are available for memory-based pattern and PRBS.

Memory-based PRBS is limited to  $2^{15} - 1$  or shorter. Memory-based PRBS allows special PRBS modes like zero substitution (also known as extended zero run) and variable mark ratio.

A zero substitution pattern extends the longest zero series by a user selectable number of additional zeroes. The next bit following these zero series will be forced to 1. Mark ratio is the ratio of 1 s and 0 s in a PRBS stream, which is 1/2 in a normal PRBS. Variable mark ratio allows values of 1/8, 1/4, 1/2, 3/4 and 7/8.

Due to granularity reasons a PRBS has to be written to RAM several times, at a multiplexing factor of 512 the number of repetitions is also 512. That means that a  $2^{15} - 1$  PRBS uses up to 16 Mbit of the memory. Hardware-based PRBS can be a polynomial up to  $2^{31} - 1$ . No memory is used for hardware-based pattern generation. Error insertion allows inserting single or multiple errors into a data stream. So instead of a 0 a 1 is generated and vice versa.

**Table 11. N4872A pattern and sequencing**

Patterns:	
Memory based	Up to 64 Mbit
PRBS/PRWS	$2^n - 1$ , $n = 7, 10, 11, 15, 23, 31$
Mark density	1/8, 1/4, 1/2, 3/4, 7/8 at $2^n - 1$ , $n = 7, 9, 10, 11, 15$
Errored PRBS/PRWS	$2^n - 1$ , $n = 7, 9, 10, 11, 15$
Extended ones or zeros	$2^n - 1$ , $n = 7, 9, 10, 11, 15$
PRWS port width	1, 2, 4, 8, 16

**Table 12. Data rate range, segment length resolution, available memory for synchronization and fine delay operation**

Data rate range, Mb/s	Segment length resolution	Maximum memory depth, bits
620 ... 1.350,000	32 bits	4.194.304
620 ... 2.700,000	64 bits	8.388.608
620 ... 5.400,000	128 bits	16.777.216
620 ... 10.800,000	256 bits	33.554.432
620 ... 13.500,000	512 bits	67.108.864

## N4872A generator module

The N4872A generates differential or single-ended data and clock signals operating from 620 Mb/s up to 13.5 Gb/s. The output levels are able to drive high-speed devices with interfaces like LVDS, ECL, PECL, CML and low voltage CMOS. The nominal output impedance is 50  $\Omega$  typical. The delay control IN has a single-ended input with 50  $\Omega$  impedance. The input voltage allows modulation of a delay element up to 1 GHz (200 ps) within the generator's differential output. See figure 25c - 26c on page 36.

The AUX IN has a single-ended input with a 50  $\Omega$  impedance. The AUX IN allows injecting gating signals.

An active (TTL high) signal at the auxiliary input forces (gates) the data to a logic zero.

## Data OUT

**Table 13. Parameters for N4872A ParBERT 13.5 Gb/s generator**

<b>Data output</b>	1, differential or single ended, 2.4 mm(f) (1)
<b>Range of operation</b>	620 Mb/s - 13.5 Gb/s
<b>Impedance</b>	50 $\Omega$ typ.
<b>Output amplitude/resolution</b>	0.1 Vpp – 1.8 Vpp / 5 mV
<b>Output voltage window</b>	-2.00 to +3.00 V
<b>Short circuit current</b>	72 mA max.
<b>External termination voltage</b>	-2 V to +3 V (2)
<b>Data formats</b>	Data: NRZ, DNRZ
<b>Addressable technologies</b>	LVDS, CML PECL; ECL (terminated to 1.3 V/0 V/-2 V) low voltage CMOS
<b>Transition times (20% - 80%)</b>	< 20 ps
<b>Jitter</b>	9 ps peak-peak typ. (3)
<b>Cross-point adjustment (Duty cycle distortion)</b>	20%...80% typ.

- (1) In single-ended mode, the unused output must be terminated with 50  $\Omega$  to GND.
- (2) For positive termination voltage or termination to GND, external termination voltage must be less than 3 V below VOH. For negative termination voltage, external termination voltage must be less than 2 V below VOH. External termination voltage must be less than 3 V above VOL.
- (3) Clock out to data out

## Clock OUT

**Table 14. Parameters for N4872A ParBERT 13.5 Gb/s generator**

<b>Clock output</b>	1, differential or single-ended, 2.4 mm(f) (1)
<b>Frequency</b>	620 MHz - 13.5 GHz
<b>Impedance</b>	50 $\Omega$ typ.
<b>Output amplitude/resolution</b>	0.1 Vpp – 1.8 Vpp / 5 mV
<b>Output voltage window</b>	-2.00 to +2.80 V
<b>Short circuit current</b>	72 mA max.
<b>External termination voltage</b>	-2 V to +3 V (2)
<b>Addressable technologies</b>	LVDS, CML PECL; ECL (terminated to 1.3 V/0 V/-2 V) low voltage CMOS
<b>Transition times (10% - 90%)</b>	< 25 ps
<b>Jitter</b>	1 ps RMS typ.
<b>SSB phase noise (10 GHz @ 10 kHz offset, 1 Hz bandwidth)</b>	< -75dBc with clock module E4809A typ.

- (1) In single-ended mode, the unused output must be terminated with 50  $\Omega$  to GND.
- (2) For positive termination voltage or termination to GND, external termination voltage must be less than 3 V below VOH. For negative termination voltage, external termination voltage must be less than 2 V below VOH. External termination voltage must be less than 3 V above VOL.

## Delay control IN

**Table 15. Parameters for N4872A ParBERT 13.5 Gb/s generator**

<b>Delay control input</b>	Single-ended; DC-coupled; SMA(f)
<b>Input voltage window</b>	-250 mV ... +250 mV (DC-coupled)
<b>Input impedance</b>	50 $\Omega$ typ.
<b>Data rate</b>	
Delay range	-100 ps ... +100 ps
Modulation bandwidth	DC ... 1 GHz @ < 10.5 Gb/s

## AUX IN

**Table 16. Parameters for N4872A ParBERT 13.5 Gb/s generator**

<b>Interface</b>	DC coupled, 50 $\Omega$ nominal
<b>Levels</b>	TTL levels
<b>Minimum pulse width</b>	100 ns
<b>Connector</b>	SMA female

## N4873A analyzer module

The analyzer features are:

- Acquire data from start
- Compare and acquire data around error
- Compare and count erroneous ones and zeros to calculate the bit-error-ratio.

Receive memory for acquired data is up to 64 Mbit deep, depending on segment length resolution. The stimulus portion of the channel generates expected data and mask data. Mask data is also available at the maximum segment resolution (32, 64, 128, 256, 512).

The analyzer is able to synchronize on a received data stream by means of a user selectable synchronization word. The sync. word has a length of 48 bits and is composed of zeros, ones and Xs (“don't cares”). The detect word must be unique within the data stream.

Synchronization on a pure PRBS data-stream is done without a detect-word, instead by simply loading a number of the incoming bits into the internal PRBS generator. A pre-condition for this is that the polynomial of the received PRBS is known.

The input comparator has differential inputs with 50 Ω impedance. The sensitivity of 50 mV and the common mode range of the comparator allow the testing of all common differential high-speed devices. The user has the choice of using the differential input with or without a termination voltage or as single-ended input (with a termination voltage). The differential mode does not need a threshold voltage, whereas the single-ended mode does. But also in differential

mode the user can select one of the two inputs and compare the signal to a threshold voltage.

**Table 17. N4873A analyzer timing: all timing parameters are measured at ECL levels, terminated with 50 Ω to GND**

<b>Sampling rate</b>	620 MHz to 13.500 GHz
<b>Sample delay</b>	Can be specified as leading edge delay in fraction of bits in each channel
<b>Start delay range</b>	0 to 100 ns
<b>Fine delay range</b>	± 1 period (can be changed without stopping)
<b>Delay resolution</b>	100 fs
<b>Delay accuracy</b>	±10 ps ± 20 ppm relative to the zero-delay placement. <b>(1)</b>
<b>Relative delay accuracy</b>	±2 ps ± 2% typ. <b>(1)</b>
<b>Skew between modules of same type</b>	20 ps after cable deskewing at customer levels and unchanged system frequency. <b>(1)</b>

(1) 25 °C - 40 °C ambient temperature

**Table 18. N4873A pattern and sequencing**

<b>Analyzer auto-synchronization</b>	On PRBS or memory-based data manual or automatic by: bit synchronization(2) with or without automatic phase alignment automatic delay alignment around a start sample delay (range: ± 10 ns) BER threshold: 10 <sup>-4</sup> to 10 <sup>-9</sup>
--------------------------------------	--

(2) With PRBS data, analyzers can autosynchronize on incoming PRBS data bits. When using memory-based data, this data must contain a unique 48 bit detect word at the beginning of the segment, and the generators must be on a separate system clock. Don't cares within detect word are possible. If several inputs synchronize, the delay difference between terminals must be smaller than ±5 segment length resolution.

**Table 19. Parameters for N4873A ParBERT 13.5 Gb/s analyzer**

<b>Number of channels</b>	1, differential or single ended, 2.4 mm (f)
<b>Range of operation</b>	620 Mb/s - 13.5 Gb/s
<b>Max input amplitude</b>	2 Vpp
<b>Input sensitivity</b>	50 mVpp typical @ 10 Gb/s, PRBS 2 <sup>31</sup> - 1, and BER 10 <sup>-12</sup>
<b>Input voltage range</b>	-2V ... +3 (selectable 2 V window)
<b>Internal termination voltage (can be switched off)</b>	-2.0 to +3.0 V (must be within selected 2 V window)
<b>Threshold voltage range</b>	-2.0 to + 3.0 V (must be within selected 2 V window)
<b>Threshold resolution</b>	0.1 mV
<b>Minimum detectable pulse width</b>	25 ps typ.
<b>Phase margin (Source: N4872A)</b>	1 UI - 12 ps typ.
<b>Impedance</b>	50 Ω typ. (100 Ω differential, if termination voltage is switched off)

## Clock data recovery

The analyzer module has integrated CDR capabilities, which allow the recovery of either clock or data. Before the CDR can lock onto the incoming data stream, the data rate must be defined within the user interface; common data rates are pre-defined. In CDR mode, phase alignment to the center of the eye is done automatically during synchronization. For correct operation, the CDR output must be connected to the clock input of the E4809A 13.5 GHz central clock module. In addition the generator clock source and the analyzer clock source must be independent.

### AUX OUT

The AUX OUT provides data or recovered clock signals.

### AUX IN

**Gating functionality:** If a high level is applied at AUX IN, comparison is disabled and internal counters are stopped. After resuming a low level at AUX IN, comparison is enabled and internal counters continue. The internal sequencing is not stopped.

### ERROR OUT

Whenever one or more bit errors are detected, the error out signal is high for one segment resolution. A high period is always followed by a low period (RZ-format) in order to ensure trigger possibility on continuous errors.

**Table 20. Parameters for N4873A ParBERT 13.5 Gb/s analyzer - clock data recovery**

<b>Common data rates</b>	OC-192:	9.953 Gb/s
	10GbE:	10.3125 Gb/s
	Fiber channel:	10.51875 Gb/s
	G.709/G.975:	10.664 Gb/s/10.709 Gb/s
	S-ATA/FireWire:	6.4 Gb/s
	PCI-Express:	6.4 Gb/s
	OC-48:	2.488 Gb/s
	10GbE:	3.125 Gb/s
<b>Frequency ranges</b>	SAN:	3.187 Gb/s
	S-ATA/FireWire:	3.2 Gb/s
	9.9 GHz ...10.90 GHz	
	4.23 GHz ...6.40 GHz	
	2.115 GHz... 3.20 GHz	
	1.058 GHz....1.6 GHz	(1)

The CDR works with specified PRBS patterns up to  $2^{31} - 1$ ,  
The CDR expects a DC balanced pattern,  
The CDR expects a transition density of one transition for every second bit.

(1) Available for hardware S/N : DE43A00401 and software rev. 5.62

**Table 21. Parameters for N4873A 13.5 Gb/s analyzer - AUX OUT**

<b>Interface</b>	AC coupled, 50 $\Omega$ nominal
<b>Amplitude</b>	600 mV nominal
<b>Output jitter (clock @ AUX OUT)</b>	0.01 UI rms typical
<b>Connector</b>	SMA female

**Table 22. Parameters for N4873A 13.5 Gb/s analyzer - AUX IN**

<b>Resolution</b>	Segment resolution
<b>TTL compatible</b>	Internal 500 $\Omega$ termination to GND
<b>Threshold</b>	@ 1.5 V
<b>Connector</b>	SMA female
<b>Low (0...1 V)</b>	Internal counters are enabled
<b>High (2 V...4 V)</b>	Internal counters are stopped
<b>Open</b>	Same as low

**Table 23. Parameters for N4873A 13.5 Gb/s analyzer - ERROR OUT**

<b>Format</b>	RZ; active high
<b>Output high level</b>	0 V $\pm$ 100 mV
<b>Output low level</b>	+1 V $\pm$ 100 mV
<b>Connector</b>	SMA female

## Ordering information

**N4872A**  
ParBERT 13.5 Gb/s generator module  
**N4873A**  
ParBERT 13.5 Gb/s analyzer module  
**E4809A**  
13.5 GHz central clock module

### Accessories:

**N4910A**  
2.4 mm matched cable pair  
**N4912A**  
2.4 mm 50  $\Omega$  termination male connector  
**N4913A**  
4 GHz deskew probe for E4809A

## Technical specifications

All specifications describe the instrument's warranted performance. Non-warranted values are described as typical. All specifications are valid from 10 to 40 °C ambient temperature after a 30 minute warm-up phase, with outputs and inputs terminated with 50  $\Omega$  to ground at ECL levels if not specified otherwise.

# Agilent ParBERT 81250

## Agilent E4866A ParBERT 10.8 Gb/s Generator Module

## Agilent N4868A ParBERT Booster Module

## Agilent E4867A ParBERT 10.8 Gb/s Analyzer Module

### Technical Specifications

#### General

The E4866A is a 10.8 Gb/s generator module. The N4868A is a booster module for the E4866A. The E4867A is a 10.8 Gb/s analyzer module.

#### Clock timing

The generator provides complementary data and single-ended clock output. Both clock out and data out can be moved with the variable delay; it is the same delay for both. The analyzer also has a variable sampling delay. This consists of two parts:

- 1) the start delay with a large range
- 2) the time delay of the  $\pm 1$  period without stopping.

#### Data capabilities

PRBS/PRWS and memory-based data are defined by segments. Segments are assigned to a generator for a stimulating pattern. On an analyzer it defines the expected pattern where the incoming data are compared to. The expected pattern can be setup with mask bits. The segment length resolution is the resolution to which the length of a pattern segment can be set. The segment length resolution is 256 bits for a total of 32 MB memory.



Fig 19. E4866A generator module

Table 24. E4866A timing specifications (@ 50% of amplitude, 50  $\Omega$  to GND)

<b>Data range</b>	9.5 Gb/s to 10.8 Gb/s
<b>Clock range</b>	9.5 GHz to 10.8 GHz
<b>Delay range</b>	0 to 300 ns
<b>Delay resolution</b>	1 ps
<b>Accuracy</b>	$\pm 20$ ps $\pm 50$ ppm relative to the zero-delay placement.
<b>Skew between modules of same type</b>	50 ps typ. after deskewing at customer levels and unchanged system frequency

Table 25. E4866A pattern and sequencing

<b>Segment length resolution</b>	256 bits
<b>Patterns:</b>	
<b>Memory based</b>	up to 32 Mbit
<b>PRBS/PRWS</b>	$2^n - 1$ , $n = 7, 9, 10, 11, 15, 23, 31$
<b>Mark density</b>	1/8, 1/4, 1/2, 3/4, 7/8 at $2^n - 1$ , $n = 7, 9, 10, 11, 15$
<b>Errored PRBS/PRWS</b>	$2^n - 1$ , $n = 7, 9, 10, 11, 15$
<b>Extended ones or zeros</b>	$2^n - 1$ , $n = 7, 9, 10, 11, 15$

#### AC coupling behind sampling circuit

The AC coupling does not impact the performance of the analyzer as long as the input data is balanced or the following limitations are not exceeded:

1. For infinite time period a mark density from 9/10 to 10/9 is tolerated.
2. All zero or all one patterns must not be longer than 20000 bits or 2  $\mu$ s.
3. When data recovers from imbalanced pattern to a balanced pattern a settling time of maximum 200  $\mu$ s takes effect.

**Table 26. Parameters for clock output E4866A 10.8 GHz**

<b>Output duty cycle</b>	1, single ended, AC coupled, to be used into 50 Ω
<b>Maximum external voltage</b>	50% typical;
<b>Amplitude/resolution</b>	-2.2 V to +3.3 V
<b>Transition times (20% - 80%)</b>	0.5 Vpp fixed typ.
<b>Clock jitter</b>	sine wave
	< 2 ps RMS

**Booster N4868A**

The N4868A delivers either 1 differential channel or 2 single-ended channels. The N4868A-001 delivers either 2 differential or 4 single-ended channels. For differential operation it is recommended that the N4869A cable kit be used with phase adjustment capability for the differential path. For the N4868A -001 two cable kits would be needed if both are used as differential. The N4868A-001 can also be used 1x differential and 2x single-ended to boost the clock output of the E4866A.

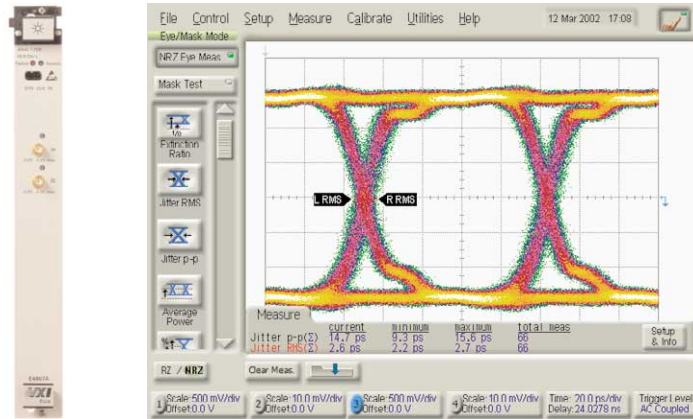

**Fig 20. E4868A booster and wave diagram**

**Table 27. Parameters for data output E4866A 10.8 Gb/s with N4868A booster(1)**

<b>Outputs</b>	1, differential, 50 Ω typ.	1, differential or 2, single-ended
<b>Data formats</b>	NRZ	NRZ
<b>Amplitude/resolution</b>	0.3 V to 1.8 V/10 mV	1.0 V to 2.5 V
<b>Accuracy hi level/amplitude</b>	±2% ±10 mV	±5% ±50 mV
<b>External termination voltage</b>	-2 V to +1.5 V	
<b>Output voltage window</b>	-2.0 to +2.7 V	AC coupled
<b>Maximum external voltage</b>	-2.2 V to +3.3 V	
<b>Enable/disable</b>	Relay	-
<b>Transition times (20% - 80%)</b>	< 60 ps	< 20 ps (15 ps typ.)
<b>Overshoot/ringing</b>	10% +20 mV typ.	-
<b>Jitter</b>	< 25 ps peak-to-peak (20 ps typ.)	< 25 ps peak-to-peak

(1) Booster input to be driven with 1.8 V amplitude from E4866A generator

**E4867A analyzer module**

The E4867A is a 10.8 Gb/s analyzer module which is one VXI slot wide and operates in a range from 9.5 Gb/s up to 10.8 Gb/s. The ParBERT 10.8 Gb/s modules requires the E4808A central clock module.

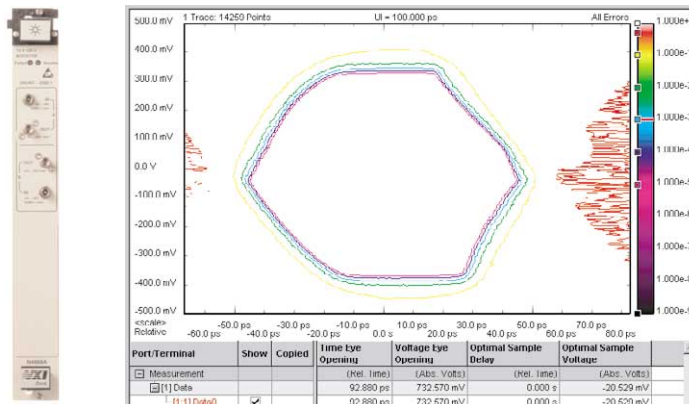

**Figure 21. E4867A analyzer with eye diagram**



**Table 28. E4867A timing specifications (@ 50% of amplitude, 50 Ω to GND)**

<b>Data range</b>	9.5 Gb/s to 10.8 Gb/s
<b>Delay (between channels)</b>	Can be specified as leading edge delay (start delay) in fraction of bits in each channel, fine delay can be changed without stopping the instrument
<b>Start delay range</b>	0 to 300 ns (not limited by period)
<b>Fine delay range</b>	±1 period (without stopping)
<b>Resolution</b>	1 ps
<b>Accuracy</b>	±20 ps ±50 ppm relative to the zero-delay placement.
<b>Skew between modules of same type</b>	50 ps typ. after deskewing at customer levels and unchanged system frequency
<b>Sampling delay resolution</b>	100 ps

**Table 29. E4867A pattern and sequencing**

<b>Segment length resolution</b>	256 bits
<b>Patterns:</b>	
<b>Memory based</b>	Up to 32 Mbit
<b>PRBS/PRWS</b>	$2^n - 1$ , $n = 7, 9, 10, 11, 15, 23, 31$
<b>Mark density</b>	1/8, 1/4, 1/2, 3/4, 7/8 at $2^n - 1$ , $n = 7, 9, 10, 11, 15$
<b>Errored PRBS/PRWS</b>	$2^n - 1$ , $n = 7, 9, 10, 11, 15$
<b>Extended ones or zeros</b>	$2^n - 1$ , $n = 7, 9, 10, 11, 15$
<b>User</b>	Data editor, file import
<b>Analyzer expected data</b>	
<b>Mark density</b>	9/10...10/9
Max consecutive 0 or 1	20000 or 2 μs
Data recovery from imbalanced	200 μs
<b>Analyzer auto-synchronization</b>	on PRBS or memory-based data manual or automatic by: Bit synchronization(1) with or without automatic phase alignment. Automatic delay alignment around a start sample delay Range ± 10 ns BER threshold: $10^{-4}$ to $10^{-9}$

(1) Bit synchronization on data is achieved by detecting a 48 bit unique word at the beginning of the segment. ("Don't care" can be programmed within the detect word). In this mode memory-based data cannot be sent within the same system. If several inputs synchronize, the delay difference between the terminals must be smaller ±5 segment length resolution.

**Table 30. Parameters for analyzer module E4867A 10.8 Gb/s**

<b>Inputs</b>	1, differential or single-ended
<b>Impedance</b>	50 Ω typ. 100 Ω differential if termination voltage is switched off
<b>Input sensitivity</b>	100 mV typ., single-ended and differential
<b>Internal termination voltage</b>	-2.0 to +2.0 V, can be switched off
<b>Threshold voltage range</b>	-2.0 to + 2.0 V
<b>Threshold resolution</b>	1 mV
<b>Threshold accuracy</b>	± 2% ±20 mV
<b>Maximum input voltage range</b>	
Three ranges selectable:	-2 V to + 0 V, -1 V to +1 V, 0 V to 2 V
<b>Maximum differential voltage</b>	1.2 V
<b>Enable/disable</b>	Relay
<b>Bandwidth, equivalent transition time (20% - 80%)</b>	35 ps typ.
<b>Minimum detectable pulse width</b>	Data: 80 ps typ. Continuous clock: 40 ps typ.
<b>Phase margin with ideal input signal with E4866A generator.</b>	> 1 UI -15 ps > 1 UI -33 ps

## Synchronization

Synchronization is the method of automatically adjusting the proper bit phase for data comparison on the incoming bit stream. The synchronization can be performed on PRBS/PRWS and memory-based data (it is not possible with a mix of PRxS and memory-based data). There are two types of synchronization:

- Bit synchronization
- Auto delay alignment

Memory-based bit synchronization is able to cover a bit alignment for a totally unknown number of cycles. Using data, the first 48 bit within the expected data segment will work as a DETECT word where the incoming data are compared to. When the incoming data match with this “detect word”, further analysis is started.

Auto delay alignment is performed using the analyzer sampling delay. The sampling delay range is  $\pm 10$  ns.

Using auto delay alignment provides synchronization with an absolute timing relation between a group of analyzer channels. Therefore skew measurements will be possible.

## Input/output

### Addressable technologies:

**CML, SSTL-2, ECL (terminated to 0 V/-2 V), LVPECL, (terminated to 1.3 V)**

### Generator out

The generator output can be used as single-ended or differential. Enable/disable relay provides on/off switching. Switched off provides internal termination. It is recommended either to turn off or externally terminate unused outputs.

The generator outputs can work into  $50 \Omega$  center tapped termination or  $100 \Omega$  differential termination. The proper termination scheme can be chosen from the editor to adapt proper level programming.

## Analyzer input

The analyzer input provides excellent performance with more than a 90% eye opening with an “ideal” input signal (10 ps transition time).

The analyzer channels can be operated:

- Single-ended normal
- Single-ended compliment
- Differential

For termination there is always  $50 \Omega$  connected to a programmable termination voltage. In differential mode there is an additional, selectable  $100 \Omega$  differential termination. Independently of the selected termination, one can select whether the analysis of the incoming signal is performed on the input, the complimentary input or true differential.

# Agilent ParBERT 81250

## Agilent N4874A ParBERT 7 Gb/s Generator Agilent N4875A ParBERT 7 Gb/s Analyzer

### Technical Specifications

#### General

The N4874A generator and N4875A analyzer modules are each one VXI slot wide and operate in a range from 620 Mb/s up to 7 Gb/s. The ParBERT 7 Gb/s modules require the E4809A 13.5 GHz central clock module. All specifications, if not otherwise stated, are valid at the end of the recommended N4910A cable set (24" matched pair 2.4 mm).

The N4874A generator module generates hardware-based PRBS up to  $2^{31} - 1$ , PRWS and user-defined patterns and provides a memory depth of 64 Mbit. The N4875A can synchronize on a 48bit detect word, or on a pure PRBS pattern without detect word.

#### Timing specifications

The ParBERT 13.5 Gb/s modules are able to work with three different clock modes.

- *Internal clock mode:* The common clock mode is provided by the E4809A 13.5 GHz central clock module, which generates clock frequencies up to 13.5 GHz.
- *External clock mode:* The system also works synchronously with an external clock, which is connected to the E4809A clock module.

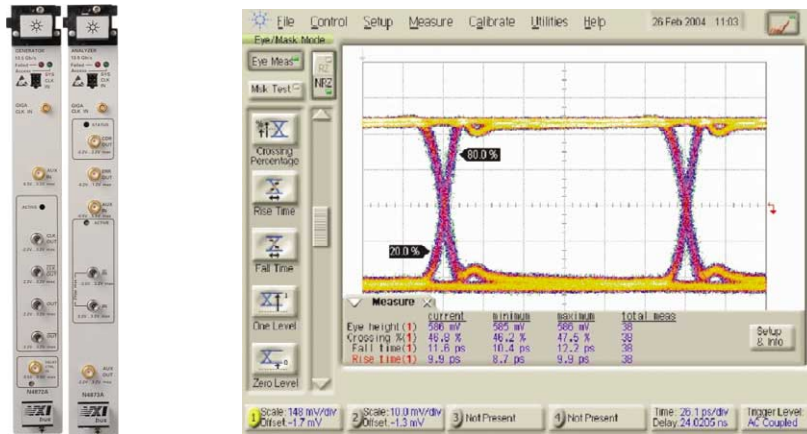

Figure 22. N4874A & N4875A and waveform

**Table 31. N4874A data generator timing specifications (@ 50% of amplitude, 50 Ω to GND)**

<b>Frequency range</b>	620 MHz to 7 GHz
<b>Delay = start delay + fine delay</b>	Can be specified as leading edge delay in fraction of bits in each channel
<b>Start delay range</b>	0 to 100 ns
<b>Fine delay range</b>	± 1 period (can be changed without stopping)
<b>Delay resolution</b>	100 fs
<b>Delay accuracy</b>	±10 ps ± 20 ppm relative to the zero-delay placement. (@ 25 °C - 40 °C ambient temp.)
<b>Relative delay accuracy</b>	±2 ps ± 2% typ. (@ 25 °C - 40 °C ambient temp.)
<b>Skew between modules of same type</b>	20 ps after cable deskewing at customer levels and unchanged system frequency. (@ 25 °C - 40 °C ambient temp.)

- *CDR mode:* To use the N4875A 7 Gb/s analyzer CDR capabilities, connect the analyzer's CDR out to the E4809A clock module's clock in.

## Sequencing

The sequencer receives instructions from the central sequencer and generates a sequence. The channel sequencer can generate a sequence with up to 60 segments.

An analyzer channel generates feedback signals that can control the channel sequencer and/or the central sequencer. With parallel analyzer channels, the feedback is routed to the central sequencer to allow a common response of all parallel channels. With single receive channel, the channel sequencer itself handles the feedback signals.

## Pattern generation

The data stream is composed of segments. A segment can be made up of a memory-based pattern, memory-based PRBS or hardware generated PRBS. A total of 64 Mbit (at segment length resolution 512 bits) are available for memory-based pattern and PRBS.

Memory-based PRBS is limited to  $2^{15} - 1$  or shorter. Memory-based PRBS allows special PRBS modes like zero substitution (also known as extended zero run) and variable mark ratio.

A zero substitution pattern extends the longest zero series by a user selectable number of additional zeroes. The next bit following these zero series will be forced to 1. Mark ratio is the ratio of 1 s and 0 s in a PRBS stream, which is 1/2 in a normal PRBS. Variable mark ratio allows values of 1/8, 1/4, 1/2, 3/4 and 7/8.

Due to granularity reasons a PRBS has to be written to RAM several times, at a multiplexing factor of 512 the number of repetitions is also 512. That means that a  $2^{15} - 1$  PRBS uses up to 16 Mbit of the memory. Hardware-based PRBS can be a polynomial up to  $2^{31} - 1$ . No memory is used for hardware-based pattern generation. Error insertion allows inserting single or multiple errors into a data stream. So instead of a 0 a 1 is generated and vice versa.

**Table 32. N4874A pattern and sequencing**

<b>Segment length resolution</b>	512 bit
<b>Patterns:</b>	
<b>Memory based</b>	up to 64 Mbit
<b>PRBS/PRWS</b>	$2^n - 1$ , n = 7, 9, 10, 11, 15, 23, 31
<b>Mark density</b>	1/8, 1/4, 1/2, 3/4, 7/8 at $2^n - 1$ , n = 7, 9, 10, 11, 15
<b>Errored PRBS/PRWS</b>	$2^n - 1$ , n = 7, 9, 10, 11, 15
<b>Extended ones or zeros</b>	$2^n - 1$ , n = 7, 9, 10, 11, 15
<b>Clock patterns</b>	Divide or multiply by 1, 2, 4
<b>PRWS port width</b>	1, 2, 4, 8, 16

**Table 33. Data rate range, segment length resolution, available memory for synchronization and fine delay operation**

<b>Data rate range (Mbit/s)</b>	<b>Segment length resolution</b>	<b>Maximum memory depth (bits)</b>
620 ... 1.350,000	32 bits	4.194,304
620 ... 2.700,000	64 bits	8.388,608
620 ... 5.400,000	128 bits	16.777,216
620 ... 7.000,000	256 bits	33.554,432
620 ... 7.000,000	512 bits	67.108,864

## N4874A generator module

The N4874A generates differential or single-ended data and clock signals operating from 620 Mb/s up to 7 Gb/s. The output levels are able to drive high-speed devices with interfaces like LVDS, ECL, PECL, CML and low voltage CMOS. The nominal output impedance is 50 Ω typical. The delay control IN has a single-ended input with 50 Ω impedance. The input voltage allows modulation of a delay element up to 1 GHz (200 ps) within the generator's differential output. See figure 25c - 26c on page 36.

The AUX IN has a single-ended input with a 50 Ω impedance. The AUX IN allows injecting gating signals. An active (TTL high) signal at the auxiliary input forces (gates) the data to a logic zero.

## Data OUT

**Table 34. Parameters for N4874A ParBERT 7 Gb/s generator**

<b>Data output</b>	1, differential or single ended, 2.4 mm(f) (1)
<b>Range of operation</b>	620 Mb/s - 7 Gb/s
<b>Impedance</b>	50 Ω typ.
<b>Output amplitude/resolution</b>	0.1 V <sub>pp</sub> – 1.8 V <sub>pp</sub> / 5 mV
<b>Output voltage window</b>	-2.00 to +3.00 V
<b>Short circuit current</b>	72 mA max.
<b>External termination voltage</b>	-2 V to +3 V (2)
<b>Data formats</b>	Data: NRZ, DNRZ
<b>Addressable technologies</b>	LVDS, CML PECL - 3.3 V; ECL (terminated to 1.3 V/0 V/-2 V) low voltage CMOS, LVDS, CML
<b>Transition times (20% - 80%)</b>	< 20 ps
<b>Jitter</b>	9 ps peak-peak typ. (3)
<b>Cross-point adjustment</b>	20%...80% typ.

- (1) In single-ended mode, the unused output must be terminated with 50 Ω to GND.  
 (2) For positive termination voltage or termination to GND, external termination voltage must be less than 3 V below VOH. For negative termination voltage, external termination voltage must be less than 2 V below VOH. External termination voltage must be less than 3 V above VOL.  
 (3) Clock out to data out.

## Clock OUT

**Table 35. Parameters for N4874A ParBERT 7 Gb/s generator**

<b>Clock output</b>	1, differential or single-ended, 2.4 mm(f) (4)
<b>Frequency</b>	620 MHz - 7 GHz
<b>Impedance</b>	50 Ω typ.
<b>Output amplitude/resolution</b>	0.1 V <sub>pp</sub> – 1.8 V <sub>pp</sub> / 5 mV
<b>Output voltage window</b>	-2.00 to +2.80 V
<b>Short circuit current</b>	72 mA max.
<b>External termination voltage</b>	-2 V to +3 V (5)
<b>Addressable technologies</b>	LVDS, CML PECL; ECL (terminated to 1.3V/0 V/-2 V) low voltage CMOS
<b>Transition times (10% - 90%)</b>	< 25 ps
<b>Jitter</b>	1 ps RMS typ.
<b>SSB phase noise (10 GHz @ 10 kHz offset, 1 Hz bandwidth)</b>	< - 75 dBc with clock module E4809A typ.

- (4) In single-ended mode, the unused output must be terminated with 50 W to GND.  
 (5) For positive termination voltage or termination to GND, external termination voltage must be less than 3 V below VOH. For negative termination voltage, external termination voltage must be less than 2 V below VOH. External termination voltage must be less than 3 V above VOL.

## Delay control IN

**Table 36. Parameters for N4874A ParBERT 7 Gb/s generator**

<b>Delay control input</b>	Single-ended; DC-coupled; SMA(f)
<b>Input voltage window</b>	-250 mV ... +250 mV (DC-coupled)
<b>Input impedance</b>	50 Ω typ.
<b>Delay range</b>	-100 ps ... +100 ps
<b>Modulation bandwidth</b>	DC ... 1 GHz @ data rate < 10.5 Gb/s

## AUX IN

**Table 37. Parameters for N4874A ParBERT 7 Gb/s generator**

<b>Interface</b>	DC coupled, 50 Ω nominal
<b>Levels</b>	TTL levels
<b>Minimum pulse width</b>	100 ns
<b>Connector</b>	SMA female

## N4875A analyzer module

The analyzer features are:

- Acquire data from start
- Compare and acquire data around error
- Compare and count erroneous ones and zeros to calculate the bit error ratio

Receive memory for acquired data is up to 64 Mbit deep, depending on segment length resolution. The stimulus portion of the channel generates expected data and mask data. Mask data is also available at the maximum segment resolution (32, 64, 128, 256, 512).

The analyzer is able to synchronize on a received data stream by means of a user selectable synchronization word. The sync word has a length of 48 bits and is composed of zeros, ones and Xs ("don't cares"). The detect word must be unique within the data stream. Synchronization on a pure PRBS data-stream is done without a detect-word, instead by simply loading a number of the incoming bits into the internal PRBS generator. A pre-condition for this is that the polynomial of the received PRBS is known.

The input comparator has differential inputs with 50  $\Omega$  impedance. The sensitivity of 50 mV and the common mode range of the comparator allow the testing of all common differential high-speed devices. The user has the choice of using the differential input with or without a termination voltage or as single-ended input (with a termination voltage). The differential mode does not need a threshold voltage, whereas the single-ended mode does. But also in differential mode the user can select one of the two inputs and compare the signal to a threshold voltage.

**Table 38. N4875A analyzer timing: all timing parameters are measured at ECL levels, terminated with 50  $\Omega$  to GND**

<b>Sampling rate</b>	620 MHz to 7 GHz
<b>Sample delay</b>	Can be specified as leading edge delay in fraction of bits in each channel
<b>Start delay range</b>	0 to 100 ns
<b>Fine delay range</b>	$\pm 1$ period (can be changed without stopping)
<b>Delay resolution</b>	100 fs
<b>Delay accuracy</b>	$\pm 10$ ps $\pm 20$ ppm relative to the zero-delay placement <b>(1)</b>
<b>Relative delay accuracy</b>	$\pm 2$ ps $\pm 2\%$ typ. <b>(1)</b>
<b>Skew between modules of same type</b>	20 ps after cable deskewing at customer levels and unchanged system frequency. <b>(1)</b>

(1) 25  $^{\circ}$ C - 40  $^{\circ}$ C ambient temperature

**Table 39. N4875A pattern and sequencing**

<b>Analyzer auto-synchronization</b>	On PRBS or memory-based data Manual or automatic by: Bit synchronization(2) with or without automatic phase alignment Automatic delay alignment around a start sample delay (range: $\pm 10$ ns) BER Threshold: $10^{-4}$ to $10^{-9}$
--------------------------------------	--

(2) With PRBS data, analyzers can autosynchronize on incoming PRBS data bits. When using memory-based data, this data must contain a unique 48 bit detect Word at the beginning of the segment, and the generators must be on a separate system clock. Don't cares within detect word are possible. If several inputs synchronize, the delay difference between terminals must be smaller than  $\pm 5$  segment length resolution.

### Data IN

**Table 40. Parameters for N4875A ParBERT 7 Gb/s analyzer**

<b>Number of channels</b>	1, differential or single ended, 2.4 mm (f)
<b>Range of operation</b>	620 Mb/s - 7 Gb/s
<b>Max input amplitude</b>	2 Vpp
<b>Input sensitivity</b>	50 mVpp typical @ 10 Gb/s, PRBS $2^{31} - 1$ , and BER $10^{-12}$
<b>Input voltage range</b>	-2V ... +3 (selectable 2V window)
<b>Internal termination voltage (can be switched off)</b>	-2.0 to +3.0 V (must be within selected 2 V window)
<b>Threshold voltage range</b>	-2.0 to + 3.0 V (must be within selected 2 V window)
<b>Threshold resolution</b>	0.1 mV
<b>Minimum detectable pulse width</b>	25 ps typ.
<b>Phase margin (source: N4874A)</b>	1 UI - 12 ps typ.
<b>Impedance</b>	50 $\Omega$ typ. (100 $\Omega$ differential, if termination voltage is switched off)
<b>Sampling delay resolution</b>	100 fs

## Clock data recovery

The analyzer module has integrated CDR capabilities, which allow the recovery of either clock or data. Before the CDR can lock onto the incoming data stream, the data rate must be defined within the user interface; common data rates are pre-defined. In CDR mode, phase alignment to the center of the eye is done automatically during synchronization. For correct operation, the CDR output must be connected to the clock input of the E4809A central clock module. In addition the generator clock source and the analyzer clock source must be independent.

### AUX OUT

The AUX OUT provides data or recovered clock signals.

### AUX IN

Gating functionality: if a high level is applied at AUX IN, comparison is disabled and internal counters are stopped. After resuming a low level at AUX IN, comparison is enabled and internal counters continue. The internal sequencing is not stopped.

### ERROR OUT

Whenever one or more bit errors are detected, the error out signal is high for one segment resolution. A high period is always followed by a low period (RZ-format) in order to ensure trigger possibility on continuous errors.

**Table 41. Parameters for N4875A ParBERT 7 Gb/s analyzer - clock data recovery**

<b>Common data rates</b>	S-ATA/FireWire:	6.4 Gbit/s
	PCI-Express:	6.4 Gbit/s
	OC-48:	2.488 Gbit/s
	10GbE:	3.125 Gbit/s
	SAN:	3.187 Gbit/s
	S-ATA/FireWire:	3.2 Gbit/s
<b>Frequency ranges</b>	4.23 GHz ... 6.4 GHz	
	2.115 GHz ... 3.2 GHz	
	1.058 GHz...1.6 GHz	(1)

The CDR works with specified PRBS patterns up to  $2^{31} - 1$ ,  
The CDR expects a DC balanced pattern,  
The CDR expects a transition density of one transition for every second bit.

(1) Available for hardware S/N: DE43A00401 and software rev. 5.62

**Table 42. Parameters for N4875A 7 Gb/s analyzer - AUX OUT**

<b>Interface</b>	AC Coupled, 50 $\Omega$ nominal
<b>Amplitude</b>	600 mV nominal
<b>Output jitter (clock @ AUX OUT)</b>	0.01 UI rms typical
<b>Connector</b>	SMA female

**Table 43. Upgrades 7 Gb/s - 13 Gb/s**

Order No.	Feature
<b>E4860AS-290</b>	Upgrade N4874A to 13.5 Gb/s
<b>E4860AS-291</b>	Upgrade N4875A to 13.5 Gb/s

**Table 44. Parameters for N4875A 13.5 Gb/s analyzer - AUX IN**

<b>Resolution</b>	Segment resolution
<b>TTL compatible</b>	Internal 500 $\Omega$ termination to GND;
<b>Threshold</b>	@ 1.5 V
<b>Connector</b>	SMA female
<b>Low (0...1 V)</b>	Internal counters are enabled
<b>High (2 V...4 V)</b>	Internal counters are stopped
<b>Open</b>	Same as low

**Table 45: Parameters for N4875A 13.5 Gb/s analyzer - ERROR OUT**

<b>Format</b>	RZ; active high
<b>Output high level</b>	0 V $\pm$ 100 mV
<b>Output low level</b>	+1 V $\pm$ 100 mV
<b>Connector</b>	SMA female

## Ordering information

- N4874A** ParBERT 7 Gb/s generator module
- N4875A** ParBERT 7 Gb/s analyzer module
- E4809A** Central clock module

### Accessories:

- N4910A** 2.4 mm matched cable pair
- N4912A** 2.4 mm 50 termination male connector
- N4913A** 4 GHz deskew for E4809A

## Technical specifications

All specifications describe the instrument's warranted performance. Non-warranted values are described as typical. All specifications are valid from 10 to 40 °C ambient temperature after a 30 minute warm-up phase, with outputs and inputs terminated with 50  $\Omega$  to ground at ECL levels if not specified otherwise.

# Agilent E4861B ParBERT 3.35 Gb/s Data Module

## Agilent E4862B ParBERT 3.35 Gb/s Generator Front-End

## Agilent E4863B ParBERT 3.35 Gb/s Analyzer Front-End

### Technical Specifications

#### General

A ParBERT 3.35 Gb/s module can house up to two front-ends, either two generators or analyzers or any mix. ParBERT 3.35 Gb/s modules work with the E4808A or E4890A clock modules. The key specifications of ParBERT 3.35 Gb/s modules are:

- 21 MHz ... 3.350 GHz clock/data rate
- 16 Mbit memory depth at each channel
- HW-based PRBS generation up to the polynomial of  $2^{31} - 1$
- Analyzer can synchronize on a 48 bit detect word (memory-based data)
- Analyzer can synchronize on a pure PRBS pattern without detect word

#### Timing capabilities

The frequency range of the modules is 21 MHz ... 3.350 GHz. The ParBERT 3.35 Gb/s front-ends use a multiplying PLL that multiplies system master clock by 4 or 8. Through the clock module, an external clock source can be used. This external clock must run continuously. If the clock signal is interrupted, the multiplying PLLs typically needs 100 milliseconds to lock onto the clock again.

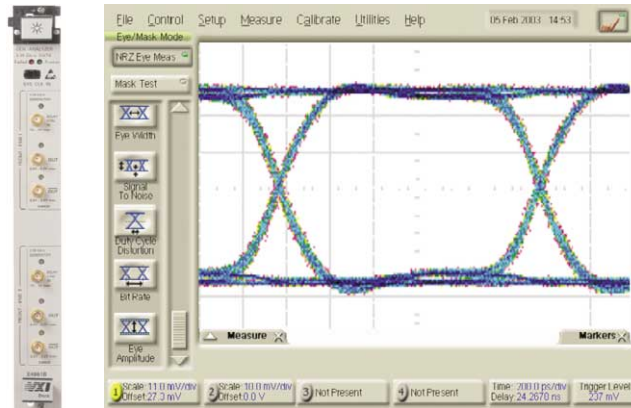

**Figure 23. E4861B data module and E4862B generator front-end with waveform**

**Table 46. E4861B data generator timing specification (@ 50% of amplitude, 50 Ω to GND)**

<b>Frequency range</b>	20.834 MHz to 3.350 GHz
<b>Delay = start delay + fine delay</b>	Can be specified as leading edge delay in fraction of bits in each channel
<b>Start delay range</b>	0 to 200 ns (not limited by period)
<b>Fine delay range</b>	±1 period (can be changed without stopping)
<b>Delay resolution</b>	1 ps
<b>Accuracy data mode</b>	±25 ps ±50 ppm relative to the zero-delay and temperature change within ±10 °C after autocalibration
<b>Clock mode</b>	±50 ps ±50 ppm relative to the zero-delay
<b>Skew between modules of same type (data mode)</b>	50 ps typ. after deskewing at customer levels and unchanged system frequency

**The variable delay is available in data mode and pulse mode. In clock mode the timing is fixed.**

#### Sequencing

The sequencer receives instructions from the clock module. The channel sequencer can generate a sequence with up to 60 segments. An analyzer channel can generate feedback signals which are combined in the clock module for a common response of all parallel channels. With a single receiver channel the channel sequencer itself handles the feedback signals.



**Table 47. E4861B analyzer timing all timing parameters are measured at ECL levels, terminated with 50 Ω to GND**

<b>Sampling rate</b>	20.834 MHz to 3.350 GHz
<b>Sample delay</b>	Same as delay = start delay + fine delay Can be specified as leading edge delay in fraction of bits in each channel
<b>Start delay range</b>	0 to 200 ns (not limited by period)
<b>Fine delay range</b>	±1 period (can be changed without stopping)
<b>Resolution</b>	1 ps
<b>Accuracy</b>	±25 ps ±50 ppm relative to the zero-delay and temperature change within ±10 °C after autocalibration
<b>Skew</b>	50 ps typ. after deskewing at customer levels and unchanged system frequency

**Table 48. E4861B pattern and sequencing**

<b>Patterns</b>	
<b>Memory based</b>	Up to 16 Mbit
<b>PRBS/PRWS</b>	$2^n - 1$ , n = 7, 9, 10, 11, 15, 23, 31
<b>Mark density</b>	1/8, 1/4, 1/2, 3/4, 7/8 at $2^n - 1$ , n = 7, 9, 10, 11, 15
<b>Errored PRBS/PRWS</b>	$2^n - 1$ , n = 7, 9, 10, 11, 15
<b>Extended ones or zeros</b>	$2^n - 1$ , n = 7, 9, 10, 11, 15
<b>Clock patterns</b>	Divide or multiply by 1, 2, 4
<b>Analyzer auto-synchronization</b>	On PRBS or memory-based data Manual or automatic by: Bit synchronization(1) with or without automatic phase alignment. Automatic delay alignment around a start sample delay (range: ± 10 ns) BER threshold: $10^{-4}$ to $10^{-9}$

(1) With PRBS data, analyzers can autosynchronize on incoming PRBS data bits. When using memory-based data, this data must contain a unique 48 bit detect word at the beginning of the segment, and the generators must be on a separate system clock. "Don't cares" within detect word are possible. If several inputs synchronize, the delay difference between terminals must be smaller than ±5 segment length resolution.

**Table 49. Data rate range, segment length resolution, available memory for synchronization and fine delay operation**

<b>Data rate range Mb/s</b>	<b>Segment length</b>	<b>Maximum memory resolution depth, bits</b>
20.834 ... 41.666	1 bit	131,072
20.834 ... 82.333	2 bits	262,144
20.834 ... 166.666	4 bits	524,288
20.834 ... 333.333	8 bits	1,048,576
20.834 ... 666.666	16 bits	2,097,152
20.834 ... 1,333.333	32 bits	4,194,304
20.834 ... 2,700.000	64 bits	8,388,608
20.834 ... 3,350.000	128 bits	16,777,216

**Table 50. Dependency of PRWS generation and port width.**

<b>PRWS</b>	<b>Port width</b>
$2^7 - 1$	No restriction
$2^9 - 1$	7
$2^{10} - 1$	3, 11, 31, 33
$2^{11} - 1$	23
$2^{15} - 1$	7, 31
$2^{23} - 1$	47
$2^{31} - 1$	No restriction

## Pattern generation

The data stream is composed of segments. A segment can be a memory-based pattern, memory-based PRBS or hardware generated PRBS. A total of 16 Mbit (at segment length resolution 128 bits) are available for memory-based pattern and PRBS.

Memory-based PRBS is limited to  $2^{15} - 1$  or shorter. Memory-based PRBS allows special PRBS modes like zero substitution (also known as extended zero run) and variable mark ratio. A zero substitution pattern extends the longest zero series by a user-selectable number of additional zeros. The next bit following these zero-series will be forced to 1. Mark ratio is the ratio of ones and zeros in a PRBS stream, which is 1/2 in a normal PRBS. Variable mark ratio allows values of 1/8, 1/4, 1/2, 3/4, 7/8. Due to granularity reasons a PRBS has to be written to RAM several times, at a multiplexing factor of 128 the number of repetitions is also 128. That means that a  $2^{15} - 1$  PRBS uses up to 4 Mbit of the memory. Hardware-based PRBS can be any polynomial up to  $2^{31} - 1$ . No memory is used, so the total memory is free for memory-based pattern generation. Error insertion allows inserting single or multiple errors into a data stream. So instead of a '0' a '1' is generated and vice versa. Single errors can be inserted by pod or via instruction from the central sequencer. The user can trigger an error with a signal supplied to the qualifier pod of the central module. An error insertion with a fixed rate and a fixed distribution is

supported. The user software allows the selection of errored and error-free segments.

### Generator front end (E4862B)

The amplifier generates a differential output signal. Each output can be individually switched on and off. The output levels are sufficient to drive typical high-speed devices with interfaces like ECL, PECL, LVDS and DVI levels. The nominal output impedance is 50  $\Omega$ . The delay control In has a single-ended

input with 50  $\Omega$  impedance. The input voltage modulates a delay element within the generator's differential output. The user has the option of turning the delay control in feature on or off. Additionally the user can select between two delay ranges.

**Table 51. Parameters for generator front-ends E4862B 3.35 Gb/s**

<b>Outputs</b>	1, differential or single-ended	
<b>Impedance</b>	50 $\Omega$ typ.	
<b>Data formats</b>	Data: NRZ, DNRZ, RZ, R1	
<b>Pulse mode</b>		
Range	150 ps to (1UI - 150 ps)	
Sampling delay resolution	1 ps	
Width accuracy	40 ps typ.	
<b>Output voltage window</b>	-2.00 to +3.5 V	(1)
Ext. term. voltage	-2.00 to +3.5 V	(2)
<b>Absolute maximum external voltage</b>	-2.2 V to +3.2 V	
<b>Addressable technologies</b>	LVDS, CML, PECL, ECL low voltage CMOS	
<b>Amplitude/resolution</b>	0.05 Vpp ... 1.8 Vpp/10 mV	
<b>Accuracy hi level/amplitude</b>	$\pm 2\% \pm 10$ mV	
<b>Short circuit current</b>	72 mA max.	
<b>Transition times (20% - 80%)</b>	< 75 ps; 60 ps typ.	
<b>Overshoot/ringing</b>	5% +10 mV typ.	
<b>Jitter, NRZ data mode</b>	< 30 ps peak-peak	(3)
<b>Clock mode</b>	< 2 ps rms	(3 & 4)
<b>Pulse, RZ, R1 mode</b>	30ps peak-peak typ.	(3 & 4)
<b>Cross-point adjustment (Duty cycle distortion)</b>	30% ... 70% (in NRZ mode only)	

(1) For output voltages > 3 V the termination voltage  $\geq 3$  V needs to be applied.

(2) External termination voltage must be less than 3 V below VOH, and less than 3 V above VOL. Termination into AC is possible.

(3) Measured with E4808A clock module.

(4) Specified as intra channel jitter.

**Table 52. Delay control in**

<b>Input voltage window</b>	-500 mV to +500 mV (DC-coupled)
<b>Delay range 1</b>	-250 ps to +250 ps
<b>Delay range 2</b>	-25 ps to +25 ps
<b>Modulation bandwidth</b>	DC to 200 MHz
<b>Input impedance</b>	50 $\Omega$ (typ.)

## Analyzer front end (E4863B)

The analyzer features are:

- Acquire data from start
- Compare and acquire data around error
- Compare and count erroneous ones and zeros to calculate the bit error ratio

The receive memory for acquired data is up to 16 Mbit deep, depending on the segment length resolution. The stimulus portion of the channel generates expected data and mask data. Mask data is also available at the maximum granularity.

The analyzer is able to synchronize on a received data stream by means of a user-defined detect word. The detect word is defined by the first bits within the expected segment, it has a length of 48 bits and is composed of zeros, ones and Xs (“don’t cares”). The detect word must be unique within the data stream. Synchronization on a pure-PRBS data-stream is done without a detect-word, by simply loading a number of the incoming bits into the internal PRBS generator. A pre-condition for this is that the polynomial of the received PRBS is known.

The input comparator has differential inputs with 50  $\Omega$  impedance. The sensitivity is down to 50 mV and the common mode range of the comparator allows the testing of all common differential high-speed devices. The user has the option of using the differential input with or without a termination voltage or as single-ended input (with a termination voltage). The differential mode does not need a threshold voltage, whereas the single-ended mode does. But also in differential mode the user

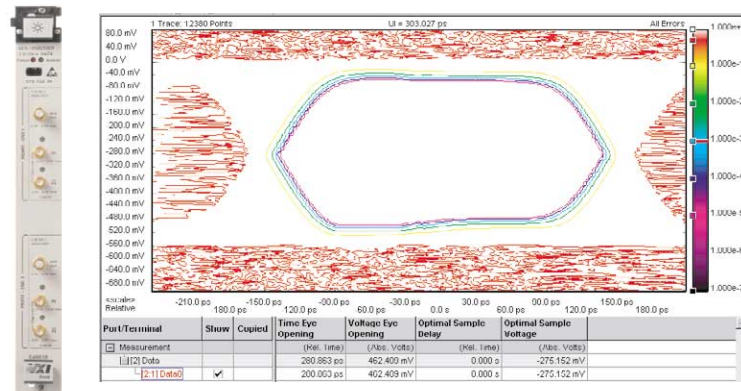

Figure 24. E4861B Data module and E4863B analyzer with eye diagram

Table 53. Parameters for analyzer front-ends E4863B 3.35 Gb/s

<b>Number of channels</b>	1, differential or single-ended
<b>Impedance</b>	50 $\Omega$ typ. (100 $\Omega$ differential if termination voltage is switched off)
<b>Internal termination voltage (can be switched off)</b>	-2.0 to +3.0 V
<b>Threshold voltage range</b>	-2.0 to +3.0 V
<b>Threshold resolution</b>	1 mV
<b>Threshold accuracy</b>	$\pm 20$ mV $\pm 1\%$
<b>Input sensitivity (single-ended and differential)</b>	< 50 mV
<b>Minimum detectable pulse width</b>	< 150 ps
<b>Maximum input voltage range</b>	Three ranges selectable: -2 V to +1 V -1 V to +2 V 0 V to 3 V
<b>Maximum differential voltage</b>	1.8 V
<b>Phase margin with ideal input signal</b>	> 1 UI - 30 ps (1)
<b>Phase margin with E4862B generator</b>	> 1 UI - 50 ps (1)
<b>Auxiliary out</b>	V out: 350 mV pp typ., AC coupled (2)
<b>Sampling delay resolution</b>	1 ps

- (1) Measured with E4808A central module  
(2) Terminate with 50  $\Omega$  to GND, if not used

can select one of the two inputs and compare the signal to a threshold voltage.

## Protection

Input and output relays switch off automatically, if the absolute maximum voltage window is exceeded.

## Typical waveform pictures

### Eye Plots

The 3.35 Gb/s generator output is designed for clean and fast output signals. It offers a swing of 50 mV to 1.8 V within the voltage window suited for testing LVDS, CML, (P)ECL and SSTL 0 - 3.3 V technologies.

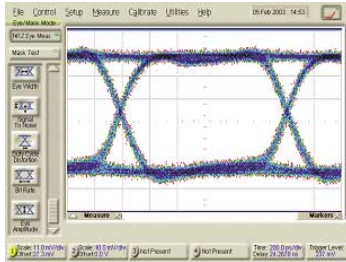

Figure 25a. 3.35 Gb/s Generator: 50 mVpp

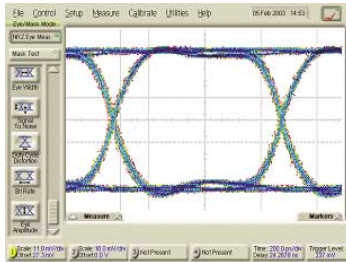

Figure 25b. 3.35 Gb/s Generator: 1.8 V pp

### Crossing Point

The 3.35 Gb/s generator allows a variable cross-over for differential signals. The cross-over can be programmed by the user interface or remote program between 30 and 70%.

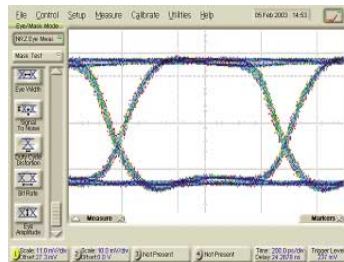

Figure 25c. 3.35 Gb/s Generator @30%

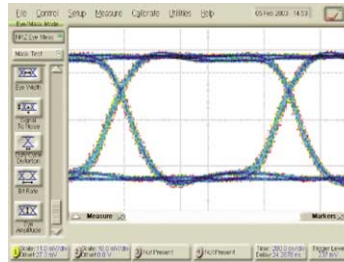

Figure 25d. 3.35 Gb/s Generator @70%

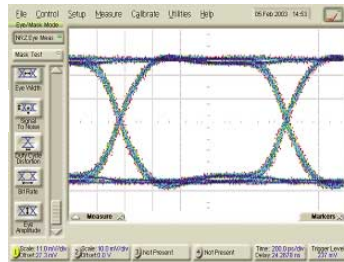

Figure 25e. 3.35 Gb/s Generator @50%

### Jitter Modulation Examples

The 3.35 Gb/s generator has a control input for modulating the delay with the help of an external signal. This modulation can be used to emulate jitter. The picture shows this modulation for different types of control voltages. The modulation can be used to test a DUT for jitter tolerance.

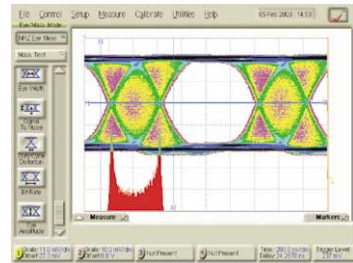

Figure 26a. Jitter modulated with sine wave

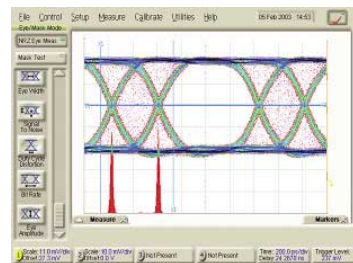

Figure 26b. Jitter modulated with rectangle wave

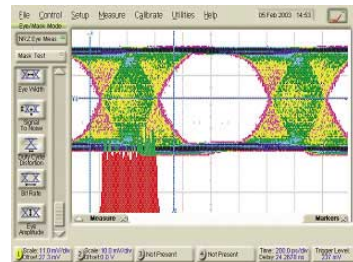

Figure 26c. Jitter modulated with triangle wave

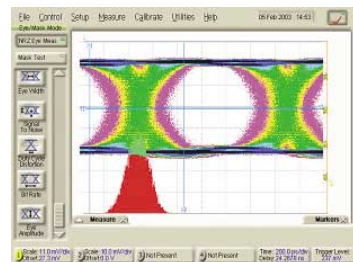

Figure 26d. Jitter modulated with noise generator

# Agilent E4861A ParBERT 2.7 Gb/s / 1.65 Gb/s Data Module

## Agilent E4862A ParBERT 2.7 Gb/s Generator Front-End

## Agilent E4863A ParBERT 2.7 Gb/s Analyzer Front-End

# Agilent E4864A ParBERT 1.65 Gb/s Generator Front-End

## Agilent E4865A ParBERT 1.65 Gb/s Analyzer Front-End

### Technical Specifications

#### E4861A generator/analyzer module

This module holds any combination of up to two analyzer front-ends (E4863A, E4865A) and generator front-ends (E4862A, E4864A).

With front-ends E4864A and E4865A the maximum speed is limited to 1.65 Gbit/s. The maximum speed of 2.7 Gbit/s is achieved with front-ends E4862A and E4863A.



Figure 27. E4861A module

#### Clock module/data mode

The generator can operate in clock mode or data mode. Clock mode is achieved when the generator is assigned as a pulse port. Data mode is achieved when using it as a data port. In Clock mode there is a fixed duty cycle of 50%. In data mode there is NRZ format with variable delay. The analyzer always works as data port with variable sampling delay. The sampling delay consists of two elements: the start delay and the fine delay. The fine delay can be varied within  $\pm 1$  period without stopping.

Table 54. E4861A data generator timing specifications (@ 50% of amplitude, 50  $\Omega$  to GND)

<b>Frequency range(1)</b>	Clock/data mode 333.334 Mb/s to 2.70 Gb/s (1.65 Gbit/s E4864A, E4865A)
<b>Delay (between channels)</b>	Can be specified as leading edge delay in fraction of bits in each channel
<b>Range</b>	0 to 300 ns (not limited by period)
<b>Resolution</b>	1 ps
<b>Accuracy</b>	$\pm 50$ ps $\pm 50$ ppm relative to the zero-delay placement. (From 20 °C to 35 °C without autocol)
<b>Skew between modules of same type</b>	$\pm 80$ ps $\pm 50$ ppm typ. relative to the zero-delay placement and temperature change within $\pm 5$ °C after autocalibration
<b>Pulse width</b>	50% of period typ. in clock mode

(1) See tables for front-end deratings

#### Data capabilities

PRBS/PRWS and memory-based data are defined by segments. Segments are assigned to a generator for a pattern stimulating. on an analyzer it defines the expected pattern which the incoming data are compared to. The expected pattern can be set up with mask bits.

The segment length resolution is the resolution to which the length of a pattern segment or mask can be set. The maximum memory per channel of the E4861A can be set in steps of 64 bits up to a length of 8192 kbits. If the 64 bit segment length resolution is too coarse, memory depth and frequency can be traded.

**Table 55. E4861A analyzer timing all timing parameters are measured at ECL and levels, terminated with 50 Ω to GND**

<b>Sample delay = start delay + fine delay</b> , fine delay can be changed without stopping	
<b>Sampling rate(1)</b>	Same as generator
<b>Fine delay range</b>	±1 period
<b>Sampling delay range</b>	Same as generator
<b>Accuracy</b>	Same as generator
<b>Resolution</b>	Same as generator
<b>Skew</b>	Same as generator

(1) See tables for front-end de-ratings

**Table 56: E4861A pattern and sequencing**

<b>Patterns:</b>	
<b>Memory based</b>	Up to 8 Mbit
<b>PRBS/PRWS</b>	$2^n - 1$ , n = 7, 9, 10, 11, 15, 23, 31
<b>Mark density</b>	1/8, 1/4, 1/2, 3/4, 7/8 at $2^n - 1$ , n = 7, 9, 10, 11, 15
<b>Errored PRBS/PRWS</b>	$2^n - 1$ , n = 7, 9, 10, 11, 15
<b>Extended ones or zeros</b>	$2^n - 1$ , n = 7, 9, 10, 11, 15
<b>Clock patterns</b>	Divide or multiply by 1, 2, 4
<b>User</b>	Data editor, file import
<b>Analyzer auto-synchronization:</b>	On PRBS or memory-based data manual or automatic by: Bit synchronization (2) with or without automatic phase alignment Automatic delay alignment around start sample delay (range: ±10 ns) BER threshold: $10^{-4}$ to $10^{-9}$

(2) Bit synchronization on data is achieved by detecting a 48 bit unique word at the beginning of the segment. "Don't cares" within the detect word are possible. In this mode no memory-based data can be sent within the same system. If several inputs synchronize, the delay difference between the terminals must be smaller than ±5 segment length resolution. Not supported for mark density, errored PRBS/PRWS and extended ones or zeroes patterns.

**Table 57. Data rate range, segment length resolution, available memory for synchronization and fine delay operation**

<b>Data rate range M/bits</b>	<b>Segment length resolution</b>	<b>Maximum memory depth, bits</b>
333.334...666.666	16 bits	2,097,152
666.667...1,333.333	32 bits	4,194,304
1,333.334...2,666.667	64 bits	8,388,608

In general it is possible to set higher values for the segment length resolution and also at lower frequencies than are indicated in the table.

**Table 58. Depending on the capability of generating PRWS and port width, almost all the combinations are possible except the following:**

<b>PRWS</b>	<b>Port width</b>
$2^7 - 1$	No restriction
$2^9 - 1$	7
$2^{10} - 1$	3, 11, 31, 33
$2^{11} - 1$	23
$2^{15} - 1$	7, 31
$2^{23} - 1$	47
$2^{31} - 1$	No restriction

## Sub-frequencies

For applications requiring different frequencies at a fraction of the system clock, the rate can be divided or multiplied by 1, 2 or 4. This influences the dependency between segment length resolution and maximum memory depth.

## Synchronization

Synchronization is the method of automatically adjusting the proper bit phase for data comparison on the incoming bit stream. The synchronization can be performed on PRBS/PRWS and memory-based data but it is not possible on a mix of PRxs and memory-based data.

There are two types of synchronization

- Bit synchronization
- Auto delay alignment

Bit synchronization is possible to cover a bit alignment for a totally unknown number of cycles. Using memory-based data, the first 48 bits within the expected data segment will work as detect word, which the incoming data is compared to. Analysis begins when the incoming data match the detect word.

Auto delay alignment is performed by using the analyzer sampling delay. The sampling delay range is ±10 ns.

Using auto delay, alignment provides synchronization with an absolute timing relation between a group of analyzer channels. So skew measurements are possible.

## Input/output

### Addressable technologies

LVDS, ECL (terminated with 50 to 0 V/-2 V), PECL (terminated to +3 V analyzer input requires use of a bias tee).

### Analyzer input

The analyzer channel can be operated:

- Single-ended normal
- Single-ended compliment
- Differential

For termination there is always 50  $\Omega$  connected to a programmable termination voltage. In differential mode there is an additional, selectable 100  $\Omega$  differential termination. Independent of the selected termination, there is the choice of whether the analysis of the incoming signal is performed on the input or true differential. For connecting to PECL it is recommended that a bias tee is used. The 2.7 Gb/s analyzer offers an auxiliary output, where the differential input signal is available as a single-ended signal. The bandwidth of the Aux output is limited to 2 GHz.

### Generator output

The generator output can be used as single-ended or differential. Enable/disable relays provide on/off switching. When switched off, internal termination is provided. It is recommended that unused outputs are either turned off or externally terminated.

The generator outputs can work into 50  $\Omega$  center tapped termination or 100  $\Omega$  differential termination. The proper termination scheme can be chosen from the editor to adapt proper level programming.

**Table 59. Parameters for analyzer front-ends E4863A 2.7 Gb/s (E4865A 1.65 Gb/s)**

<b>Number of channels</b>	1, differential or single ended
<b>Impedance</b>	50 $\Omega$ typ. 100 $\Omega$ differential if termination voltage is switched off
<b>Internal termination voltage (can be switched off)</b>	-2.0 to +3.0 V
<b>Threshold voltage range</b>	2.0 to + 3.0 V
<b>Threshold resolution</b>	2 mV
<b>Threshold accuracy</b>	$\pm 1\% \pm 20$ mV
<b>Input sensitivity (single-ended and differential)</b>	50 mV typ
<b>Minimum detectable pulse width</b>	180 ps typ. at ECL levels
<b>Maximum input voltage range</b>	Three ranges selectable: -2 V to + 1 V -1 V to +2 V 0 V to 3 V
<b>Maximum differential voltage</b>	1.8 V operating max. 3 V
<b>Delay resolution</b>	1 ps
<b>Phase margin, with ideal input signal with generator E4862A</b>	> 1 UI - 50 ps > 1 UI - 75 ps
<b>Auxiliary out</b>	Swing: 400 mV pp typ., AC coupled

**Table 60. Parameters for generator front-ends E4862A 2.7 Gb/s (E4864A 1.65 Gb/s)**

<b>Outputs</b>	1, differential or single ended
<b>Impedance</b>	50 $\Omega$ typ.
<b>Formats</b>	Clock: duty cycle 50% $\pm 10\%$ typ. Data: NRZ, DNRZ
<b>Output voltage window</b>	-2.00 to + 3.00 V 3.00 V to 4.5 (terminated to +3V only)
<b>Maximum external voltage</b>	- 2.2 to +4.7 V
<b>External termination voltage</b>	-2 V to +3 V
<b>Amplitude/resolution</b>	low voltage CMOS 0.05 to 1.8 Vpp (1) / 10 mV
<b>Accuracy hi level/amplitude</b>	$\pm 2\% \pm 10$ mV
<b>Short circuit current</b>	72 mA max
<b>Transition times (20% - 80%)</b>	90ps typ @ ECL,LVDS 110 ps typ @ Vpp max
<b>Overshooting/ringing</b>	20% + 20 mV typ
<b>Jitter, data mode</b>	< 50 ps peak-to-peak
<b>clock mode</b>	< 5 ps, rms

(1) Doubles into open, but outputs may switch off if outside limits

### Protection

Input and output relays switch off automatically if maximum voltages are about to be exceeded.

**Agilent E4832A ParBERT 675 Mb/s Data Module**  
**Agilent E4838A ParBERT 675 Mb/s Generator Front-End**  
**Agilent E4835A ParBERT 675 Mb/s Analyzer Front-End**

**Technical Specifications**

**E4832A 675 Mb/s generator/analyzer module**

This module holds any combination of up to two analyzer front-end pairs (E4835A) and four generator front-ends (E4838A).

**Clock module/data mode**

The generator can operate in clock mode or data mode. Clock mode is achieved when the generator is assigned as a pulse port. Data mode is achieved with assigning it to a data port. In clock mode it is a fixed duty cycle of 50%. In data mode it is NRZ format with variable delay. The analyzer only works as a data port whenever used with variable sampling delay. The sampling delay consists of two elements: the start delay and the fine delay. The fine delay can be varied within  $\pm 1$  period without stopping.

**Data capabilities**

PRBS/PRWS and memory-based data are defined by segments. Segments are assigned to a generator, and for stimulating a pattern. On an analyzer, it defines the expected pattern which the incoming data are compared to. The expected pattern can contain mask bits.

The segment length resolution is the resolution to which the length of a pattern segment can be set. The maximum memory per channel of the E4832A can be set in steps of 16 bits up to a length of 2048 Kbit. If the 16-bit segment length resolution is too coarse, memory depth and frequency can be traded.

**Sub-frequencies**

For applications requiring different frequencies at a fraction of the system clock, the ratio can be divided or multiplied by 2, 4, 8, or 16. This influences the dependency between segment length resolution and maximum memory depth.

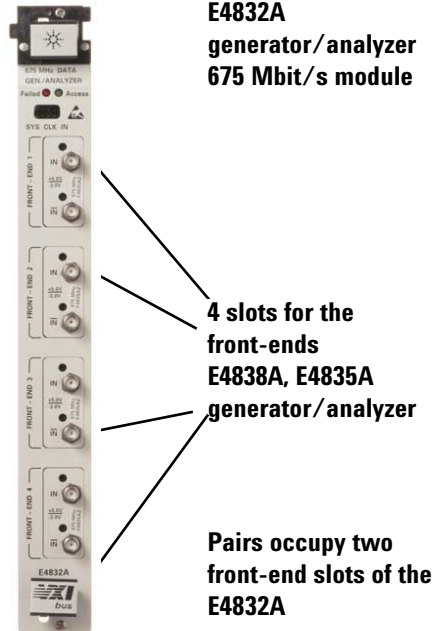

**Figure 28. E4832A module**

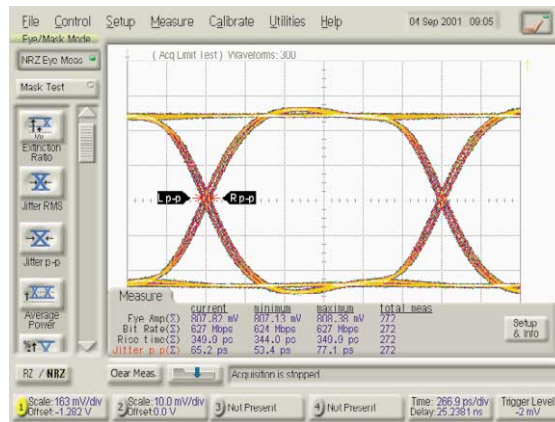

**Fig 29. Wave diagram of E4832A generator**



## Synchronization

Synchronization is the method of automatically adjusting the proper bit phase for data comparison on the incoming bit stream. The synchronization can be performed on PRBS/PRWS and memory-based data but it is not possible on a mix of PRxs and memory based data.

There are two types of synchronization:

- Bit synchronization
- Auto delay alignment

Bit synchronization is possible to cover a bit alignment for a totally unknown number of cycles. Using memory-based data, the first 48 bits within the expected data segment will work as a detect word which the incoming data are compared to. When the incoming data match with this detect word, analysis will begin.

Auto delay alignment is performed by using the analyzer sampling delay. The sampling delay range is  $\pm 50$  ns while this is possible.

Using auto delay alignment provides synchronization with an absolute timing relation between a group of analyzer channels. This makes skew measurements are possible.

**Table 61. E4832A data generator timing specifications (@ 50% of amplitude, 50  $\Omega$  to GND and fastest transition times)**

<b>Frequency range</b>	333,334 kHz to 675 MHz
<b>Delay range</b>	0 to 3.0 $\mu$ s (not limited by period)
Sampling delay resolution	2 ps
Accuracy	$\pm 50$ ps $\pm 50$ ppm relative to the zero-delay placement (1)
Skew	50 ps typ. after deskewing at customer levels
<b>Pulse width</b>	Can be specified as width or % of duty cycle
Range	750 ps to (period - 750 ps)
Resolution	2 ps
Accuracy	$\pm 200$ ps $\pm 0.1\%$
Duty cycle	1% to 99%, subject to width limits

(1) Valid at 15 to 35 °C room temperature

**Table 62. E4832A analyzer timing all timing parameters are measured at ECL and levels terminated with 50  $\Omega$  to GND**

<b>Sample delay = start delay + fine delay</b>	
Fine delay can be changed without stopping (2)	
<b>Sampling rate (3)</b>	333,334 Kb/s to 675 Mb/s
<b>Fine delay range</b>	$\pm 1$ period
<b>Sampling delay range</b>	0 to 3.0 $\mu$ s (not limited by period)
Accuracy	$\pm 50$ ps $\pm 50$ ppm relative to the zero-delay placement (3)
Resolution	2 ps
Skew	50 ps typ. after deskewing at customer levels

(2) Conditions: frequency > 20.8 MHz and by using the finest segment length resolution.

(3) See tables for front-end deratings

**Table 63. Pattern and sequencing features of E4832A**

<b>Patterns:</b>	
<b>Memory based</b>	Up to 2 Mbit
<b>PRBS/PRWS</b>	$2^n - 1$ , $n = 7, 9, 10, 11, 15, 23, 31$
<b>Mark density</b>	$1/8, 1/4, 1/2, 3/4, 7/8$ at $2^n - 1$ , $n = 7, 9, 10, 11, 15$
<b>Errored PRBS/PRWS</b>	$2^n - 1$ , $n = 7, 9, 10, 11, 15$
<b>Extended ones or zeros</b>	$2^n - 1$ , $n = 7, 9, 10, 11, 15$
<b>Clock patterns</b>	Divide or multiply by 1, 2, 4
<b>User</b>	Data editor, file import
<b>Analyzer auto-synchronization (2):</b>	On PRBS or memory-based data manual or automatic by: Bit synchronization (1) with or without automatic phase alignment Automatic delay alignment around start sample delay (range: $\pm 50$ ns) BER threshold: $10^{-4}$ to $10^{-9}$

(1) Bit synchronization on data is achieved by detecting a 48 bit unique word at the beginning of the segment. "Don't cares" within the detect word are possible. In this mode no memory-based data can be sent within the same system. If several inputs synchronize, the delay difference between the terminals must be  $\pm 5$  segment length resolution.

(2) Condition: frequency > 20.8 MHz and by using the finest segment length resolution.

**Table 64. Data rate range, segment length resolution, available memory for synchronization and fine delay operation**

<b>Data rate range Mb/s</b>	<b>Segment length</b>	<b>Maximum memory resolution depth, bits</b>
20.834 ... 41.666	1 bit	131,008
41.667 ... 83.333	2 bits	262,016
83.334 ... 166.666	4 bits	524,032
166.667 ... 333.333	8 bits	1,048,064
333.334 ... 666.667	16 bits	2,097,152

In general, it is possible to set higher values for the segment length resolution and also at lower frequencies than are indicated in the table. In this case the fine delay function and the auto-synchronization function are unavailable.

**Table 65. Depending between the capability of generating PRWS and port width, almost all the combinations are possible except the following:**

<b>PRWS</b>	<b>Port width</b>
$2^7 - 1$	No restriction
$2^9 - 1$	7
$2^{10} - 1$	3, 11, 31, 33
$2^{11} - 1$	23
$2^{15} - 1$	7, 31
$2^{23} - 1$	47
$2^{31} - 1$	No restriction

## Input/output

### Addressable technologies

LVDS, (P)ECL, TTL, 3.3 V CMOS

### Analyzer input

The analyzer channel can be operated:

- Single-ended normal
- Single-ended compliment
- Differential

For termination there is always 50  $\Omega$  connected to a programmable termination voltage. In differential mode there is an additional, selectable 100  $\Omega$  differential termination. Independent of the selected termination, there is the choice of whether the analysis of the incoming signal is performed on the input or true differential.

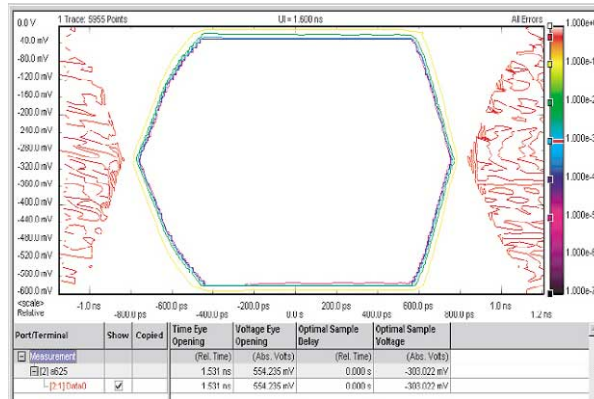

Fig 30. Eye diagram of E4835A analyzer

Table 66. Level parameters for differential generator front-end E4838A 675 Mb/s

Number of channels	1, differential
Impedance	50 $\Omega$ typ.
Data formats	RZ, R1, NRZ, DNRZ
Output voltage window	-2.2 to +4.4 V (doubles into open up to max. 5 Vpp)
Amplitude/resolution	0.1 V to 3.50 V / 10 mV
Level accuracy	$\pm 3\% \pm 25$ mV typ. after 5 ns settling time
@ LVDS/(P)ECL	$\pm 1\% \pm 25$ mV typ. after 5 ns settling time
Variable transition time range (10 - 90% of amplitude)	0.5 to 4.5 ns
Accuracy	$\pm 5\% \pm 100$ ps
@ LVDS/(P)ECL (20 - 80% of amplitude)	0.35 ns typ
Overshoot/ringing	< 7% (< 5% typ).
Jitter	
Data mode	< 100 ps peak to peak (80 ps typ)
Clock mode	8 ps rms typ.
Channel addition	XOR and analog

Table 67. Two differential analyzer front-ends E4835A (1), 667 MSa/s

Number of channels	2, differential or single-ended (switchable)
Impedance	50 $\Omega$ typ. 100 $\Omega$ differential if termination voltage is switched off
Termination voltage (can be switched off)	-2.0 to +3.0 V
Threshold voltage range/threshold accuracy	-2.00 to +4.50 V/ $\pm 1\% \pm 20$ mV
Threshold resolution	2 mV
Input sensitivity	Differential 50 mV typ Single-ended 100 mV typ
Minimum detectable pulsewidth	400 ps typ. at ECL levels
Input voltage range	Two ranges selectable: 0 to +5 V and -2 to +3 V
Phase margin with ideal input signal with E4838A generator	> 1 UI - 100 ps > 1 UI - 180 ps

(1) Occupy two front-end slots of the E4832A. The E4835A contains two front-ends (E4835AZ) and one common data back end. In this document one front-end is referred to as E4835A.

# Agilent ParBERT 81250

## Agilent E4809A 13.5 GHz Central Clock Module

## Agilent E4808A High Performance Central Clock Module

## Agilent E4805B 675 MHz Central Clock Module

### Technical Specifications

Each ParBERT 81250 system consists of at least one clock module, which generates the system clock for at least one generator or analyzer or any mix. Please see the table to the right for a complete compatibility overview.

#### Sequencing

The sequencing can be used to specify the data flow:

- Single
- Looped
- Infinite loop
- Event handling (branch)
- Synchronization

#### Event handling

With event handling, the flow of data generation and analysis can be controlled with external signals at run time.

#### Usage of events

- Start and stop of data
- Match loop
- Integration with other equipment (ATE)
- Trigger on error

<b>Table 68. Modules/central clock</b>	<b>E4805B</b>	<b>E4808A</b>	<b>E4809A</b>
E4832A - ParBERT 675 Mb/s	•	•	•
E4861A - ParBERT 2.7/1.6 Gb/s	•	•	
E4861B - ParBERT 3.35 Gb/s		•	•
E4810A/11A - ParBERT 3.3.5 Gb/s optical		•	
E4866A/67A - ParBERT 10.8 Gb/s		•	
N4872A/73A - ParBERT 13.5 Gb/s			•
E4868B/69B - ParBERT 45 Gb/s		•	
E4874A/75A - ParBERT 7 Gb/s			•

**Table 69. E4809A, E4808A and E4805B sequencing features**

<b>Number of segments</b>	1 to 30 (every segment looped once) 1 to 60 (no segment looped)
<b>Looping levels</b>	Up to 4 nested loops plus one optional infinite loop Loops can be set independently from 1 to 2 <sup>20</sup> repetitions
<b>Start/stop</b>	External input, manual, programmed (stop with E4832A only)
<b>Event handling</b>	React on internal and external events.

**Table 70. E4809A, E4808A and E4805B event handling**

<b>Event trigger sources</b>
Events can be defined as any combination of the following sources. A maximum of 10 events can be defined.
• 8-line trigger input pod for TTL signals
• VXI trigger lines T0 and T1
• Any capture error/or no error detected by one of the analyzer channels
• Software command control: an event trigger command issued locally or remotely
<b>Reactions to an event</b> can be set per data segment immediately or deferred and can be any combination of:
• Data segment jump
• Launch trigger pulse at trigger output of the clock module
• VXI trigger lines T0 and T1 can be set to 01, 10 or 11

**Master slave, multi-mainframe, different clock groups**

Up to 3 clock modules can be combined to run in one clock grouping by connecting the master slave cable. This is used to combine channels which do not fit into one frame into one clock group. Omitting the master-slave connection will run the channels as separate clock groups. A system can be a combination of multiple clock groups made up of multiple channels. The frequencies used can be totally asynchronous or m/n ratio (see clock input multiplier/divider). For separated clock groups the master slave is not used. Within one system the modules must be the same type.

**Table 71. E4809A, E4808A and E4805B trigger pod characteristics**

<b>Input lines</b>	8, single-ended	
<b>Input levels</b>	TTL compatible	
<b>Input threshold</b>	1.5 V	
<b>Input termination</b>	5k Ω pullup to +5 V	
<b>Absolute max ratings for</b>		
<b>input voltages</b>	-1.2 V to + 7.0 V	
<b>Cable delay</b>	11 ns typical	
<b>sampling clock frequency</b>	system frequency/segment length resolution	
<b>Setup time (1)</b>	TRIGGER OUTPUT	CLOCK/REF INPUT
	2.5 ns	-12.5 ns
<b>Hold time (1)</b>	5 ns	20 ns

(1) Includes the cable delay

**E4809A 13.5 GHz central clock module**

**General**

E4809A is a 2-slot central clock module with 13GHz clock distribution. ParBERT 81250 13.5 Gb/s modules are designed to run with the E4809A 13.5 GHz central clock module.

**Table 72. E4809A clock module specifications**

<b>Frequency range</b>	20.834 MHz...13.5 GHz	
<b>Resolution</b>	1 Hz	
<b>SSB phase noise (at 10 kHz offset)</b>	< -75 dBc at 10 GHz	
<b>Latency external start input</b>		
• Start IN to Trig OUT with 7/13.5 Gb/s	16 ns + (2 * system clock * segment resolution) ± 1 clock	(1)
• Start IN to Data OUT with 7/13.5 Gb/s	416 ns + (2 * system clock * segment resolution) ± 1 clock	(1)
• IN to Trig OUT without 7/13.5 Gb/s	16 ns ± 1 clock	(1)
• IN to Data OUT without 7/13.5 Gb/s	48 ns ± 1 clock	(1)

(1) Add 3 ns if expander frame is used

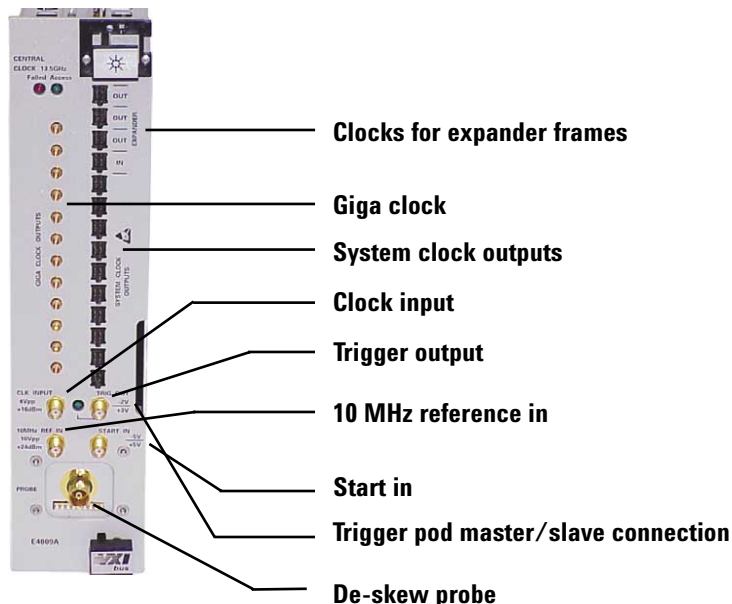

**Figure 31. E4809A module**

## Timing capabilities

The E4809A supports three different operation modes.

### E4809A as system clock

The E4809A distributes clock signals to connected modules in the range from 20.834 MHz up to 13.5 GHz. The E4809A provides Giga-clock signals in a range from 500 MHz up to 13.5 GHz to the ParBERT 81250 13.5 Gb/s modules (N4872A, N4873A). All other supported modules work using the E4809A master clock.

### External clock mode

The system will run synchronously to an external clock, which is connected to the clock module's clock input. There are two different sub-modes available. In the **direct** clock mode, the PLL (phase locked loop) is bypassed and an external clock signal can be distributed to all Giga-clock connected modules. This direct external clock mode operates in a range from 500 MHz to 13.5 GHz. In this mode the external clock may be FM or PM modulated. In the **indirect** external clock mode, the clock modules' internal PLL is used to generate flexible master clock and Giga-clock signals.

### Clock data recovery (CDR) mode

If the CDR is used, the CDR out of the analyzer must be connected to the clock input of the clock module.

## Start input

A sequence of generated data can be started by an external signal.

**Table 73. Start input**

<b>Start input</b>	DC coupled; 3.5 mm (f)
<b>Threshold range</b>	-1.40 V to +3.70 V
<b>Zin/termination voltage</b>	50 $\Omega$ typ./-2 V to +3 V
<b>Sensitivity/max. levels</b>	200 mVpp / -3 V...+6 V

## Reference input

The reference input allows ParBERT to run synchronously with an external 10 MHz clock. A continuous clock is necessary. A burst clock can not be used as an external clock.

**Table 74. Reference input**

<b>Reference input</b>	AC coupled; 3.5 mm(f)
<b>Frequency</b>	10 MHz
<b>Input transition time</b>	< 20 ns
<b>Required duty cycle</b>	50% $\pm$ 10
<b>Input impedance</b>	50 $\Omega$
<b>Sensitivity</b>	200 mVpp
<b>Required input phase noise</b>	< -137 dBc @ 10 MHz offset

## Clock input

This input runs ParBERT synchronously with an external clock. Usage of a continuous clock is necessary. A burst clock can not be used as an external clock. Two modes are selectable: Indirect external clock mode (clock module PLL is used) and Direct external clock mode (clock module is bypassed).

## Trigger output

The trigger output is used to deliver a trigger signal to a DUT, a digital communication analyzer (Agilent 86100A/B/C Series) or as a stimulus for the analyzer de-skew.

**Table 75: Clock input**

<b>Clock input</b>	AC coupled; 3.5 mm (f)
<b>Frequency range</b>	
<b>Indirect mode</b>	20.834 MHz...13.5 GHz
<b>Direct mode</b>	620 MHz...13.5 GHz
<b>Clock input (indirect mode only)</b>	m = 1...256; n = 1...256
<b>Multiplier(m)/divider(n)</b>	m x n <= 1024; clock >= 5 MHz
<b>Input transition/slope</b>	30 ps typ.
<b>Zin</b>	50 Ω
<b>Sensitivity</b>	< 150 mV
<b>Required input phase noise</b>	< 75 - 20 log (13.5 GHz / input frequency) dBc / Hz

**Table 76. Trigger output**

<b>Trigger output</b>	DC coupled, SMA (f)
<b>Frequency</b>	Up to 675 MHz
<b>Output transition/slope</b>	70 ps typ. 10/90
<b>Zout/termination voltage</b>	50 Ω/-2 to +3 V
<b>Output voltage window</b>	-2 V to +3 V
<b>Output level</b>	0.1 to 1.8 Vpp

## E4805B and E4808A central clock modules

The central clock module includes a PLL (phase-locked loop) frequency generator to provide a system clock. Depending on the frequency chosen, the data modules can be clocked at a ratio of 1, 2, 4, 8, 16, 32, 64 or 256 times higher or lower than the system clock.

**External start/stop:** The data can be started by an external signal applied to the external input. When using the E4832A module, a stop mode and a gate mode is also available.

**Ext. clock/ext. reference:** This input runs ParBERT 81250 synchronously with an ext. clock, or when a more accurate reference is needed than the internal oscillator. A continuous clock is necessary. A burst clock cannot be used as an external clock. Maximum external clock is 2.7 GHz for the E4805B and 10.8 Gb/s for the E4808A. (Note: no improvement of jitter specifications will be achieved with an external clock).

**Guided de-skew:** Individual semi-automatic deskew per channel is available. The 15447A deskew probe 15447A allows deskew on the DUT's (device under test) fixture.

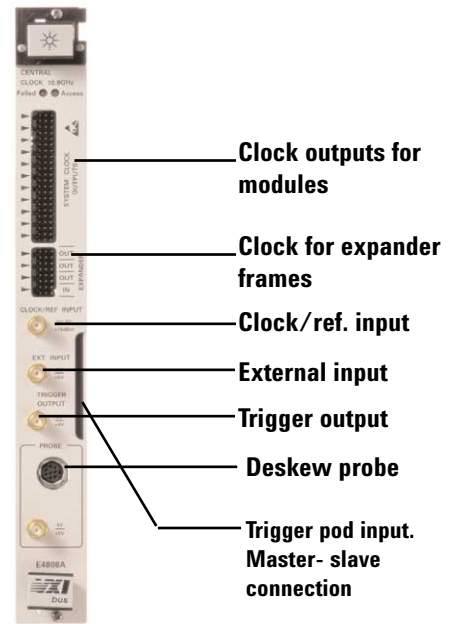

Figure 32: Clock module

Table 77. E4805B and E4808A clock module specifications

	E4805B	E4808A
<b>Frequency range (1) (can be entered as period or frequency)</b>	1 kHz to 675 MHz	170 kHz to 675 MHz
<b>will run with</b>	<ul style="list-style-type: none"> <li>E4861A in range of 334 MHz to 2.7GHz</li> <li>E4832A in range of 334 KHZ to 675 MHz</li> </ul>	<ul style="list-style-type: none"> <li>E4866A/E4867A in range of 9.5 GHz to 10.8 GHz</li> <li>E4861B in range of 20.834 MHz to 3.35 GHz</li> <li>E4861A in range of 334 MHz to 2.7 GHz</li> <li>E4832A in range of 334 KHZ to 675 MHz</li> </ul>
<b>Resolution</b>	1 Hz	1 Hz
<b>Accuracy</b>	±50 ppm with internal PLL reference	±50 ppm with internal PLL reference

(1) May be limited or enhanced by modules or frontends

Table 78. External input and ext. clock/ext. ref. input

	E4805B	E4808A
<b>Zin/termination voltage</b>	50 Ω /-2.10 V to 3.30 V	50 Ω /-2.10 V to 3.30 V
<b>Sensitivity/max levels</b>	400 mVpp/-3 V to + 6 V	200 mVpp/-3 V to + 6V for < 9.5 Gbit/s 300 mVpp/-3 V to+ 6 V for > 9.5 Gb/s
<b>Coupling</b>	dc,	dc,
<b>Ext. input:</b>	Threshold range: -1.40 V to +3.70 V	-1.40 V to +3.70 V
<b>Ext. clock/ext. ref:</b>	ac	ac
<b>Input transitions/slope</b>	< 20 ns. ext. input active edge is selectable	< 20 ns. ext. input active edge is selectable
<b>Clock input multiplier(m)/divider (n)</b>	m = 1...256; n = 1...256 m*n <= 1024 m/n * input frequency must fit data range input frequency/n >= 1.3 MHz	
<b>PLL lock time</b>	100 ms	100 ms
<b>Input frequency/period</b>		
<b>Ext. clock</b>	170 kHz - 2.7 GHz	170 kHz - 10.8 GHz
<b>Ext. ref</b>	1(1), 2(1), 5, or 10 MHz	1(1), 2(1), 5, or 10 MHz
<b>Required duty cycle</b>	50 ±10 %	50 ±10 %
<b>Latency (typical):</b>	to trigger output	to trigger output
<b>Ext. input</b>	16ns ±1 clock	16 ns ±1 clock
	to channel output	to channel output
	46ns ±1 clock	46 ns ±1 clock(2)
<b>Ext. clock</b>	15 ns	15 ns
	45 ns	45 ns
	Add 3 ns if an expander frame is used	Add 3 ns if an expander frame is used

(1) Jitter performance may be degraded

(2) If frequency = 667 MHz



### Trigger output

Can be used in:

- Clock mode
- Sequence mode

In sequence mode a pulse will be set to mark the start of any segment.

In clock mode, the trigger output can supply a clock output of up to 675 MHz. If a higher speed performance clock is needed:

- A 2.7 Gb/s generator can be used to supply a clock output up to 2.7 GHz
- A 10.8 Gb/s generator can be used to supply a clock output up to 10.8 GHz.

#### Technical specifications

All specifications describe the instrument's warranted performance. Non-warranted values are described as typical. All specifications are valid from 10° to 40° ambient temperature after a 30 minute warm-up phase, with outputs and inputs terminated with 50 Ω to ground at ECL levels unless specified otherwise.

**Table 79. Trigger output characteristics E4805B and E4808A**

<b>Trigger output signals</b>	• Clock mode (up to 675 MHz). • Sequence mode
<b>Output impedance</b>	50 Ω typ.
<b>Output level</b>	TTL (frequency < 180 MHz), 50 Ω to GND ECL 50 Ω to GND/-2 V, PECL 50 Ω +3 V
<b>Trigger advance</b>	30 ns typ. between trigger output and data output /sampling point (delay set to zero in both cases)
<b>Maximum ext voltage</b>	-2 V to +3.3 V
<b>Jitter (int. reference/int. clock)</b>	< 10 ps rms (5 ps typ.)

# General Characteristics

**Mainframes:** See table on page 52.

**Save/recall:** Pattern segments, settings and complete settings plus segments can be saved and recalled. The number of settings that can be stored is limited only by disk space.

**Vector import/export:** Pattern files can be imported/exported via a 3.5 inch floppy disk, LAN or GPIB (IEEE 488.2). File format is ASCII using a STIL subset.

**Programming interface:** GP-IB (IEEE 488.2) and LAN. The interface to applications such as C, Visual Basic, or VEE must be installed. Use the Agilent 81200 *Plug&Play* drivers for easy programming.

**Programming language:**  
SCPI 1992.0

**Programming times:** Vector transfer from memory to hardware depends on the amount of data. See the table for examples.

**On-line help:** Context-sensitive.

**Print-on-demand:** Getting started and programming guides can be printed from .pdf files included in the ParBERT 81250 software.

**Self-test:** Module and system selftests can be initiated.

## Modules

**Module size:**  
VXI C-size, 1 slot.

**Module type:**  
Register-based; requires ParBERT 81250 user software E4875A supplied with the mainframes.

**Weight:**  
(including front-ends) Net: 2kg.

**Shipping:** 2.5 kg.

**Warranty:**  
1 year return to Agilent

**Re-calibration period:** 1 year.

## Agilent Technologies quality standards

The ParBERT 81250 is produced to the ISO 9001 international quality system standard as part of Agilent Technologies' commitment to continually increasing customer satisfaction through improved quality control.

**Table 80. Programming times**

	Programming time
<b>Change of levels</b>	6 ms typ.
<b>Change of delay</b>	16 ms typ. Not applicable in run mode
<b>Change of period</b>	60 ms typ. For one E4805 with one E4832A. Not applicable in run mode. Increases with the number of modules but
<b>Stop &amp; start</b>	32 ms typ.
<b>Synchronization</b>	50 ms typ. (without phase alignment) 110 ms typ. with 20% phase accuracy @ 660 MHz 650 ms typ. with 1% phase accuracy @ 660 MHz

## Download values

System with 4 channels	< 1.5 s typ. 1000,000 bit each
System with 120 channels	< 20 s typ. 1 Mbit each
System with 40 channels	< 10 s typ. 1 Mbit each
+ Add numbers for each synchronizing analyzer within one module	

**Table 81: Cooling requirements for modules with front-ends installed**

Modules	$\Delta P$ mm H2O	Air flow liter/s	Max $\Delta$ temp
E4805B	0.25	3.6	10 °C
E4808A	0.25	3.6	10 °C
E4809A	1.08	3.7	12 °C
E4832A	0.30	4.7	15 °C
E4861A	0.40	5.2	10 °C
E4861B	0.40	6.6	15 °C
E4866A	0.30	5.2	10 °C
E4867A	0.30	5.5	15 °C
N4872A/74A	1.20	7.5	13 °C
N4873A/75A	0.85	5.4	12 °C

**Table 82. Power Requirements of Modules and Front-Ends**

	DC Volts	+24V	+12V	+5V	-2V	-5.2V	-12V	-24V
<b>Modules (These specifications are valid for the module with the front-ends installed)</b>								
<b>E4805B Central</b>	DC Current	0.15A	0.2A	1.8A	1.4A	3.8A	0.2A	-
<b>Clock module</b>	Dynamic current	0.015A	0.02A	0.18A	0.14A	0.38A	0.02A	-
<b>E4808A</b>	DC Current	0.2A	0.3 A.	1.8A	1.9A	3.9A	0.2A	-
	Dynamic current	0.02A	0.03A	0.18A	0.19A	0.39A	0.02A	-
<b>E4809A</b>	DC Current	0.35A	1.25 A	2.0A	2.4A	6.8A	0.5A	0.55
	Dynamic current	0.05A	0.15A	0.2A	0.3A	0.7A	0.05A	0.06
<b>N4872A/74A</b>	DC Current	0.5A	0.75A	3.8A	0.6A	2.6A	1.2A	0.8
	Dynamic current	0.05A	0.08A	0.38A	0.06A	0.26A	0.12A	0.08
<b>N4873A/75A</b>	DC Current	0.2A	0.5A	4.6A	0.7A	2.3A	0.3A	0.7
	Dynamic current	0.02A	0.05A	0.46A	0.07A	0.23A	0.03A	0.07
<b>E4866A</b>	DC Current	0.2A	1.0A	5.0A	1.2A	2.6A	0.5A	0.9
	Dynamic Current	0.02A	0.1A	0.5A	0.12A	0.26A	0.05A	0.09
<b>E4867A</b>	DC Current	0.2A	1.0A	7.0A	1.5A	3.0A	0.8A	0.2
	Dynamic current	0.02A	0.1A	0.7A	0.15A	0.3A	0.08A	0.02
<b>E4861B</b>	DC Current	0.02A	0.03A	2.2A	0.4A	0.4A	-	-
	Dynamic current	0.01A	0.01A	0.2A	0.04A	0.04A	-	-
<b>E4862B Generator</b>	DC Current	0.2A	0.2A	1.0A	0.2A	0.5A	0.21A	0.48
	Dynamic Current	0.02A	0.02A	0.07A	0.02A	0.05A	0.02A	0.05
<b>E4863B Analyzer</b>	DC Current	0.2A	0.2A	2.0A	0.2A	0.45A	0.21A	0.48
	Dynamic Current	0.02A	0.02A	0.2A	0.02A	0.05A	0.02A	0.05
<b>E4861A 2.7 Gb/s</b>	DC Current	0.10	0.50A	5.20A	1.80A	4.00A	0.90A	0.01
<b>Gen./An.Module</b>	Dynamic current	0.01A	0.05A	0.52A	0.18A	0.40A	0.09A	-
<i>Remark: The power requirements of E4861A include the power requirements of any two front ends</i>								
<b>E4832A 675 Mb/s</b>	DC Current	0.10A	0.10A	2.60A	0.60A	3.60A	0.10A	0.1
<b>Gen./An. Module</b>	Dynamic Current	0.01A	0.01A	0.26A	0.06A	0.36A	0.01A	0.01
<i>Remark: For the module E4832A, the power specifications of the chosen front-ends (E4835A, E4838A or E4843A) have to be added to the power specifications of the E4832A module to get the overall value of the power specifications</i>								
<b>E4838A</b>	DC Current		0.45A	0.18A	0.07A	0.38A	0.41A	-
<b>Differential</b>	Dynamic Current		0.045A	0.018A	0.007A	0.038A	0.041A	-
<b>Generator 675 Mb/s</b>								
<b>Front-ends</b>								
<b>E4835A two differential</b>	DC Current		0.2A	1.2A	0.2A	0.3 A	0.3A	-
<b>Analyzer 675 Mb/s</b>	Dynamic Current		0.02A	0.12A	0.02A	0.03A	0.03A	-

**Table 83. General mainframe characteristics**

---

<b>Description</b>	81250A mainframe
<b>Order description</b>	E8403A 13 slot VXI C-size frame 81250A-149 (entry frame) 81250A-152 (expander frame) E8404A-148
<b>Number of slots for ParBERT</b>	
<b>81250 data/clock modules</b>	12
<b>Operating temperature</b>	10 °C to 40 °C
<b>Storage temperature</b>	-20 °C to +60 °C
<b>Humidity</b>	80% rel. humidity at 40 °C
<b>Power requirements</b>	90 - 264 Vac ± 10%, 47 - 66 Hz 90 - 264 Vac ± 10%, 300 - 440 Hz (not recommended: leakage current may exceed safety limits @ > 132 Vac)
<b>Power available for modules</b>	950 W for 90 - 110 Vac supplies 1000 W for 110 - 264 Vac supplies
<b>Electromagnetic compatibility</b>	EN 55011/CISPR 11 group 1, class A + 26 dB
<b>Acoustic noise</b>	48 (56) dBA sound pressure at low (high fan speed)
<b>Safety</b>	IEC 348, UL 1244, CSA 22.2 #231, CE-mark
<b>Physical dimensions</b>	W: 424.5 mm, 16.71 inches H: 352 mm, 13.85 inches D: 631 mm, 24.84 inches
<b>Weight (net)</b>	26.8 kg (25.3 kg)
<b>Weight (shipping) (max.)</b>	72 kg (67 kg)

---

## Quick ordering guide - overview

The ParBERT 81250 is a modular instrument, which can be tailored to your specific needs. There are generator and analyzer channels at different speed classes. The ParBERT 81250 channels consist of data modules and front-ends. The 13.5 Gb/s, 10.8 Gb/s, 7 Gb/s and 3.35 Gb/s optical are dedicated data modules for generators and analyzers. At 3.35 Gb/s and 2.7 Gb/s the data module houses 2 front-ends, at 675 Mb/s the data module houses 4 front-ends. The data modules operate in conjunction with a clock module. The combination of data modules with a clock module is called 'clock group' and is represented in the ParBERT 81250 software within one user interface. The following table lists the combination of data modules and front-ends together with usable clock modules.

**Table 84. Ordering guide**

Data module/front-ends		Generator	Analyzer	Clock module
13.5 Gb/s data module		N4872B	N4873	E4809A
10 Gb/s data module		E4866A	E4867A	E4808A
7 Gb/s data module		N4874A	N4875A	E4809A
3.35 Gb/s data module	(1)	E4861B	E4861B	E4808A
3.35 Gb/s front-end		E4862B	E4863B	or E4809A
2.7 Gb/s/1.65 Gb/s data module	(1)	E4861A	E4861A	E4805B
2.7 Gb/s/1.65 Gb/s front-end		E4862A/E4864A	E4863A/E4865A	or E4808A
675 MHz data module	(2)	E4832A	E4832A	E4805B
675 MHz front-end	(3)	E4838A	E4835A	or E4808A or E4809A

- (1) Houses 2 front-ends  
 (2) Houses 4 front-ends  
 (3) E4835A provides a pair of analyzers

### Entry system

The VXI frame offers 13 slots. Besides data modules and clock modules, there is the need for a computer interface. The ParBERT 81250 works with an IEEE 1394 FireWire interface, which works with an external PC (81250 #013, #014) or a laptop (81250 #015). The IEEE 1394 FireWire card consumes one VXI slot. Assuming the use of the Firewire interface and one clock module in place, the entry system can hold up to:

- 10 channels at 13.5 Gb/s, 7 Gb/s
- 11 channels at 10.8 Gb/s and 3.35 Gb/s optical
- 22 channels at 3.35 Gb/s or 2.7 Gb/s
- 44 channels at 675 Mb/s.

In some circumstances these maximum numbers cannot be achieved due to power restrictions. Before finalizing a configuration, it is necessary to calculate the power budget. The 675 Mb/s Analyzer E4835A always comes as a pair and need to be configured side by side, providing two fully independent analyzer channels.

**Table 85. Entry system**

Max # of channels	3.35 Gb/s or 675 Mbits	13.5 Gb/s 2.7 Gb/s or 1.65 Gb/s	10.8 Gb/s	7 Gb/s
<b>FireWire</b>				
1 frame	44	22	11	10
2 frames	88	44	22	20
3 frames	132	66	33	30
4 frames	176	88	44	40

**More than 3 frames require more than one clock group.**

## Multi-mainframe/master-slave

If the number of channels exceeds the number of available slots in the “entry” frame, it is possible to add expander frames. To add channels within one clock group, there is the limit of a maximum of two expander frames. If data modules are housed in an expander frame they need an additional clock module. This clock module must be connected to the clock module in the entry frame (master frame) with the help of the master-slave connection. This connection carries the clock and data flow synchronization between the frames. The master-slave connection hardware is delivered with the expander frames. The master-slave connection is only possible between clock modules of the same type.

Aside from the master-slave connection between the clock modules, the controller interface also needs an extension into the expander frames:

- The FireWire interface, consuming one slot, can be “daisy-chained” from frame to frame. This would allow the configuration of a ParBERT 81250 system with virtually an unlimited number of channels (within different clock groups, see above limitation of max. channels per clock group).

## Different clock groups

A clock group consists of a clock module, one or more data modules and the graphical user interface to set the parameters. Within one clock group there can be data modules with generators and analyzer front-ends from different speed classes combined using the binary frequency multipliers (... , 1/16, 1/8, 1/4, 1/2, 1, 2, 4, 8, 16, ...) the data rate range possible for each data module can be achieved. The configuration of more than one clock group is possible. This will combine a clock module with one or more data modules. Several clock groups may be housed in one frame or using expander frames. Each clock group will be operated from its own graphical user interface. The user interface will actually be assigned to a certain hardware set. If there is more than one clock group, the user interfaces may run from separate PCs, connected via LAN. A configuration of more than one clock group is recommended:

- To run different speeds (non binary ratio) between generators and/or analyzers
- To run independent phase ratio between generators and/or analyzers
- To make flexible use of data rate range when combining different speed classes
- To use custom (memory) based data and use of bit synchronization for the analyzer(s).

Using different clock groups reduces the maximum number of channels given in the table on the previous page. Within one system using different clock groups, all clock modules must be of the same type. A master-slave connection must not be installed between the clock modules if different clock groups are desired.

### Order information entry system

1 x 81250A                      System reference  
1 x 81250-149                  Mainframe  
1 x E4805B/E4808A/  
E4809A                          1st clock module

### Add data modules/front-ends

#### Decide on controller:

1 x 81250A-013                FireWire (IEEE 1394) PC Link to VXI  
1 x 81250A-014                Ext. PC  
or  
1 x 81250A-015                Laptop including PCMCIA IEEE 1394 card

#### Decide on controller accessories:

1 x 15444A                      Monitor  
1 x 15445A                      Ext. CD-ROM

### Order information multi mainframe:

1 x 81250-152                FireWire (IEEE 1394) expander frame  
1 x E4805B/E4808A/  
Clock module

### E4809A

#### Add data modules/front-ends

### Order information master-slave/different clock groups

E4805B:                        Clock module (usable with 675Mb/s and 2.7 Gb/s module)  
E4808A:                        Clock module (usable with 675 Mb/s, 1.65 Gb/s, 2.7 Gb/s,  
3.35 Gb/s, 10.8 Gb/s and 45 Gb/s modules)  
E4809A:                        Clock module (usable with 675 Mb/s, 3.35 Gb/s, 7 Gb/s and  
13.5 Gb/s modules)

#### Specific rules:

- Do not mix E4809A, E4808A and E4805B:
- Slave connection is possible only between clock modules of the same type
  - One system must be configured with one type of clock module

**Table 86. Cable kit accessories**

P/N description	Cable kit	No. of cables	Connectors	To be used with	Bandwidth	Matching	Length included	Addl. parts
15441A	SMA to SCI	10	SMA (m) - SCI (f)	675 Mb/s	tt ≥ 500 ps	No	1.5 m	4 SCI adapters
15442A	SMA	4	SMA (m) - SMA (m)	675 Mb/s/ 2.7/(3.35) Gb/s	tt ≥ 100 ps	No	1 m	-
15443	SMA matched pair	2	SMA (m) - SMA (m)	675 Mb/s/ 2.7/(3.35) Gb/s	tt ≥ 100 ps	Yes	1 m	-
N4869A	SMA & phase shifter	3	SMA (m) - SMA (m)	E4866A out to N4868A in	tt ≥ 50 ps	Adjustable	0.4 m	Mech. phase Shifter + -50 ps
N4870A	1.85 mm matched	2	1.85/2.4 mm 1.85/2.4 mm	N4868A out E4868A/B out E4869A/B in	tt ≥ 15 ps	± 1.5 ps	0.63 m	-
N4871A	SMA matched	2	SMA (m) - SMA (m)	3.35/10.8 Gb/s front-ends	tt ≥ 50 ps	± 1.5 ps	1 m	-
N4910A	2.4 mm matched pair shifter	2	2.4 mm - 2.4 mm	7 Gb/s, 13.5 Gb/s			0.60 m	-





## 40G bundles

E4894B	43.2 Gb/s pattern generator bundle
E4894B-UK6	Commercial cal. certificate w/test data
E4895B	43.2 Gb/s error detector bundle
E4895B-UK6	Commercial cal. certificate w/test data
E4896A	45 Gbit/s & 3.35 Gbit/s pattern generator bundle
E4896A-UK6	Commercial cal. certificate w/test data
E4897A	45 Gbit/s & 3.35 Gbit/s error detector bundle
E4897A-UK6	Commercial cal. certificate w/test data

## Accessories

15440A	Adapter kit: 4* SMA (M) I/O adapters
15441A	Cable kit: 10*SMA (m) to SCI connector
15442A	Cable kit: 4*SMA (m) to SMA (m)
15443A	Matched cable pair
15444A	Monitor
15445A	External CD-ROM
15446A	8-line trigger input pod
15447A	Deskew probe
E4839A	Test fixture
15448A	Pogo cable kit: 4*SMA(m) & 2 pogo adapter
15449A	DUT board 50 $\Omega$ impedance
N4869A	Cable Kit: 3 cables with phase adjuster for connecting E4866A with N4868A
N4870A	Cable kit: 2.4 mm for N4868A output
N4871A	Cable kit: SMA matched pair, 50 ps
N4910A	Cable kit: matched cable pair for 13.5 G
N4911A-002	Adapter 3.5 mm female to 2.4 mm male
N4912A	2.4 mm 50 $\Omega$ termination, male connector
N4913A	4 GHz deskew probe

## **Storage of Customer Specific Data in Agilent ParBERT 81250 Parallel Bit Error Ratio Tester Data Generator/Analyzer Modules and Front Ends**

This statement is to certify that none of Agilent Technologies' ParBERT 81250 clock modules, data generator / analyzer modules or front ends store customer specific data in any non-volatile memory. As a general rule it can be said that after electrical power has been turned off, the modules will not store any data or settings.

Data storage across power down / power up cycles will only appear in the ParBERT's PC Controller where access to the data can be controlled via generic Microsoft ® Windows ® security mechanisms.

**This page intentionally left blank**

## Related literature

- Need to Test BER? Brochure
- Agilent ParBERT 81250, Mux/Demux Application, Application Note
- Agilent ParBERT 81250 13.5 Gb/s Parallel Bit Error Ratio Test Platform, Photocard
- Agilent Productivity Assistance
- Agilent ParBERT 81250 43.2/45 G, Product Overview
- Agilent ParBERT 81250 Parallel Bit Error Ratio Test Platform, Data Sheet
- Agilent 81250 ParBERT Product Note (The influence of Generator Transition times on Characterization Measurements)

## Publication number

5968-9250E  
5968-9695E  
  
5988-9201EN  
  
5980-2160E  
5988-3020EN  
  
5988-5901EN  
  
5988-5948EN

## Agilent Technologies' Test and Measurement Support, Services, and Assistance

Agilent Technologies aims to maximize the value you receive, while minimizing your risk and problems. We strive to ensure that you get the test and measurement capabilities you paid for and obtain the support you need. Our extensive support resources and services can help you choose the right Agilent products for your applications and apply them successfully. Every instrument and system we sell has a global warranty. Support is available for at least five years beyond the production life of the product. Two concepts underlie Agilent's overall support policy: "Our Promise" and "Your Advantage."

### Our Promise

Our Promise means your Agilent test and measurement equipment will meet its advertised performance and functionality. When you are choosing new equipment, we will help you with product information, including realistic performance specifications and practical recommendations from experienced test engineers. When you use Agilent equipment, we can verify that it works properly, help with product operation, and provide basic measurement assistance for the use of specified capabilities, at no extra cost upon request. Many self-help tools are available.

### Your Advantage

Your Advantage means that Agilent offers a wide range of additional expert test and measurement services, which you can purchase according to your unique technical and business needs. Solve problems efficiently and gain a competitive edge by contracting with us for calibration, extra-cost upgrades, out-of-warranty repairs, and onsite education and training, as well as design, system integration, project management, and other professional engineering services. Experienced Agilent engineers and technicians worldwide can help you maximize your productivity, optimize the return on investment of your Agilent instruments and systems, and obtain dependable measurement accuracy for the life of those products.

### Agilent T&M Software and Connectivity

Agilent's Test and Measurement software and connectivity products, solutions and developer network allows you to take time out of connecting your instruments to your computer with tools based on PC standards, so you can focus on your tasks, not on your connections. Visit [www.agilent.com/find/connectivity](http://www.agilent.com/find/connectivity) for more information.

For more information on Agilent Technologies' products, applications or services, please contact your local Agilent office. The complete list is available at:

[www.agilent.com/find/contactus](http://www.agilent.com/find/contactus)

### Phone or Fax

#### United States:

(tel) 800 829 4444  
(fax) 800 829 4433

#### Canada:

(tel) 877 894 4414  
(fax) 905 282 6495

#### China:

(tel) 800 810 0189  
(fax) 800 820 2816

#### Japan:

(tel) (81) 426 56 7832  
(fax) (81) 426 56 7840

#### Korea:

(tel) (080) 769 0800  
(fax) (080)769 0900

#### Latin America:

(tel) (305) 269 7500

#### Taiwan:

(tel) 0800 047 866  
(fax) 0800 286 331

#### Other Asia Pacific

#### Countries:

(tel) (65) 6375 8100  
(fax) (65) 6755 0042

Email: [tm\\_ap@agilent.com](mailto:tm_ap@agilent.com)

For more information, please visit us at [www.agilent.com/find/parbert](http://www.agilent.com/find/parbert)

Product specifications and descriptions in this document subject to change without notice.

For the latest version of this document, please visit our website at [www.agilent.com/find/parbert](http://www.agilent.com/find/parbert) and go to the **Key Library Information** area or insert the publication number (5968-9188E) into the search engine.



## Agilent Email Updates

[www.agilent.com/find/emailupdates](http://www.agilent.com/find/emailupdates)

Get the latest information on the products and applications you select.

© Agilent Technologies, Inc. 2003, 2004

Printed in USA, July 26, 2004

5968-9188E



Agilent Technologies