

JULY 1981

INSTALLATION/OPERATION/DEMO NOTE

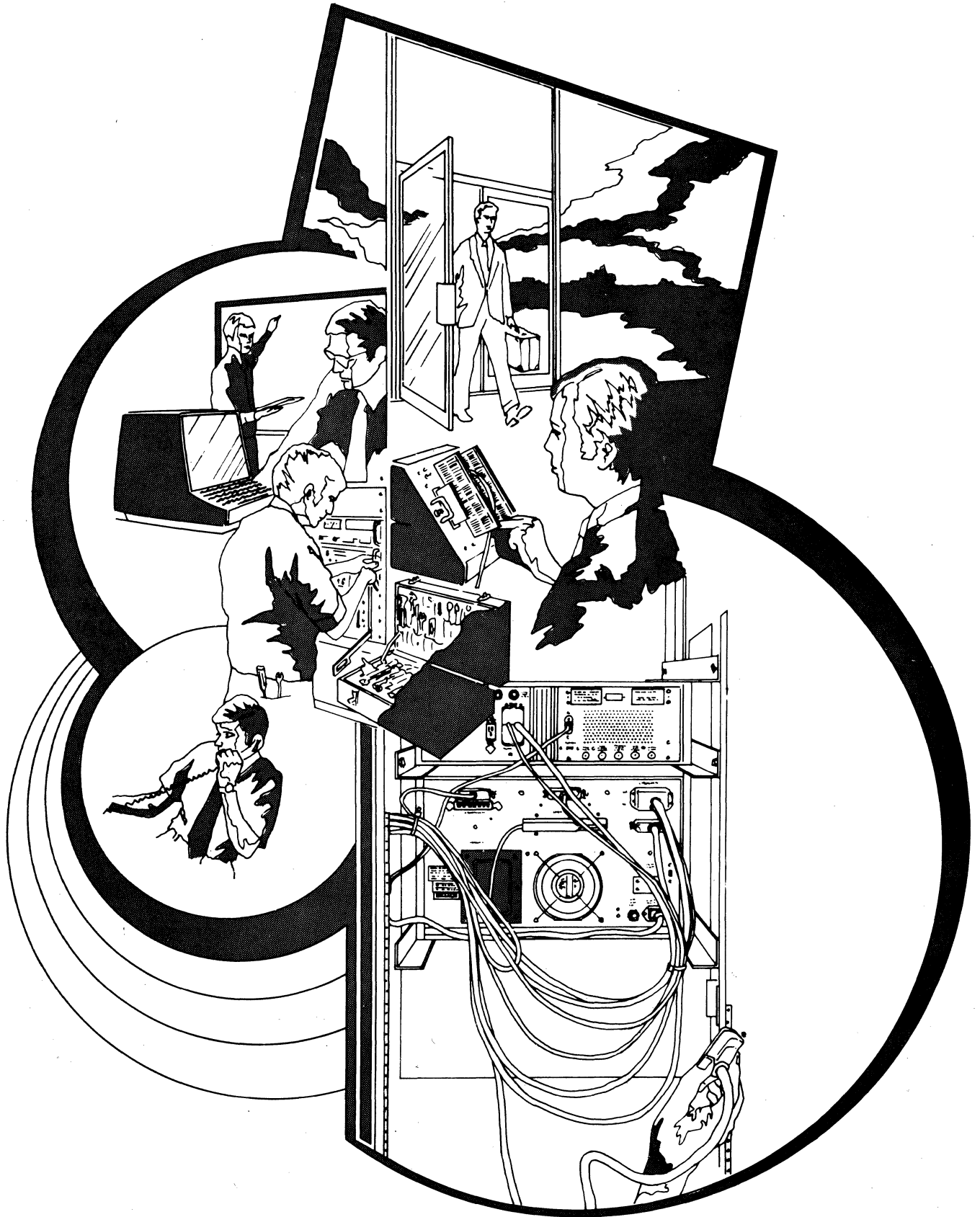

C O N T E N T S

5451C Fourier Analyzer Base System Installation	1
5440B Plug-In Mainframe Module (Options 600 & 601)	11
54420A Digital-to-Analog Converter (Option 620)	13
54440A Low Pass Filter (Option 640)	19
7210A Digital Plotter (Option 157)	25
HP-IB Digital Plotters	29
7970 Magnetic Tape (Option 261-265)	33
9866A Printer	35
54470A Fourier Pre-Processor (Option 670)	37

5451C INSTALLATION/OPERATION DEMO NOTE

INTRODUCTION

This note provides installation procedures and an operational demonstration of the standard 5451C Fourier Analyzer and common hardware options. Detailed operator training is NOT a function of the installer or of this note. The sole purpose of this note is to demonstrate that the hardware and software is operating properly. For detailed operating instructions see the 5451C Operating Manual supplied with the system.

INSTALLATION

The system, before shipment from the factory, was tested as a completely integrated system. This includes all Fourier operating system tests and Q.A. testing of the system and all peripherals. Running the following operational demonstration will verify system operation. Processor and peripheral diagnostics should only be run if the system fails one of the following tests.

MATERIAL LIST

The System Configuration Notice included with the system contains a complete list of all material shipped with the system. This material list should be checked to verify the shipment of all items ordered as well as verifying the serial numbers of all hardware. In the System Configuration Notice is the index as to binder location of all documentation.

CABLING

Standard 5451C systems are rack-mounted with all interface cards and cables installed. The System Configuration Notice contains the I/O configuration of the system.

If the system was ordered without a rack, it is the users responsibility to install the system and cabling as shown in the 5451C Service Manual, Section 1 (System Interconnection Diagram), and the System Configuration Notice.

NOTE

For all rack-mounted systems, the user must provide the mains power cable hook-up. Variations in local electrical safety codes prevent standardization of mains connections. At all times a proper ground must be connected to all system hardware. Refer to the Installation and Service Manual for the 29402B Cabinet for complete wiring information.

OPERATIONAL CHECK

EQUIPMENT REQUIRED

- o HP 3311B (or equivalent) Audio Oscillator;
Sinewave: 1 Hz to 100 kHz, +/-5V
- o Configured Fourier Analyzer System Disk Pack;
P.N. 54451-10001 or 54451-10101 for systems with the 7906A
disc drive or 54451-10102 for systems with a mag tape.

SETUP PROCEDURE

1. Turn power on to all equipment and ready the disc or
mag tape with the system pack.
2. Set up the Terminal to Alphanumeric. (Press STOP and SHIFT G DSP)
3. Set 54451A Processor S-Register to 101701.
4. Press Store.
5. Press Preset, IBL/Test, RUN.
(should get HALT 76)
6. Press Run.
(should get HALT 77)
7. Press Run.
8. The System should come up with a display on the CRT.

Set up front panel switches as follows:

5460A DISPLAY	All lever switches to middle position VERTICAL GAIN CAL VERTICAL MODE REAL MAGNITUDE VERTICAL SCALE to 12 o'clock position ARM/PLOT ARM
5466B ADC	TRIGGER SOURCE to INTERNAL (A) TRIGGER LEVEL to 12 o'clock Rotary switches A and B to 1 volt INPUT SELECTOR and DISPLAY ... to A positions SAMPLE MODE to kHz/us
5475A KEYBOARD	REPEAT/SINGLE to REPEAT STEP/RUN to RUN

Press the following keyboard keys to set a blocksize of 128 and to begin the analog input and display cycle:

PRESS: BLOCK SIZE, 1 2 8 ENTER

ANALOG IN, ENTER

NOTE

In the following procedures, the ADC SAMPLE MODE and MULTIPLIER positions are listed left to right as they appear on the front panel (e.g., TIME/HZ/ms and 5/10/100). Remember that color codes under the SAMPLE MODE switch correspond to the same color under the MULTIPLIER switch. Time is in BLACK lettering, maximum frequency is in BLUE, and frequency spacing is in white.

ADC Δ F SAMPLING DEMO

SET: 5466B SAMPLE MODE Δ FREQ/HZ ms
MULTIPLIER 50/100/10
TRIGGER SOURCE INTERNAL (A)
SLOPE +
Rotary switch A CHECK
TRIGGER LEVEL adjust for pulse on
left of display

SET: 5460A DISPLAY TYPE TO CONT

OBSERVE: pulse 1.7 cm high by 1.1 cm
wide, approximately.

SAMPLING DEMO

SET: 5466B MULTIPLIER 25/50/20
INPUT SELECTOR & DISPLAY A
Rotary switch A CHECK

OBSERVE: 2 pulses 1.7 cm high or one
full pulse for 50 Hz power mains.

ADC ΔT SAMPLING DEMO

SET: 5466B SAMPLE MODE ΔTIME/kHz us
MULTIPLIER 1K/1/.5

OBSERVE: string of pulses (one or two dots per pulse is normal).

SET: 5466B SAMPLE MODE ΔTIME/HZ ms
MULTIPLIER 10/20/50

OBSERVE: 1 pulse on left of display 1.7 cm high
(may be more pulses depending on trigger
level and mains frequency; will take
several seconds for a full sweep).

BLOCKSIZE/SAMPLING DEMO

SET: 5466B SAMPLE MODE ΔFREQ/HZ ms
MULTIPLIER 10/20/50

OBSERVE: position of pulses on display

PRESS: RESTART key (observe BUSY light goes
off, READY goes on)

BLOCK SIZE 2,5,6, ENTER (observe blocksize
light 256 goes on)

PRESS: ANALOG IN, ENTER (observe BUSY and
TRIGGERING lights
go on)

OBSERVE: position of pulses same as
above.

PRESS & REPEAT from RESTART for all blocksizes
up to 4096. (Note for some systems
blocksize 2048 is the maximum
available. Press RESTART when done.)

2-CHANNEL ADC INPUT COMPARISON DEMO

This check demonstrates that the inputs on the ADC are matched within +/- .4%.

KEYBOARD PROGRAM

Load the following keyboard program before this checkout is begun. Note the minus "-" Key below is in the DATA OPERATIONS Keys, not the ENTRY Keys.

```
RPLAC 0 ENTER
LABEL 10 ENTER
BLOCK SIZE 1024 ENTER
JUMP 1 ENTER
- 1 ENTER
POLAR ENTER
DSPLY 0 ENTER
JUMP 10 ENTER
LABEL 11 ENTER
JUMP 1 ENTER
LOAD 1 ENTER
- 2 ENTER
POLAR ENTER
DSPLY 0 ENTER
JUMP 11 ENTER
LABEL 12 ENTER
JUMP 1 ENTER
LOAD 2 ENTER
- 3 ENTER
POLAR ENTER
DSPLY 0 ENTER
JUMP 12 ENTER
LABEL 1 ENTER
ANALG IN ENTER
F 0 SPACE 1 ENTER
F 2 SPACE 3 ENTER
SUB RTRN ENTER
END ENTER
TERM ENTER
```

After entry, the resident keyboard program can be checked by pressing "LIST ENTER" and comparing the results with the following:

1	L	10	55	L	12		
5	BS	1024	59	J	1		
9	J	1	63	X<	2		
13	A-	1	67	A-	3		
17	TP		71	TP			
20	D	0	74	D	0		
24	J	10	78	J	12		
28	L	11	82	L	1		
32	J	1	86	RA			
36	X<	1	89	F	0		1
40	A-	2	94	F	2		3
44	TP		99	<			
47	D	0	102	.			
51	J	11					

```

SET:  5466B  SAMPLE MODE ..... INT, kHz us
        MULTIPLIER ..... 25/50/20
        INPUT SELECTOR ..... AB
        TRIGGER SOURCE ..... FREE RUN
        Rotary switches A and B ..... as specified in test
                                         table (e.g., .125)

        3311B  Frequency dial ..... 10 kHz
        Set output to ..... see test table below
        Output connected to ..... INPUT CHANNEL A and B
        FUNCTION ..... 

        5475A  REPEAT/SINGLE ..... SINGLE
    
```

TEST FOR ADC CHANNELS

The voltages below do not have to be exact and the system can be used to measure them by doing the following:

```

Set:    REPEAT/SINGLE switch to REPEAT
        5466B Rotary Switch A as in Test Table below
        Display switch to A
    
```

```

Press:  ANALG IN ENTER
    
```

Now set the oscillator output voltage as per Test Table. Note: each centimeter on the CRT is one-fourth of the OVERLOAD VOLTAGE (A) switch setting.

TEST TABLE FOR CHANNELS A,B,C,D

5466B Rotary Switches	3311B Output Voltage Sinewave	Maximum Voltage Permissible on 5460A Display
.125 volt	60 mV rms (170 mV P-P)	+/-2 X 10E -4 volt
1 volt	.5 V rms (1.4 V P-P)	+/-2 X 10E -3 volt
8 volts	3 V rms (8.5 V P-P)	+/-2 X 10E -2 volt

Once the oscillator output voltage has been set, return the REPEAT/SINGLE switch to SINGLE.

PRESS: JUMP 10 ENTER (compares channels A and B)

OBSERVE: maximum voltage shown in test table. Repeat JUMP 10 ENTER command for each voltage change in column 1.

The maximum output voltage on the 5460A Display will be the value shown in column 3 of the Test Table. (Disregard leftmost point. This point is the dc offset difference and does not affect dynamic measurements.)

Read the display by multiplying the number of cm deflection on CRT by scale factor on readout tubes, e.g., 2 X 10E -4 volts per cm.

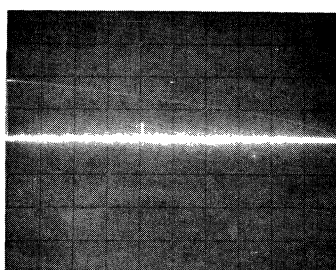

Typical result with Channel A to B comparison. 5460A Display Plug-In indicates 2 x 10-004 volts/cm.

4-CHANNEL ADC INPUT COMPARISON DEMO

Perform this check only if the system contains a 4-channel ADC option (refer to the system configuration NOTICE).

To Check Channels B and C, SET:

5466B INPUT SELECTOR ABCD
 Rotary switches B & C as specified in Test
 Table for A,B,C,D.

3311B AMPLITUDE as specified in
 Test Table.
 Connect output to INPUT CHANNELS B and C

PRESS: JUMP 11 ENTER compares channels B & C

OBSERVE: Maximum output voltage not to
 exceed any values shown in
 previous test table.

To Check Channels C and D SET:

5466 INPUT SELECTOR ABCD
 Rotary Switches C & D as specified in Test Table
 for A,B,C,D.

3311 AMPLITUDE as specified in Test Table
 Connect output to INPUT CHANNELS C & D

Press JUMP 12 ENTER compares channels C and D

Observe maximum output voltage not
 to exceed any values shown
 in previous test table.

FOURIER TRANSFORM DEMO

SET: 5460A MODE REAL MAGNITUDE
 SCALE 12 o'clock
 DISPLAY TYPE CONT

PRESS: BLOCK SIZE 1024 ENTER
 CLEAR 1 ENTER
 CLEAR ENTER
 KEYBOARD 1 SPACE 1 SPACE 1 ENTER (These keyboard operations
 manually enter 2V cosine
 KEYBOARD 0 SPACE 4 ENTER and -2V sine values into
 2 SPACE -2 ENTER frequency domain data
 block)

NOTE: Use "-" in the ENTRY(numeric) key group, not the DATA
 OPERATIONS(arithmetic) "-".

OBSERVE: A single spike on the left of the CRT, as shown in the photo below. Read the 5460A indicators to determine the volts per centimeter (i.e., 5460 indicates $1 \times 10^{\boxed{0}\boxed{0}\boxed{0}} = 1 \text{ volt per cm}$).

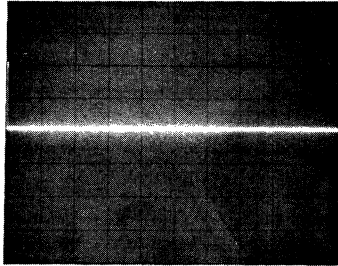

The spike in this example is 2 cm high times 1 volt per cm equals 2 volts peak.

Set 5460A MODE switch to IMAGINARY PHASE.

OBSERVE: A single negative spike on left of the CRT (see below).

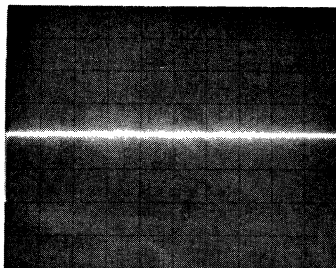

PRESS: LOAD 1 ENTER
F ENTER

NOTE

The above frequency domain spectrum of $2\omega \cos t - i 2 \sin t$ is fourier transformed into the phase shifted sine wave below. Peak to peak amplitude is:

$$V_{p-p} = 4\sqrt{(2)^2 + (2)^2} = 11.3V$$

The Fourier transform algorithm takes advantage of the properties of spectral symmetry centered at DC of real time functions and calculates and displays only the positive frequencies in a spectrum. To account for displaying only 1/2 the total spectral energy the the amplitude values displayed are 1/2 the amplitude of the corresponding time domain periodic components. For example a single 2 volt peak point in the real frequency domain display represents the Fourier transform of a 4 volt peak cosine function.

OBSERVE: A sine waveform with an amplitude of 11.3 volts peak-to-peak, and a phase of 45 degrees. See waveform. Use the 5460A SCALE switch to expand the vertical display.

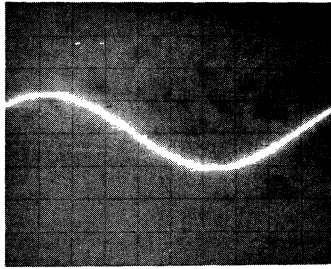

Perform this test to check that the disc is working correctly. Data will be stored in record 0 of File 1 on the disc. This check should be done immediately after the Fourier Transform Demo because use is made of the sine wave generated at that time.

PRESS: MASS STORE 31 ENTERto position disc to File 1 and Record 0

PRESS: MASS STORE 21 ENTERto write data block 0 to disc

PRESS: CLEAR ENTERto clear data block 0 in memory

PRESS: MASS STORE 31 ENTERto position disc to read back data

PRESS: MASS STORE 11 ENTERto read previous data stored on disc

OBSERVE The sine wave previously on the CRT should now be displayed.

By performing the above steps we have shown that information can be written and retrieved from the disc.

This ends the operational demonstration of the base 5451C system. If, for any reason, one of the procedures did not work, check the appropriate Service Manual for further information.

MODEL 5440B PLUG-IN MAINFRAME MODULE (PIMM)

(Option 600 and 601)

INTRODUCTION

This section provides installation and/or connection procedures for the 5440B Main Frame. Because the 5440B can not be operated as a standalone unit, see the appropriate section of this note for the installation/operational demonstration of the plug-in(s) to be used with the 5440B.

INSTALLATION

If the PIMM was a factory-integrated option, then skip this section and go directly to the section(s) on the plug-in(s) to be used with the PIMM.

Install the PIMM (Option 600 or 601) in a convenient rack location. Install the 05451-60025 I/O card into the Processor's select code 13 unless otherwise specified in the System Configuration Notice. Refer to the Table below for the proper strapping. Connect the Mainframe Input/Output Bus (MIOB) cable and/or MIOB Link cable to J1 as in the 5440B cabling diagram below.

DESCRIPTION

None of the signals carried in the MIOB Cable are used by the 5440B itself. The signals carried by this cable are solely for the purpose of communicating between a Module plugged into a 5440B and the processor in which the 05451-60025 is operating.

In module-processor communication, the 5440B is "transparent", serving, in effect, as merely an additional length of cable. The signals are routed through the 5440B's A1 card, which contains some circuitry to enhance the waveshape of the Command and Flag signals carried between a module and the processor.

The ribbon connector end of the MIOB cable is connected to J1 of the 5440B. (In the case of concatenated 5440B's, the ribbon connector end of the cable is connected to the available mating connector of any MIOB LINE cable connected to the J1 connector of any of the 5440B's, as illustrated in the interface block diagram below. In this case, the signals at the 5440B end of the cable are connected, in parallel, to all of the 5440B's.)

05451-60025 Strapping

W1 to C	W9 to A
W2 to B	W10 to Pin D of W1
W3 to B	W11 to A
W4 to B	W12 installed
W5 thru W8 installed	W13 removed

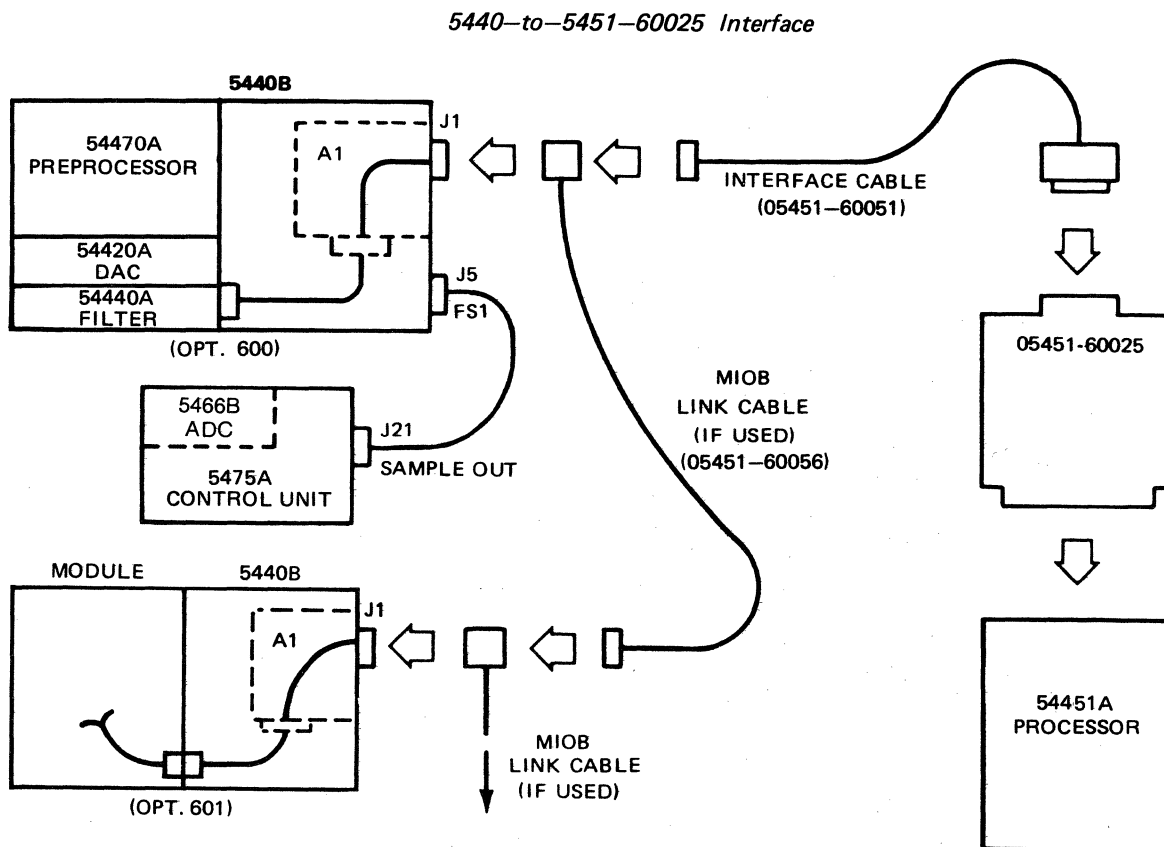

NOTE

Because of the combination of modules which can be used in the 5440B, see the appropriate section for internal jumper connections.

MODEL HP 54420A DIGITAL-TO-ANALOG CONVERTER (DAC)

(Option 620)

INTRODUCTION

This section provides installation procedures and an operational demonstration for the installer of Option 620, Model 54420A DAC. The operation demonstration portion of this note demonstrates that the DAC is functioning properly. To verify the specifications, refer to the DAC Module Manual. If the Plug-In Mainframe Module is also an add-on option with the DAC, see Option 600/601 installation in this note before proceeding.

INSTALLATION

Before installing the DAC into Plug-In Mainframe Module, verify that the switches on the internal DAC cards are in the proper position (see DAC Switch Setting Table below).

Connect a BNC cable from J21 Sample Out on the rear of the 5475A Control Unit to the J5 (Fsl) connector on the rear of the 5440B containing the DAC.

NOTE

If there is more than one 5440B Mainframe in the system, then the DAC should be plugged into the 1st Mainframe, NOT into the concatenated 5440B.

DAC SWITCH SETTING TABLE

The switches between card A5 and A6 on the DAC motherboard should be set as follows:

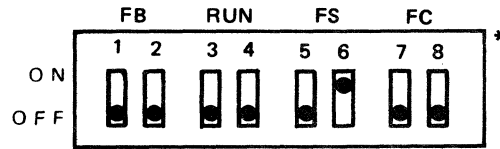

The Address switches on the A7 and A8 cards are set for address 15 octal. All switches up toward top of board equal 15 octal.

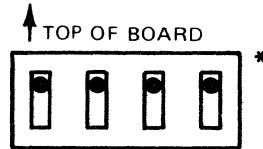

*NOTE: Dot represents rocker switch down.

Remove the 5440B top cover and check the position of the MIOB connector between the A1 and A2 board of the 5440B. If there is NOT a 54470A pre-processor in the PIMM then the jumper should be in position A so the DAC can be plugged into any slot. See the MIOB Jumper Table below if a 54470A is in the System before plugging in the DAC.

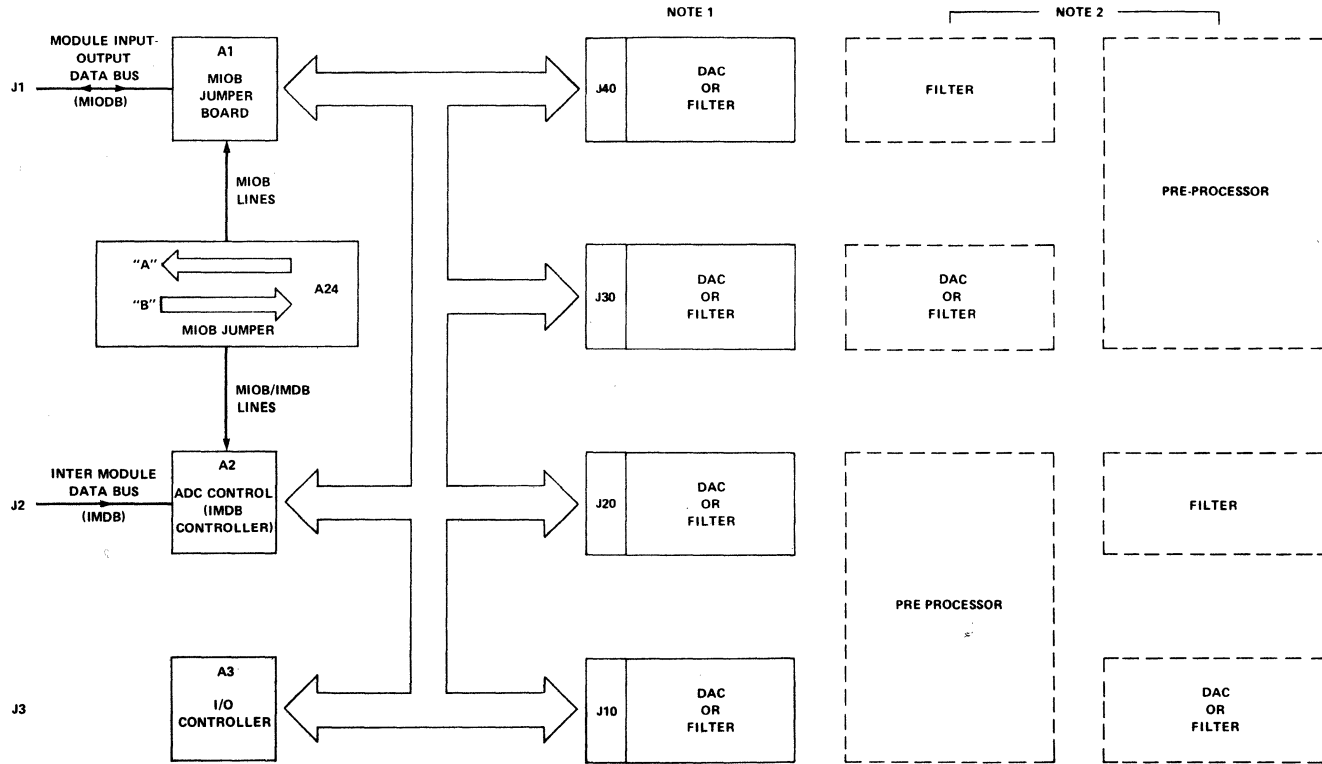

NOTE 1

NOTE 2

NOTE:

- 1- MIOB JUMPER IN "A" POSITION
 - a- DAC OR FILTER CAN BE IN ANY SLOT.
- 2- MIOB JUMPER IN "B" POSITION
 - a- DAC TO BE IN SLOTS J10 OR J30 ONLY.
 - b- FILTER CAN BE IN ANY SLOT.
 - c- PRE-PROCESSOR CAN BE IN EITHER HALF OF MAINFRAME BY REMOVING DIVIDERS BETWEEN J10 & J20 OR J30 & J40.

MIOB JUMPER TABLE

OPERATIONAL DEMONSTRATION

To operate the DAC, load in the system (if not already running) as follows:

1. Set Processor's S-Reg = 101701 or if using 7906 Disc Drive = 111700
2. Press PRESET, IBL/TEST, and RUN
3. Press RUN to load in System
4. Press RUN to start up System

Load the following keyboard program before the checkout is begun.

```

RPLAC  0  ENTER
LABEL  0  ENTER
CLEAR  1  ENTER
LABEL  1  ENTER
ANALG IN  0  SPACE  1  ENTER
F  ENTER
POWER SPECT  ENTER
COUNT  1  SPACE  16  ENTER
LOAD  1  ENTER
LOG MAG  ENTER
DSPLAY  ENTER
LABEL  20  ENTER
PRINT  0  SPACE  26  ENTER
PRINT  0  SPACE  127  ENTER
PRINT  0  SPACE  225  ENTER
DSPLAY  ENTER
END  ENTER
TERM  ENTER

```

After entry, the resident keyboard program can be checked by pressing "LIST ENTER" and comparing the results with the following:

```

1  L      0
5  CL     1
9  L      1
13 RA    0      1
18 F
21 SP
24 #      1      16      0
30 X<    1
34 TL
37 D
40 L      20
44 W      0      26
49 W      0      127
54 W      0      225
59 D
62 .

```

OUTPUT FREQUENCY RESPONSE TEST

This test verifies that the frequency response for each filter range meets the overall DAC specifications for flatness. Note that the test spectrum for the DAC amplifier/filter flatness response has been compensated for the inherent $(\sin X)/X$ rolloff due to the sample and hold nature of DAC-generated signals. This test also checks that the filter is attenuating the stopband properly by checking one point on the transition slope. A 3-tone signal is created to check the output filter at 2 frequencies in the passband and one in the transition band rolloff (see keyboard program below).

SETUP (Use "-" in the ENTRY(numeric) key group, not the DATA OPERATIONS(arithmetic) group).

Press keys :

```

RESTART
BLOCK SIZE 512 ENTER
CLEAR ENTER
KEYBOARD 0 SPACE 26 SPACE 26 ENTER
KEYBOARD -4 SPACE 4 ENTER
5022 SPACE 0 ENTER
KEYBOARD 0 SPACE 127 SPACE 127 ENTER
KEYBOARD -4 SPACE 4 ENTER
5545 SPACE 0 ENTER
KEYBOARD 0 SPACE 225 SPACE 225 ENTER
KEYBOARD -4 SPACE 4 ENTER
7030 SPACE 0 ENTER
F ENTER
STORE 2 ENTER

```

Set controls:

```

5466B SAMPLE MODE to kHz/uSEC
MULTIPLIER to 25/50/20
INPUT SELECTOR & DISPLAY to A
OVERLOAD VOLTAGE A to 8
TRIGGER SOURCE to FREE RUN
INPUT CHANNEL A to DC

5460A DISPLAY TYPE to CONT,FUNCTION to DISPLAY
All other controls to up or center position

5475A STEP/RUN to RUN
REPEAT/SINGLE to SINGLE
Connect the DAC output to the ADC INPUT CHANNEL A.

```

MEASUREMENT

Press keys :

RESTART
 ANALG OUT 2 ENTER
 JUMP 0 ENTER

Note : A power spectrum of output is measured .

JUMP 20 ENTER

The terminal will print:

J	20		
SF	0	14	39
(26)	-615	0
SF	0	14	39
(127)	-614	0
SF	0	14	39
(225)	-3757	0

ANALOG OUT ENTER

TEST RESULT

On the printout as shown above, channel 26 and 127 are within 0.2 dB (20 counts) of each other. (To find the difference, subtract the numbers circled above which should be within 20 counts.) Nominal value is -600. The printout of channel 225 should be at least -32 dB (-3200) down.

This ends the Option 620 Operation/Demonstration.

MODEL HP 54440A LOW-PASS FILTER

(Option 640)

INTRODUCTION

This section provides installation procedures and an operational demonstration for the installer of Option 640, Model 54440A Filter. The operation demonstration portion of this note demonstrates that the filter is functioning properly; for verification of Filter specifications, refer to the HP 54440A Module Manual. If the Plug-In Mainframe Module is an add-on option with the Filter, see Option 600/601 installation in this note before proceeding.

INSTALLATION

Check that the switch settings on the A8 Encoder card (in back right-hand corner) are set for the desired address of the Filter. Normal numbering sequence begins with 1 for the first Filter and proceeds upward to 15. (Address 15 is reserved for the DAC, Option 620, if installed.) See Figure below for setting the Address switches.

The Filter Address is the number used to address a specific filter when entering commands from the Keyboard. Place the appropriate address sticker on the Filter front panel to match the address you set the A8 card switch.

Address Switch Setting

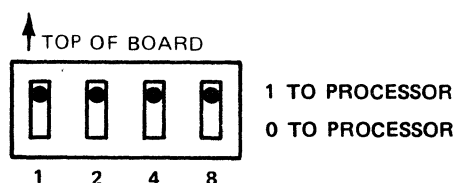

Example: Switch above with switches 1 and 4 set to 1 will have Filter address of 5.

OPERATIONAL DEMONSTRATION

To operate the Filter, load in the System (if not already running) as follows:

1. Set processor S-Reg = 101701
2. Press PRESET, IBL/TEST, and RUN
3. Press RUN to load in system
4. Press RUN to start up system
5. The system should come up running the display

The test procedure is dependent upon the following keyboard program. Press keys:

```

REPLACE ENTER
LABEL 20 ENTER
BLOCK SIZE 512 ENTER
CLEAR 2 ENTER
CLEAR 3 ENTER
CLEAR 4 ENTER
CLEAR 5 ENTER
LABEL 21 ENTER
ANALG IN 0 SPACE 2 ENTER
HANN ENTER
HANN 1 ENTER
← 0 SPACE 256 ENTER
← 1 SPACE 256 ENTER
F 0 SPACE 1 ENTER
∫ 0 SPACE 2 SPACE 254 ENTER
∫ 1 SPACE 2 SPACE 254 ENTER
INTER CHGN 1 ENTER
CLEAR 0 SPACE 0 SPACE 250 ENTER
POWER SPECT 0 SPACE 2 SPACE 2 ENTER
COUNT 21 SPACE 8 ENTER
TRANS FCN 0 SPACE 2 SPACE 2 ENTER
LOG MAG ENTER
PRINT 0 SPACE 252 ENTER
DSPLY 0 ENTER
JUMP 20 ENTER
END ENTER
TERM ENTER

```

To check the resident keyboard program, press "LIST ENTER" and compare the result with those shown below.

1	L	20		
5	BS	512		
9	CL	2		
13	CL	3		
17	CL	4		
21	CL	5		
25	L	21		
29	RA	0	2	
34	H1			
37	H1	1		
41	-	0	256	
46	-	1	256	
51	F	0	1	
56	\$	0	2	254
62	\$	1	2	254
68	X	1		
71	CL	0	0	250
77	SP	0	2	2
83	#	21	8	0
89	CH	0	2	2
95	TL			
98	W	0	252	
103	D	0		
107	J	20		
111	.			

These tests check the in-band gain and flatness of the Filter. The throughput gain of the output amplifier is checked for a gain accuracy of ± 0.04 dB before each filter channel is checked for specified 0.2 dB flatness and gain.

NOTE

The ADC is assumed to be in calibration and is used as the standard by which the Filter is tested. Verify the ADC accuracy by inputting the same signal into both ADC inputs, pressing JUMP 20 ENTER.

SETUP

Set controls and connect test equipment as follows:

5466B Sample Mode to kHz us
 MULTIPLIER to 100/10/5
 INPUT SELECTOR to AB
 OVERLOAD VOLTAGE A & B to 2 (DC)

Connect the output of an oscillator to the Filter input and to channel B of the ADC. Connect the Filter output to channel A of the ADC. Set the oscillator frequency to 1 kHz +/-50 Hz and the amplitude to 1V P-P.

TEST

Press keys:

USER PROG 100 SPACE 99 SPACE n* ENTER
 JUMP 20 ENTER

*n = filter select code

RESULT

The printout on the System Terminal will indicate a gain of 0 +/- 0.05 dB. See sample printout below.

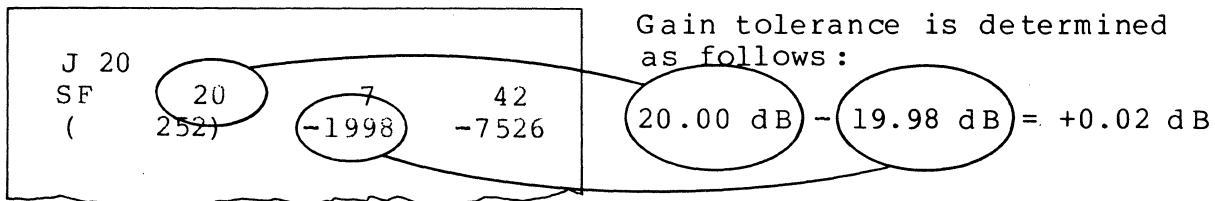

The following test checks the gain and flatness of each filter range at two frequencies: 0.1 times the cutoff and at the filter cutoff frequency, Fc. There are three filter boards with two to four filter ranges each.

The switch settings and frequency ranges are specified in the test table below.

SETUP

Connect the oscillator as specified for the previous test and set frequency to the first value shown in the Test Table.

TEST

Press keys:

```

USER PROG 100 SPACE 0 SPACE n ENTER
JUMP 20 ENTER

```

RESULT

With the filter range and the oscillator set to the first frequency specified in the test table, the printout will be 0 +/-0.1 dB, i.e., +/-10 counts.

TEST REPEAT

Perform the sequence above for frequencies denoted in the test table. This can be done by changing the oscillator frequency and the ADC multiplier switch followed by pressing the CONTINUE key on the Keyboards.

Test Table

Test Number	Oscillator Frequency	ADC Multiplier	Filter Range	Freq Code	GAIN pot Adjust
1	5 Hz	5K/.2/.1	50 Hz	33	A4
2*	50 Hz	5K/.2/.1	50 Hz	33	**
3	125 Hz	200/5/2.5	1.25 kHz	38	A2
4*	1.25 kHz	200/5/2.5	1.25 kHz	38	**
5	2.5 kHz	50/100/10	25 kHz	43	A3
6*	25 kHz	50/100/10	25 kHz	43	**

*For even numbered tests the oscillator must be set no higher than the filter cutoff. Use a counter or other means to verify exact frequency or set oscillator lower than F_c to assure errors in oscillator calibration do not cause a test at a frequency higher than F_c .

**If a test is close to meeting a spec (e.g., .11 dB instead of .1 dB spec) repeat the test two additional times to see if the condition is persistent.

MODEL HP 7210A DIGITAL PLOTTER

(Option 157)

INTRODUCTION

This section provides installation procedures and an operational demonstration of Option 157, Model HP 7210A Digital Plotter. The operation demonstration part of this section will check that the interfacing and Plotter are working correctly. Should a problem occur see the Service Manual for the Plotter and the System Service Manual for loading the Plotter diagnostic.

INSTALLATION

1. As Add-On to the System

Check that the jumpers on the interface card are as in the 7210A Jumper Table shown below. Install the interface card in the Processor as listed in the configuration notice and continue on to the following paragraph.

2. If Purchased With System

Connect the interface cable (17210-60020) between the I/O card and the HP 7210A Plotter. Connect the power cord and turn on the HP 7210A. Insert paper in the Plotter as per the HP 7210A Operator's Manual.

HP 7210A I/O CARD JUMPER TABLE

W1 to A	W5 through W8 Installed
W2 to A	W9 to B
W3 to B	W10 to A
W4 to B	W11 to A
	W12 through W13 Removed

OPERATIONAL DEMONSTRATION

The following Keyboard commands demonstrate the capabilities of the graphics software and the operation of the HP 7210A Plotter and interfacing. These same commands can be used to check the graphic Terminal in graphics mode.

This demonstration will plot a signal which will be put into the Processor as follows:

1. Enter commands:	Description:
BLOCK SIZE 512 ENTER	Set block size to 512 points.
CLEAR ENTER	Clear data block 0.
KEYBOARD 0 SPACE 6 SPACE 7 ENTER	Begin keyboard data sequence. Data entered in block 0 at points 6 & 7.
KEYBOARD 0 SPACE 0 SPACE 11 ENTER	Data is time domain with a scale factor of 0 (power of ten) and a maximum frequency of 50 Hz (code 11).
1 ENTER	Data value of 1
F ENTER	Fourier transform data to the frequency domain.

2. On the 5460A Display, set the switches as follows:

Mode to REAL/MAGNITUDE
 SCALE to 12 o'clock
 All other switches to CENTER

NOTE

Before you continue be sure you have inserted paper and set up the vertical and horizontal scale on the Plotter.

3. Enter commands:	Description:
USER PROG 5821 SPACE n* ENTER	Configure plot device.
* Note: n = 10 if plotter is HP 7210A n = 6 if checking graphics Terminal	
USER PROG PLOT ENTER	Automatically plot the displayed data.

The last command will copy the display and annotate the plot. The plot will be similar to Figure 1.

4. Set the 5460A Display Mode switch to COMPLEX. Insert new paper and ready the Plotter.

5. Enter commands:

Description:

USER PROG PLOT ENTER

Automatically plot the displayed data.

The complex display should now be drawn as in Figure 2 below.

FIGURE 1.

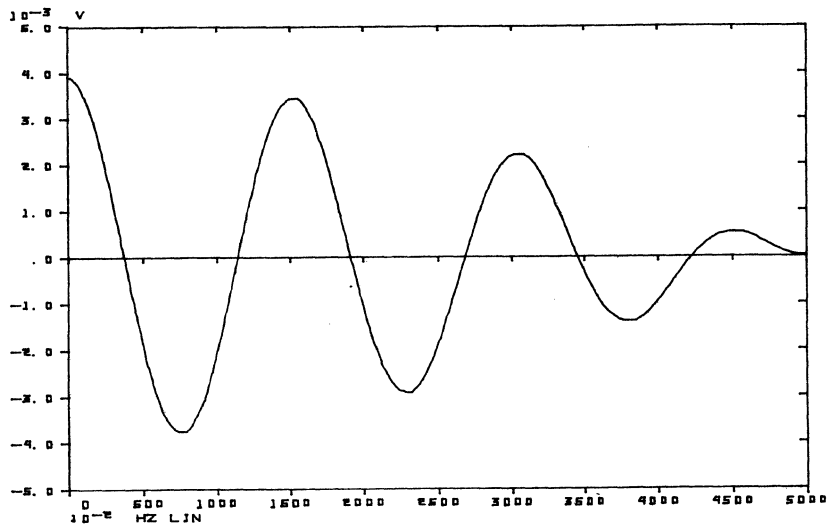
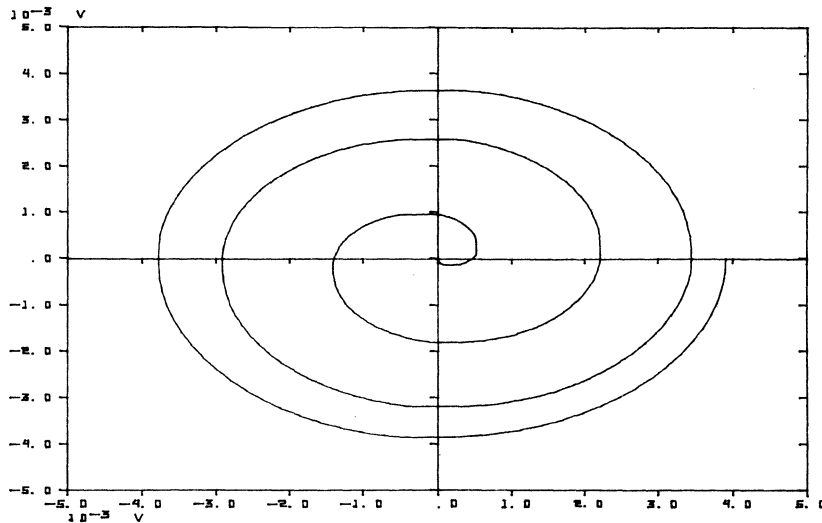

FIGURE 2.

NOTE: This plot does not appear as symmetrical as the CRT display since plotter calibration in complex mode is 8×10 rather than 10×10 cm as the CRT.



This completes the operational demonstration of the HP 7210A Plotter.

HP-IB DIGITAL PLOTTERS

INTRODUCTION

This section provides installation procedures and an operation demonstration of Digital Plotters operated through the 59310B HP-IB Interface. The operation demonstration part of this section will check that the interfacing and Plotter are working correctly. Should a problem occur see the appropriate Service Manual for the Plotter and the System Service Manual for loading the Interface diagnostic.

INSTALLATION

1. As Add-On to the System

Check that the jumpers on the interface card are as in the 59310B Switch Figure shown below. Install the interface card in the Processor in the appropriate I/O slot (normally select code 22 octal) and continue on to the following paragraph.

2. If Purchased With System

Connect the appropriate interface cable between the I/O card and the HP Plotter. Connect the power cord and turn on the Plotter. Insert paper in the Plotter as per the appropriate Operator's Manual. Set the plotting device HP-IB address to 5 octal.

Strapping of SW1, SW2 and W1 on HP-IB Interface PCA

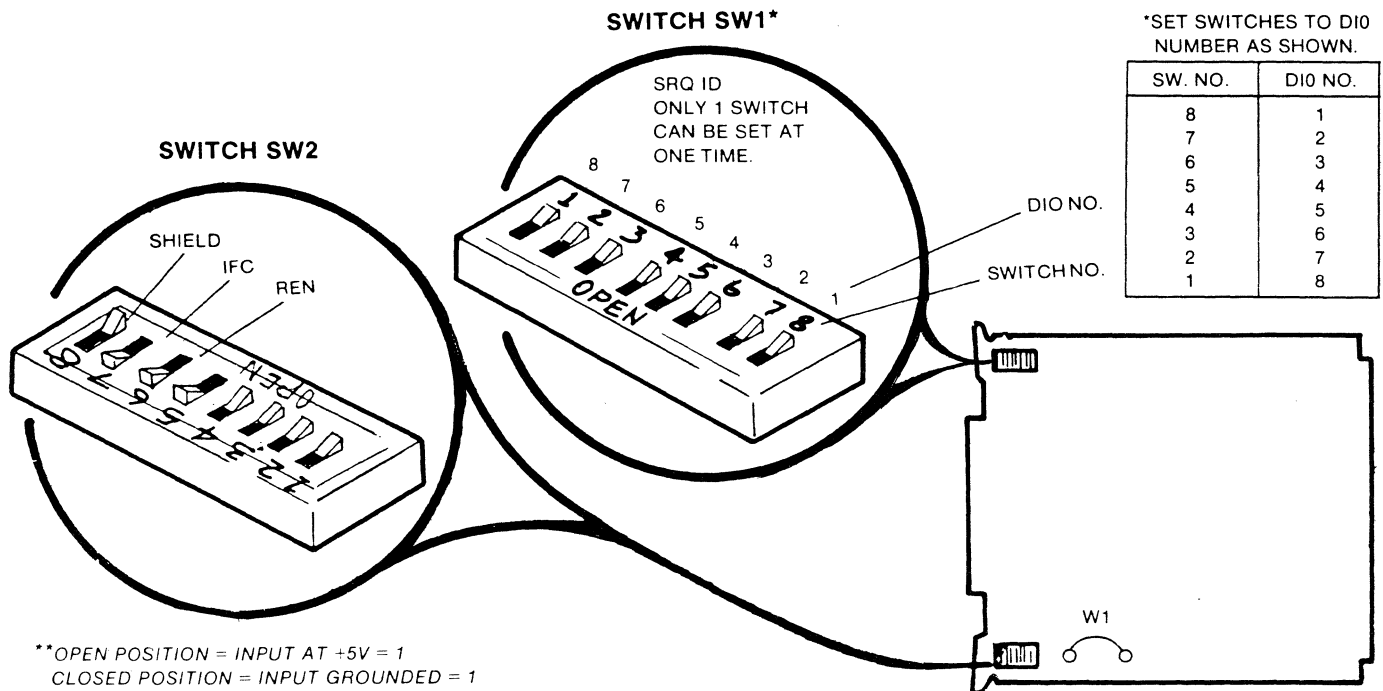

OPERATIONAL DEMONSTRATION

The following Keyboard commands demonstrate the capabilities of the graphics software and the operation of the HP Digital Plotter and interfacing.

This demonstration will plot a signal which will be put into the Processor as follows:

1. Enter commands:	Description:
BLOCK SIZE 512 ENTER	Set block size to 512 points.
CLEAR ENTER	Clear data block 0.
KEYBOARD 0 SPACE 6 SPACE 7 ENTER	Begin keyboard data sequence. Data entered in block 0 at points 6 & 7.
KEYBOARD 0 SPACE 0 SPACE 11 ENTER	Data is time domain with a scale factor of 0 (power of ten) and a maximum frequency of 50 Hz (code 11).
1 ENTER	Data value of 1
F ENTER	Fourier transform data to the frequency domain.

2. On the 5460A Display, set the switches as follows:

Mode to REAL/MAGNITUDE
SCALE to 12 o'clock
All other switches to CENTER

3. Enter Commands:	Description:
USER PROG "PLOT" 35 ENTER	Automatically plot the displayed data.

This command will copy the display and annotate the plot. The plot will be similar to Figure 1. If a multicolor plotter is used, data will be plotted using pen #1 and axes and labels will be plotted using pen #2.

4. Set the 5460A Display Mode switch to COMPLEX. Insert new paper and ready the Plotter.

5. Enter commands:	Description:
USER PROG 5881 SPACE 3 SPACE 4	Set up alternate pen colors.
USER PROG PLOT ENTER	Automatically plot the displayed data.

The complex display should now be drawn as in Figure 2 below. If a multicolor plotter is used, data will be plotted using pen #3, and axes and labels will be plotted using pen #4.

FIGURE 1.

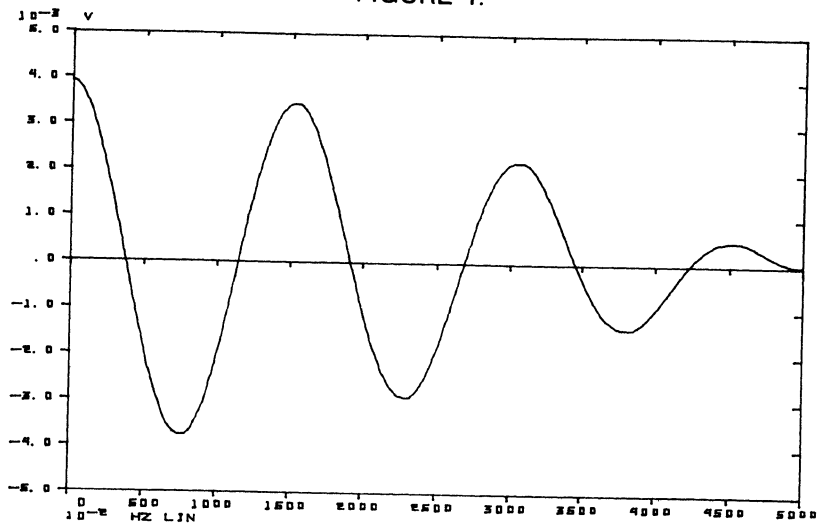
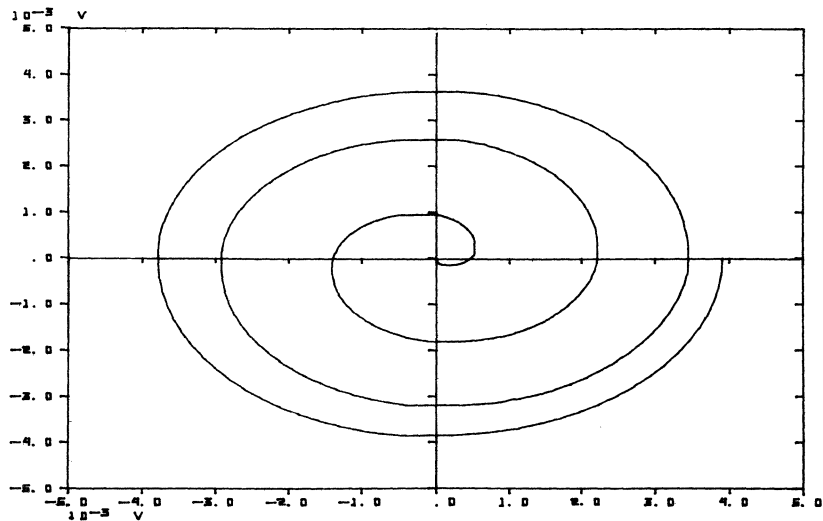

FIGURE 2.

NOTE: This plot does not appear as symmetrical as the CRT display since plotter calibration in complex mode is 8 x 10 rather than 10 x 10 cm as the CRT.



This completes the operational demonstration of the HP-IB Plotter.

MODEL HP 7970 MAGNETIC TAPE

(Options 261-265)

INTRODUCTION

This section provides installation procedures and an operational demonstration for the installer of Option 261 or Option 265. The operational demonstration part of this section will check that the Mag Tape is working correctly.

NOTE

As an add-on it will be the customers responsibility to generate an operating system software disc to operate the Mag Tape. If the customer has not already done so at the time of installation, the portion of this note after electrical connection cannot be run.

INSTALLATION

Rack the magnetic tape in available space in the cabinet. Plug the I/O cards in the following select codes:

1. For software rev. codes 1836A and later, use select codes 23 and 24.
2. For software rev. codes prior to 1836A, use select codes 24 and 25.
3. Or use the select codes to which the customer has configured his software.

The disc should be set up as sub-unit 0 on the front. Connect the interface cable between the magnetic tape and the interface cards. Install power cable and power up unit.

Set up the ADC as follows:

- Sample Mode to kHz/us
- Multiplier to 10/20/50
- Input Selector to A
- Overload A to CHECK
- Trigger to Free Run

Press the following keys on the Keyboard in the following sequence:

	Action or Results:
BLOCK SIZE 2048 ENTER	2048 light should light.
MASS STORE 32 ENTER	Position Mag Tape to Throughput record 0.
MASS STORE 22 SPACE 1 SPACE 10 ENTER	Write 10 records to Mag Tape.
MASS STORE 32 ENTER	Position Mag Tape to Throughput record 0.
CLEAR ENTER	Clear out block 0 in the Processor.
MASS STORE 12 ENTER	Read record 0 back from the Mag Tape and display it.

OBSERVE: The check pulse originally stored on the Mag Tape will now be on CRT. To check the other records stored on the tape repeat 9 times the CLEAR ENTER and MASS STORE 12 ENTER commands. The Mag Tape should move each time a record is read in the Processor.

This concludes the operation demonstration for the Mag Tape.

MODEL HP 9866A TERMINAL LINE PRINTER

(Option 110)

INTRODUCTION

This section provides installation procedures and an operational demonstration for the installer of the HP 9866A.

INSTALLATION

The thermal printer interfaces to the 5451C system through I/O card 05451-60025 and interconnecting cable 05451-60031. The system software is configured for installation in the I/O channel specified in the System Configuration Notice.

To install the thermal printer, insert all I/O cards into the slots specified in the System Configuration Notice. For operation with the thermal printer, verify that I/O card 05451-60025 jumper strapping is as follows:

W1 to A	W9 to A
W2 to B	W10 to A
W3 to A	W11 to A
W4 to B	W12 removed
W5 thru W8 removed	W13 removed

Connect the 05451-60025 I/O card using the 05451-60031 cable supplied. Install a roll of paper in the thermal printer and turn on power. Press the PAPER switch to advance paper. The hardware is now ready to operate.

OPERATIONAL DEMONSTRATION

After proper installation, proper operation of the thermal printer can be verified using the following procedure.

1. Set the 5451C system controls as follows:

5466B SAMPLE MODE to kHz/us
EXT/INT to INT
MULTIPLIER to 25/50/20
INPUT SELECTOR to A
OVERLOAD VOLTAGE A to CHECK
TRIGGERING to INTERNAL (A)
SLOPE to POS

5475A REPEAT/SINGLE to REPEAT

2. On the system keyboard press:

BLOCK SIZE 128 ENTER

The 128 BLOCK SIZE lamp on the keyboard should light.

3. On the keyboard press:

ANALG IN ENTER

Adjust TRIGGERING on the ADC for a single pulse display on the 5460A.

4. On the keyboard set REPEAT/SINGLE switch to SINGLE and press:

PRINT ENTER

5. On the Computer set "S" register bit 6 to on (lighted) and on the keyboard press:

PRINT ENTER

6. Compare the listing on the system terminal with the thermal printer listing. They should be the same.

This completes the operational demonstration for the 9866A. If a problem exists check the 9866A Service Manual.

MODEL HP 54470A FOURIER PRE-PROCESSOR

(Option 670)

INTRODUCTION

This section provides installation procedures and an operational demonstration for the installer of Option 670, Model 54470A PRE-PROCESSOR. If the Plug-In Mainframe Module is also an add-on option with the 54470A, then see the Option 600/601 installation in this note before proceeding.

INSTALLATION

1. Verify the I/O card strappings as in the table below:

I/O CARD STRAPPING

o I/O Card Strapping -- MIOB

W1 = C	W4 = B	W10 = Pin D of W1
W2 = B	W5 thru W8 = in	W11 = A
W3 = B	W9 = A	W12 = installed
		W13 = out

o I/O Card Strapping IMDB (ADC I/O P/N 05451-60025)

W1 = C	W4 = B	W10 = A
W2 = B	W5 thru W8 = out	W11 = A
W3 = B	W9 = A	W12 = out
		W14 = out

NOTE

If ADC I/O card P/N 05451-60068, set W1 = 5451C.

2. Verify the switch setting on the A5, A6, and A7 cards in the table on the following page.
3. Connect the MIOB cable (05451-60051) from the I/O card to J1 on the rear of the mainframe.
4. Connect the IMDB link cable (54470-60013) from the I/O card (ADC) to J2 on the rear of the mainframe and to J12 (ADC INTERFACE) on the rear panel of the 5475A (see Cable Diagram on next page).
5. Install the 54470A in the left (or right) half of the 5440B mainframe. (NOTE: The 54470A will not operate in the older 5440A Mainframe.) Remove the quarter-width module divider panel.
6. Install the MIOB JUMPER in the mainframe to the "B" position (B arrow forward).

Switch Settings

The 54470 FPP address switches on the A5, A6, and A7 cards are normally set for addresses as shown below.

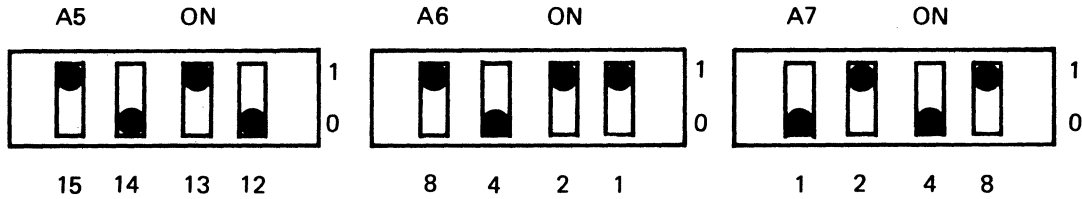

NOTE: If switches are not set to the proper address, the computer will halt.

Cabling Diagram

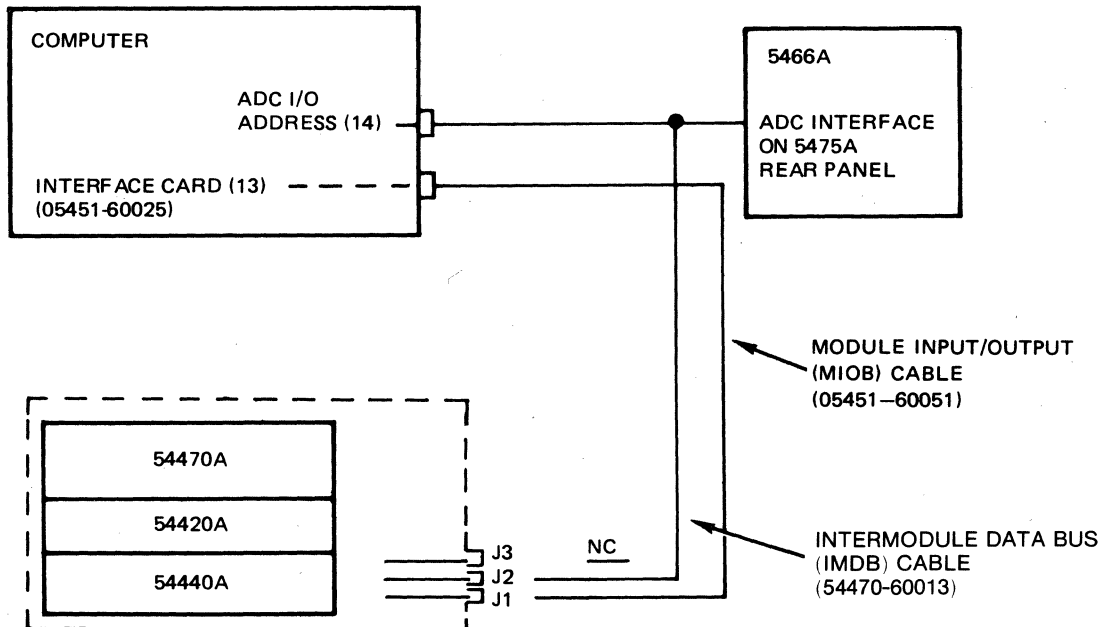

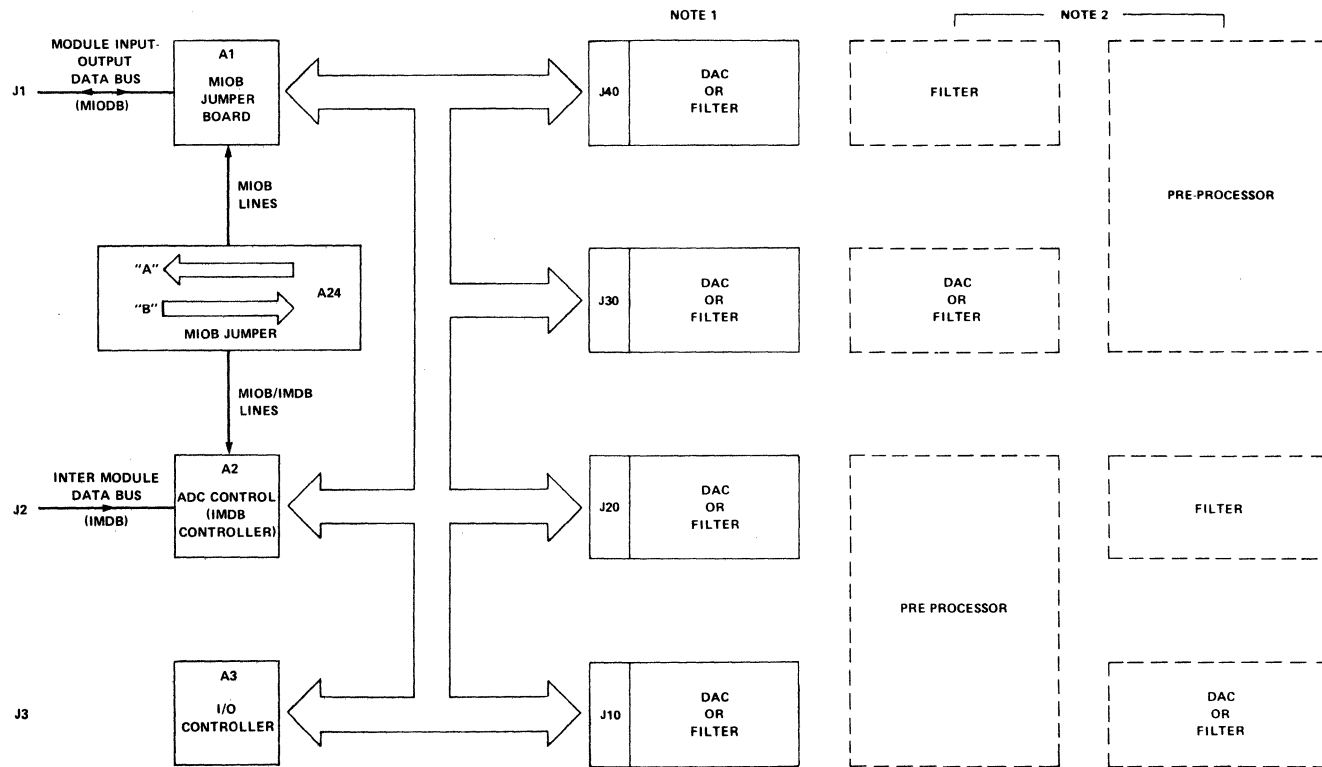

NOTE 1

NOTE 2

NOTE:

- 1- MIOB JUMPER IN "A" POSITION
 - a- DAC OR FILTER CAN BE IN ANY SLOT.
- 2- MIOB JUMPER IN "B" POSITION
 - a- DAC TO BE IN SLOTS J10 OR J30 ONLY.
 - b- FILTER CAN BE IN ANY SLOT.
 - c- PRE-PROCESSOR CAN BE IN EITHER HALF OF MAINFRAME BY REMOVING DIVIDERS BETWEEN J10 & J20 OR J30 & J40.

MIOB Jumper Table

OPERATIONAL DEMONSTRATION

Equipment Required

- o Sinewave Generator
 - Output frequency: 300 Hz +/- 2 Hz
 - Output level: between 1-2V peak
- o Cable (BNC to BNC) to connect sinewave generator to 5466B

Equipment Setup

- o General Setup
 1. Connect the sinewave generator OUTPUT to the 5466B CHANNEL A INPUT.
 2. Set the sinewave generator frequency controls for an output frequency of 300 Hz
- o 5466B Setup
 1. SAMPLE MODE to kHz/us
 2. TRIGGER SOURCE to FREE RUN
 3. MULTIPLIER to 500/2/1 (where Fmax is 1kHz)
 4. INPUT SELECTOR to A
 5. CHANNEL "A" OVERLOAD VOLTAGE to 2
- o 5460A Setup
 1. DISPLAY TYPE to CONT
 2. FUNCTION to DISPLAY
 3. All other controls to UP or center position

Procedure

The Test Procedure is dependent upon the following keyboard programs. Press the following keys:

```

REPLACE 0 ENTER
LABEL 0 ENTER
BLOCK SIZE 512 ENTER
ANALOG IN ENTER
F ENTER
POLAR ENTER
DSPLY 0 SPACE 4 ENTER
JUMP 0 ENTER
LABEL 1 ENTER
USER PROG 40 SPACE 0 ENTER
USER PROG 45 SPACE 1 SPACE 1 ENTER
LOG MAG 1 ENTER
DSPLY 1 ENTER
USER PROG 40 SPACE 300 SPACE 25 ENTER
USER PROG 45 SPACE .1 SPACE 1 ENTER
LOG MAG 1 ENTER
DSPLY 1 ENTER
JUMP 1 ENTER
END ENTER
TERM ENTER

```

To check the resident Keyboard program, press LIST ENTER and compare the results with those below.

```

1  L      0
5  BS    512
9  RA
12 F
15 TP
18 D      0      4
23 J      0
27 L      1
31 Y     40      0
36 Y     45      1      1
42 TL     1
46 D      1
50 Y     40     300     25
56 Y     45      1      1
62 TL     1
66 D      1
70 J      1
74 .

```

The keyboard program just entered will be used to set up the oscillator output frequency and amplitude in addition to verifying the 54470A operation.

Press the following keys on the Keyboard in the following sequence :

Action or Results

JUMP 0 ENTER

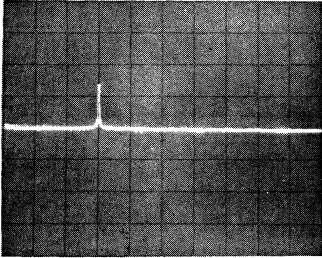

The CRT will "flash" the Log Magnitude of the oscillator output. Adjust the oscillator amplitude until the "pulse" on the CRT is 1-1/2 cm high. Then adjust the oscillator frequency until the signal is positioned to the 3rd cm from the left of the CRT. The CRT should look as shown at the left.

RESTART

This reinitializes the keyboard stops the measurements.

JUMP 1

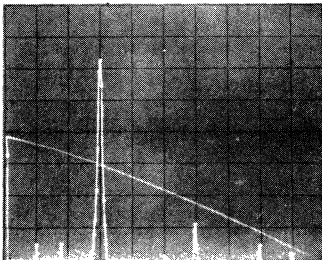

This command will set up the system to make a Baseband measurement with the following information displayed on the Terminal and CRT.

Observe:

BASEBAND	HZ/DIV:	100.00	
DF	0003.906 250:	BLOCKS LEFT	56*
ZOOM POWER:	1		

*NOTE - BLOCKS LEFT VARY WITH MEMORY AVAILABLE.

Press:

CONTINUE

The keyboard program now makes a ZOOM measurement with the following information displayed on the on the Terminal and CRT.

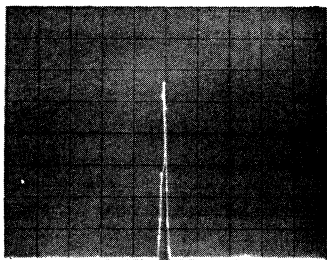

Observe:

CNTR FREQ:	0299.9878	HZ/DIV	3.125
DF*	0000.12207039	BLOCKS LEFT:	55*
ZOOM POWER:	32		

*NOTE - BLOCK LEFT VARY
WITH MEMORY AVAILABLE.

The displayed results may vary because of distortion of the oscillator. If the signal is not centered on the CRT it is because the oscillator is not set exactly to 300 Hz.

This ends the operational demonstration of the 54470A Pre-Processor.

