



AMD
303A-004 P/T ADAPTER

981-0133-003 REV C

FEBRUARY 85

Copyright © Data I/O Corporation, 1985. All rights reserved.

Data I/O has made every attempt to ensure that the information in this document is accurate and complete. However, Data I/O assumes no liability for errors, or for any damages that result from use of this document or the equipment that it accompanies.

Data I/O reserves the right to make changes to this document without notice at any time.

NOTE

Before using this adapter, read the LogicPak™ manual.*

**LogicPak™ and Logic Fingerprint™ are trademarks of Data I/O Corporation.*

Applies to: Engineering Part No. 715-0038-003

Text Reference No. 090-0051

TABLE OF CONTENTS

SECTION 1. INTRODUCTION

1.1 OVERVIEW	1-1
1.2 APPLICATIONS	1-2
1.3 DEVICE-SPECIFIC INFORMATION (Logic Fingerprint™ Test Limitations)	1-2
1.4 SPECIFICATIONS	1-5
1.5 FIELD APPLICATIONS SUPPORT	1-5
1.6 WARRANTY	1-6
1.7 SERVICE	1-6
1.8 ORDERING	1-6

SECTION 2. INSTALLATION

2.1 INSPECTION	2-1
2.2 ADAPTER INSTALLATION	2-1
2.3 ADAPTER REMOVAL	2-1
2.4 REPACKING FOR SHIPMENT	2-2

SECTION 3. OPERATION

3.1 OVERVIEW	3-1
3.2 POWER UP	3-4
3.3 POWER DOWN	3-5
3.4 BASIC DATA TRANSFER OPERATIONS	3-5
3.4.1 FAMILY CODE AND PINOUT CODE SELECTION	3-5
3.4.2 DEVICE INSERTION	3-6
3.4.3 DEVICE REMOVAL	3-6
3.4.4 LOAD RAM WITH MASTER DEVICE DATA	3-6
3.4.5 PROGRAM DEVICE WITH RAM DATA	3-8
3.4.6 VERIFY AND FUNCTIONALLY TEST DEVICE	3-10
3.5 SYSTEM COMMANDS	3-11
3.5.1 ENABLE TERMINAL MODE	3-13
3.5.2 DISPLAY COMMAND MENU	3-13
3.5.3 FAMILY CODE AND PINOUT CODES	3-13
3.5.4 SET REJECT COUNT OPTION	3-14
3.5.5 SELECT VERIFY OPTION	3-14
3.5.6 SELECT SECURITY FUSE OPTION	3-16
3.5.7 ENTER FUNCTIONAL TEST DATA	3-17
3.5.8 DISPLAY FUSE PATTERN	3-22
3.5.9 JEDEC FORMAT DATA EXCHANGE	3-24
3.5.10 EDIT FUSE PATTERN	3-30
3.5.11 DISPLAY CONFIGURATION NUMBER	3-33
3.5.12 SELECT ATTRIBUTES	3-34
3.5.13 EXIT COMMANDS	3-35

SECTION 4. CALIBRATION AND TROUBLESHOOTING

4.1 OVERVIEW	4-1
4.2 CALIBRATION	4-1
4.2.1 DC CALIBRATION (STEPS 1 THROUGH 10 AND 12)	4-2
4.2.2 WAVEFORM OBSERVATION	4-6
4.2.3 EXPLANATION OF TIMING DIAGRAMS	4-6

SECTION 5. CIRCUIT DESCRIPTION

5.1 INTRODUCTION	5-1
5.2 GENERAL ARCHITECTURE	5-1
5.3 COMPONENT LAYOUT	5-1

APPENDIX A. LOGIC DIAGRAMS AND PLDS FAMILY AND PINOUT CODES

LIST OF FIGURES

1-1 303A-002 AMD Programming/Testing Adapter	1-1
1-2 Example of Limitation 1	1-3
1-3 Example of Limitation 2	1-4
1-4 Example of Limitation 2 With Truth Table and Boolean Equations	1-5
2-1 Adapter Installation	2-1
3-1 Automatic Programming Sequence Flow Chart	3-2
3-2 Programmer Power Switch Location	3-4
3-3 Device Installation	3-6
3-4 Operational Overview Flow Chart	3-12
3-5 Fuse Pattern PLDS Command Menu	3-13
3-6 Prompts for Entering Functional Test Data	3-19
3-7 Entering Functional Test Data	3-20
3-8 Complete Fuse Pattern	3-22
3-9 Logic Diagram for Basic Gates Example	3-23
3-10 JEDEC Transmission—Basic Gates Example	3-24
3-11 JEDEC Format (Breakdown of Figure 3-10)	3-25
3-12 Computing the Transmission Checksum	3-26
3-13 Computing the Fuse RAM Checksum	3-27
3-14 Default Fuse Editor Pattern	3-32
3-15 Starting Fuse Not on Row Boundary	3-33
4-1 LogicPak™ Cover Removal	4-1
4-2 Calibration Equipment Setup	4-1
4-3 LogicPak™ Test and Adjustment Locations	4-3
4-4 Sample Timing Diagram	4-7
5-1 Typical Programming/Testing Adapter Block Diagram	5-1
A-1 Logic Diagram AmPAL16H8	A-4
A-2 Logic Diagram AmPAL16HD8	A-5
A-3 Logic Diagram AmPAL16L8	A-6
A-4 Logic Diagram AmPAL16LD8	A-7
A-5 Logic Diagram AmPAL16R4	A-8
A-6 Logic Diagram AmPAL16R6	A-9
A-7 Logic Diagram AmPAL16R8	A-10
A-8 Logic Diagram AmPAL22V10	A-11

LIST OF TABLES

1-1 Using the AMD Programming/Testing Adapter Manual	1-1
1-2 Logic Fingerprint™ Test Limitations for AMD Programmable Logic Devices	1-2
3-1 PLDS Command Summary	3-3
3-2 Vector Editor Command Characters	3-20
3-3 Vector Symbol Definition	3-21
3-4 Translator Input Errors	3-28
3-5 ASCII Values of Field Identifiers	3-28
3-6 Translator Input Error Codes	3-29
4-1 Key Sequence To Access the Calibration Mode	4-3
4-2 PLDS Error Codes	4-4
4-3 Measurement Chart	4-9
4-4 Error Codes for Calibration	4-42
A-1 AMD Device List	A-3

SECTION 1 INTRODUCTION

1.1 OVERVIEW

The 303A-004 Advanced Micro Devices (AMD) programming/testing (P/T) adapter consists of two zero-insertion-force sockets with interface circuitry and EPROM (erasable, programmable read-only memory) mounted in a metal frame; see figure 1-1. The P/T adapter is used with the Data I/O 303A LogicPak™ to match programming electronics to the specific device family you are using. Any firmware unique to the AMD programmable logic devices is resident in the EPROM on the P/T adapter; all other necessary firmware is in the LogicPak™ or the programmer.

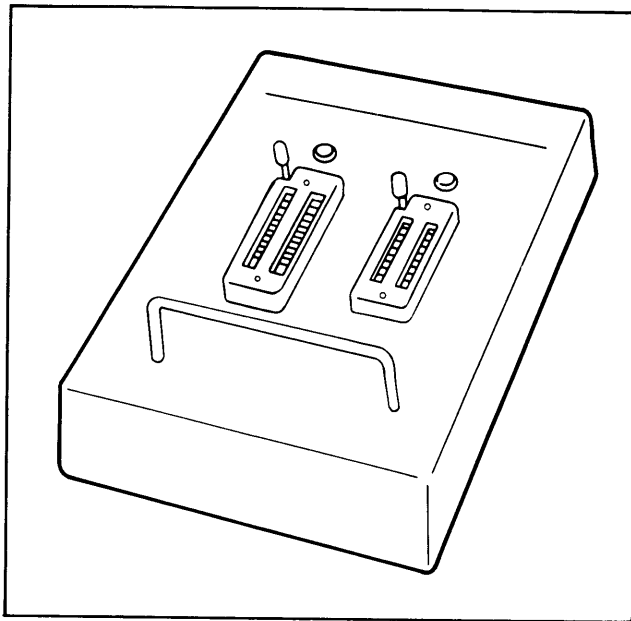

Figure 1-1. 303A-004 AMD Programming/Testing Adapter

This manual describes how to use the AMD P/T adapter. Subjects addressed in this manual and their corresponding subsections are listed in table 1-1. Use this table as a quick-reference point for the major sections.

In this manual, we will refer to the operational procedures for the Model 29 Universal Programmer; refer to your programmer manual for System 19 and 100A key sequences.

The entries that you are to make from either the programmer or terminal are indicated by the symbol shown below:



**TERMINAL
MODE**



**PROGRAMMER
FRONT PANEL**

Table 1-1. Using the AMD Programming/Testing Adapter Manual

SUBJECT	SECTION
Applications	1.2
Installation procedures for P/T adapter	2.2
Basic operation instructions	3.0
System commands	3.5
Calibration	4.2
Measurement chart for DC calibration tests	4.2
Error codes	4.2
Timing diagrams	4.2
Circuit description	5.0
Family and pinout codes	Appendix A
Logic diagrams	Appendix A
Data I/O Service Centers	Back of manual
Warranty information	Back of manual

The following key sequence indicates that the escape (ESC) key on the terminal keyboard should be pressed.



1.2 APPLICATIONS

Software tables resident within the P/T adapter store values for programming variables, including pinouts, voltage levels, and timing. When you choose the family and pinout codes for a particular device, the programmer uses information in these tables to assemble a specialized programming routine in scratch RAM (random-access memory). This allows high-speed operation with minimum firmware.

The family code and pinout code table (table A-1, appendix A) lists all the devices that can be programmed and/or tested with this P/T adapter. Table A-1 also lists the development aids as well as the family and pinout code corresponding to each device. This table will be updated as new devices are added. As Data I/O increases the capabilities of the LogicPak™ to program new devices, firmware and/or hardware updates will be available for existing adapters to add new devices to existing device families. New adapters will also be added to accommodate new-device families. Contact Data I/O for the latest revision and any required firmware updates.

If a fuse pattern is generated on a host system, it must use fuse numbers specified according to the logic diagrams in this manual and transmitted to the programmer in the JEDEC (Joint Electron Device Engineering Council) format (see appendix A of the LogicPak™ manual). Data I/O uses the JEDEC Logic Device Translation Format (number JC-42, 1-81-62) for serial data input and output with the LogicPak™. The only exception to this is when you are using a Signetics H&L design adapter, in which case data transfer can also occur in the Signetics H&L logic format.

NOTE

Before operating, see the JEDEC format specifications limitations in the LogicPak™ manual, appendix A, and section 3.

1.3 DEVICE-SPECIFIC INFORMATION (LOGIC FINGERPRINT™ TEST LIMITATIONS)

The pseudo-random nature of the input vectors generated during the Logic Fingerprint™ test can cause some devices in some programming circumstances to fail by giving nonrepetitive results. This does not necessarily indicate a faulty device, but may be an indication that the device is subject to Logic Fingerprint™ test limitations. The device may still function in the system for which it was designed. The error flag indicating the Logic Fingerprint™ test failed is alerting you that this programmed pattern may not function for all possible input states.

Table 1-2 lists the devices and their Logic Fingerprint™ test limitations. Limitation 1 occurs when devices are programmed so that nonregistered outputs are fed back to product inputs, which results in an oscillation. This condition is shown in the simplified example in figure 1-2. The two nonregistered product outputs (pins 18 and 19) in figure 1-2 feed back to the other product's input. If input pins 2 and 3 are both true (i.e., TTL "1"), the PAL will oscillate. This condition could exist for one product output feeding back to its own input or numerous outputs feeding back.

NOTE

The AmPAL22V10 has two pinout codes. Pinout code 28 treats pin 1 as if it were a clock during the Logic Fingerprint™ Test and pinout code 83 treats pin 1 as an input.

Table 1-2. Logic Fingerprint™ Test Limitations for AMD Programmable Logic Devices

Part Numbers	Logic Fingerprint™ Test Limitations
AmPAL 16H8	1,2
AmPAL 16HD8	1,2
AmPAL 16L8	1,2
AmPAL 16LD8	1,2
AmPAL 16R4	1,2
AmPAL 16R6	1,2
AmPAL 16R8	1,2
AmPAL 22V10	1,2

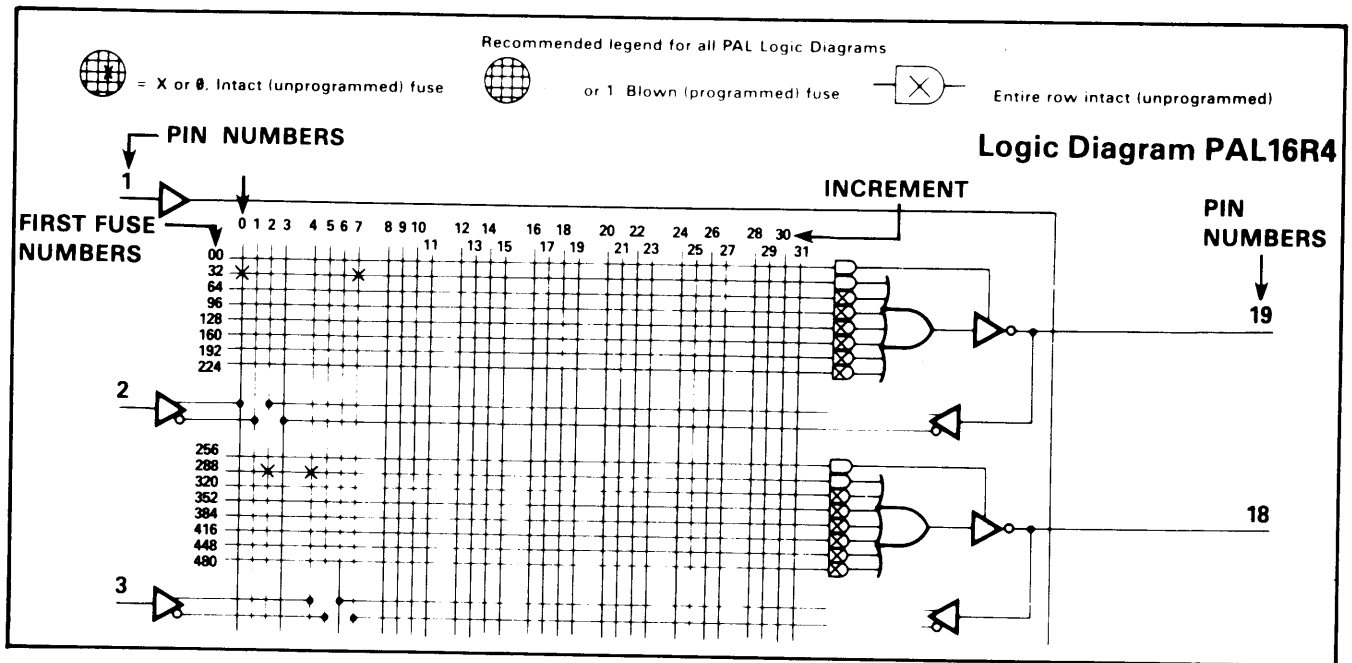

Figure 1-2. Example of Limitation 1

Limitation 2 occurs when a race condition is programmed into the device. Because the inputs are controlled, it is possible that the race condition will not be critical in the circuit for which the device was designed. Due to the random nature of the inputs during the Logic Fingerprint™ test, the race condition could appear and cause unstable results. An RS latch is an example of this. Figures 1-3 and 1-4 show the schematic, truth table, Boolean equations, and fuse map. Suppose that A, B, and C are at logic lows, 01 is at a logic high, and 02 is at a logic low. Let B and C go to a logic high simultaneously. The state of S will depend on how fast B and C can propagate through the logic gates. The effect of B will arrive at S first, forcing it low. At a time equal to the propagation delay of the gates later, the effect of C will be seen at S, forcing it back to a

logic high. When S was at a logic low, the RS latch changed state and is unaffected when S comes back high. This causes the Logic Fingerprint™ test to read the wrong values on the outputs, which in turn causes an unstable result.

If the default starting vector of 0 results in a test-sum of FFFFFFFF, select a starting vector other than 0.

NOTE

It is important that you recognize when devices are programmed with these limitations and realize that the Logic Fingerprint™ test will reject them. These devices can still be tested by using structured test vectors.

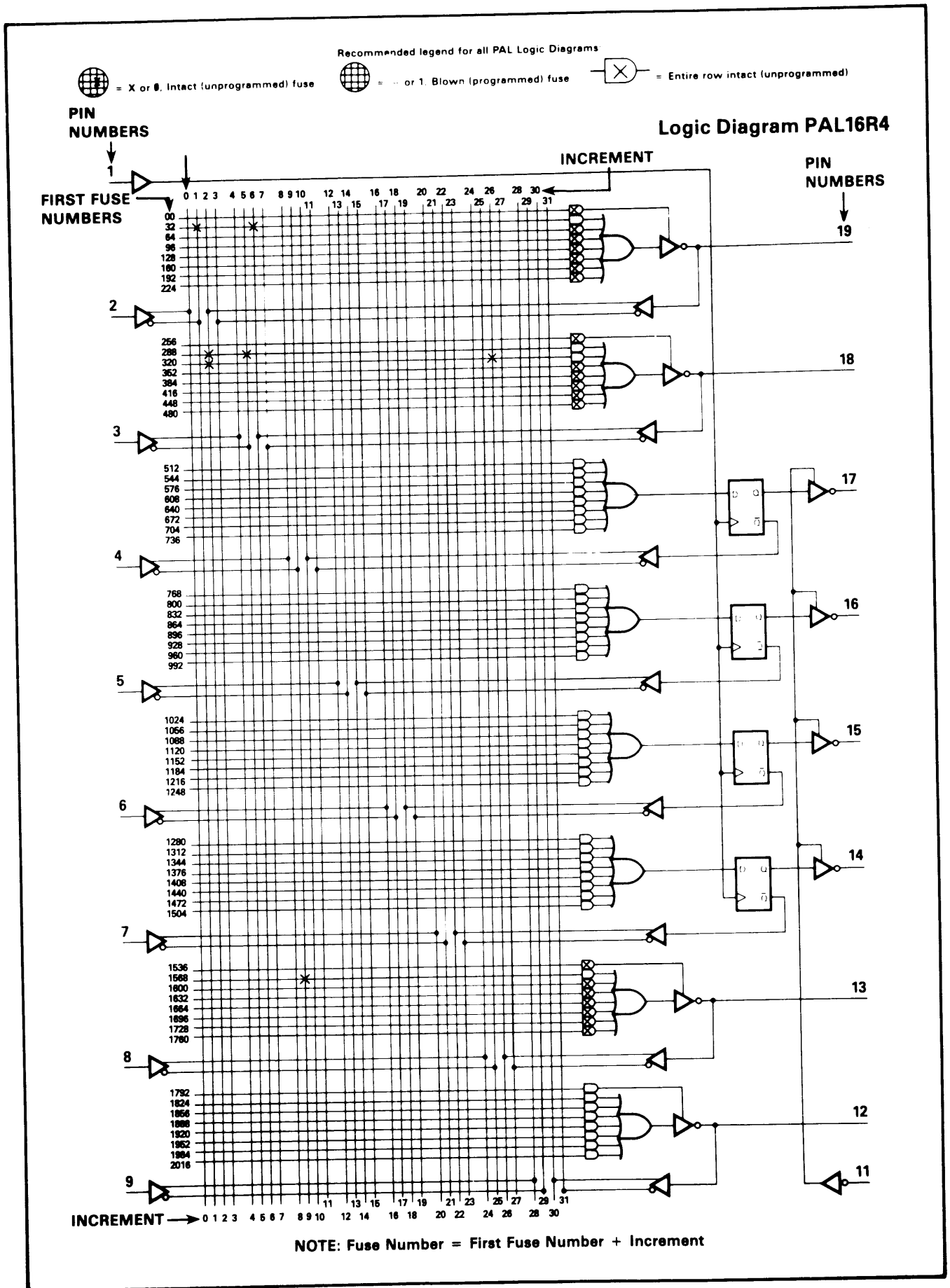

Figure 1-3. Example of Limitation 2

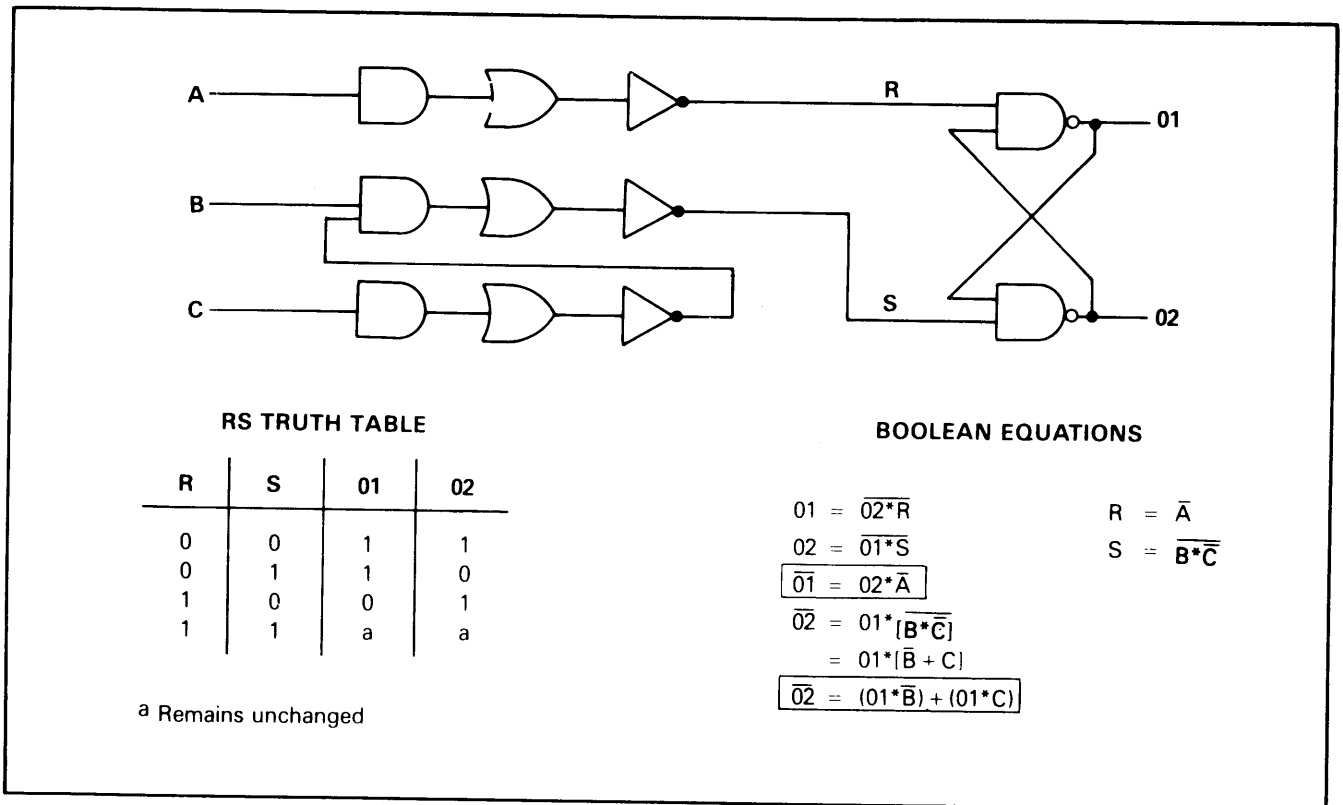

Figure 1-4. Example of Limitation 2 With Truth Table and Boolean Equations

1.4 SPECIFICATIONS

The P/T adapter receives its power from the LogicPak™ and the programmer power supplies. Programming waveforms are generated from programmer supplies using the digital-to-analog converters (DAC) controlled by the programmer's microprocessor. The controlling firmware is located both on a circuit board in the LogicPak™ and in the P/T adapters. The physical and environmental specifications of the P/T adapter are:

- Altitude (operating): sea level to 3 km (10,000 ft)
- Humidity (operating): 90% maximum (noncondensing)
- Humidity (storage): 95% maximum (noncondensing)
- Temperature (operating): +5 to 45°C (41 to 113°F)
- Temperature (storage): -40 to 70°C (-40 to 158°F)
- Weight: 0.255 kg (9 oz)
- Dimensions: 16.6 x 12.3 x 2.1 cm (6.54 x 4.84 x 0.81 in.)

1.5 FIELD APPLICATIONS SUPPORT

Data I/O has field applications engineers throughout the world. They can provide additional information about interfacing Data I/O products with other systems and answer questions about your equipment.

The engineers within the United States are located at the addresses listed in the back of this manual. For international applications support, contact your nearest Data I/O representative.

1.6 WARRANTY

The 303A-004 P/T adapter is warranted against defects in materials and workmanship. The warranty period of one year begins when you receive the equipment; the warranty card inside the back cover of this manual explains the length and conditions of the warranty. For warranty service, contact your nearest Data I/O service center.

1.7 SERVICE

Data I/O maintains service centers throughout the world, each staffed with factory-trained technicians to provide prompt, quality service. A list of all service centers is located in the back of this manual.

1.8 ORDERING

To place an order for equipment, contact your Data I/O sales representative. Orders for shipment must include:

- A description of the equipment. (See the latest Data I/O price list or contact your sales representative for equipment and part numbers.)
- Purchase order number.
- Desired method of shipment.
- Quantity of each item ordered.
- Shipping and billing address of the firm, including ZIP code.
- Name of person ordering the equipment.

SECTION 2 INSTALLATION

2.1 INSPECTION

The P/T adapter was thoroughly tested and inspected before shipment and was carefully packaged to prevent shipping damage. Inspect your adapter to ensure that no damage occurred during shipment. If you notice any damage, file a claim with the carrier and notify Data I/O.

2.2 ADAPTER INSTALLATION

To insert the P/T adapter into the LogicPak™:

1. Check to make sure a device is not in the socket. If a device is in the socket, remove it as described in subsection 3.4.3.
2. Align the guide pins on the underside of the adapter with the guide pin holes on the LogicPak™ (see figure 2-1).
3. Gently set the adapter on the LogicPak™.
4. Firmly press down on the front edge of the adapter to lock the connector pins into the connector receptacle (see figure 2-1).

2.3 ADAPTER REMOVAL

CAUTION

Before removing the adapter, you must return control to the programmer. This is done by pressing *ESC* at the terminal, *KEYBOARD* on the System 19, or *VERIFY* on the 100A or Model 29. Because the processor in the programmer executes firmware resident in the adapter, these precautions must be taken before removing the adapter from the LogicPak™ to prevent program interruption and possible loss of RAM data.

To remove the adapter:

1. Ensure that the programmer has completed the current operation.
2. Ensure that a device is not in a socket.
3. While holding down the LogicPak™, grasp the adapter handle and gently remove the adapter.

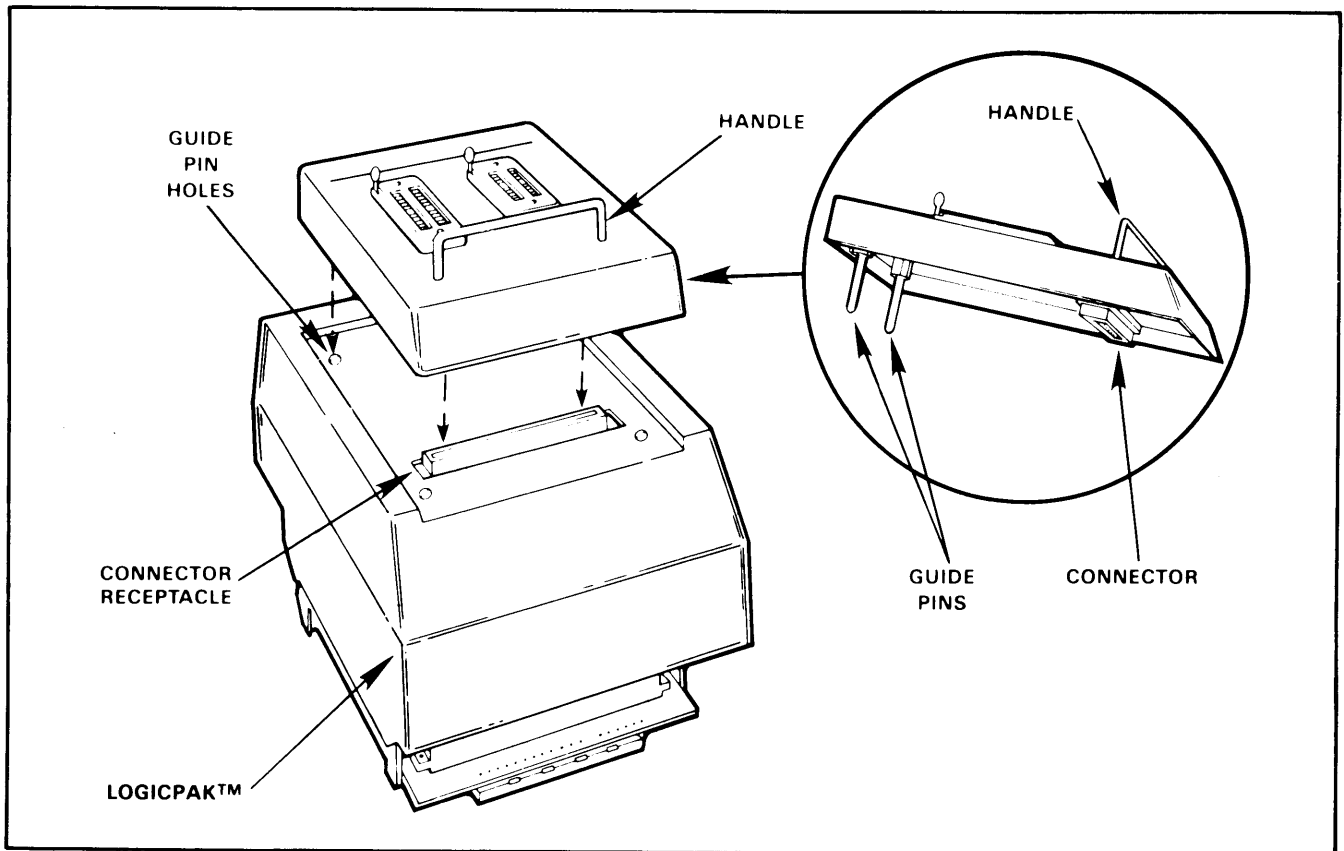

Figure 2-1. Adapter Installation

2.4 REPACKING FOR SHIPMENT

If the adapter is to be shipped to Data I/O for service or repair, attach a tag to it describing the work required and identifying the owner. In correspondence, identify the unit by part number, revision level, and the name of the unit. If the original shipping container is to be used, place the

adapter in the container with the appropriate packing materials, and seal the container with strong tape. If another container is used, be sure that it is a heavy carton, wrapped with heavy paper or plastic; use appropriate packing material, and seal well with strong tape. Mark the container "DELICATE INSTRUMENT" or "FRAGILE."

SECTION 3

OPERATION

3.1 OVERVIEW

The 303A-004 P/T adapter enables you to program and functionally test the AMD devices listed in table A-1 of appendix A. These logic devices are arrays of gates and flip-flops joined by matrices of fusible links. The devices can be programmed by blowing selected fuses in the matrices, which leaves the remaining intact connections to perform the desired logic functions.

The fuse pattern necessary to program a device should already have been developed using a Data I/O LogicPak™ and a design adapter or a host computer system; if you have not developed your fuse pattern, consult the LogicPak™ manual and design adapter manual to develop your data before proceeding. However, if you have entered your data in Boolean equations or function tables (truth tables), they must be translated into a fuse pattern before you can begin programming. (Don't turn the power off; if you do, you will lose all your data.) If you have not used a design adapter, the fuse pattern must be loaded from: 1) a master device, 2) the serial port, or 3) manually from a programmer or terminal keyboard.

An alternate method of specifying the fuse pattern is to manually enter the fuse number and state for every fuse in the device. Appendix A contains logic diagrams for the AMD devices in its repertoire. These are the same as those in the device manufacturer's data book, but the fuse numbers have been added. Although the method is tedious, fuse numbers and states can be entered manually into the programmer's data RAM from the programmer's keyboard or from a terminal. This method usually will be used only for editing fuse data because it is a long process with room for error.

With a P/T adapter, fuse data can be entered into the programmer's RAM by loading from a master device. Blank devices can then be programmed using the same P/T adapter, or other manufacturers' functionally equivalent second-source devices can be programmed by installing the appropriate P/T adapter.

Programming is controlled either from the programmer keyboard or from a terminal. Firmware in the P/T adapter automatically tests the device's position in the socket, ensures that the device is blank, and looks for illegal bits; figure 3-1 defines the overall fuse programming sequence. Programming begins when these automatic checks are completed and determined acceptable.

After the device has been programmed, it is automatically verified and tested according to options you select. See subsection 3.5.5.

In addition to enabling you to program and test devices, the P/T adapter also enables you to view data, change them, and/or enter test parameters. These optional steps are listed in table 3-1. The functions of the P/T adapter are described in table 3-1 and subsection 3.5. Sections 1 and 3 of the LogicPak™ manual also describe these functions. Logic diagrams with decimal fuse numbers are in appendix A of this manual.

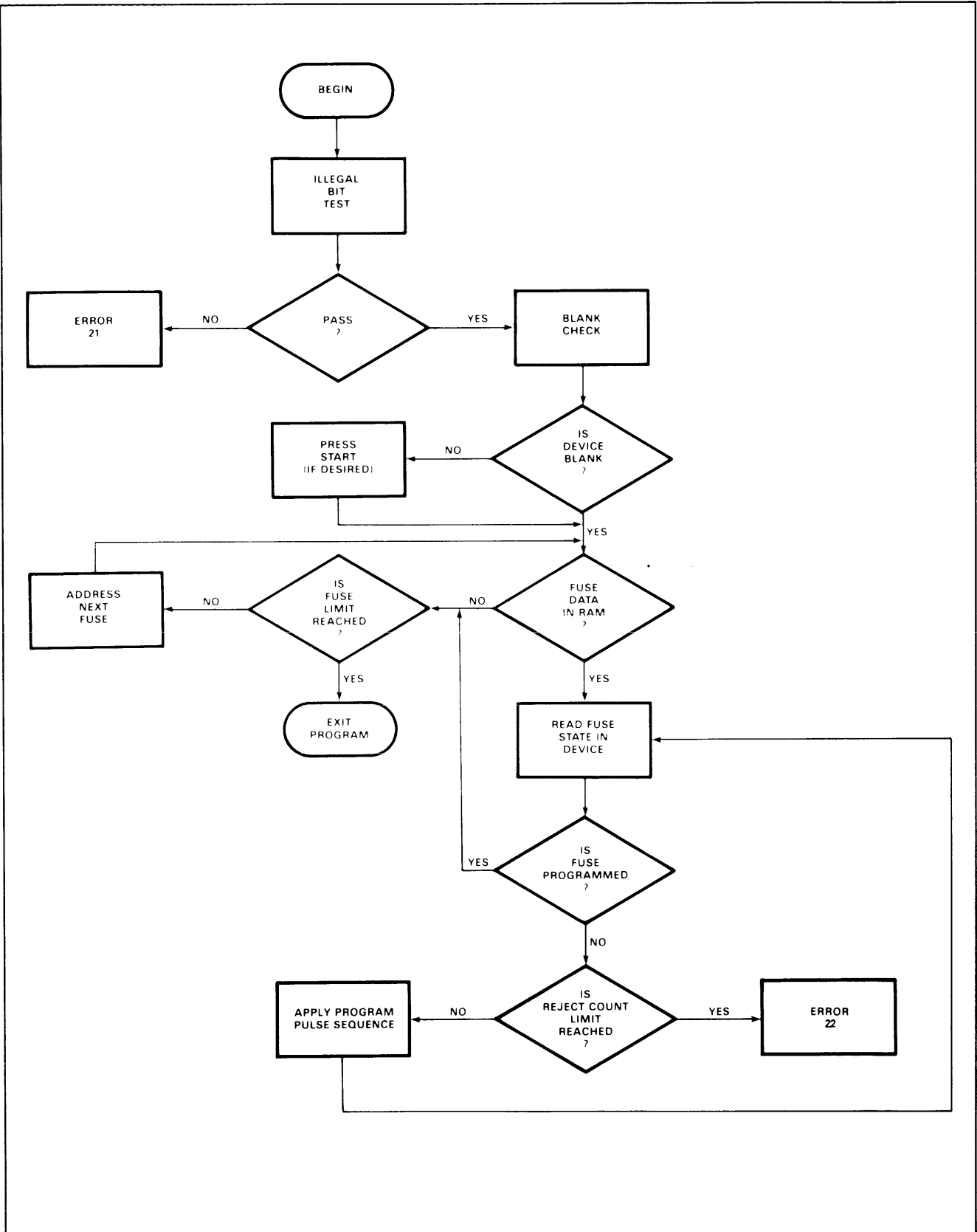

Figure 3-1. Automatic Programming Sequence Flow Chart

Table 3-1. PLDS Command Summary

MODULE OR ADAPTER	COMMAND TYPE	FROM FRONT PANEL	VIA TERMINAL	COMMAND DESCRIPTION	SEE SUBSECTION	
LogicPak™ (with any adapter)		--	0	Display menu	3.5.2	
		E 1	--	Enable terminal mode	3.5.1	
		--	1	Enter family code and pinout code	3.5.3	
		E 5 ^a	5 ^a	Enter reject count option	3.5.4	
		E 6	6	Enter verify option	3.5.5	
		E 7	7	Enter security fuse option	3.5.6	
		E 8	8	Set number of Logic Fingerprint™ test cycles	3.5.7	
		E 9	8	Enter starting vector and test-sum	3.5.7	
		--	8	Enter structured test vectors	3.5.7	
				0	Display menu	3.5.7
				D	Delete current vector	3.5.7
				R	Repeat current vector	3.5.7
				U	Display previous vector	3.5.7
				#(N)	Go to vector (N)	3.5.7
				space	Move cursor right	3.5.7
				backspace ^b	Move cursor left	3.5.7
				return	Display next vector	3.5.7
				CTRL Z	Exit vector editor	3.5.7
			E A	A	Display fuse pattern	3.5.8
			E B	B	Receive JEDEC data	3.5.9
			E C	C	Transmit JEDEC data	3.5.9
			E D	D	Display sum-check of fuse data	3.5.9
			E E	--	Edit fuse by number	3.5.10
	--	E	Edit fuse pattern	3.5.10		
			0	Display menu	3.5.10	
			#(N)	Go to fuse (N)	3.5.10	
			space	Move cursor right	3.5.10	
			backspace ^b	Move cursor left	3.5.10	
			return	Display next row	3.5.10	
			CTRL Z	Exit fuse editor	3.5.10	
	E F	F	Display configuration number	3.5.11		
	E G	G	Set option attributes	3.5.12		
	--	ESC	Exit terminal control before removing adapter	3.5.13		
^a Except with PALASM adapter.						
^b CTRL H is the same as backspace.						
PALASM Design Adapter	Development	--	0	Display menu	Refer to PALASM Design Adapter Manual	
		--	1	Enter family and pinout codes		
		E 2	2	Receive PALASM source		
		E 3	3	Transmit PALASM source		
		E 4	4	Assemble PALASM source		
		E 5	5	Simulate function table		
		--	9	Edit source		
				0		Display menu
				B		Display line 1
				C		Change text
			D	Delete character		
			E	Display to end		
			I	Insert/enter text		
			K	Delete current line		
			L	Display 24 lines		
			R(M)(N)	Repeat M lines after N		
			U	Display previous line		
			# (N)	Go to line N		
			space bar	Move cursor/prompt right		
			back space ^b	Move cursor/prompt left		
			return	Display next line		
			DEL/RUB	Delete characters (I mode)		
			CTRL P	Purge all text		
		CTRL Z	Exit editor, C or I mode			
		ESC	Exit terminal control before removing adapter			
^b CTRL H is the same as backspace.						

NOTE: ESC (escape) returns control to programmer front panel.

(Continued)

Table 3-1. PLDS Command Summary (Con't.)

MODULE OR ADAPTER	COMMAND TYPE	FROM FRONT PANEL	VIA TERMINAL	COMMAND DESCRIPTION	SEE SUBSECTION
H&L Design Adapter	Development	--	0	Display menu	Refer to H&L Design Adapter Manual
		--	1	Enter family and pinout codes	
		E 2	2	Receive data (IFL format) ^c	
		E 3	3	Transmit data (IFL format)	
		--	4	Edit mode	
	Edit	--	G	Enter gate number	
		--	P	Enter product term number	
		--	T	Enter transition term number	
		--	V	Move cursor forward	
		--	V	Move cursor backward	
		--	F	Display next term	
		--	R	Display last term	
		--	N	Enter next field	
		--	I	Insert term	
		--	D	Delete term	
Integrated fuse logic, Signetics ASCII	--	C	Clear term		
	--	X	Deactivate term		
	--	E	Display edit sub-menu		
	--	0	Exit edit mode		
	--	1	Return to edit mode		
	--	2	Serial input (receive IFL format) ^c		
	--	3	Serial output (transmit IFL format)		
	--	4	List low-order terms		
	--	5	List high-order terms		
	--	6	Compress terms		
		--	CTRL Z	Exit edit mode	
		--	ESC	Exit terminal control before removing adapter	
All P/T Adapters	Device	--	1	Enter family code and pinout code	3.4.1
		Load	2	Load fuse data from device to RAM	3.4.4
		Verify	3	Verify fuse data and perform functional test	3.4.6
		Program	4	Program device with RAM data	3.4.5

NOTE: ESC (escape) returns control to programmer front panel

3.2 POWER UP

NOTE

If the LogicPak™ with an adapter installed is not in the programmer before power is turned on, you will hear a beep until the LogicPak™ is installed.

When power is applied, the programmer will perform an automatic self-test routine (see subsection 1.4.3 of the LogicPak™ manual). When the self-test routine is complete, the programmer will signal its readiness (see your programmer manual).

To turn the programmer on:

1. Check to make sure a device is not in the socket. If a device is in the socket, lift up the lever (on the upper left of the socket; see subsection 3.4.3), then gently lift the device out of the socket.
2. Plug the AC power cord into the power outlet.
3. Lift the power switch up to the *ON* position (see figure 3-2).

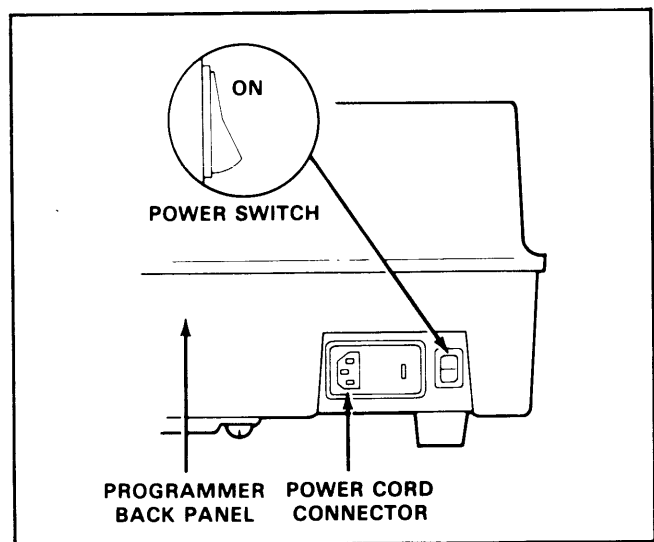

Figure 3-2. Programmer Power Switch Location

3.3 POWER DOWN

CAUTION

Do not turn the power off when a device is in the socket; voltage transients may damage the device.

To turn the programmer power off:

1. Check to make sure the programmer is not in an operation process. If it is, wait until the operation is complete.
2. Check to make sure a device is not in the socket. If a device is in the socket, remove it as described in subsection 3.4.3.
3. Push the power switch down to the *OFF* position (figure 3-2).

3.4 BASIC DATA TRANSFER OPERATIONS

The basic operations that can be accomplished with the LogicPak™ and the Model 29 Universal Programmer are:

- develop data (described in subsection 1.4.1 of the LogicPak™ manual and design adapter manuals),
- load RAM with master device data (described in subsection 3.4.4),
- program a device with RAM data (described in subsection 3.4.5),
- verify RAM data against the device data (described in subsection 3.4.6),
- functionally test device (described in subsection 3.5.7).

If the programmer has been used to program PROMs, or contains data in RAM for some other reason, the fuse pattern developed for logic devices could be adversely affected or option parameters could be inadvertently set. Therefore, execute the “clear RAM” select function (see programmer manual), to clear RAM before beginning operations with the PLDS.

The following subsections describe device-related operations with the PLDS using a P/T adapter. Most setup procedures specify that you enter the family and pinout codes because Data I/O recommends that you develop the habit of entering these codes when prompted by the equipment.

All data transfer or verification operations occur between the programmer’s internal RAM and the device or between the RAM and serial port in your programmer. Because the

operation procedure to transfer data via a serial port varies among programmers, this manual describes only data transfer using the Model 29. For other programmers, refer to the specific programmer operation manual.

NOTE

An adapter must be installed in the LogicPak™ before any of these operations can be performed (see subsection 2.2).

During copy and verify operations, ADDR and SIZE appear in the Model 29 prompts. These correspond to starting address and block size, respectively. These block limits must remain in the default state for logic device programming. An error code (see section 4, table 4-2) will be displayed if these limits are altered. For more detail on these parameters, see your programmer manual.

3.4.1 FAMILY CODE AND PINOUT CODE SELECTION

Any device that can be programmed with the LogicPak™ is specified by a unique combination of a two-digit family code and a two-digit pinout code; these codes are provided in appendix A of this manual. Once the codes are entered for a particular device, the LogicPak™ remains set up for any operation with that device until you enter new codes. If invalid family and pinout codes are entered, a beep will sound. In remote control operation,

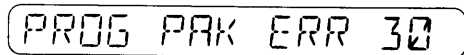

will be displayed, and the operation will be stopped when you attempt a device operation.

To select the family code and pinout code:

1. Locate the manufacturer name and part number stamped on the device.
2. Go to the family code and pinout code table in appendix A and find the manufacturer’s name.
3. Go to the column entitled “Device” and find the number corresponding to the number on the device.
4. Go to the columns labeled “Family” and “Pinout” to find the code numbers corresponding to the device number for the manufacturer of the device. Notice the AmPAL22V10 has two family pinout codes. See subsection 1.3 for an explanation of the difference.
5. Enter the family code and pinout code you selected from this table when prompted by the programmer or terminal. An LED (light emitting diode) will light above the socket on the adapter.

3.4.2 DEVICE INSERTION

Once you have entered the appropriate family and pinout codes, the LogicPak™ with a P/T adapter installed is ready to accept a device in the socket below the lighted LED.

To install a device:

1. Check to make sure the programmer is not doing an operation. If it is, wait until the operation is complete.
2. Lift the lever on the upper-left side of the socket below the lighted LED (see figure 3-3); the lever will stay in the upright position.
3. Gently set the device in the socket below the lighted LED. Make sure pin 1 of the device is aligned with pin 1 of the socket (upper-left corner); see figure 3-3.
4. A good electrical connection between the device and the socket is essential. To ensure a good connection, push the lever down to lock the device in the socket.

3.4.3 DEVICE REMOVAL

To remove a device:

1. Check to make sure the programmer is not doing an operation. If it is, wait until the operation is complete.
2. Lift the lever on the left side of the socket; see figure 3-3. The lever will remain in the upright position.
3. Lift the device out of the socket; the LED will remain illuminated.

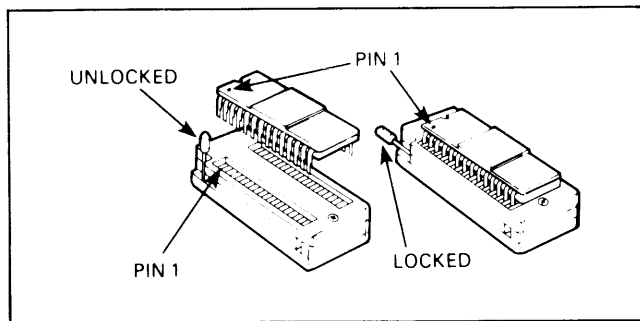

Figure 3-3. Device Installation

3.4.4 LOAD RAM WITH MASTER DEVICE DATA

Front Panel Control

To load the Model 29 RAM with data from a master device with control from programmer front panel, follow the steps given below.

NOTE

If options are desired (see subsection 3.5), select options and parameters as needed before proceeding.

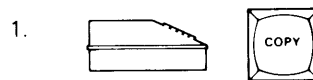

to select the mode.

Model 29 Displays

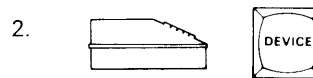
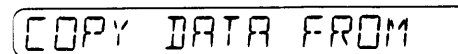

to select the source of the data.

Model 29 Displays

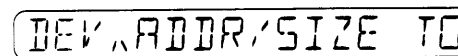

ADDR/SIZE pertains to block limit parameters. These are PROM related and are not to be used with logic devices. Leave defaults in effect.

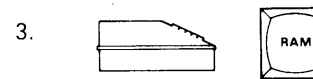

to select the destination for the data.

Model 29 Displays

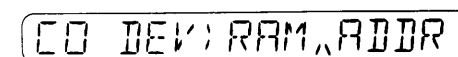



Model 29 Displays

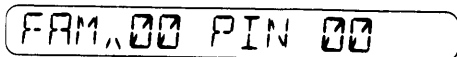

5. Enter the family code and pinout code (see subsection 3.4.1).

NOTE
The socket LED will light.

6. Insert the master device into the appropriate P/T adapter socket. (See subsection 3.4.2.)



Model 29 Displays

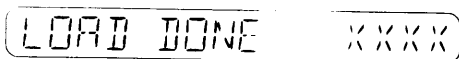
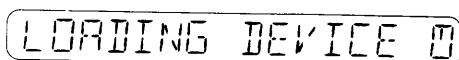

NOTE
XXXX is the sum-check of the device fuses.

8. Remove the master device from the adapter socket. (See subsection 3.4.3.)

Fuse data may also be downloaded from a peripheral via the programmer serial port. (Refer to subsection 3.5.9 for instructions.)

Terminal Control

To load the Model 29 with data from a master device using the terminal control mode, follow the steps given below.

1. Place the system in terminal mode; see subsection 3.5.1.
2. Enter the family code and pinout code at the terminal, if prompted by the terminal display.

NOTE
If options are desired (see subsection 3.5), select options and parameters as needed before proceeding.



Terminal Displays

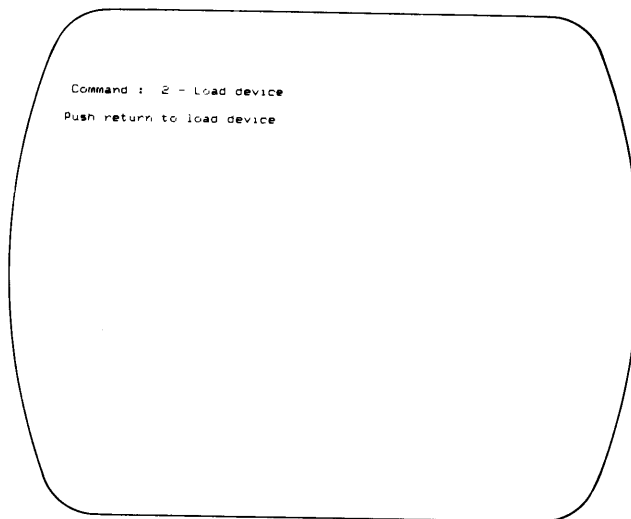

4. Insert master device into socket (see subsection 3.4.2).



Terminal Displays

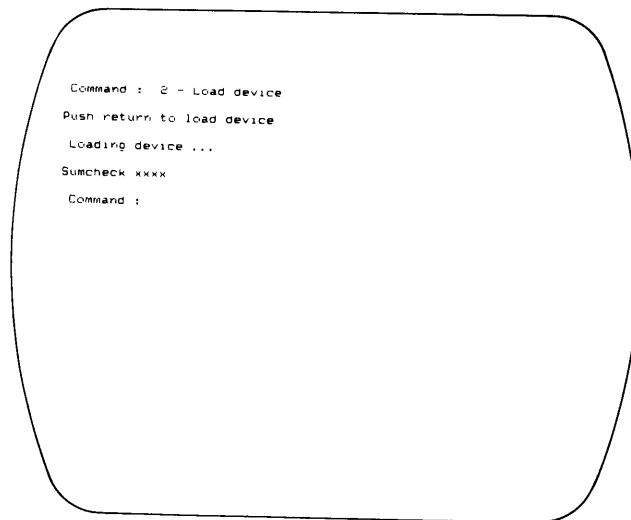

An action symbol will be displayed while the device is being loaded. When loading is complete, the terminal will display sum-check XXXX.

6. Remove device (see subsection 3.4.3).

3.4.5 PROGRAM DEVICE WITH RAM DATA

NOTE

If options are desired (see subsection 3.5), select options and parameters as needed before proceeding.

When programming a device, the system performs illegal-bit tests and blank checks at nominal VCC.

Front Panel Control

To program a blank device with the data in the Model 29 RAM with control from the programmer front panel, follow the steps given below.

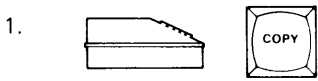

Model 29 Displays

COPY DATA FROM

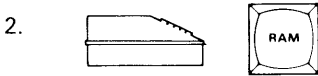

Model 29 Displays

RAM ADDR / SIZE TO

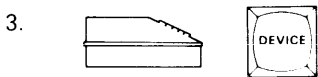

Model 29 Displays

CO RAM; DEV ADDR



Model 29 Displays

FAM. 00 PIN 00

5. Enter the family code and pinout code if required (see subsection 3.4.1).
6. Insert the blank device into the adapter socket (subsection 3.4.2).



Model 29 Displays

TEST DEVICE 0

PROGRAM DEVICE 0

VERIFY DEVICE 0

PRG DONE 01 XXXX

sequence number (increments by 1 for each device programmed) ————
 sum-check ————

8. Remove the device from the adapter socket (see subsection 3.4.3).

Terminal Remote Control

To program a device with Model 29 RAM data from the terminal control mode:

1. Place the system in the terminal mode (see subsection 3.5.1).
2. Enter the family code and pinout code, if prompted by the terminal.

NOTE

If options are desired (see subsection 3.5), select options and parameters as needed before proceeding.

3.



Terminal Displays

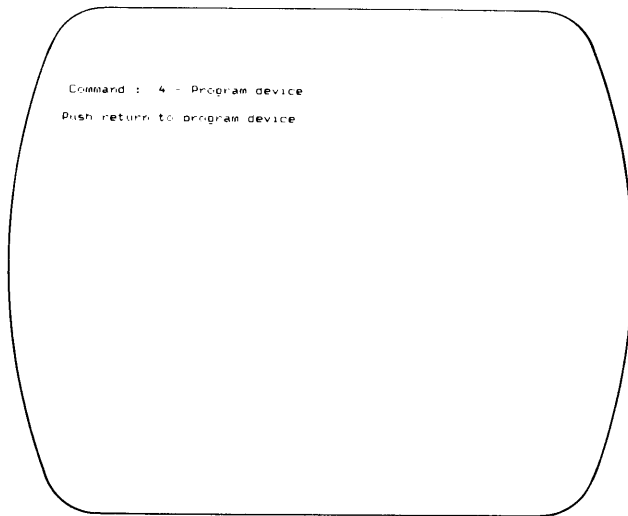

4. Insert device into socket (see subsection 3.4.2).

5.

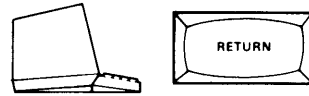

Terminal Displays

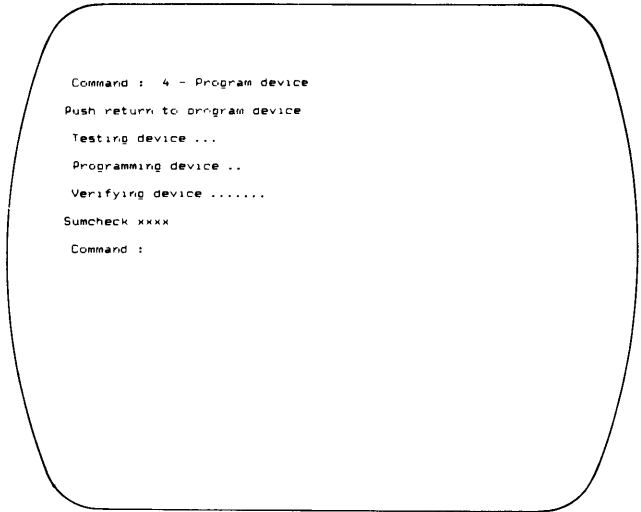

An action symbol will be displayed showing the pretesting, programming and verifying of the part. If no errors occur, the terminal displays sum-check XXXX.

NOTE

XXXX is the sum-check of the device fuses.

6. Remove device (see subsection 3.4.3).

3.4.6 VERIFY AND FUNCTIONALLY TEST DEVICE

Front Panel Control

The verify routine compares the device data to RAM data and performs functional testing, if this option is selected (see subsection 3.5.5).

To verify and functionally test a device from Model 29 front panel control, perform the following steps:

NOTE

If options are desired (see subsection 3.5), select options and parameters as needed before proceeding.

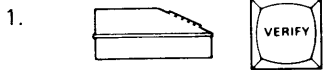

Model 29 Displays

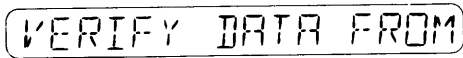

Model 29 Displays

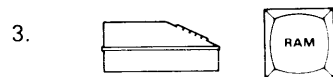
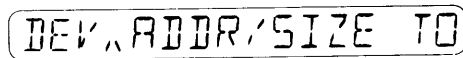

Model 29 Displays

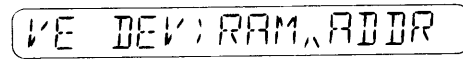

Model 29 Displays

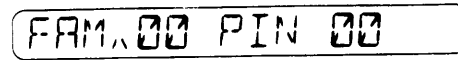

5. Enter the family code and pinout code if required (see subsection 3.4.1).
6. Insert the device to be verified and/or tested into the adapter socket (see subsection 3.4.2).



Model 29 Displays

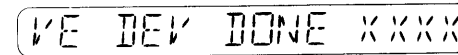
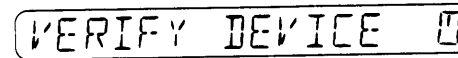

NOTE

XXXX is the sum-check of the device fuses.

8. Remove the master device from the adapter socket (see subsection 3.4.3).

Terminal Control

To verify and test a device from terminal control, follow the steps given below.

1. Place the system in the terminal mode; see subsection 3.5.1.
2. Enter the family code and pinout code, if prompted by the terminal.

.NOTE

If options are desired (see subsection 3.5), select options and parameters as needed before proceeding.

3. Insert device to be verified (see subsection 3.4.2).

4.



Terminal Displays

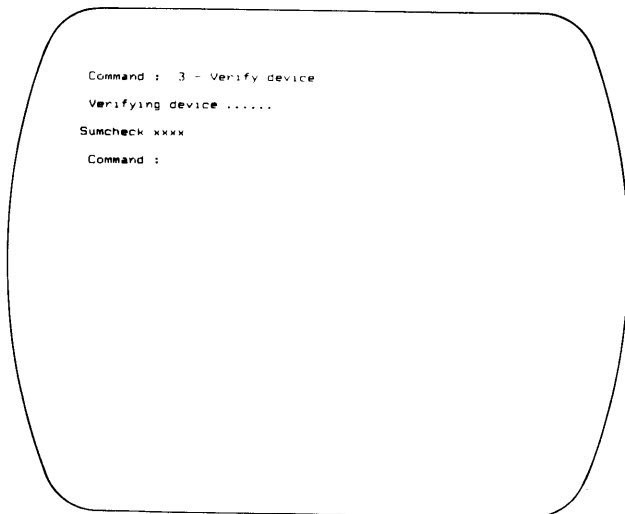

An action symbol will be displayed showing the verification function under way. Upon completion the terminal will display sum-check XXXX of the device fuses.

5. Remove device from socket (see subsection 3.4.3).

3.5 SYSTEM COMMANDS

In addition to the copy (load or program), verify, edit, and select functions described in the Operation section of your programmer manual, the LogicPak™ offers numerous system commands that allow you to manipulate data and set parameters. System commands are accessed by entering a two-character select code from the programmer front panel or a one-character menu code from the terminal. Some commands will prompt for data entry. The operational overview (figure 3-4) will help you develop data and program a device using the system commands and programmer operations. Table 3-1 lists the select codes for Data I/O programmers to enter system commands from the programmer front panel and the menu codes for control from a terminal in terminal mode.

.NOTE

The sequence explanations assume no operating errors. If these occur, the programmer signals with a beep and displays a two-digit error code in front panel mode or an error message in terminal mode. It also beeps once when an incorrect key is pressed. Error codes are explained in subsection 4.1 (table 4-2) and in your programmer manual. Some errors will return you to the programmer front panel control from the terminal mode.

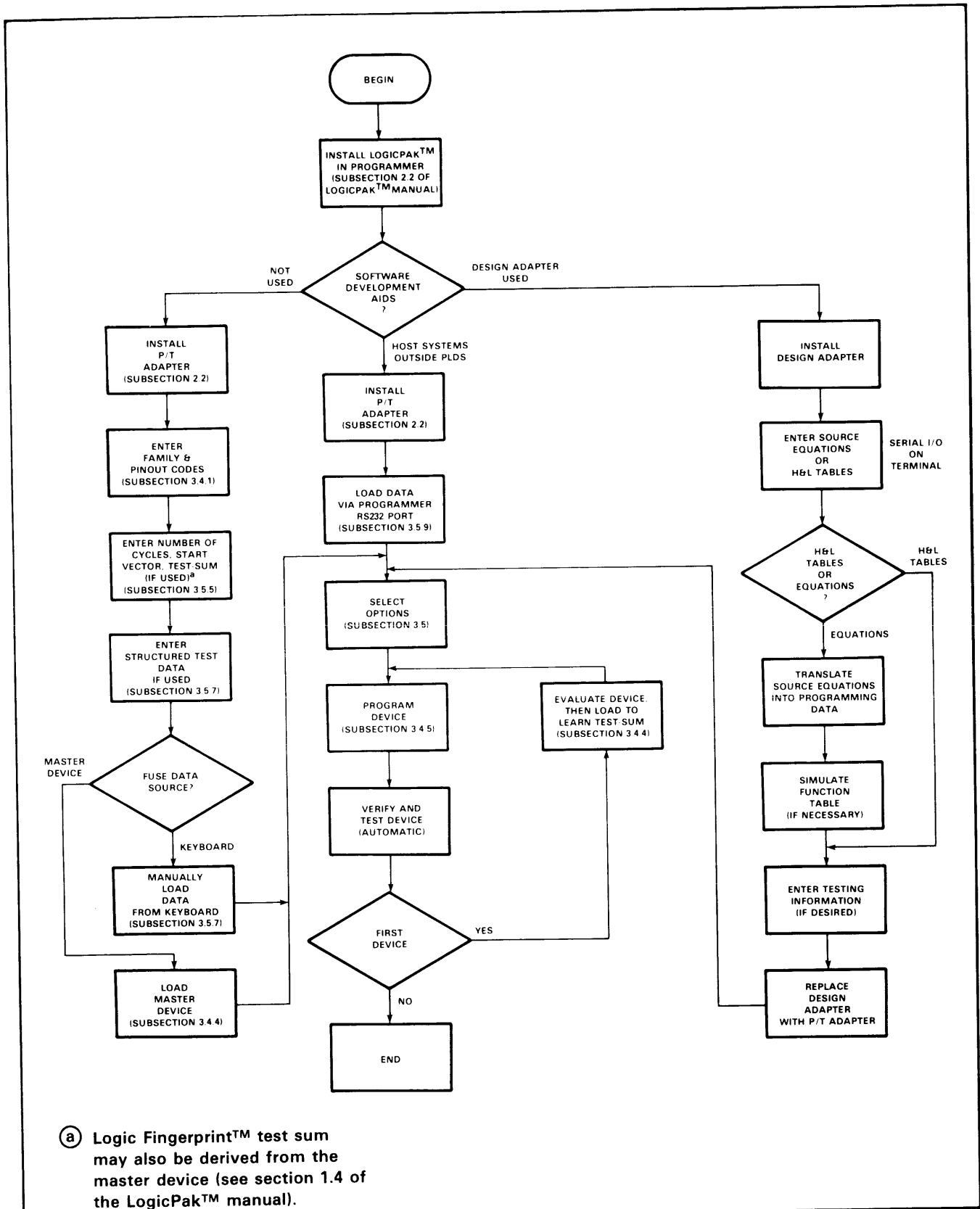
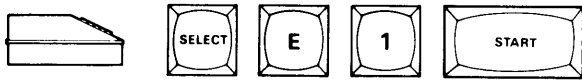

Figure 3-4. Operational Overview Flow Chart

3.5.1 ENABLE TERMINAL MODE



Select code *E1* transfers control of the PLDS to the terminal. After control is transferred, the Model 29 will display only its action symbol. This command allows you to access data development and remote operations resident in the design adapters and remote operations using the P/T adapters.

The terminal will prompt you to enter family codes and pinout codes unless they have already been entered. For P/T adapters only, see subsection 3.5.3. The terminal will then display the command menu (see figure 3-5).

See subsection 2.6 of the LogicPak™ manual for terminal setup procedure.

3.5.2 DISPLAY COMMAND MENU



This command causes the PLDS to redisplay its command menu on the terminal, as shown in figure 3-5.

3.5.3 FAMILY CODE AND PINOUT CODE

From the Model 29 front panel control, family code and pinout code entry is part of device-related operations (see subsections 3.4.1 through 3.4.5).



Terminal Displays

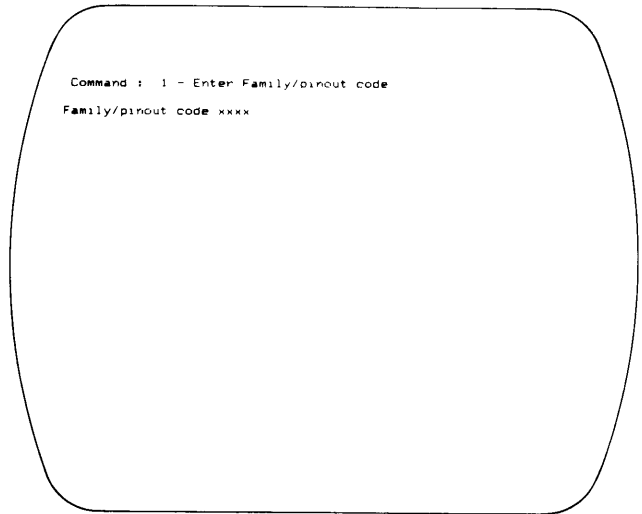

Enter the family code and pinout code (see subsection 3.4.1 for more detail). Space and backspace (*CTRL H*) may be used to move the cursor back and forth.

```

Command : 0 -- Display menu

DATA I/O CORP. - Programmable Logic Development System - 303A-V04
                Copyright 1982,1983,1984

    - GENERAL COMMANDS -
0 - Display menu
1 - Enter Family/pinout code
5 - Enter reject count option
6 - Enter verify option
7 - Enter security fuse option
8 - Enter functional test data
F - Configuration number
G - Select attributes

    - DEVICE RELATED COMMANDS --
2 - Load device
3 - Verify device
4 - Program device

    - I/O COMMANDS -
B - Receive JEDEC data
C - Transmit JEDEC data

    - FUSE MAP COMMANDS --
A - Display fuse pattern
D - Display fuse sumcheck
E - Edit fuse pattern

NOTE - Always transmit an "ESC" before removing adapter
    
```

Figure 3-5. PLDS Command Menu

3.5.4 SET REJECT COUNT OPTION

This command allows you to select the number of programming pulses applied to the device fuses before the programmer rejects the device as unprogrammable. The default value of 0 selects the manufacturer's specified number of programming pulses. Refer to the timing diagrams in section 4 for specific entries to select optional reject values for single-pulse, military specifications, etc.

NOTE

The PALASM adapter does not provide this option.

Front Panel Operation



Model 29 Displays

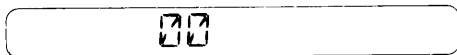

To change the reject count to an optional value, enter the code number (X) specified in the timing diagrams in section 4.

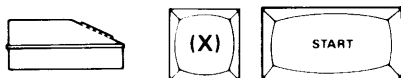

Model 29 Displays

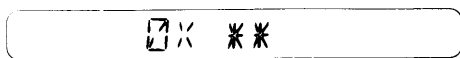

Terminal Operation

To select the reject count from the terminal, enter a 5 from the command mode, then respond to the prompt with the code number.



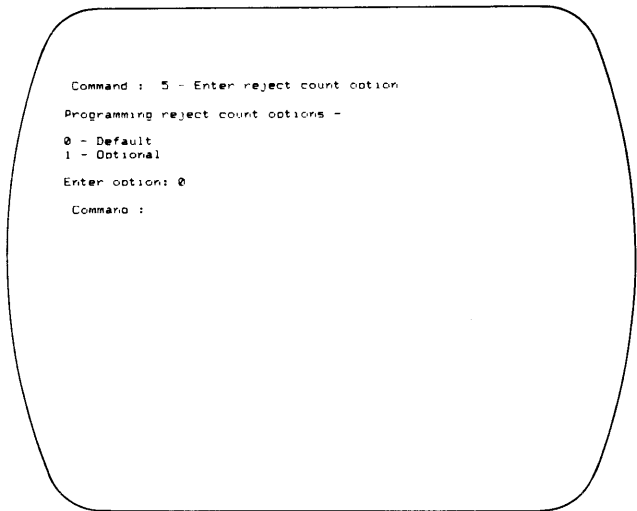

Terminal Displays



3.5.5 SELECT VERIFY OPTION

Three options are available for selecting verify and functional test routines. These routines are described in detail in subsection 3.4.6.

Options available are:

OPTIONS	DESCRIPTION
	Default option. Perform fuse verify, followed by structured test (if test vectors are present in RAM), and Logic Fingerprint™ test (if one or more Logic Fingerprint™ test cycles are selected), in that order.
	Perform fuse verify only.
	Perform structured test and Logic Fingerprint™ test only, in that order. Do not perform fuse verify.

Option 0 (default) is the option used in normal operation. Option 1 checks the programming of the device fuses without checking device functionality. Use option 2 to functionally test devices with the security fuse blown. In addition, option 2 can be used to learn the Logic Fingerprint™ test of a device with the security fuse blown. Fuse data in RAM will be cleared during this operation. Programming cannot occur with option 2 selected.

Verify options must be entered from either the programmer's keyboard or a terminal. The option will remain in effect until it is changed or until the unit is powered down. To reselect the default, key in option 0.

Front Panel Operation

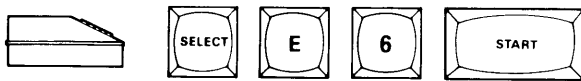

Model 29 Displays

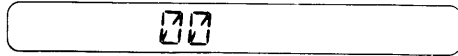

At this point, to select functional test, for example, do the steps which follow.

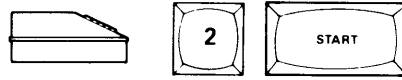

Model 29 Displays

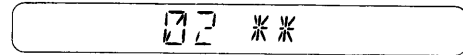

Terminal Operation

To enter the verify option from the terminal, enter 6 from the command mode, then respond to the prompt with the desired option. For example, to select functional test:

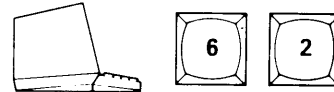

Terminal Displays

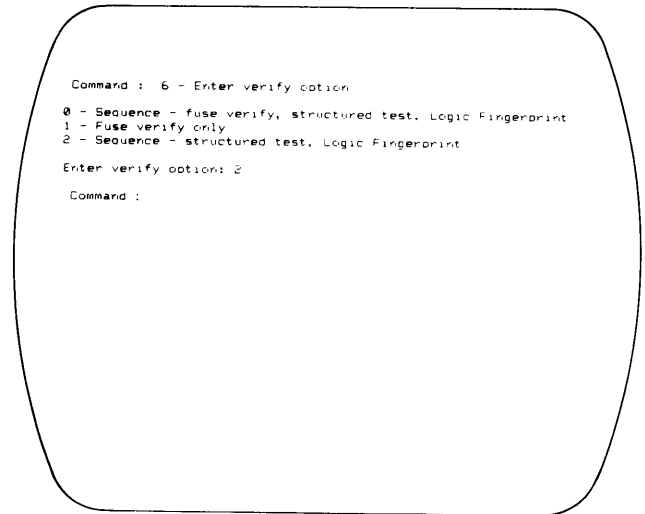

3.5.6 SELECT SECURITY FUSE OPTION

Some logic devices are equipped with protective fuses called security fuses. Once the security fuses are programmed, the fuse states in the logic array cannot be copied. Programming the security fuses makes it very difficult to pirate a device design.

The PLDS security fuse programming feature is a fail-safe function. You can either enable programming of the security fuse at all times, allow programming only when security fuse data are downloaded to the PLDS via the serial port, or disable programming completely, whether security fuse data are downloaded or not.

When the security fuse has been blown, a Logic Fingerprint™ test and structured test can still be performed, but a fuse verify operation is not possible (see subsection 3.5.5).

To enable programming of security fuses, two conditions must be met: 1) the security fuse state in the programmer RAM must be 1 (or true), and 2) security fuse programming must be enabled. Once the security fuse option is selected, it will remain in effect until changed or until the programmer is turned off.

When security fuse data are entered into RAM in the JEDEC ASCII-logic format, data in the **G** field indicate the state of the security fuse. The **G** field does not affect the enable state of the security fuse option; the enable state must be entered separately. This can be done before or after loading JEDEC ASCII-logic format data.

Security fuse states cannot be loaded from a master device.

CAUTION

Once the security fuse is blown, you no longer can verify the state of any fuse in the device. The process cannot be reversed; therefore, be certain that you want to program the security fuse before you activate this function. Attempting to reprogram the device after the security fuse is blown will alter the original fuse pattern and render the device inoperative.

Front Panel Operation

To select a security fuse option from the front panel:

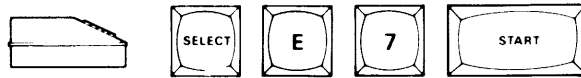

Model 29 Displays

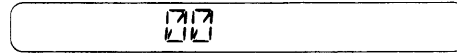

Security fuse select-code options are:

OPTION	DESCRIPTION
	Default option. Disable programming and set the security fuse state in RAM to 0 (unprogrammed).
	Disable programming, and set security fuse state in RAM to 1 (programmed). Enable programming, and set security fuse state in RAM to 0. (Data downloaded in the JEDEC format can change the security fuse state to 1.)
	Enable programming, and set security fuse state in RAM to 1. (Data downloaded in the JEDEC format can change the security fuse bit back to 0.)

For example, to enable security fuse programming and set security fuse state in RAM to 1 (option 3):

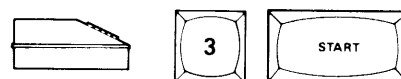

Model 29 Displays

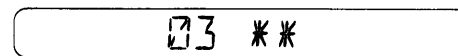

Terminal Operation

To enter the security fuse option from the terminal, enter 7 from the command mode, then respond to the prompt with the desired option. For example, to enable security fuse programming and set security fuse state in RAM to 1, do the following:

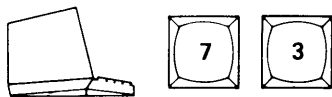

Terminal Displays

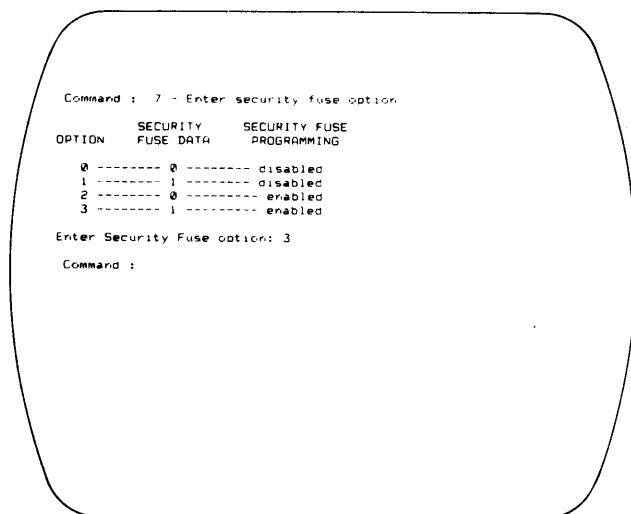

3.5.7 ENTER FUNCTIONAL TEST DATA

Functional test data includes information for the Logic Fingerprint™ test and also the test vectors used by P/T adapters for testing of a programmed device. The Logic Fingerprint™ test information consists of three components:

- The number of test cycles to be performed during the Logic Fingerprint™ test (described later in this subsection). The default value is 00, which disables the Logic Fingerprint™ test.
- The Logic Fingerprint™ starting vector. This is an arbitrary binary sequence, each bit of which corresponds to a pin on the device under test. The starting vector format for a 20-pin device is shown below. Each "x" represents a "1" or a "0" to apply a logic high or logic low to the corresponding pin. Values entered for V_{CC} and ground affect the resulting Logic Fingerprint™ test signature, but have no effect on the device under test.

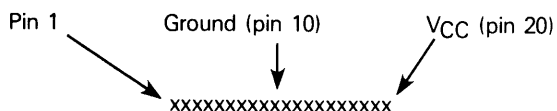

The starting vector is used to initialize the Logic Fingerprint™, and is one of the components (along with the device type, number of test cycles, and programming pattern) which determine the resulting Logic Fingerprint™ test signature. Note that different Logic Fingerprint™ test signatures may result for a given logic design, depending on the choice of starting vector.

- The Logic Fingerprint™ test signature itself is the result of performing the Logic Fingerprint™ test, as described later in this subsection.

Logic Fingerprint™ test data may be entered from either the front panel or the terminal. From the front panel, the number of test cycles and the starting vector for the Logic Fingerprint™ test may be entered, and the resulting Logic Fingerprint™ test signature may be viewed or entered. Structured test vectors may not be entered or edited from the front panel but only from a terminal or serial download. All functional test data may be entered from the terminal, including number of test cycles, starting vector, the Logic Fingerprint™ test signature itself, and the test vectors.

NOTE

If a value is entered for the Logic Fingerprint™ test signature, it should be either 00000000 or a known-good value corresponding to the number of test cycles, starting vector, device, and fuse patterns under test. A value of 00000000 will cause the LogicPak™ to "learn" the correct Logic Fingerprint™ test signature when a Load, Program, or Verify operation is performed (see subsection 3.4 for details). When in Load, the correct Logic Fingerprint™ will be learned independently of the value entered.

If "Device Selection Error" (Error 30) appears when you select functional test data, you must specify family code and pinout code to define the vector width.

In the subsections which follow, functional test data will be entered to test the Basic Gates design example^a (see figure 3-9).

Front Panel Operation

From the front panel, the number of test cycles and the Logic Fingerprint™ starting vector may be entered, and the Logic Fingerprint™ test signature may be viewed or entered.

Set Number of Logic Fingerprint™ Test Cycles.

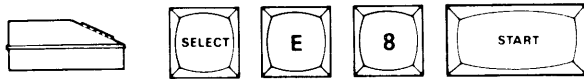

Model 29 Displays

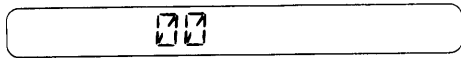

For example, to enable one cycle of testing,

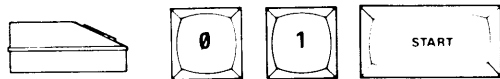

Model 29 Displays

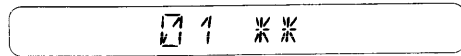

Logic Fingerprint™ and Starting Vector

The starting vector must be converted from the binary form to hexadecimal for entry from the front panel. For our Basic Gates example, we will choose an arbitrary test vector as shown:

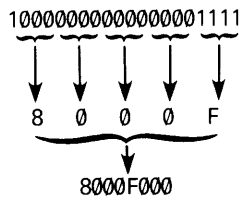

Starting vector
(binary)

(hexadecimal)

Starting vector
(hexadecimal)

The unused portion of the 32-bit vector is assumed to be zeroes and must be included in the hexadecimal vector entry.

For example:

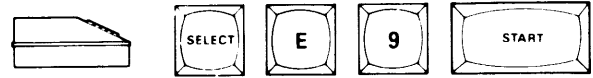

Model 29 Displays

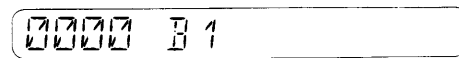

NOTE

The eight-character starting vector is entered into the programmer in two fields. B1 identifies the first field.

To enter the first four hexadecimal digits,

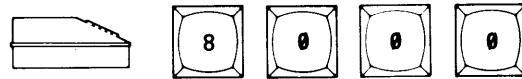

Model 29 Displays

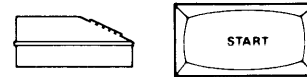
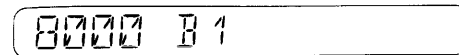

Model 29 Displays

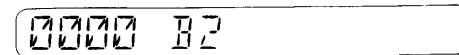

NOTE

B2 represents the second field.

^aAdapted from THE MMI PAL HANDBOOK, available from Monolithic Memories, Inc., 1165 Arques Avenue, Sunnyvale, California 94086.

Enter the remaining hexadecimal digit by pressing

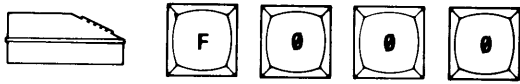

Model 29 Displays

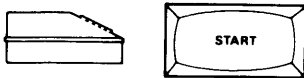
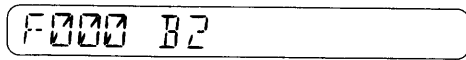



The zeroes are ignored, but are needed to correctly position the "F."

This vector, when applied to the Basic Gates example, produces the Logic Fingerprint™ test signature:

ED37A9E4 (hexadecimal)

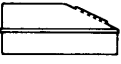
This value may be viewed or entered at this time by pressing *START*:

1.   Enter the first four characters of the Logic Fingerprint™ test signature if desired.

Model 29 Displays

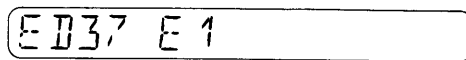

The first four characters are displayed as the *E1* field. The last four characters (*E2* field) may be viewed or entered by pressing *START* again:

2.   Enter the next four characters if desired.

Model 29 Displays

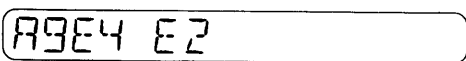

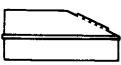
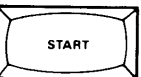
3.  

Model 29 Displays

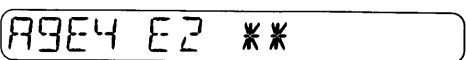

Terminal Operation

Entering an "8" from the Command mode allows you to enter functional test data and begin vector editing from the terminal.



The functional test data may be entered in response to three prompts (see figure 3-6).

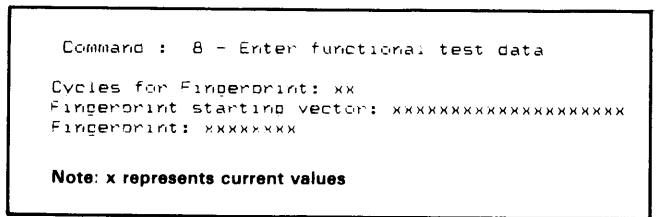

Figure 3-6. Prompts for Entering Functional Test Data

As each prompt appears, you may modify the current values (represented by x's in figure 3-6) using the following steps:

1. Move the cursor forward (using the spacebar) and backward (using the backspace) along the displayed value until it is positioned over the symbol to be changed.
2. Press the desired symbol.
3. Enter *RETURN* at any point to move to the next prompt.
4. *CTRL Z* is used to exit the functional test entry mode.

For our test example, the values shown in figure 3-7 should be entered.

Vector Editing

Vectors are created by downloading JEDEC 'V' fields, simulating a source file containing a function table, or by using the vector editor.

When the Logic Fingerprint™ test information has been entered (or skipped by entering *RETURN*), the vector editor menu appears (see figure 3-7), and a prompt appears for the vector number to be edited. The default vector is 0001, as shown in figure 3-7.

The vector editor is a fixed-format line editor with the first column of the displayed line reserved for command characters, as shown below.

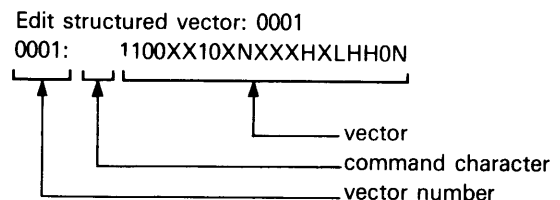

```

Command : B - Enter functional test data
Cycles for Fingerprint: 01
Fingerprint starting vector: 100000000000000000001111
Fingerprint: ED37A9E4

      - DISPLAY -
0 ----- Display menu
Return ----- Go to next vector
U ----- Up (previous vector)
#(N) ----- Go to vector (N)
Space ----- Move cursor right
BKSP (CTRL H) - Move cursor left
CTRL Z ----- Exit vector editor

      - EDITING COMMANDS -
D ----- Delete (Kill) current vector
R ----- Repeat current vector
CTRL Z -- Exit vector editor

Edit structured vector: 0000
0001: 1100XX10XNXXXHXLHH0N
0002: -----

```

Figure 3-7. Entering Functional Test Data

A character entered in the first column (normally blank) is interpreted as a command and acted upon immediately; otherwise, vector editing is not processed until a *RETURN* is entered (at any point on the line). The command characters recognized in the first column are 0, U, #, D, and R; see table 3-2 for command character definitions.

During operation, the vector editor copies the selected vector to a temporary buffer where all editing changes are made. Then, when a *RETURN* command is entered, the temporary buffer is examined for legal characters before

copying back to vector memory. You are not allowed to proceed to another vector until all characters are legal in the current vector. Typing a *CTRL Z* to exit the vector editor will leave the selected vector in its original state.

An "empty vector" is represented by a dash in all pin positions. This will appear as the first vector in an empty vector editor buffer, or as one past the last vector where data are present in memory. All vectors are numbered lower than the empty vector.

Table 3-2. Vector Editor Command Characters

COMMAND	DESCRIPTION	ACTIVITY
0 (zero)	Display menu	Redisplays menu and restarts editing on the same vector.
U	Up (previous vector)	Moves editing to the next lower vector number (the vector one 'up' on the screen).
#(N)	Go to vector (N)	Entering a '#' in the command column causes the vector editor to prompt for the desired vector number (default = 0001). Entering a vector number greater than the last vector will move you to the last vector.
D	Delete current vector	Current vector is deleted, and all higher vectors moved down one. Current vector number is redisplayed with new vector.
R	Repeat current vector	Creates a copy of the current vector immediately following the current vector. The copy is displayed, with its vector number (one greater than the original). This command may be given for any vector, and existing vectors will be moved to accommodate the new copy.

To edit a vector, follow the steps below.

1. Move the cursor forward (using the spacebar) and backward (using the backspace) along the displayed vector until it is positioned over the test condition to be changed.
2. Type the desired test condition to enter it into the vector image; the allowable test conditions are 0-9, X, N, F, H, L, Z, C, P, and K (see table 3-3 for test condition definition).

Table 3-3. Vector Symbol Definition

VECTOR SYMBOL	DEFINITION
0	Drive input low
1	Drive input high
2-9	Drive input to supervoltage #2-9
C	Drive input low, high, low
K	Drive input high, low, high
N	Power pins and outputs not tested
L	Test output low
H	Test output high
Z	Test output for high impedance
F	Float input or output
X	Ignore input or output (not defined in JEDEC format)
P	Preload (applied to clock pin)

NOTE

"X" is not defined in the JEDEC format. The "X" is treated as an "N" for outputs and leaves an input at its previously defined state.

Test conditions 2 through 9 specify non-TTL levels (supervoltages) that access special device features. A device may be damaged by improper use of supervoltages.

3. Enter *RETURN* or *CTRL Z* at any point to move to the next vector or to exit the vector editor.

Register Preload

In some registered logic devices, the internal registers can be arbitrarily loaded to a desired state. This capability allows easier functional testing by providing a means of achieving states which may be difficult or impossible to enter by normal state transitions.

For devices which have the register preload feature (see table 3-4) preload is accomplished by using a "preload vector," a structured vector which has a "P" symbol in the clock pin position. Also in the preload vector are special symbols in the positions of the pins associated with loading of the registers. The symbols used in the preload vector and their functions are described in table 3-5.

Table 3-4. Preloadable Devices

AmPAL16R8	(family/pinout code 9782 only)
AmPAL16R6	(family/pinout code 9780 only)
AmPAL16R4	(family/pinout code 9781 only)
AmPAL22V10	("H" and "L" preload symbols not valid)

Table 3-5. Preload Vector Symbols

P	Identifies preload vector and invokes preload algorithm. (Allowed on clock pin only, otherwise treated as "X".)
0	Preloads a logic "0" into the register \bar{Q} output, meaning a logic "1" will be loaded into the register Q output. Does not test device outputs.
1	Preloads a logic "1" into the register \bar{Q} output, meaning a logic "0" will be loaded into the register Q output. Does not test device outputs.
L	Preloads register with the appropriate level such that a logic "0" appears on the device output pin. Also tests the preloaded device output and indicates an error if a logic "0" is not found. Not allowed for some devices (see note below).
H	Preloads register with the appropriate level such that a logic "1" appears on the device output pin. Also tests the preloaded device output and indicates an error if a logic "1" is not found. Not allowed for some devices (see note below).

All pins not used in the device's preload algorithm (regardless of the symbol placed in the preload vector pin position) are treated as "X"s (left in their previous state). Pins which are used in the preload algorithm may not return to their original state following preload. For example, to preload a 20-pin device with preload pins (most likely device outputs) 12 through 19, you might apply the following preload vector (clock pin assumed to be pin 1):

0001: PXXXXXXXXNXHLHLHLHLN

When the preload vector is applied during functional testing, the device-specific preload algorithm is invoked and the registers are loaded with the appropriate data to make the outputs high ("H") or low ("L"). The output pins are then tested to verify that the preload was successful.

Assuming the device has an inverter between the register output and the output pin, another method of achieving the same results as above is to use the following two vectors:

```
0001: PXXXXXXXXNX10101010N
0002: XXXXXXXXXXXNHLHLHLHLN
```

The first vector is a preload vector using "1"s and "0"s to load the \bar{Q} output of the register with the data indicated (thus making the Q outputs of the registers the complements of the data in the vector). Since we have assumed an inverter between the Q output and the output pin, the data found on the output pins after execution of the preload vector should reflect the "1"s and "0"s in the preload vector. The second vector shown is a conventional structured vector which tests the outputs for the desired data.

The "1" and "0" preload symbols are most useful for preloading registers whose state cannot be read at a device pin, or for any case in which the user is concerned with setting up the state of the REGISTERS and not necessarily the state of the output pins.

The "H" and "L" preload symbols are used to preload the states of OUTPUT PINS whose states are determined by the data in internal registers. The programming/testing adapter firmware determines what data should be placed in the internal registers to provide the correct outputs. Users concerned with preloading the state of the internal registers can use the "H/L" preload vector to load and automatically verify internal register states provided that data inversion (if any) between registers and outputs is considered.

NOTE

The "H" and "L" preload vector symbols cannot be used to preload devices with registers whose state cannot be read from a device pin (see table 3-4). An attempt to use an "H" or "L" preload symbol on such a device will cause an error message to be generated, and preloading of the device pin will not be attempted. A "1" or "0" preload symbol can always be used to preload the state of preloadable registers.

3.5.8 DISPLAY FUSE PATTERN

This command transmits the fuse pattern in the programmer data RAM to the serial port. The fuse states may be shown as a series of "1"s and "0"s or a series of "-"s and "X"s; see subsection 3.5.12 on selecting characters. The "1" or "-" represents a high-resistance fuse, "blown" in a fuse link device. The "0" or "X" represents a low-resistance or "intact" fuse. Each fuse can be identified by a decimal fuse number, as shown in figure 3-8. The fuse states are arranged in a matrix that corresponds to the logic diagram

of the device (figure 3-9). This is useful for comparing or copying a displayed fuse pattern to the device logic diagram. Logic diagrams and fuse number charts for all supported devices are in appendix A.

NOTE

Sending certain control characters to the PLDS during the course of fuse pattern display will affect the display. The output may be stopped by sending a CONTROL S (DC1 or ASCII, 11 hex) and then restarted by sending a CONTROL Q (DC3 or ASCII 13 hex).

A CONTROL Y (ASCII, 19 hex) will terminate the transmission and return to the terminal or front panel operation.

An ESC (escape) character (ASCII 1B hex) will terminate the transmission and return to front panel operation.

The last character of the fuse pattern transmission is either CONTROL C (ETX or ASCII 03) or a CONTROL Z (ASCII 1A hex). (See subsection 3.5.12 on selecting the termination character.)

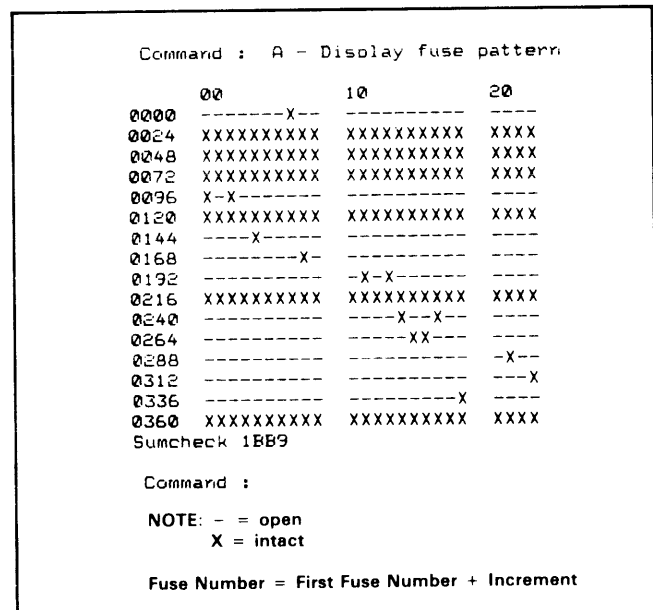

Figure 3-8. Complete Fuse Pattern

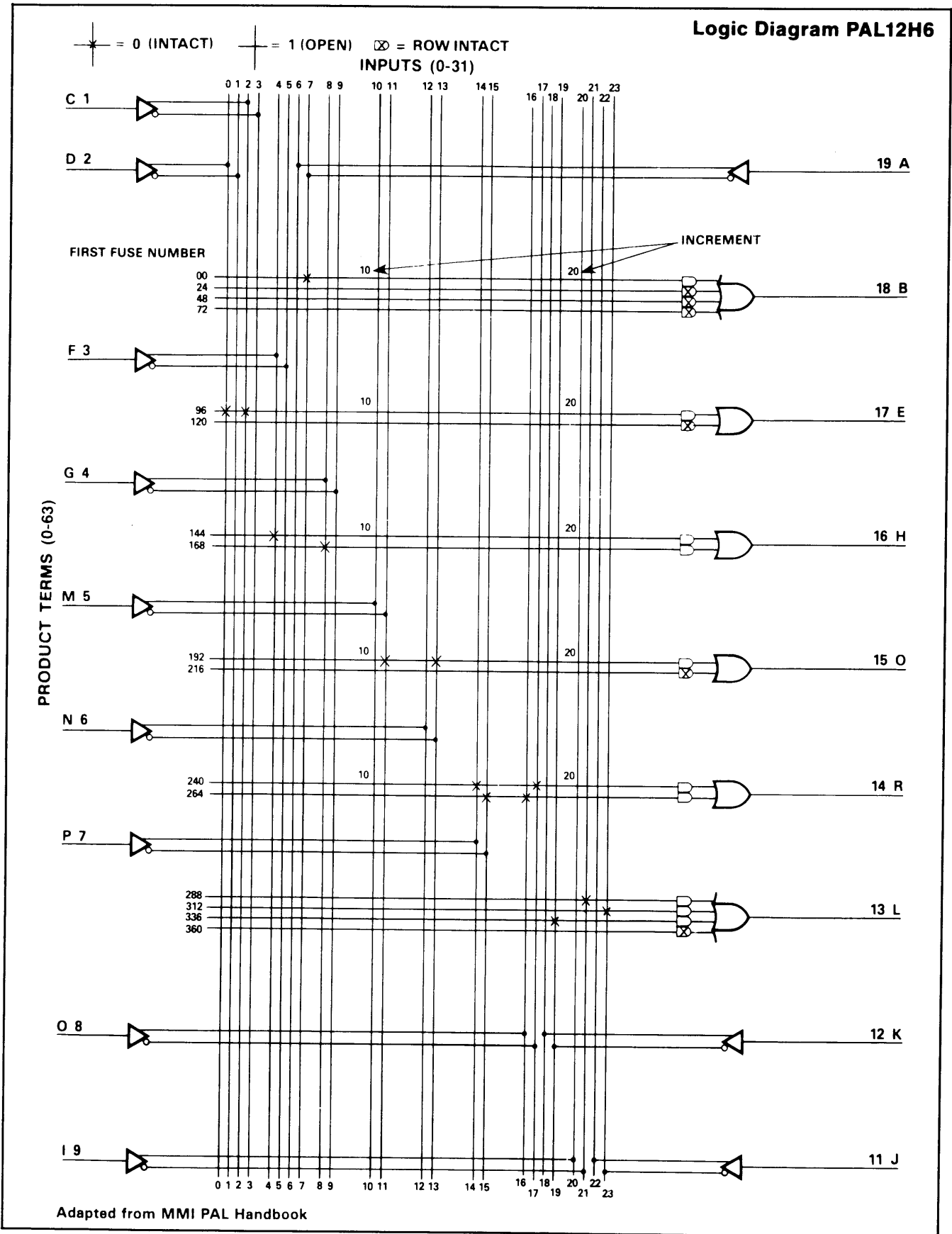
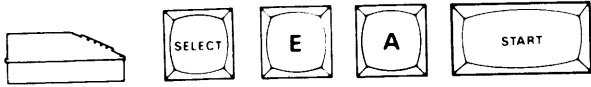

Figure 3-9. Logic Diagram for Basic Gates Example

Front Panel Control

To display the fuse pattern from front panel control, follow these steps:



Model 29 Displays



Model 29 Displays

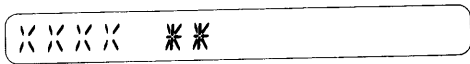

NOTE

is the action symbol. XXXX is the fuse array checksum.

Terminal Control

To display the fuse pattern from the terminal command mode, enter an A:



Terminal Displays

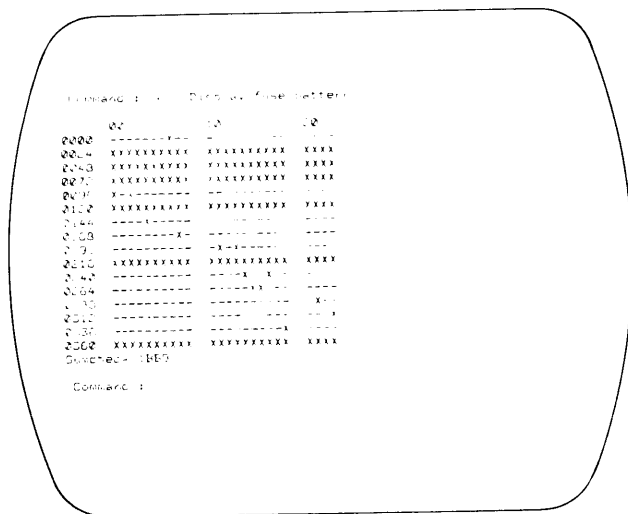

3.5.9 JEDEC FORMAT DATA EXCHANGE

Fuse data, test vectors, and the Logic Fingerprint™ test signature are transmitted between the host computer and the PLDS in the JEDEC format. The JEDEC format is described in detail in appendix A of the LogicPak™ manual. A brief overview of the format is provided in this section, and shown in figures 3-10 and 3-11. Figure 3-10 shows an example JEDEC transmission and its components.

The transmission consists of a start-of-text *STX* character, the various fields, an end-of-text *ETX* character, and a transmission checksum, as shown in figure 3-11.

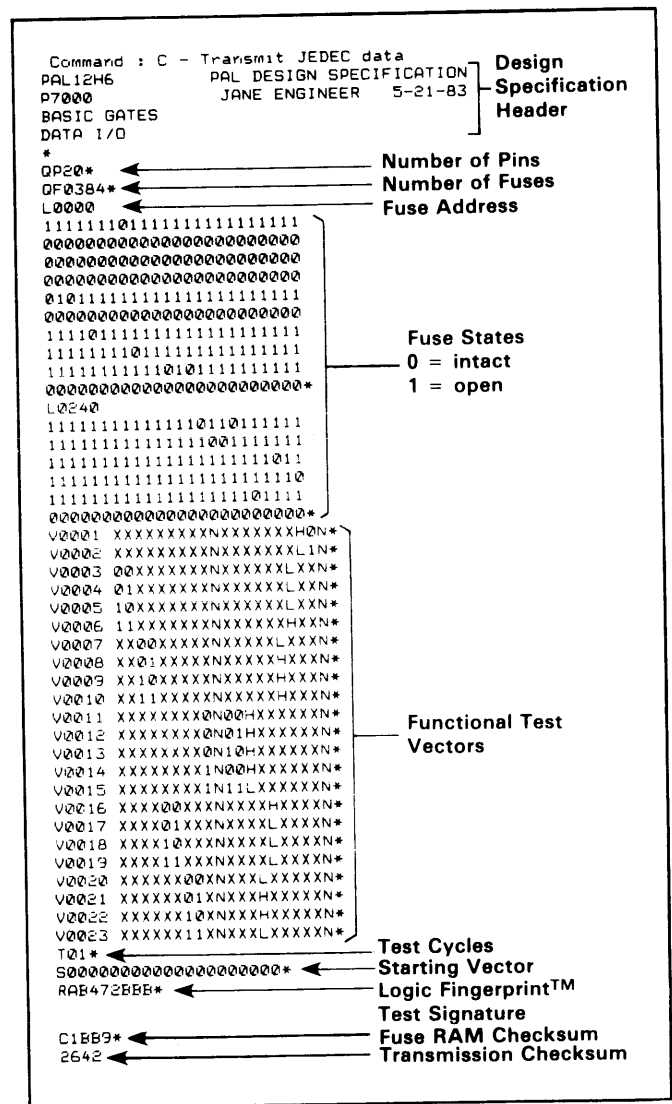

Figure 3-10. JEDEC Transmission—Basic Gates Example

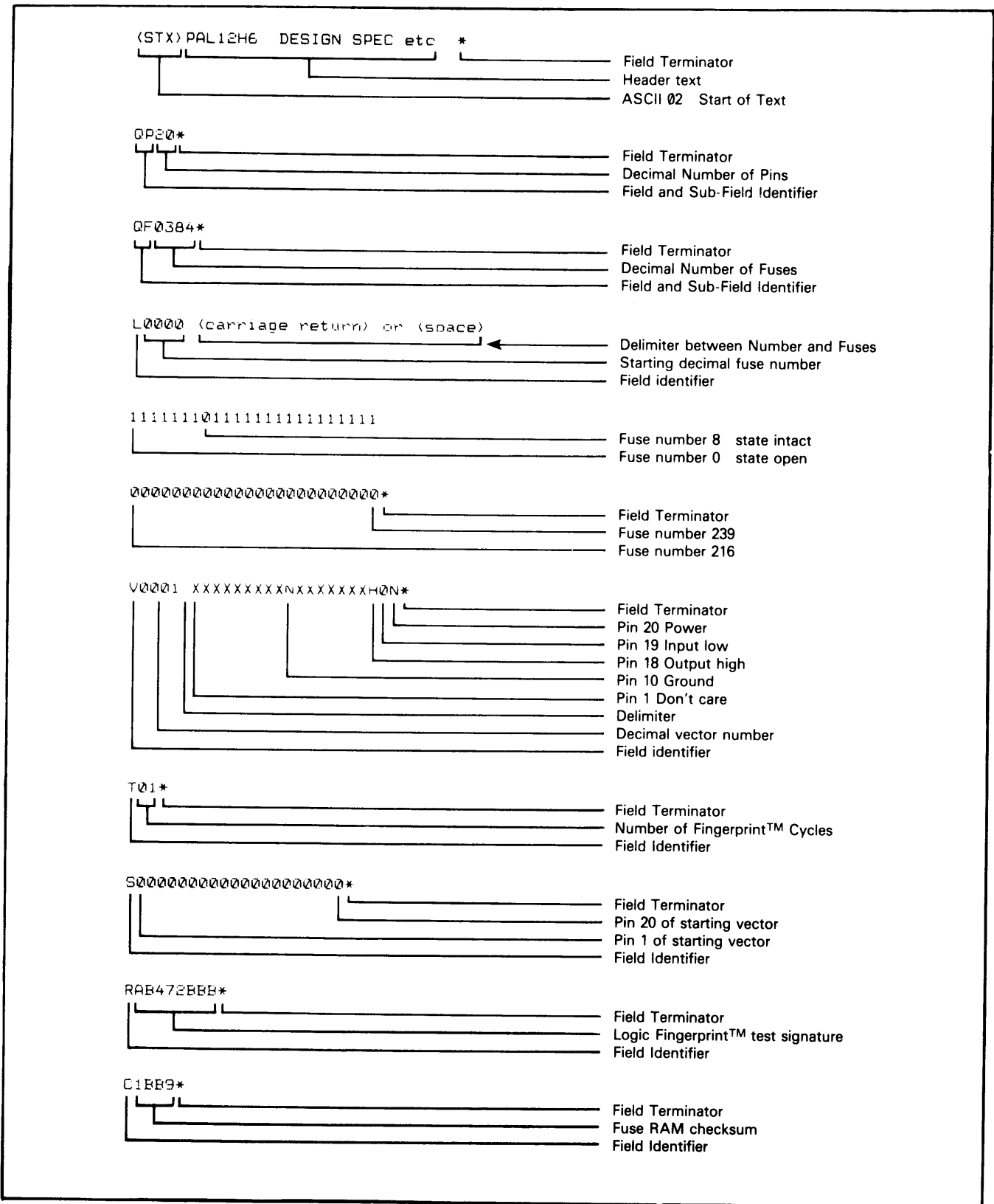

Figure 3-11. JEDEC Format (Breakdown of Figure 3-10)

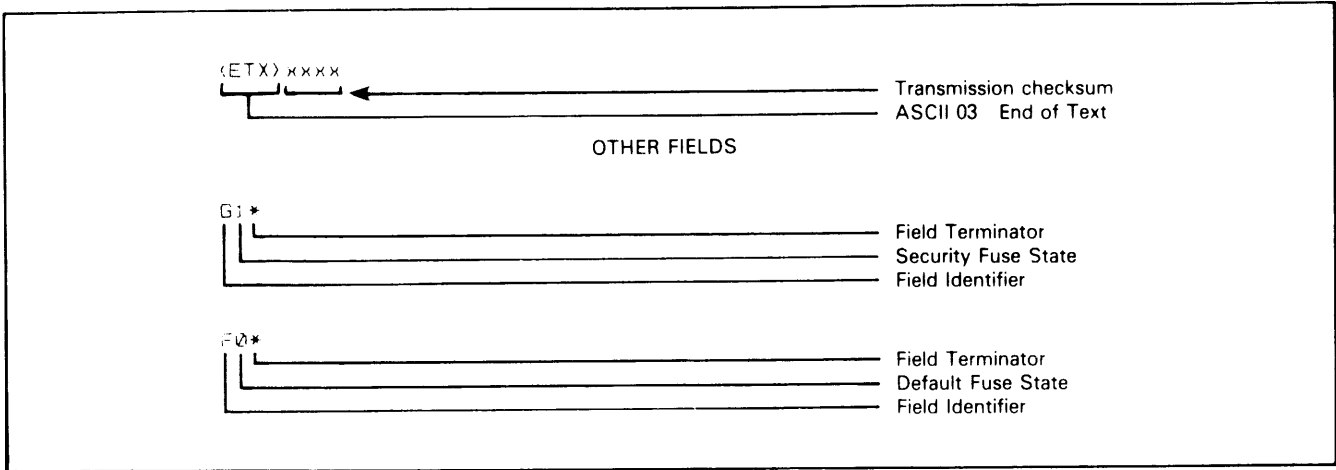

Figure 3-11. JEDEC Format (Breakdown of Figure 3-10) (Cont.)

The transmission checksum is the 16-bit sum of all ASCII characters transmitted between and including the *STX* and *ETX*. The parity bit is excluded in the calculation (see figure 3-12). The transmission checksum computed by the PLDS may be found by examining data RAM addresses 405 and 406, using the programmer's *EDIT* mode (discussed later in this subsection). Some computer operating systems do not allow a user to control what characters are sent, especially at the end of a line. The transmission checksum may be disabled in this case by sending a dummy checksum of 0000.

In general, each field in the format starts with an identifier, is followed by the information, and is terminated with an asterisk. For example, "T01*" sets the number of Logic Fingerprint™ test cycles to 1. The design specification header does not have an identifier and must be the first field in the transmission, immediately following the *STX*.

Fuse information is specified by the "QF", "F", "L", and "C" fields. The "QF", "F", and "C" fields are optional.

The "QF" field sets the maximum allowable number of fuses. The "F" field sets the default fuse value. An "F0*" fills the fuse RAM with 0s, and an "F1*" fills the fuse RAM with 1s. This operation takes a significant amount of time and can lead to an input buffer overflow at high baud rates.

The "L" field starts with a decimal fuse number and is followed by a stream of fuse states (1 or 0). The fuse number may include leading zeroes (i.e., "L12" and "L0012" are the same). A "space" and/or a "carriage return" must separate the fuse number from the fuse states. The stream of fuse states can be as long as desired (up to the maximum allowable fuse number). The fuse data for an entire device, for example, could be sent in one "L" field starting at zero and continuing for all fuses in the device. Spaces and carriage returns may be inserted to make the stream more readable. Each "L" field must be terminated with an asterisk.

The "C" field is the sum-check of the entire fuse RAM (fuse number 0 to maximum fuse number for the selected device), not just the fuse states sent. See figure 3-13. (The JEDEC term "Fuse Checksum" is the same as Data I/O's term "sum-check.")

The "C" field is the sum-check of the entire fuse RAM (fuse number 0 to maximum fuse number for the selected device), not just the fuse states sent. See figure 3-13. (The JEDEC term "Fuse Checksum" is the same as Data I/O's term "sum-check.")

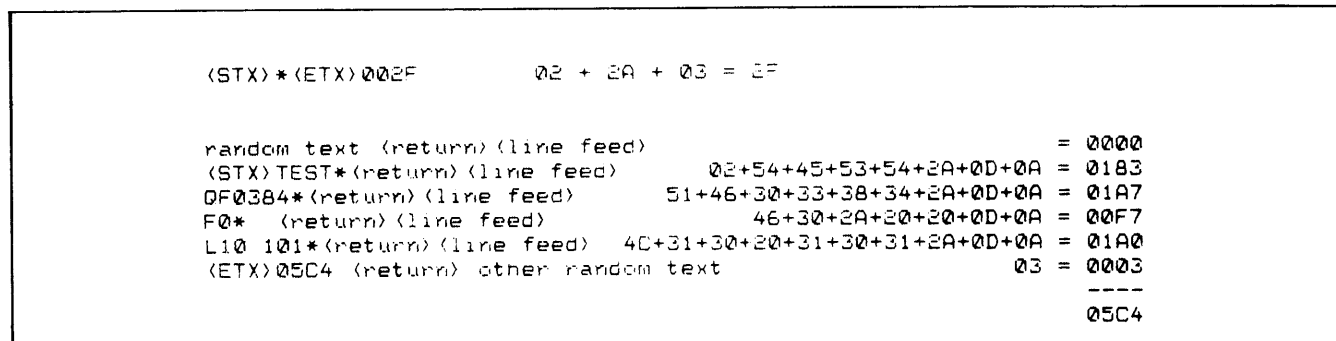

Figure 3-12. Computing the Transmission Checksum

The structured test vector information is specified by the "QP", "P", and "V" fields. The "QP" field defines the number of pins on the device. The "V" field starts with a vector number, is followed by a space, then by a series of test conditions for each pin, then is terminated with an asterisk. The test conditions are normally sent in pin number order; however, the "P" field can specify a different sequence. The PLDS JEDEC translator does not validate the test conditions in the vectors (see table 3-3 for the presently defined test conditions). The supervoltage test conditions (2 through 9) are used to apply non-TTL levels to certain pins to access special test features. A device could be damaged by improper use of supervoltages.

The Logic Fingerprint™ test information is specified by the "T", "S", and "R" fields. The "T" field defines the number of test cycles to be performed. The legal values are 0 to 99. The "S" field defines the starting vector with a series of 1s and 0s for each pin. The "R" field defines the 8-digit hexadecimal Logic Fingerprint™ test signature.

The "G" field defines the security fuse state.

The "D" field is not sent by new versions of the PLDS JEDEC translator. It has been replaced by the "QF" and "QP" fields and the manual setting of family codes and pinout codes.

Transmit JEDEC Data

This command transmits the contents of the fuse and vector RAM to the serial port in the JEDEC format (see appendix A of the LogicPak™ manual).

The following characteristics apply to JEDEC transmission:

- The output may be halted by sending a *CONTROL S* (DC1 ASCII, 11 hex) and restarted by sending a *CONTROL Q* (DC3 or ASCII, 13 hex).
- An *ESC* character (ASCII, 1B hex) will abort the transmission and return to the programmer front panel operation.
- A *CONTROL Y* (ASCII, 19 hex) will terminate the transmission and return to the terminal or programmer front panel operation.
- The Logic Fingerprint™ test fields (S, R, and T) are not sent if the number of cycles is 0.
- The "G" field is sent only if security fuse data is a "1."
- The fuse checksum (C field) is the 16-bit sum of all fuse states (i.e., from fuse 0 to the fuse limit for the device). See figure 3-13.

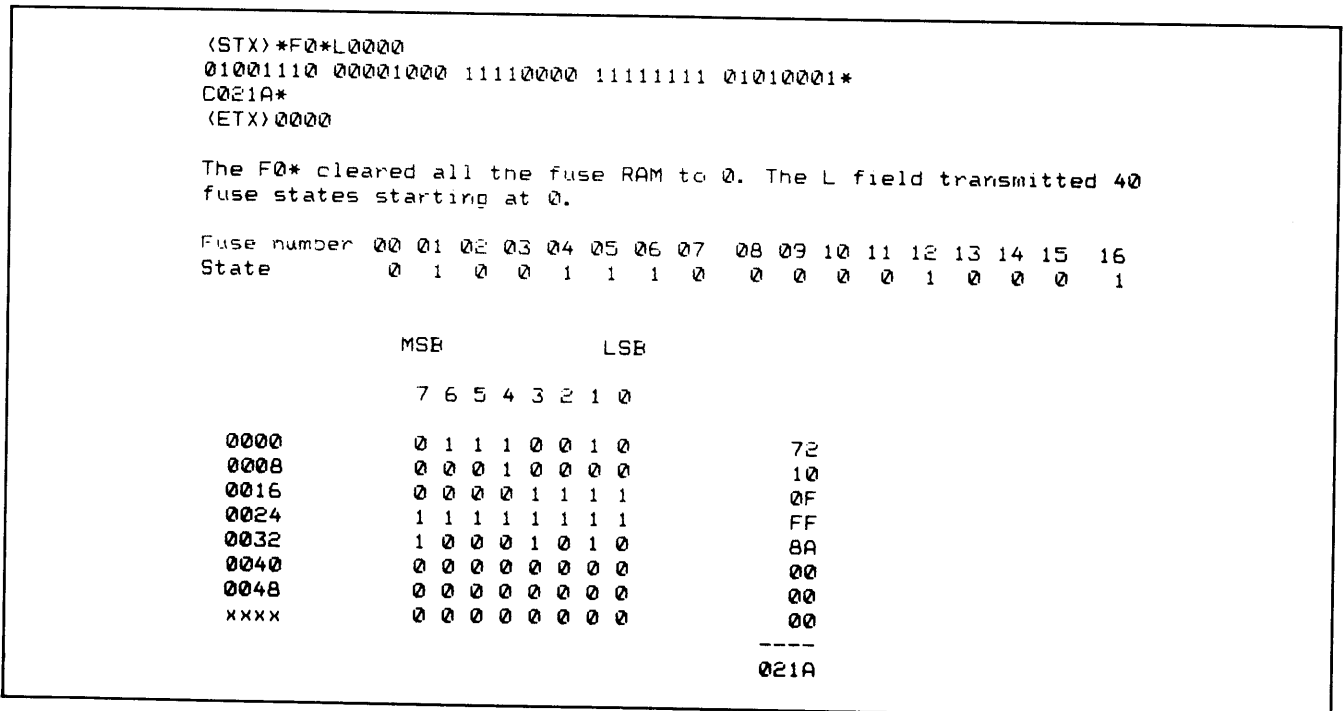
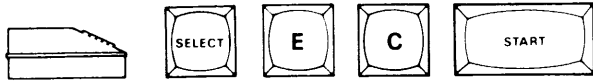

Figure 3-13. Computing the Fuse RAM Checksum

Front Panel Control

To transmit JEDEC data, follow the steps below.



Model 29 Displays

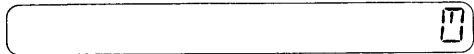

Model 29 Displays

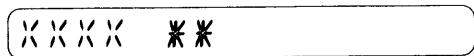

NOTE

 is the action symbol. XXXX is the fuse array checksum.

Terminal Control

To transmit JEDEC data from the terminal mode, enter a "C" from the Command mode:



See figure 3-10 for the terminal display of the Basic Gates design example data.

Receive JEDEC Data

This command prepares the programmer to receive fuse and vector data from a peripheral device via the serial port. A translator converts the JEDEC format data (see appendix A of the LogicPak™ manual) to the memory image required by the PLDS.

NOTE

The D field is ignored by the translator.
The correct family code and pinout code must be entered before receiving JEDEC data. See table A-1 in appendix A for correct family codes and pinout codes.

Three types of errors may be caused by receiving improper data in the JEDEC format (see table 3-6).

Table 3-6. Translator Input Errors

ERROR	DESCRIPTION	POSSIBLE FIELDS
82	SUMCHK ERR	Transmission check-sum
84	INVALID DATA	ETX F L S V
91	I/O FORM ERR	C G L P R T V

You may determine the field in which the error occurred by examining data RAM location 0408; the ASCII value (hexadecimal) of the field is stored here (see table 3-7). More information about the possible cause of the error may be found in table 3-8.

Table 3-7. ASCII Values of Field Identifiers

FIELD IDENTIFIER	ASCII CHARACTER HEX VALUE
(ETX)	03
C	43
F	46
G	47
L	4C
P	50
R	52
S	53
T	54
V	56

To examine the data RAM location 0408, perform these steps.



Model 29 Displays

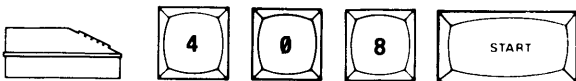
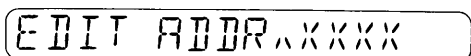

Model 29 Displays

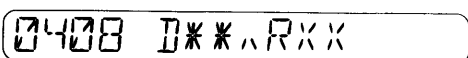

NOTE

XXXX is the current address. XX is the field identifier in hexadecimal.

The transmission checksum computed by the PLDS may be found by examining data RAM locations 405 and 406 in a similar manner.

Front Panel Control

To receive JEDEC data from the front panel mode perform the steps which follow.

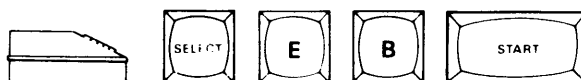

Model 29 Displays



Model 29 Displays



NOTE

 is the action symbol. XXXX is the fuse array sum-check.

Table 3-8. Translator Input Error Codes

ERROR	DISPLAY	FIELD*	POSSIBLE CAUSE
82	SUMCHK ERR	ETX	Transmission checksum of all ASCII characters does not match the computed value.
84	INVALID DATA	ETX	Fuse sum-check does not match computed sum-check. The comparison is not made until the transmission is complete, so the field is stored as ETX rather than C. The sum-check includes the entire fuse RAM as defined by the family and pinout code, not just the fuse states sent.
91	I/O FORM ERROR	F	Invalid character in field. Only "1" and "0" are allowed.
		L	A space or carriage return did not follow the fuse number.
		L	An invalid character was in the fuse state field. Only "1" and "0" are allowed. Spaces, line feeds, and carriage returns are ignored.
		S	Invalid character in field. Only "1", "0", and "N" are allowed.
		V	Too few or too many test conditions.
		C	Invalid character in field, must be 4 digit hexadecimal number.
		G	Invalid character in field. Only "1" or "0" are allowed.
		L	Fuse number exceeds fuse limit for device or invalid fuse number (must be decimal number).
		P	Too few or too many pins or invalid pin number for device.
		T	Test cycles greater than 99.
		R	Invalid character in field: must be 8-digit hexadecimal number.

*From RAM Addr. 0408

Terminal Control

To receive JEDEC data from the terminal mode, enter a "B" from the Command mode:

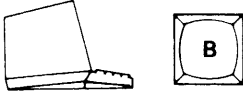

Terminal Displays

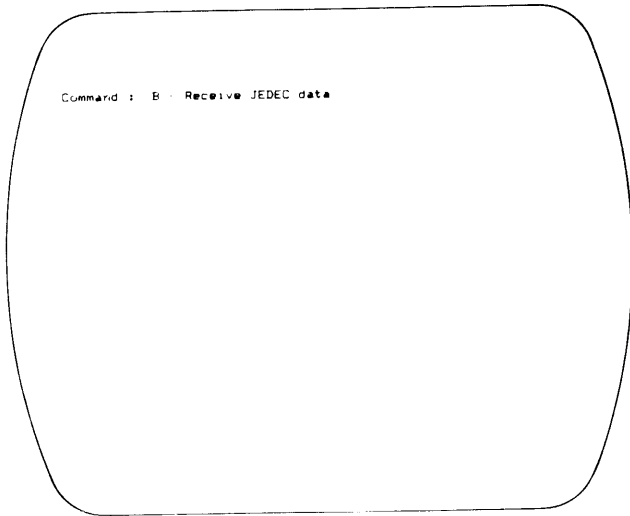

3.5.10 EDIT FUSE PATTERN

The individual fuses that make up a PAL* Fuse map may be edited using the fuse map editor. Fuses may be changed from blown to unblown or vice-versa on a downloaded fuse map, a fuse map generated by assembly of source code, or directly in fuse memory.

Fuses may be edited one at a time from the front panel, or in line editor fashion from a terminal. In the examples that follow, assume that we are editing the Basic Gates fuse map of figure 3-8, representing the logic diagram of figure 3-9.

If "Device Selection Error" appears when you enter the fuse editor, you must specify the family code and pinout code to define the fuse map.

Front Panel Control

Enter the fuse editor with select code *EE*:

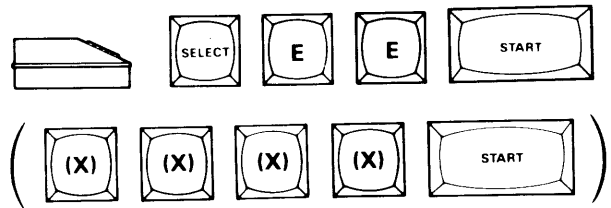

Model 29 Displays

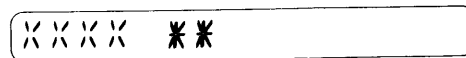

XXXX is decimal number of fuse being edited; **** is binary state of fuse number *XXXX* (00 or 01).

The desired fuse number for editing from the front panel may be scrolled to by using the *START* and *REVIEW* keys, or specified directly by entering the fuse number *XXXX*, as shown above. The data displayed on the right reflects the current state of the selected fuse:

- 01 = high-resistance, "blown" fuse
- 00 = low-resistance, fuse intact

Entering a 0 or a 1 while displaying a selected fuse will store that state for the fuse.

To change fuse number 98 in our Basic Gates example from unblown to blown:



Model 29 Displays

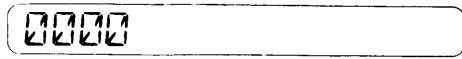

Fuse number

Enter the decimal fuse number, 98.

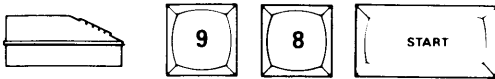

Model 29 Displays

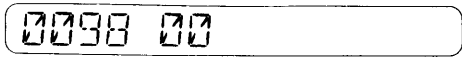

Fuse state

This display indicates that RAM data for fuse 98 is set for "don't program." To change it to a programmed (blown) state:



Model 29 Displays

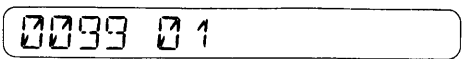

(Fuse number increments automatically.)

To decrement a fuse number:



Model 29 Displays



Terminal Control

Enter an *E* from the terminal Command mode:



Terminal Displays

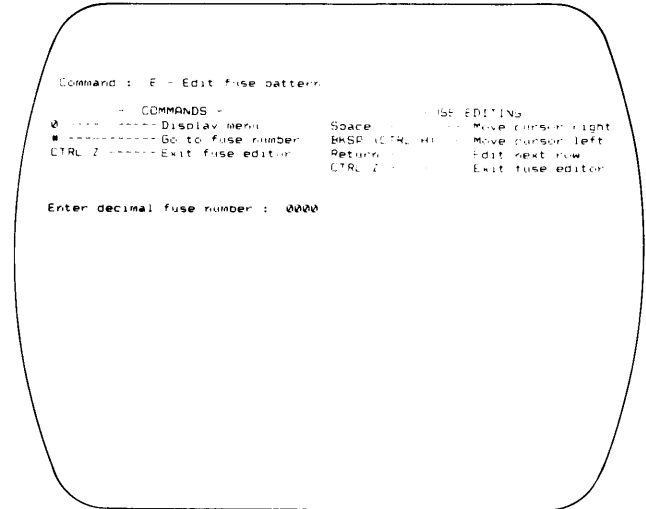

You may now specify a fuse number directly, or enter *RETURN* to display the first fuse row.

The fuse editor is a fixed-format line editor, with the first column of the displayed line reserved for command characters. A character entered in the first column (normally blank) is interpreted as a command and acted upon immediately; otherwise, fuse editing is not processed until a *RETURN* is entered (at any point on the line). The command characters recognized in the first column are 0 (zero) and #.

The fuse editor display (see figure 3-14) shows the specified fuse number followed by the next *N* consecutive fuses, where *N* is the number of fuses in one row of the selected PAL. Any fuse number may be specified, regardless of row boundaries, and the display will follow this convention. Thus, entering *RETURN* at any time moves the editor to the fuse one row down from the previously specified fuse. Index marks are shown over every tenth fuse in the row displayed, for easy location of fuses beyond the one specified. Also, note that the fuse display may be changed from X/- to 0/1 with select code *CE* or main menu command *G* (see subsection 3.5.12).

In operation, the fuse editor copies the selected row to a temporary buffer where all editing changes are made. Then, when a command or *RETURN* is entered, the editing buffer is examined for legal characters before copying back to the fuse map. You are not allowed to proceed to another row until all characters are legal in the current row. Typing a *CTRL Z* to exit the fuse editor from an untested edited row will leave the row in its original state.

To edit a fuse row, use the following procedure:

1. Move the cursor back and forth along the displayed row using *SPACE* and *BACKSPACE* until it is positioned over the fuse to be changed.
2. Press the desired symbol to enter it into the editing buffer as the fuse state.
3. Enter 0 (zero) or # in the command character position at any time to display the menu or move to a specific fuse number.
4. Press *RETURN* at any time to move to the next row.
5. Press *CTRL Z* at any time to exit the fuse editor.

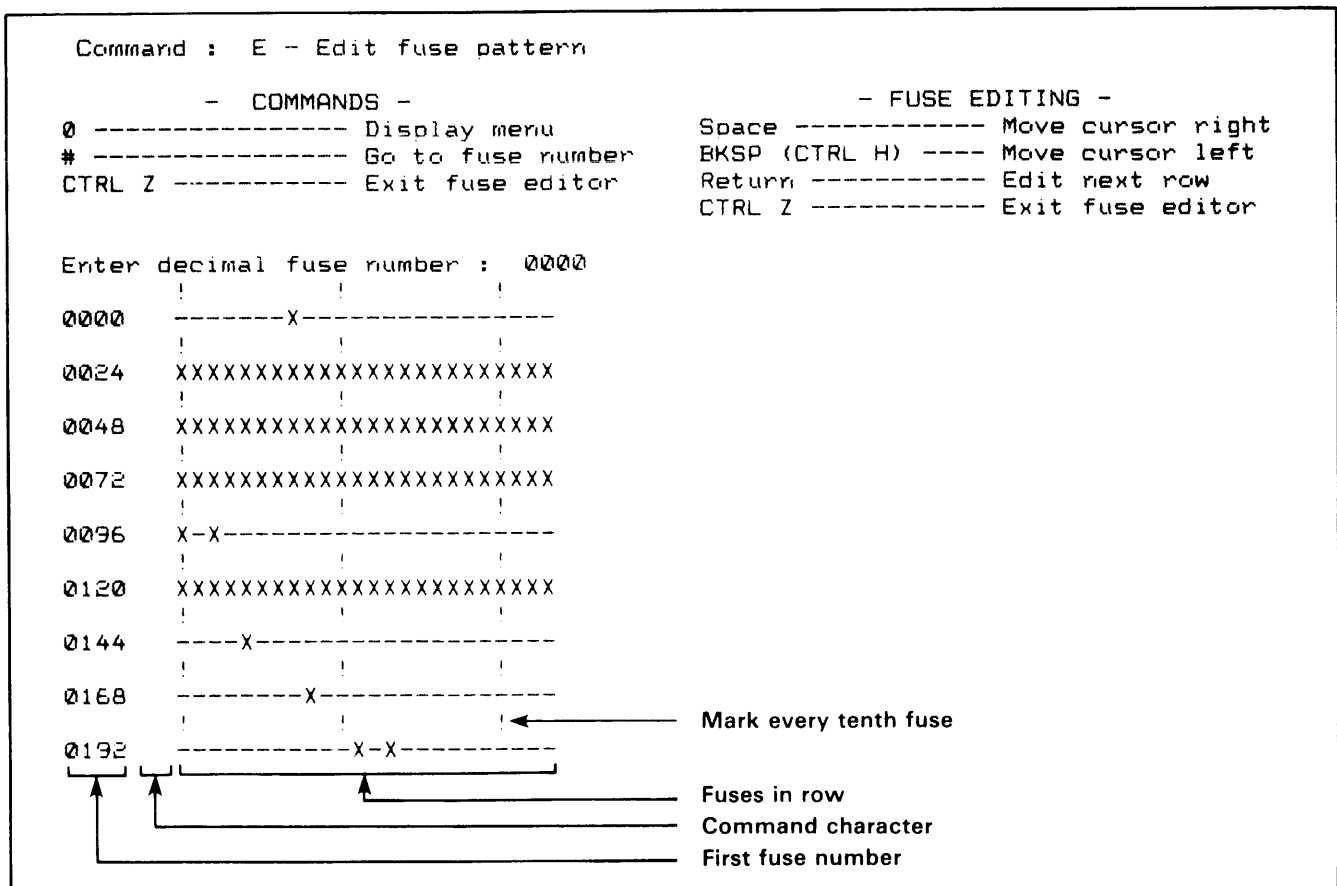

Figure 3-14. Default Fuse Editor Pattern

Editing fuse number 98 in our example may be done in two ways. As one method, you can enter the fuse editor and type *RETURN* until the desired row appears (beginning with fuse 0096), resulting in a display that matches the device data sheet, and then space three times to locate fuse 98. The display in this case will resemble figure 3-14.

Alternatively, fuse number 98 may be directly specified. When this is done, a fuse "row" is displayed which begins with fuse number 0098 and does not match any of the rows in the logic diagram of figure 3-9. Fuse number 98 may now be modified without counting spaces, and subsequent *RETURNS* will jump to the fuses directly below fuse 98 in the same column (122, 146, 170, etc.). Figure 3-15 shows the display when this method is used.

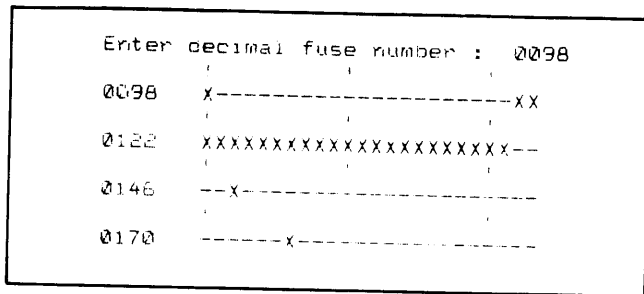

Figure 3-15. Starting Fuse Not On Row Boundary

3.5.11 DISPLAY CONFIGURATION NUMBER

This command displays the configuration number of the adapter firmware. Configuration numbers are used as serial numbers for firmware.

Front Panel Control

Enter *SELECT EF* from the front panel:

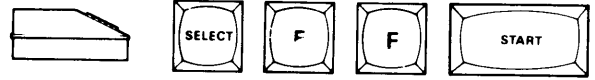

Model 29 Displays



Terminal Control

Enter an *F* from the terminal command mode:



Terminal Displays

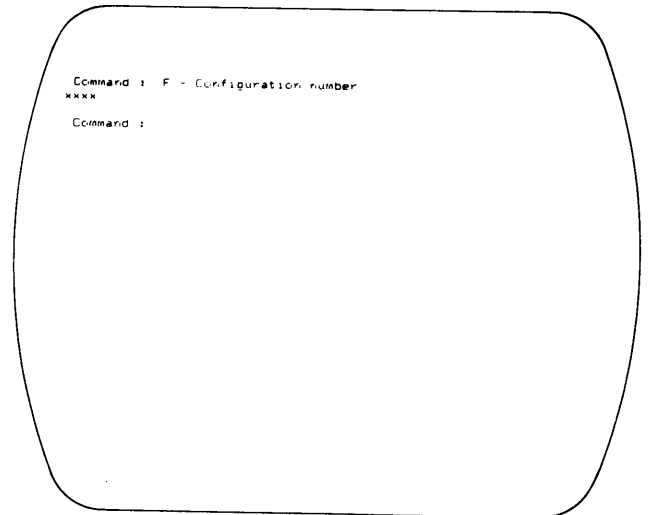

NOTE

XXXX is the configuration number of the firmware in the adapter plugged into the PLDS.

3.5.12 SELECT ATTRIBUTES

This command allows you to select one of two options for any of six attributes, as shown below. The only options available to the PALASM and H & L design adapters are those numbered 0 thru 7:

OPTION

DESCRIPTION



Echo (full duplex): PLDS echoes all characters received at the serial port.



No echo (half duplex).

NOTE

The default echo mode will depend upon the programmer being used. The Model 29 and 100A programmers will power up in the "no echo" mode, while the Model 19 will power up in the echo mode.



JEDEC full mode: described by the JEDEC standard (JC-42-1-81-62). This is the default state.



JEDEC kernel mode: selects the kernel mode (see appendix A of the LogicPak™ manual for kernel mode definition).



Fuse display X : displays an unprogrammed fuse as "X" and a programmed fuse as a ". This is the default state.



Fuse display 0/1: displays an unprogrammed fuse as "0" and a programmed fuse as "1".



End upload with ETX: PLDS terminates an upload operation (serial data transmission) with an ETX character (ASCII hex 03). *This is the default state.*



End upload with CTRL Z: ends the upload with a CTRL Z.

An underblow condition occurs when the programmer RAM indicates that a particular fuse should be blown and the device in the socket shows the fuse to be unblown. An overblow condition occurs when the programmer RAM indicates that a fuse is unblown, yet the part shows it to be blown.



Disable underblow/overblow display: disables this attribute.



Enable underblow/overblow display: enables this attribute.



Two-pass functional verify: performs the normal two-pass functional verify at VCC voltages above and below nominal.



One-pass functional verify: speeds up the testing cycle by doing only a one-pass functional verify at the nominal VCC voltage.

Front Panel Control

To access the attributes from the front panel, do the following:

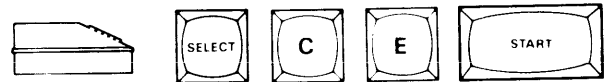

Model 29 Displays

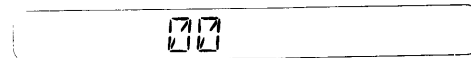

To change any attribute, enter the code number from those given above, where the (X) is shown in the following key sequence.

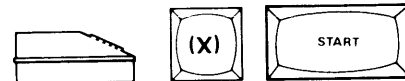

Model 29 Displays

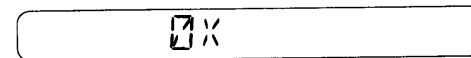

Terminal Control

To access the attributes from the terminal, enter a *G* from the command mode.



Terminal Displays

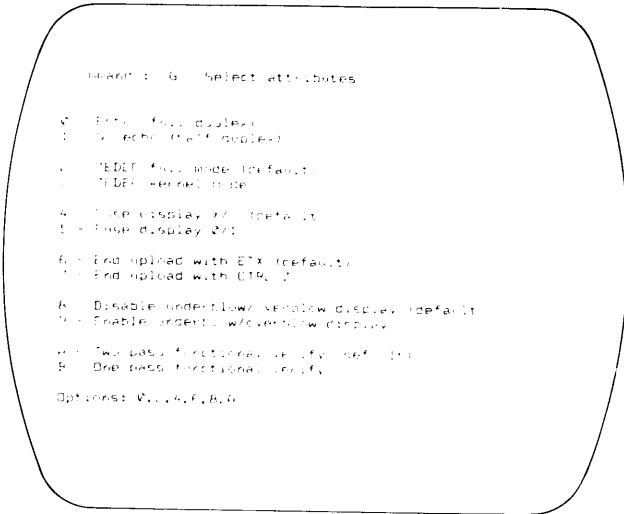

To change an attribute or attributes from the terminal, space or backspace (*CTRL H*) to the appropriate attribute(s) and enter the new value. The edit session is terminated by a *RETURN* if the edited attribute(s) are to be saved or by a *CTRL Z* if they are not to be saved. If an invalid value is entered, the line will be repeated, including the invalid data, waiting for the correct value(s) to be entered.

3.5.13 EXIT COMMANDS

During terminal mode, a *CTRL Z* will exit specific operating modes. When using the design adapters, this function is also used to terminate the change, insert, and edit modes.

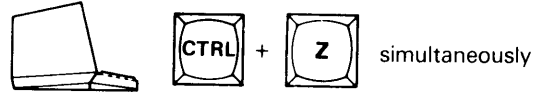

Terminal Displays

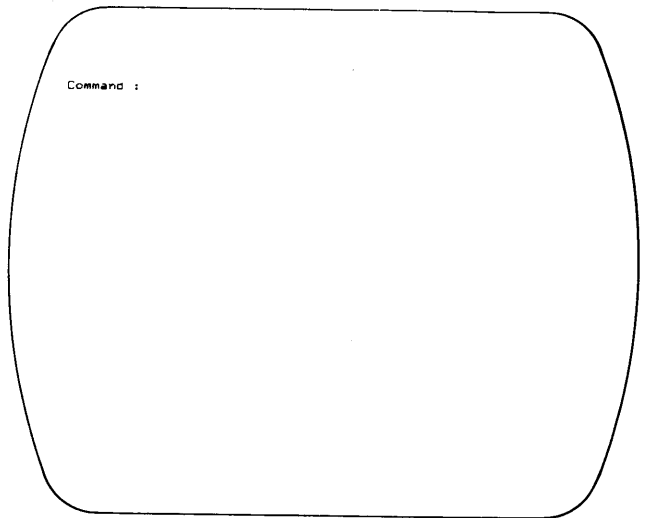

The *ESC* (escape) key is used to terminate all PLDS operations and return control to the front panel. This must be done before removing an adapter or the LogicPak™.

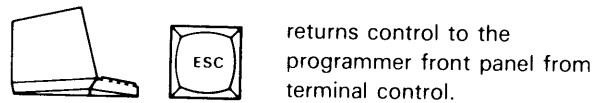

returns control to the programmer front panel from terminal control.

SECTION 4

CALIBRATION AND TROUBLESHOOTING

4.1 OVERVIEW

WARNING

The instructions in this section are for qualified service personnel only. Do not attempt to perform them unless you are qualified.

The material in this section is provided to help you keep your LogicPak™ and P/T adapter in optimum operating condition. For users who prefer to do their own calibration, detailed procedures, including measurement charts and timing diagrams for each device, are provided. The basic procedures to set up the LogicPak™ in the calibration mode are described in subsection 4.2.

4.2 CALIBRATION

The need for calibration varies with the amount of use your LogicPak™ receives. Generally, we suggest calibration whenever: (1) programming yields fall below the manufacturer's recommended minimums, (2) when troubleshooting has been completed, or (3) if your company policy requires periodic calibration certification. Because the LogicPak™ must be calibrated with an adapter installed and the values vary with different adapters, the detailed calibration procedures, measurement charts, and timing diagrams are provided in this manual. The calibration setup procedure is described in this section.

NOTE

If calibration or repair is required, but you lack the facilities to accomplish it, contact the nearest Data I/O Service Center. Because of the different programmer mainframes and adapters, this manual does not attempt to cover all areas of programmer calibration. Instead, it lists the steps necessary to calibrate only the LogicPak™ and adapter.

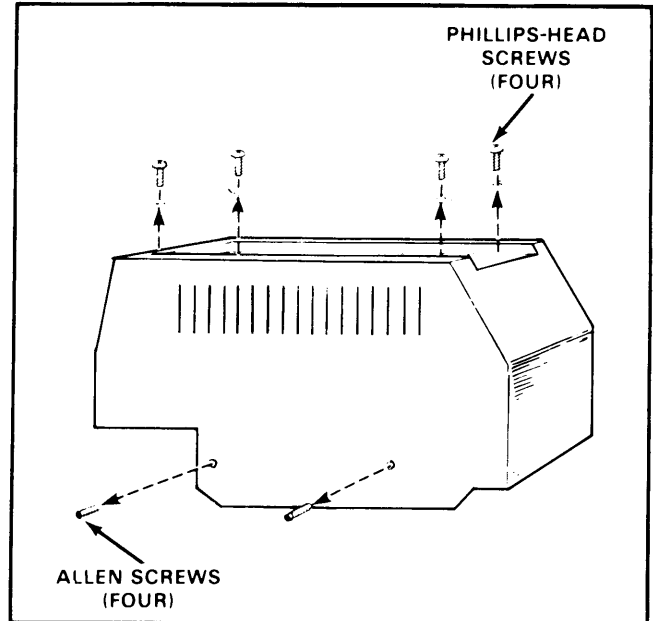

Figure 4-1. LogicPak™ Cover Removal

To prepare the LogicPak™ for calibration:

1. Remove the adapter (if any) from the LogicPak™ (see subsection 2.3).
2. Remove the four Phillips-head screws on the top of the LogicPak™ cover (see figure 4-1).
3. Remove the two Allen screws on each side of the LogicPak™ cover (see figure 4-1).
4. Lift the cover off the circuit board cage assembly.
5. Plug the adapter into the connector on the pin driver board as shown in figure 4-2.
6. Plug the LogicPak™ into the programmer.

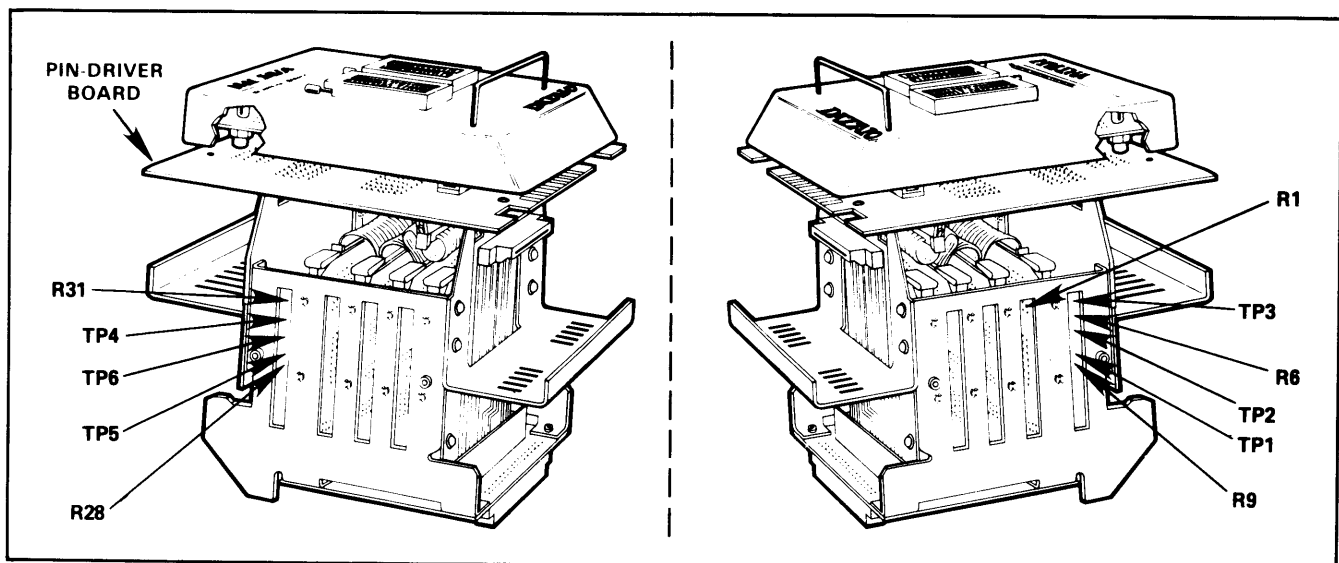

Figure 4-2. Calibration Equipment Setup

Calibration of the LogicPak™ and adapter consists of three parts:

1. Power supply calibration--measures the DC supply voltages of the programmer. All other voltages depend on these supplies; therefore, this part of the calibration procedure must be done first. Refer to your programmer manual.
2. DC calibration--consists of measuring and adjusting critical DC voltage levels generated by the LogicPak™ and by the adapter.
3. Waveform observation--enables observation of waveforms on an oscilloscope to ensure compliance with the device manufacturers' critical voltage and timing specifications.

Because the first part of the calibration procedure (power supply calibration) varies with the type of programmer you have, this manual refers you to your programmer manual for details on power supply calibration. DC calibration is discussed in subsection 4.2.1 and waveform observation is detailed in subsection 4.2.2. For information on how to carry out these steps on various programmers, consult your programmer manual.

The following equipment is necessary to calibrate the LogicPak™:

- 3½-digit digital voltmeter (DVM)
- Dual-trace oscilloscope (Tektronix 465 or equivalent)

4.2.1 DC CALIBRATION (Steps 1-10 and 12)

These DC calibration procedures enable you to adjust critical DC voltage levels generated by the LogicPak™ and adapter. To follow these procedures, use the measurement chart at the back of this section (table 4-3), which contains the information necessary for all DC calibration tests. This information is included on the measurement chart in columns with the following headings:

- Step No.--tells which step to use for each test. Step numbers are set at the programmer keyboard and reflected in the display.
- Test No.--identifies individual tests.
- Test description--identifies the functions being tested.
- Measurement location--tells which socket pins or circuit board test points to probe for measuring voltages.
- Measurement--specifies allowable measurement ranges. If a reading falls outside the range and you cannot adjust it to within the range, do not use the LogicPak™ until the problem is corrected.
- Adjustment location--tells which potentiometer to adjust if a measurement is out of range.
- Comments--gives special instructions for particular tests.

The DC calibration procedures follow.

CAUTION

Remove all devices from the sockets before entering the calibration mode (see subsection 3.4.3 for details). Calibration voltages may damage any device in the LogicPak™ sockets.

1. Turn the programmer power on.

NOTE

If left in calibration steps 1 through 7 for more than 5 minutes without a front panel key depression, the machine will reset itself.

2. Put the programmer into the calibration mode by following the key sequences in table 4-1. The table also explains how to increment or decrement the step number and how to enter calibration at an advanced step (which is required during the waveform calibration part of the process).

Table 4-1. Key Sequence To Access the Calibration Mode

Pro-grammer System	Key Sequence To Enter Calibration Mode	To Increment Step No.	To Decrement Step No.
19	Press <i>SELECT</i> Press <i>C2</i> Press <i>ENTER</i> Enter Step Number ^(a) Press <i>START</i>	Press <i>ENTER</i>	Press <i>REVIEW</i>
Model 29	Press <i>SELECT</i> Press <i>C1</i> Press <i>START</i> Enter Step Number ^(a) Press <i>START</i>	Press <i>START</i>	Press <i>REVIEW</i>
100A	Press <i>SELECT</i> Press <i>12</i> Enter Step Number ^(a) Press <i>START</i>	Press <i>START</i>	Press <i>BACKSPACE</i>
(a)Optional			

3. Perform the general calibration steps (steps 1-10 and 16) on the measurement chart.

CAUTION

If the LogicPak™ fails the second step on the measurement chart, do not proceed to the next step. The hardware must pass this step or further testing may damage the LogicPak™.

If the LogicPak™ fails any step on the measurement chart, do not continue to the next step. Refer to table 4-2, which lists error codes and descriptions. Subsequent tests will not give valid results unless all preceding steps are passed and adjustments made.

For each general calibration step on the measurement chart:

- Take measurement readings at the device sockets or test points indicated in the measurement chart.
- Ground the DVM to pin 10 on a 20-pin socket, to pin 12 on a 24-pin socket, or to pin 14 on a 28-pin socket.
- The oscilloscope trigger point is called out on the measurement chart photographs.
- The adjustment potentiometers on the waveform generator and the T/rise comparator card enable you to make adjustments when your measurements do not match the measurement chart; figure 4-3 shows the location of these adjustment points.
- Access each new step by pressing *START* (or *ENTER*). The new step number will appear on the display when the LogicPak™ is ready for the next step. To return to a previous test, press the *REVIEW* (or *BACKSPACE*) key.

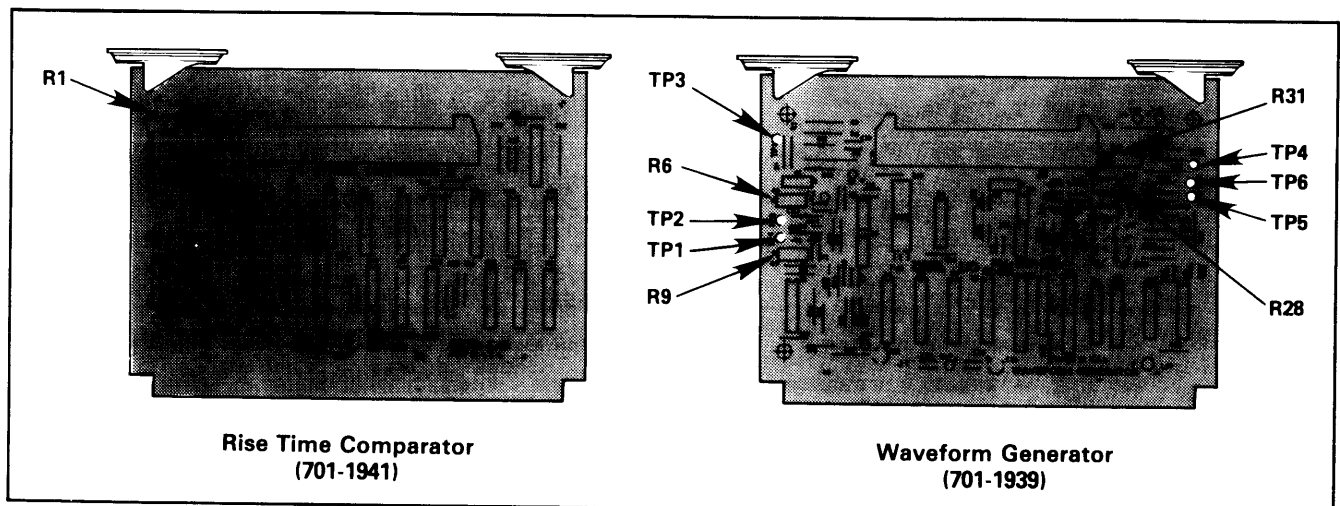

Figure 4-3. LogicPak™ Test and Adjustment Locations

Table 4-2. PLDS Error Codes

ERROR CODE	DESCRIPTION	ACTION
21*	Illegal-Bit Error	The programmer is asked to leave intact a fuse which is already blown. Examine programmer RAM and the device's data.
22*	Programming Error	An attempt to blow a fuse was made and failed. Try the programming sequence again. If the second attempt also fails, try another device. If both devices produce this error, check the calibration of the LogicPak™. If calibrated correctly, contact your local Data I/O office.
25*	No Socket Adapter	Insert appropriate socket adapter.
30	No (or Invalid) Device Selected	Enter valid device family and pinout codes (refer to table A-1 in Appendix A).
31*	Overcurrent	Hardware error in LogicPak™ or shorted device. Substitute a known-good device or consult the troubleshooting section of the LogicPak™.
32*	Backward Device/V _{CC} Overcurrent	(1) Device plugged in backward; turn it around. (2) V _{CC} overcurrent, probably caused by a faulty device.
33	Extended RAM Fail (Occurs only when PALASM adapter is installed.)	PALASM source file exceeds source buffer size.
34	Invalid Device Selected	Incorrect family and pinout codes entered. Enter proper family pinout code. This error occurs in computer remote control only.
35	Source Equation Translation Error	Check equation buffer by connecting terminal to examine the equation buffer. This error code lets the operator know that an error exists in the source equations when the programmer is not controlled by a terminal.
36	Begin RAM Pointer Not = 0000	Refer to programmer manual to reset the begin RAM pointer to zero. This error usually occurs when changing from one programming pak to another.
37	Invalid Device-Related Operation	Verify, program, or other illegal operation was attempted, with a design adapter installed.
38	Calibration Step Error	(1) Indicates you have selected an incorrect calibration step, or (2) a program operation is attempted prior to exiting calibration—exit the calibration mode (refer to the programmer manual).
63	RAM Write Error	System RAM failure. Refer to programmer manual or contact Data I/O service representative.
65	Firmware Sum-Check Error	This indicates that the EPROM firmware in the LogicPak™ or adapter may have changed since the unit was shipped. Contact Data I/O service representative. Do not continue operation until the situation is corrected.
70*	DAC Error, V _{CC}	See subsection 4.4 (troubleshooting) of LogicPak™ manual.

*These errors do not apply to design adapters.

(Continued)

Table 4-2. PLDS Error Codes (Continued)

ERROR CODE	DESCRIPTION	ACTION
71*	DAC Error, Bit Switch Number 1	See subsection 4.4 of LogicPak™ manual.
72*	DAC Error, Bit Switch Number 2	See subsection 4.4 of LogicPak™ manual.
73*	DAC Error, CE	See subsection 4.4 of LogicPak™ manual.
74*	Logic Fingerprint™ Test Verify Error	Indicates one of the following Logic Fingerprint™ errors: (1) Device passed fuse verify but failed Logic Fingerprint™ test—defective device. (2) Operator has entered wrong test-sum. (3) Device cannot be tested with Logic Fingerprint™ (refer to subsection 1.3 for the limitations of the Logic Fingerprint™ test).
75	Structured Test Verify Error	The device passed fuse verify but failed structured test—defective device. Check structured test vectors and make sure they are correct. If not, enter the correct vectors. The vector could be invalid, or the operator may have miskeyed a valid vector.
76	Self-Test Error	This indicates failure in the LogicPak™. Consult subsection 4.4 (troubleshooting) of LogicPak™ manual or contact your Data I/O service representative.
77	Security Fuse Programming Error	(1) Indicates that the security fuse option cannot be programmed in the installed device, or (2) there is no security fuse option available for this type of device.
78*	No Fuse Verify Set	Indicates you have tried to program the device with the verify-option mode set for 2. The verify option will not allow this. When this error code displays, select E6 and enter 0 or 1, and then you will be allowed to program the device.
79*	Preload Not Implemented	The preload algorithm is not implemented for this device.
81	Parity Error	A parity error occurred while receiving serial data.
82	Checksum Error	Indicates an incorrect transmission of data from a peripheral to the serial port, including fuse data, CRs, STX, etc.
84	Invalid Data	See subsection 3.5.9 of LogicPak™ manual.
91	Fuse Address Error	See subsection 3.5.9 of LogicPak™ manual.

*These errors do not apply to design adapters.

^aSee LogicPak™ manual for locations of I/O pins.

4.2.2 WAVEFORM OBSERVATION

Programming waveforms of your LogicPak™ can be observed with an oscilloscope and compared with the timing diagrams at the end of this section. In this way, timing and magnitude relationships can be measured against known specifications to confirm that the LogicPak™ is performing to the device manufacturer's specifications. Step 13 displays the verification waveforms, and step 14 displays the programming waveforms for selected family and pinout codes and fuse numbers. When step 15 is called, the waveforms will reflect the programming algorithm for only the fuses to be programmed as specified in RAM. To alter the state of the individual fuses, refer to subsection 3.5.10, Edit Fuse Pattern. Because the LogicPak™ generates many waveforms, and all calibration adjustments are accomplished in DC calibration, it is necessary only to observe waveforms for commonly used devices or devices that are presenting yield problems. These measurements can be performed on any device by entering the appropriate family and pinout codes and fuse number (if appropriate).

4.2.3 EXPLANATION OF TIMING DIAGRAMS

This manual contains a set of timing diagrams for the AMD family of logic devices. The timing diagrams show critical waveforms for a specific device but may be verified for any of the AMD devices by entering the appropriate family pinout code before invoking the calibration mode. To use these diagrams and photographs, read the information provided below and refer to the sample timing diagram (figure 4-4).

1. Family and Pinout Code Number--corresponds to the family and pinout code numbers of the device.
2. Waveform Variables--lists the minimum and maximum parameter values; voltage and timing parameters other than those listed in this table are to be considered noncritical with a $\pm 10\%$ tolerance.
3. Notes--important information pertaining to a timing diagram.
4. Waveform Names--the manufacturer's reference to the pin being observed.
5. Layout Sequence Number--used as a reference point within each diagram.
6. Delay Time Position--indicates the time from the start of the main sweep to the start of the delay time.
7. Oscilloscope Ground Reference--ground pin (pin 10) of the socket.
8. Time-Base Setting--Horizontal positioning of the waveforms is not critical and may vary slightly from the photographs. The important observation is the timing relationship between the waveforms in the photographs. You can adjust this timing relationship on your oscilloscope to set convenient reference points. By considering any time-base variance, you can also make time comparisons between photographs. The time base is always the same for different waveforms in the same photograph.
9. Voltage--indicates volts per division. The one in the upper-left corner is for the top trace and the one in the lower-left corner is for the bottom trace.
10. Pin Name and Number--the device pin name and socket pin number where the waveform can be observed.

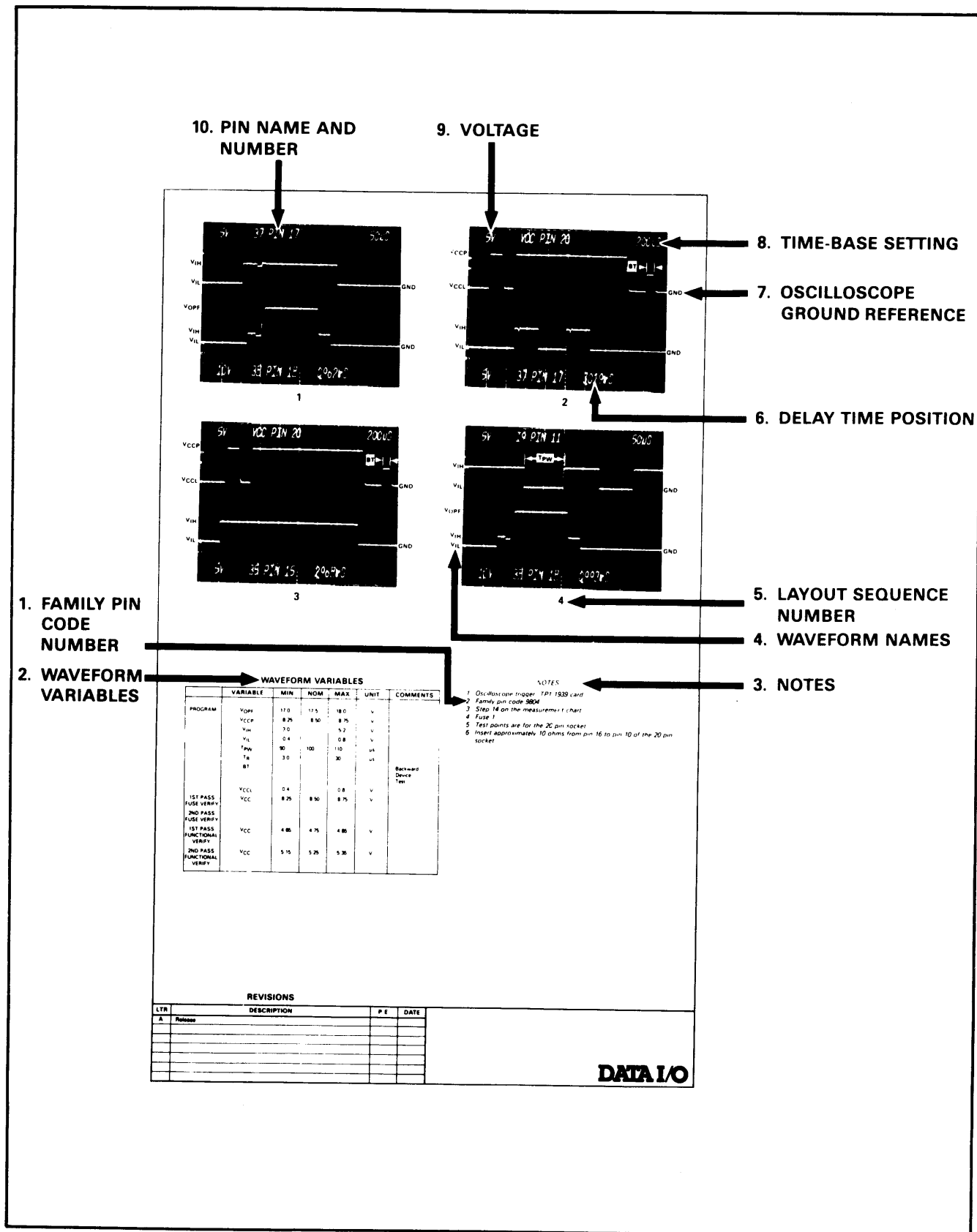

Figure 4-4. Sample Timing Diagram

Measurement Chart

Table 4-3. Measurement Chart

REVISIONS								
LTR	DESCRIPTION		P.E	DATE				
A	Release				Measurement Chart for AMD P/T Adapter 715-0038-001			
STEP	TEST NO.	TEST DESCRIPTION	MEASUREMENT LOCATION Socket/pins or circuit board test points	MEASUREMENT			ADJUSTMENT LOCATION	COMMENTS Ground pin 10 or 12 ^a
				MIN	NOM	MAX		
1	1	All pins low	24-pin/all pins 20-pin/all pins	-0.4		0.8		CAUTION ^b
2	2	Self-test, sink drivers						See table 4-4 if errors result; errors must be corrected to continue. Possible errors are A0-DF.
3	3	LED test 1						Confirm 24-pin LED on, 20-pin off
	4	Comparator reference	701-1939/TP5	10.20	10.24	10.28	R28/701-1939	CAUTION ^c
	5	V _{CC} supply	24-pin/pin 24 20-pin/pin 20	11.9	12.0	12.1	R9/701-1939	Load with 50 Ω 5W resistor to ground. ^{c,d}
	6	CE supply	24-pin/pin 13	19.8	20.0	20.2	R31/701-1939	Load with 100 Ω 5W resistor to ground. ^{c,d}
	7	Bit supply SW 1	24-pin/pin 19	19.8	20.0	20.2	R6/701-1939	Load with 100 Ω 5W resistor to ground. ^{c,d}
	8	Bit supply SW 2	24-pin/pin 14	19.6		20.4	N/A	Load with 100 Ω 5W resistor to ground. ^{c,d}
	9	DAC reference	701-1939/TP6	4.7		5.3	N/A	

CAUTION: DO NOT POWER DOWN AFTER STEP 1.

^aConnect the ground of the DVM to ground pin 10 on a 20-pin socket, to pin 12 on a 24-pin socket, or to pin 14 on a 28-pin socket.^bDo not leave programmer unattended in calibration mode beyond step 1.^cInsert load resistor after pressing START; remove immediately after performing test.^dVoltage levels are for calibration purposes only and are not the specified levels of the device manufacturer. For manufacturer-specific levels, refer to step 12.

Sheet 1 of 5

Table 4-3. Measurement Chart (Continued)

LTR		DESCRIPTION	P E	DATE	Measurement Chart for AMD P/T Adapter 715-0038-001				
A		Release							
STEP	TEST NO.	TEST DESCRIPTION	MEASUREMENT LOCATION Socket/pins or circuit board test points	MEASUREMENT			ADJUSTMENT LOCATION	COMMENTS Ground pin 10 or 12 ^a	
				MIN	NOM	MAX			
4	10	Self-test source drivers						See table 4-4 if errors result. Possible errors are E0-FF. ^b	
	11	LED test 2						Make sure that the 20-pin socket LED is on and 24-pin LED is off. ^b	
	12	Socket pins TTL high	24-pin/pins 2,4,6,8,10,13,16,18,19,21,23 20-pin/pins 2,4,6,8,10,13,15,17,19	3.0		5.2			
	13	Socket pins TTL low	24-pin/pins 1,3,5,7,9,11,14,15,17,20,22 20-pin/pins 1,3,5,7,9,12,14,16,18	-0.4		0.8			
5	14	Socket pins TTL low	24-pin/pins 2,4,6,8,10,13,16,18,19,21,23 20-pin/pins 2,4,6,8,11,13,15,17,19, LEDs off	-0.4		0.8		If error 76 occurs during steps 5-16, perform steps 2 and/or 4 for diagnostics. ^b	
	15	Socket pins TTL high	24-pin/pins 1,3,5,7,9,11,14,15,17,20,22 20-pin/pins 1,3,5,7,9,12,14,16,18, LEDs off	3.0		5.2			
6	16	Socket pins source	24-pin/pins 2,4,6,8,10,13,14,16,18,19, 21,23 20-pin/pins 2,4,6,8,11,13,15,17,19	9.5		10.5			
	17	Socket pins TTL high	24-pin/pins 1,3,5,7,9,11,15,17,20,22 20-pin/pins 1,3,5,7,9,12,14,16,18	3.0		5.2		Note ^b	

^aConnect the ground of the DVM to ground pin 10 on a 20-pin socket, to pin 12 on a 24-pin socket, or to pin 14 on a 28-pin socket.

^bVoltage levels are for calibration purposes only and are not the specified levels of the device manufacturer. For manufacturer-specific levels, refer to step 12.

Table 4-3. Measurement Chart (Continued)

LTR		DESCRIPTION	P.E	DATE	Measurement Chart for AMD P/T Adapter 715-0038-001				
A		Release							
STEP	TEST NO.	TEST DESCRIPTION	MEASUREMENT LOCATION Socket/pins or circuit board test points	MEASUREMENT			ADJUSTMENT LOCATION	COMMENTS Ground pin 10 to 12 ^a	
				MIN	NOM	MAX			
7	18	Socket pins TTL high	24-pin/pins 2,4,6,8,10,13,14,16,18,19, 21,23	3.0		5.2		Note ^b	
			20-pin/pins 2,4,6,8,11,13,15,17,19					Note ^b	
	19	Socket pins source	24-pin/pins 1,3,5,7,9,11,15,17,20,22	9.5	--	10.5		Note ^b	
			20-pin/pins 1,3,5,7,9,12,14,16,18	9.5		10.5			
8	20	Backward device test	24-pin/pin 24 20-pin/pin 20					CAUTION ^a	
								Load with 10 Ω to ground, confirm error 32.	
9	21	Overcurrent test						CAUTION ^a	
		Low-range V _{CC}	24-pin/pin 24 20-pin/pin 20					Load with 20 Ω 5W to ground, confirm error 31.	
		Low-range CE switch	24-pin/pin 13					Load with 30 Ω 5W to ground, confirm error 31.	
		Low-range bit switch 1	24-pin/pin 19					Load with 30 Ω 5W to ground, confirm error 31.	
		Low-range bit switch 2	24-pin/pin 14					Load with 30 Ω 5W to ground, confirm error 31.	
								CAUTION ^a	

^aInsert load resistor after pressing START; remove immediately after performing test.

^bVoltage levels are for calibration purposes only and are not the specified levels of the device manufacturer. For manufacturer-specific levels, refer to step 12.

Table 4-3. Measurement Chart (Continued)

LTR		DESCRIPTION		P.E	DATE	Measurement Chart for AMD P/T Adapter 715-0038-001					
A		Release									
STEP	TEST NO.	TEST DESCRIPTION	MEASUREMENT LOCATION Socket/pins or circuit board test points		MEASUREMENT			ADJUSTMENT LOCATION	COMMENTS		
					MIN	NOM	MAX		Ground pin 10 or 12 ^a		
10	22	Overcurrent test							Same loads as step 9, confirm no errors. ^a		
		High-range	24-pin/pin 24	20-pin/pin 20							
	23	High-range V _{CC}	24-pin/pin 24	20-pin/pin 20					Load with 5Ω 5W to ground, confirm error 31.		
									Load with 12Ω 5W to ground, confirm error 31.		
	23	High-range CE switch	24-pin/pin 13						Load with 12Ω 5W to ground, confirm error 31.		
		High-range Bit switch 1	24-pin/pin 19						Load with 12Ω 5W to ground, confirm error 31.		
		High-range Bit switch 2	24-pin/pin 14						Load with 12Ω 5W to ground, confirm error 31.		
11	24	Waveform observation security fuse	Refer to timing diagram (step 11) for test points, family and pinout codes, and waveforms.						Verify waveforms per timing diagrams. ^b		
12	25	Static programming							Notes ^{b,c}		
		Levels V _{CC Gen} V _{IHH}	20-pin/pin 20		5.0		5.5		Voltages are for fuse ∅.		
		CE Gen V _{IHH}	20-pin/pin 1		10.0		12.0		Notes ^{b,c}		
		BIT Gen V _{IHH}	20-pin/pin 19		18.0		22.0		Levels can be measured for any fuse by entering its fuse number.		
									See manual for instructions.		

^aConnect the ground of the DVM to ground pin 10 on a 20-pin socket, to pin 12 on a 24-pin socket, or to pin 14 on a 28-pin socket.

^bFamily and pinout codes must be entered or error 30 will be flagged. See the timing diagrams for valid codes.

^cA fuse number must be entered or default to fuse ∅ will occur.

Table 4-3. Measurement Chart (Continued)

REVISIONS				Measurement Chart for AMD P/T Adapter 715-0038-001						
LTR	DESCRIPTION			P.E	DATE					
A	Release									
STEP	TEST NO.	TEST DESCRIPTION	MEASUREMENT LOCATION Socket/pins or circuit board test points	MEASUREMENT			ADJUSTMENT LOCATION	COMMENTS Ground pin 10 or 12 ^a		
				MIN	NOM	MAX				
13	26	Waveform observation	Refer to timing diagram					Notes ^{b,c}		
		Verify array	(step 13) for test points, family and pinout codes, and waveforms					Waveforms are for fuse number entered.		
14	27	Waveform observation	Refer to timing diagram					Notes ^{b,c}		
		Program array	(step 14) for test points, family and pinout codes, and waveforms							
15	28	Waveform observatibn	No timing diagram supplied; waveforms					Load RAM for desired pattern. ^b		
		Program all fuses (opt)	will vary depending on RAM data							
16	29	Rise time adjust						Load with 100 Ω 2W 5% res. to GND.		
		CE switch		9.0us	10.0us	11.0us	R1/701-1941	Adjust R1 for T_{R2} as shown on		
		Bit switch 1		8.0us		12.0us	N/A	timing diagram (this step		
		Bit switch 2		8.0us		12.0us	N/A	number).		
17	30	Supply linearity						Verify waveforms per timing		
		VCC Supply	24-pin/pin 24					diagram.		
		CE supply	24-pin/pin 16							
		Bit supply	24-pin/pin 19							

^aConnect the ground of the DVM to ground pin 10 on a 20-pin socket, to pin 12 on a 24-pin socket, or to pin 14 on a 28-pin socket.

Measurement Chart Photographs

Measurement Chart

PROGRAM ELECTRONICS RISE TIME WAVEFORM

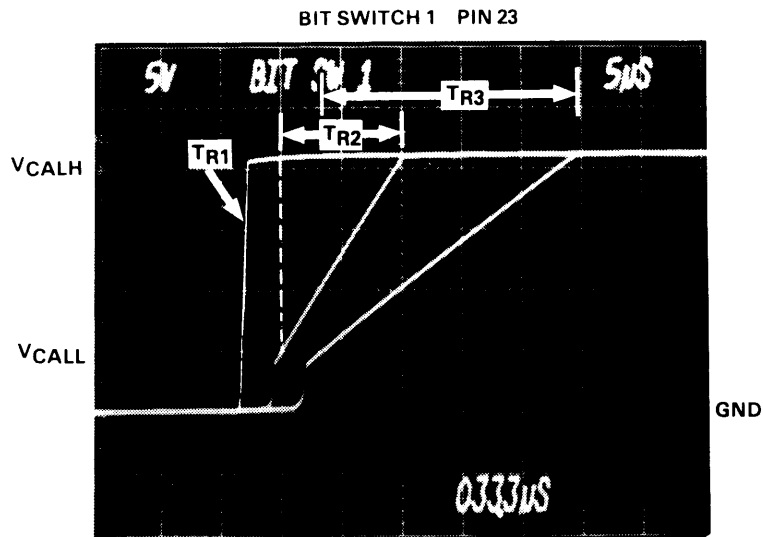
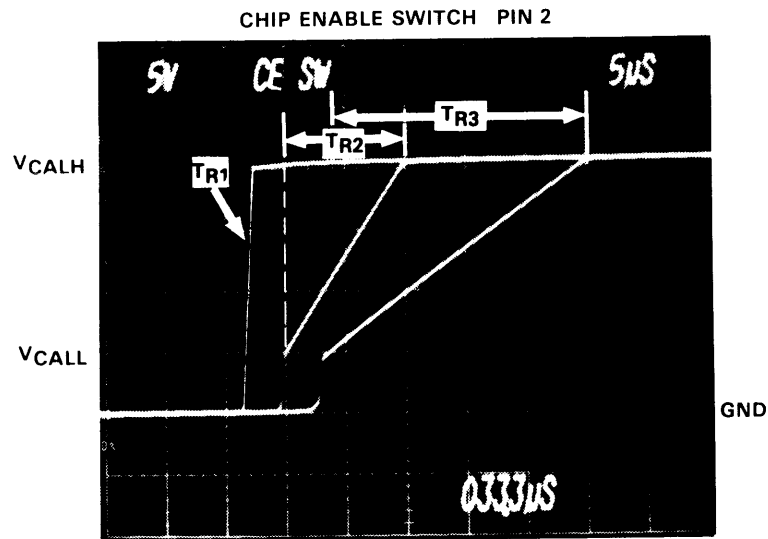

DATE	REV	REVISION RECORD	DR	CK
2/5/85		Release	KIM	

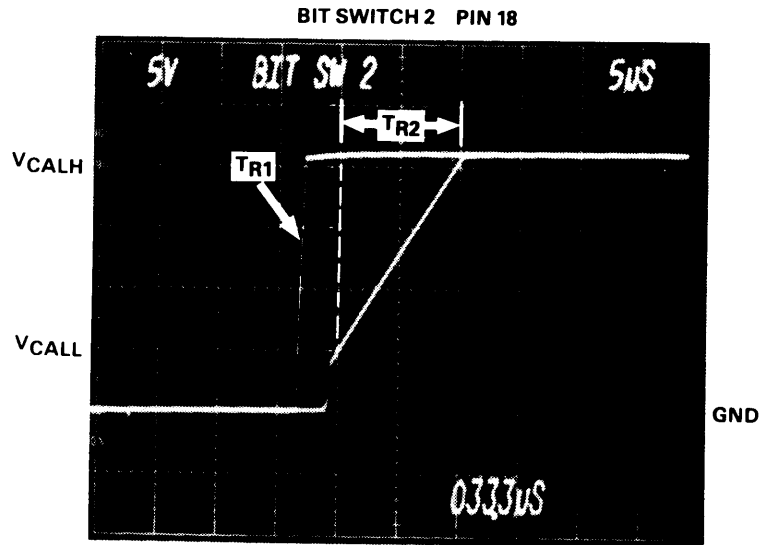

	VARIABLE	MIN	NOM	MAX	UNIT	COMMENTS
PROGRAM	V _{CALH}	--	20	--	V	Adjust R1 on 1941 card for T _{R2} CE SW as shown. Verify that others are within limits. Rise times are measured from V _{CALL} to V _{CALH} . (Voltage levels for reference only.)
	V _{CALL}	--	5	--	V	
	T _{R1} CE SW	.450	.650	.850	μs	
	T _{R2} CE SW	9.0	10.0	11.0	μs	
	T _{R3} CE SW	15.0	20.0	25.0	μs	
	T _{R1} BIT SW	.450	.650	.850	μs	
	T _{R2} BIT SW	8.0	10.0	12.0	μs	
	T _{R3} BIT SW	15.0	20.0	25.0	μs	

NOTES

1. Oscilloscope trigger: TP1 1939 card.
2. Step 16 on the measurement chart.
3. Test points are for the 24-pin socket.
4. BIT SW rise time limits are for both BIT SW1 and BIT SW2.
5. All waveforms shown loaded by 100 Ω 2W 5% to ground.

Measurement Chart

PROGRAM ELECTRONICS

SUPPLY LINEARITY

VCC SUPPLY

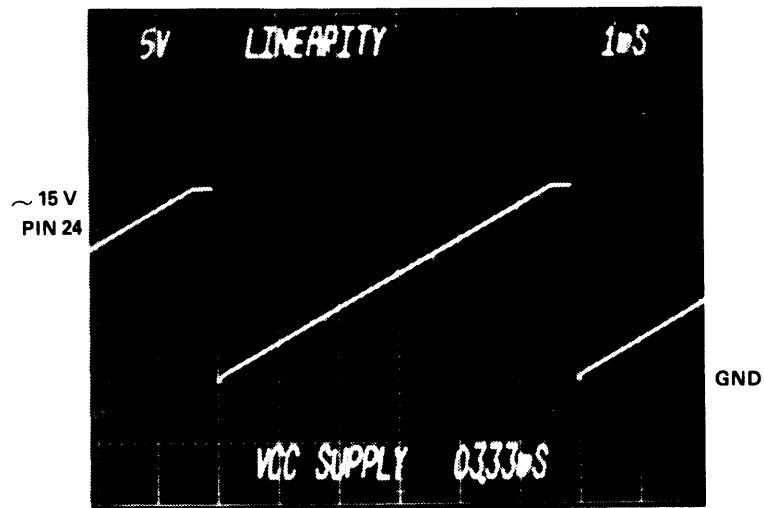

CE SUPPLY

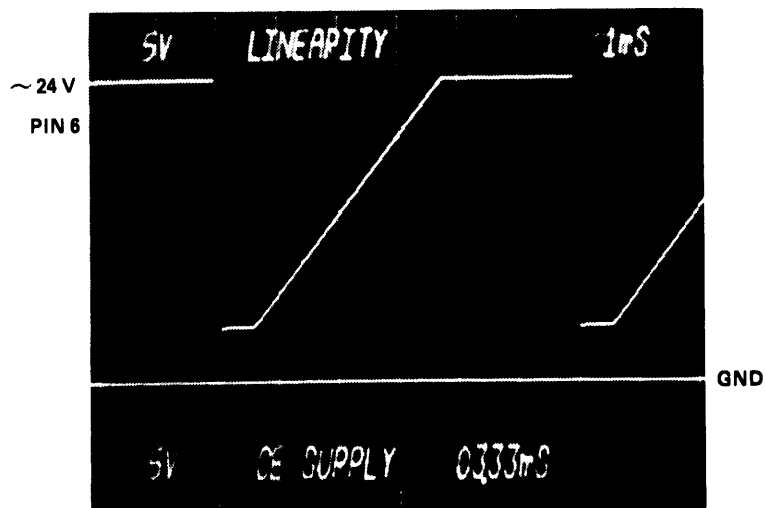

DATE	REV	REVISION RECORD	DR	CK
		Release		

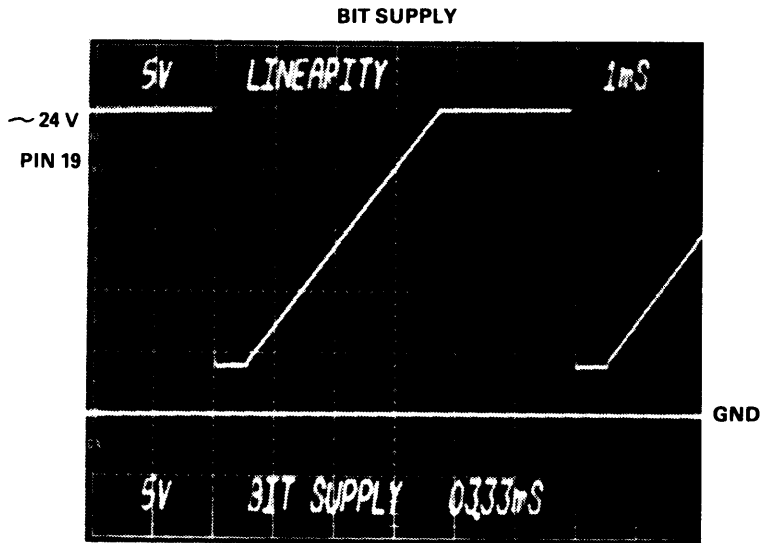

NOTES

1. Oscilloscope trigger: TP1 1939 card.
2. Step 17 on the measurement chart.
3. Test points are for the 24-pin socket.

Timing Diagrams

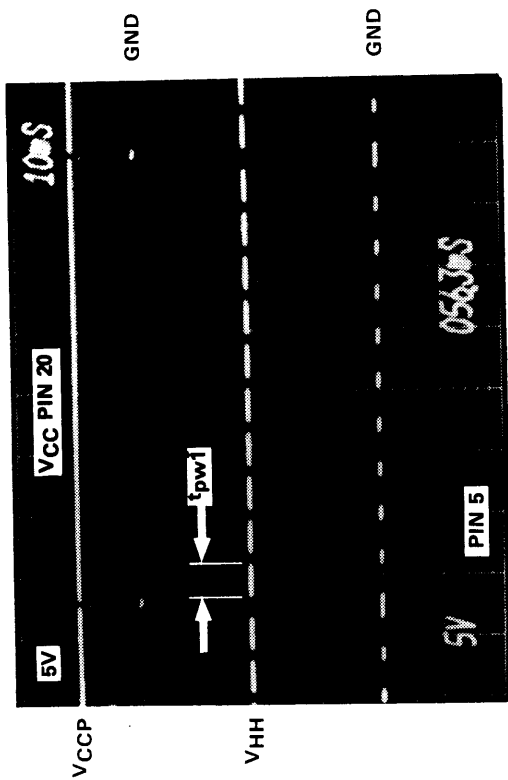

1

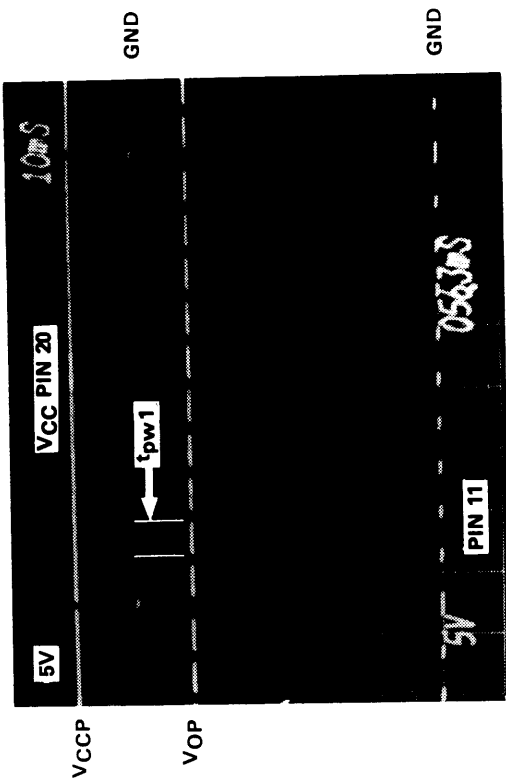

2

FAMILY CHARACTERISTICS

	VARIABLE	MIN	NOM	MAX	UNIT	COMMENTS
PROGRAM	V _{CCP}	5.0	5.2	5.5	V	Backward Device Test
	V _{HH}	10.0	11.0	12.0	V	
	V _{OP}	18.0	20.0	22.0	V	
	V _{IL}	-0.4	--	0.8	V	
	V _{IH}	3.0	--	5.2	V	
	T _{PW₁}	4.0	5.0	10.0	ms	
BT	--	--	--	--		
SECURITY FUSE PULSES		-	10	-	Pulses	

NOTES

1. Oscilloscope trigger: TP1 1939 card.
2. Family pin code 9717.
3. Step 11 on the measurement chart.
4. Test points are for the 20-pin socket.

REVISIONS

LTR	DESCRIPTION	P.E.	DATE
		<i>KMM</i>	7/12/94

**SECURITY FUSE WAVEFORM
TIMING DIAGRAM
FAMILY CODE 9717**

DATA I/O

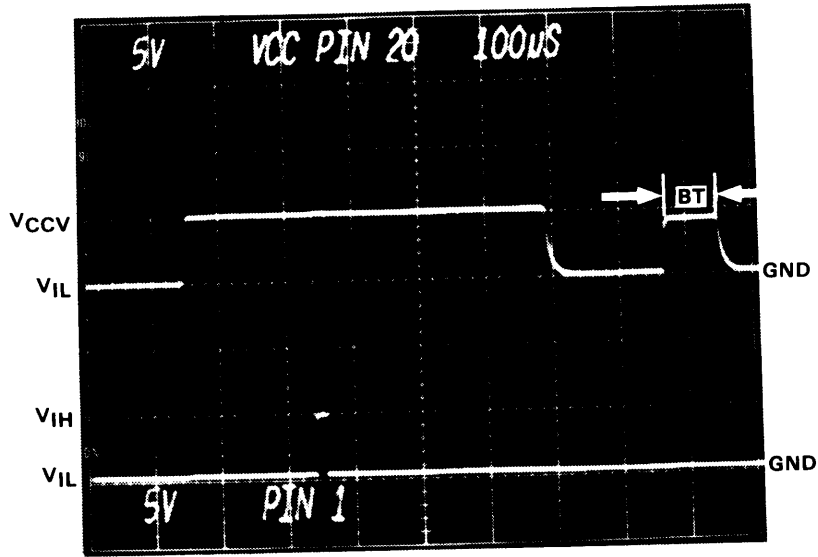

1

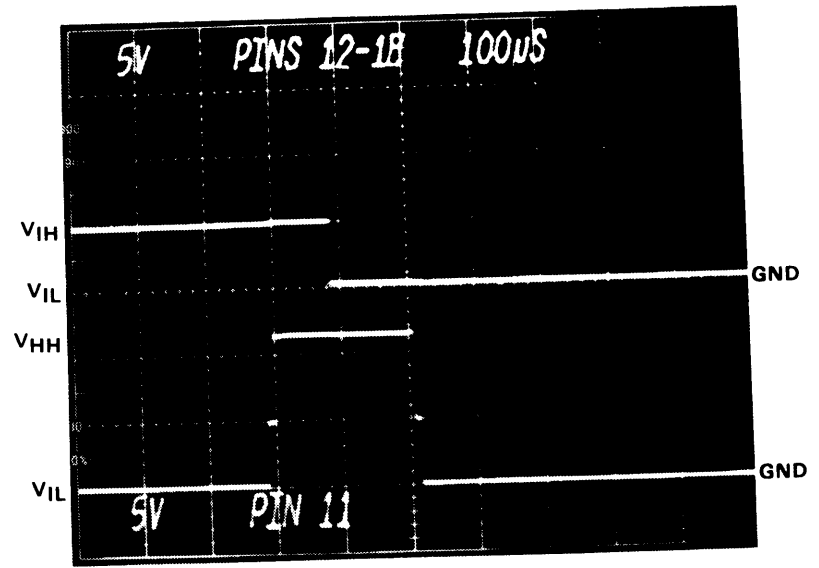

2

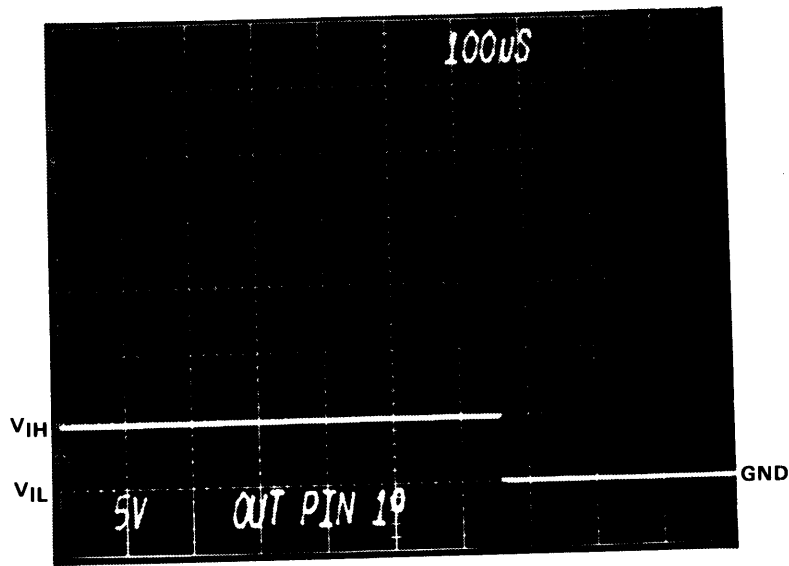

3

FAMILY CHARACTERISTICS

	VARIABLE	MIN	NOM	MAX	UNIT	COMMENTS
PROGRAM	VCCV	4.8	5.0	5.2	V	Backward Device Test
	VIL	-0.4	--	0.8	V	
	VIH	3.0	--	5.2	V	
	BT	--	--	--	--	
1ST PASS FUSE VERIFY	VCC	4.10	4.30	4.40	V	
2ND PASS FUSE VERIFY	--	5.50	5.70	5.90	V	
1ST PASS FUNCTIONAL VERIFY	VCC	4.65	4.75	4.85	V	
2ND PASS FUNCTIONAL VERIFY	VCC	5.15	5.25	5.35	V	

NOTES

1. Oscilloscope trigger: TP1 1939 card.
2. Family pin code 9717.
3. Step 13 on the measurement chart.
4. Fuse \emptyset .
5. Test points are for the 20-pin socket.

REVISIONS

LTR	DESCRIPTION	P.E.	DATE
A	Release	<i>KIM</i>	<i>6/27/83</i>

**VERIFICATION WAVEFORM
TIMING DIAGRAM
FAMILY CODE 9717**

DATA I/O

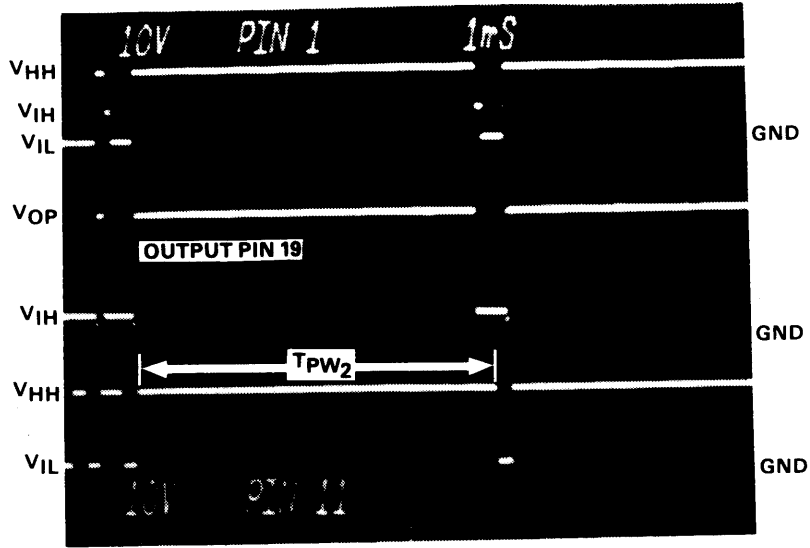

1

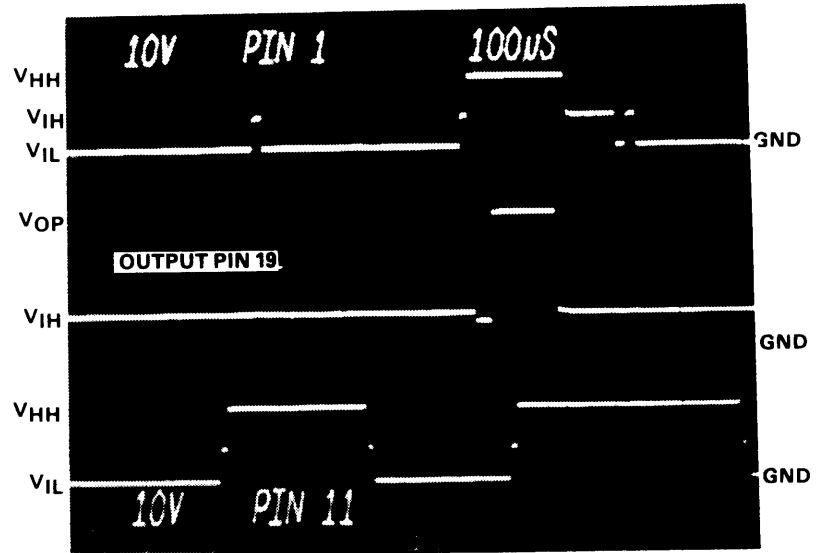

2

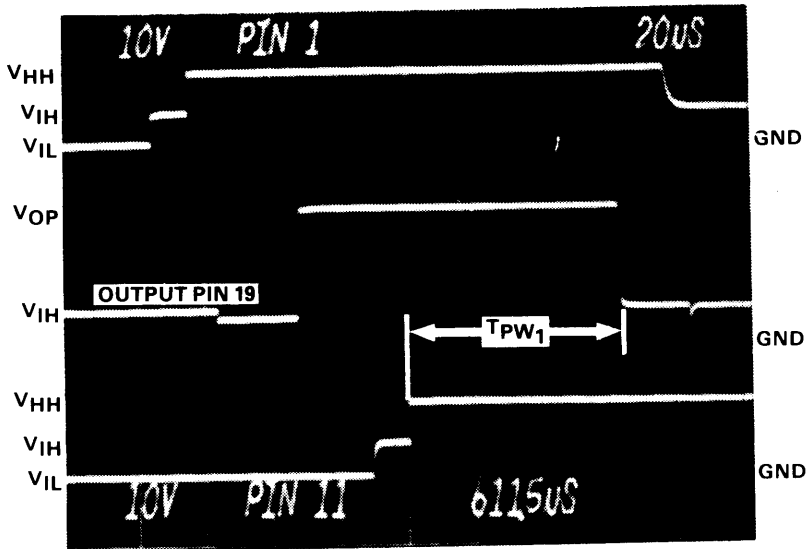

3

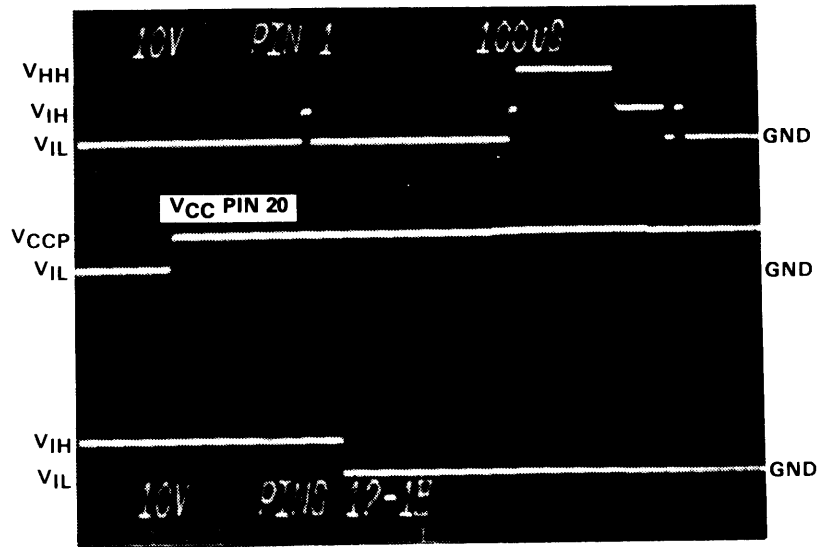

4

FAMILY CHARACTERISTICS

	VARIABLE	MIN	NOM	MAX	UNIT	COMMENTS
PROGRAM	VCCP	5.0	5.2	5.5	V	
	V _{HH}	10.0	11.0	12.0	V	
	V _{OP}	18.0	20.0	22.0	V	
	V _{IL}	-0.4	--	0.8	V	
	V _{IH}	4.0	--	5.2	V	
	T _{R1}	10	--	100	ns	
	T _{R2}	0.45	--	0.75	μs	
	T _{PW1}	40	50	100	μs	
	T _{PW2}	4	5	10	ms	
1ST PASS FUSE VERIFY	VCC	4.10	4.30	4.50	V	
2ND PASS FUSE VERIFY	--	5.50	5.70	5.90	V	
1ST PASS FUNCTIONAL VERIFY	VCC	4.65	4.75	4.85	V	
2ND PASS FUNCTIONAL VERIFY	VCC	5.15	5.25	5.35	V	
REJECT COUNT OPTION 0			11		Pulses	
REJECT COUNT OPTION 1			1		Pulses	

NOTES

1. Oscilloscope trigger: TP1 1939 card.
2. Family pin code 9717.
3. Step 14 on the measurement chart.
4. Fuse 0.
5. Test points are for the 20-pin socket.

REVISIONS

LTR	DESCRIPTION	P.E.	DATE
	Release	<i>KM</i>	<i>6/27/83</i>

**PROGRAMMING WAVEFORM
TIMING DIAGRAM
FAMILY CODE 9717**

DATA I/O

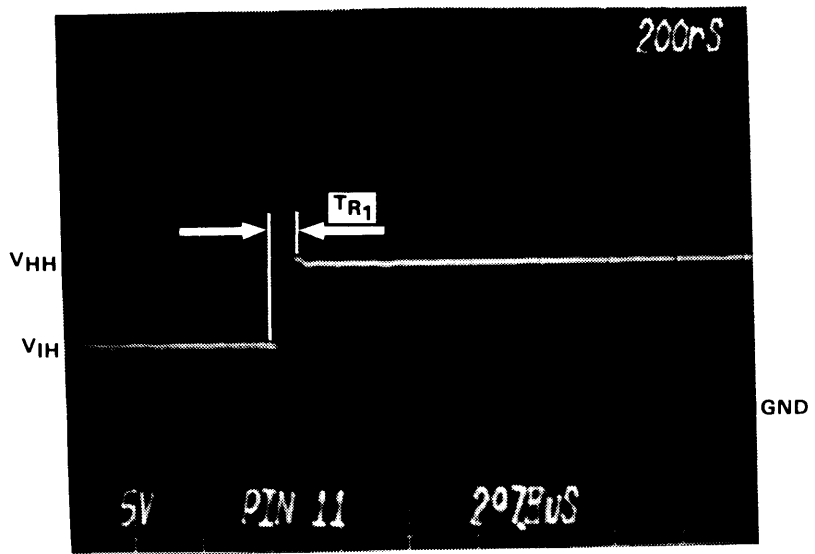

5

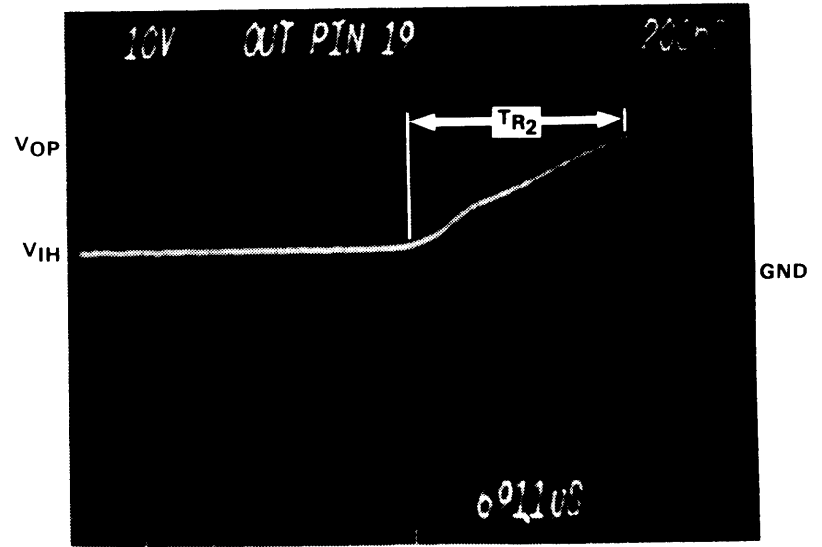

6

REVISIONS

LTR	DESCRIPTION	P. E.	DATE
	Release	KMI	6-27-83

**PROGRAMMING WAVEFORM
TIMING DIAGRAM
FAMILY CODE 9717**

DATA I/O

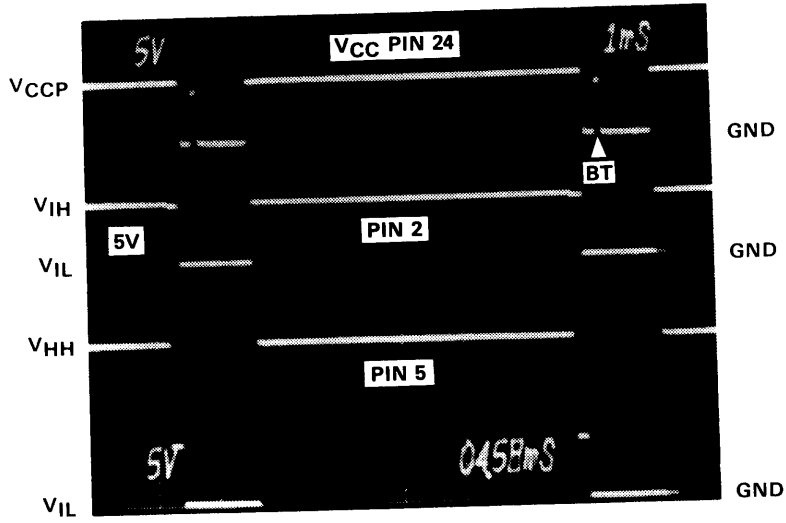

1

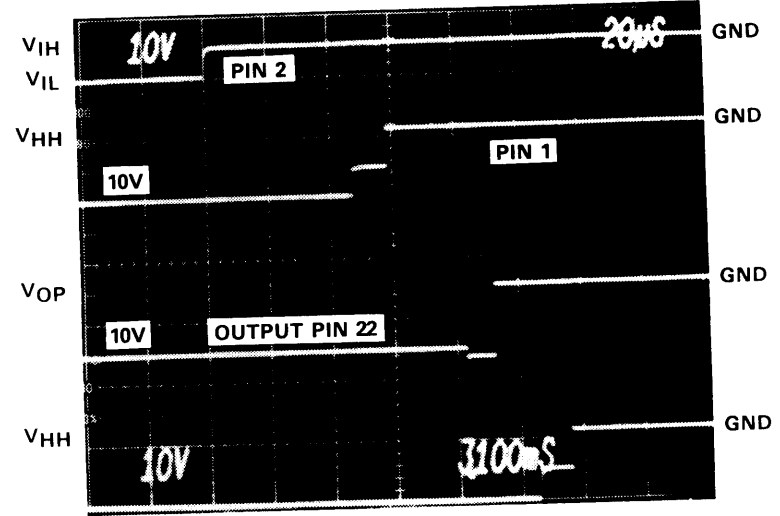

2

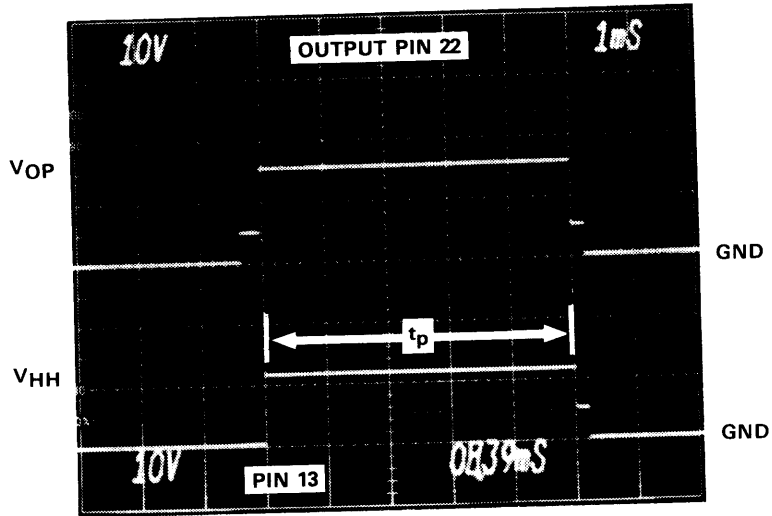

3

FAMILY CHARACTERISTICS

	VARIABLE	MIN	NOM	MAX	UNIT	COMMENTS
PROGRAM	V _{CCP}	5.0	5.2	5.5	V	
	V _{HH}	10.0	11.0	12.0	V	
	V _{OP}	14.0	15.0	16.0	V	
	V _{IL}	-0.4	--	0.8	V	
	V _{IH}	3.0	--	5.2	V	
	t _p	4.0	5.0	10.0	ms	
	BT	--	--	--	--	Backward Device Test
SECURITY FUSE PULSES			1		Pulses	

NOTES

1. Oscilloscope trigger: TP1 1939 card.
2. Family/Pinout code 9728.
3. Step 11 on the measurement chart.
4. Test points are for the 24-pin socket.

REVISIONS

LTR	DESCRIPTION	P.E.	DATE
	Release	<i>KMM</i>	<i>7/12/84</i>

**SECURITY FUSE
 WAVEFORM TIMING DIAGRAM
 FAMILY/PINOUT CODE
 9728**

DATA I/O

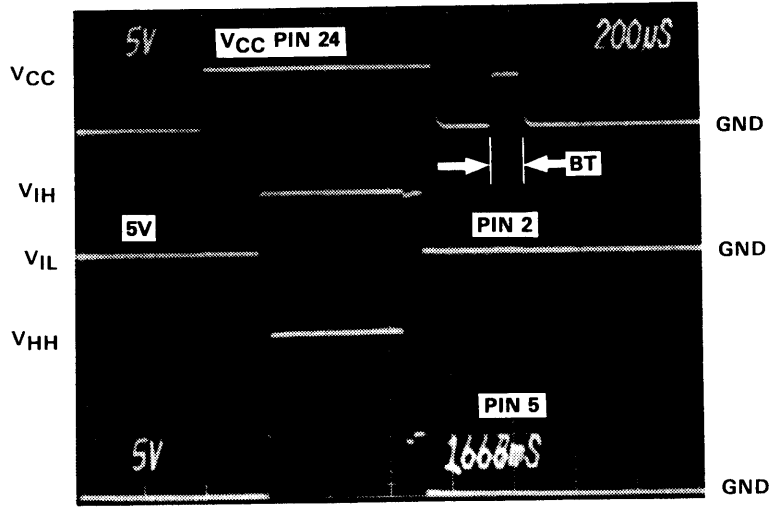

1

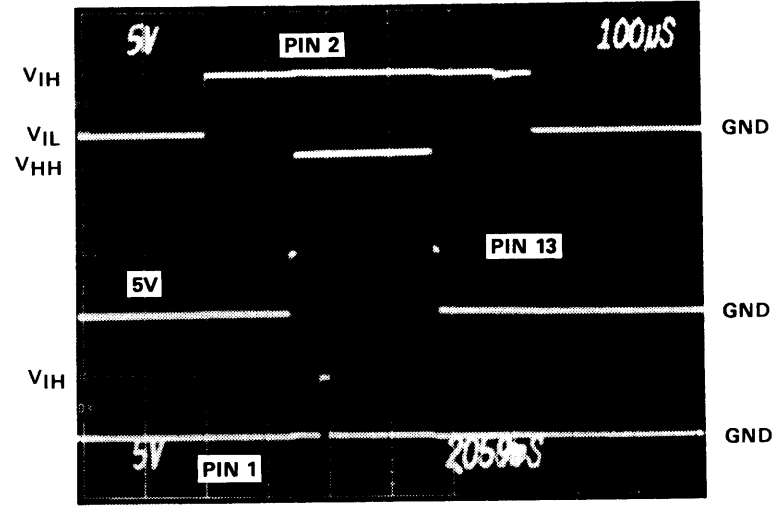

2

FAMILY CHARACTERISTICS

	VARIABLE	MIN	NOM	MAX	UNIT	COMMENTS
VERIFY	V _{HH}	12.0	13.0	14.0	V	Backward Device Test
	V _{IL}	-0.4	--	0.8	V	
	V _{IH}	3.0	--	5.2	V	
	BT	--	--	--		
1ST PASS FUSE VERIFY	V _{CC}	4.10	4.30	4.50	V	
2ND PASS FUSE VERIFY	V _{CC}	5.40	5.70	6.00	V	
1ST PASS FUNCTIONAL VERIFY	V _{CC}	4.65	4.75	4.85	V	
2ND PASS FUNCTIONAL VERIFY	V _{CC}	5.15	5.25	5.35	V	

NOTES

1. Oscilloscope trigger: TP1 1939 card.
2. Family/Pinout code 9728.
3. Step 13 on the measurement chart.
4. Test points are for the 24-pin socket.

REVISIONS

LTR	DESCRIPTION	P.E.	DATE
	Release	<i>KM</i>	7/12/84

**VERIFICATION WAVEFORM
TIMING DIAGRAM
FAMILY/PINOUT CODE
9728**

DATA I/O

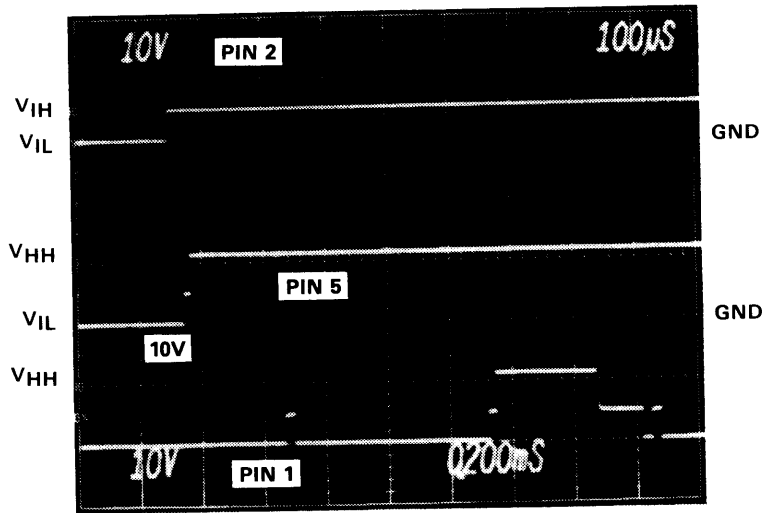

1

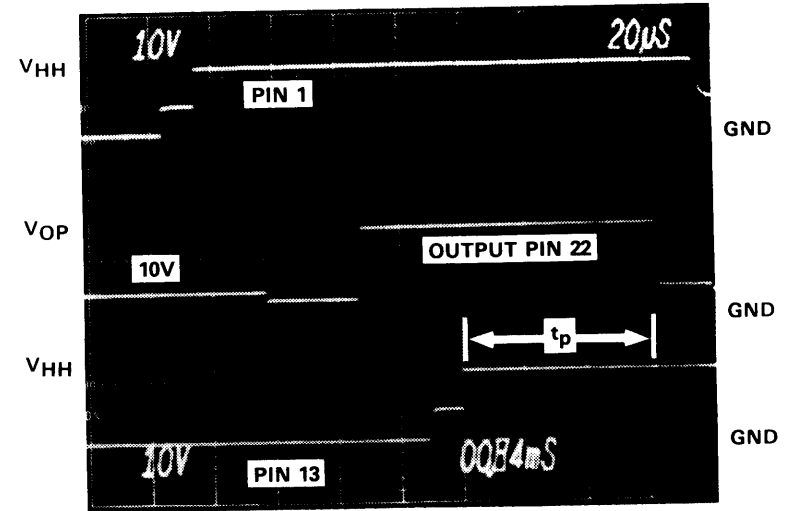

2

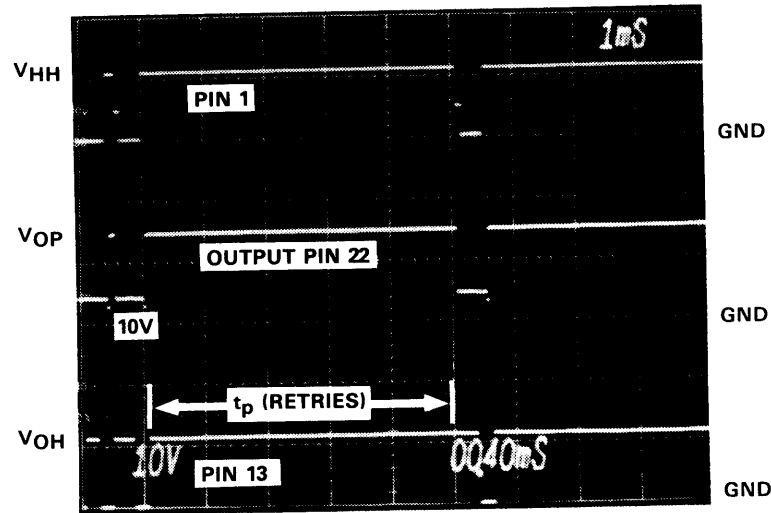

3

FAMILY CHARACTERISTICS

	VARIABLE	MIN	NOM	MAX	UNIT	COMMENTS
PROGRAM	VCCP	5.0	5.2	5.5	V	
	V _{HH}	10.0	11.0	12.0	V	
	V _{OP}	14.0	15.0	16.0	V	
	V _{IL}	-0.4	--	0.8	V	
	V _{IH}	3.0	--	5.2	V	
	t _p	40	50	100	μs	
	t _p (retries)	4	5	10	ms	
REJECT COUNT OPTION 0			11		Pulses	
REJECT COUNT OPTION 1			1		Pulses	

NOTES

1. Oscilloscope trigger: TP1 1939 card.
2. Family/Pinout code 9728.
3. Step 14 on the measurement chart.
4. Fuse 0.
5. Test points are for the 24-pin socket.

REVISIONS

LTR	DESCRIPTION	P.E.	DATE
	Release	KM	7/12/84

**PROGRAMMING WAVEFORM
TIMING DIAGRAM**

**FAMILY/PINOUT CODE
9728**

DATA I/O

CHIP ENABLE SWITCH PIN 2

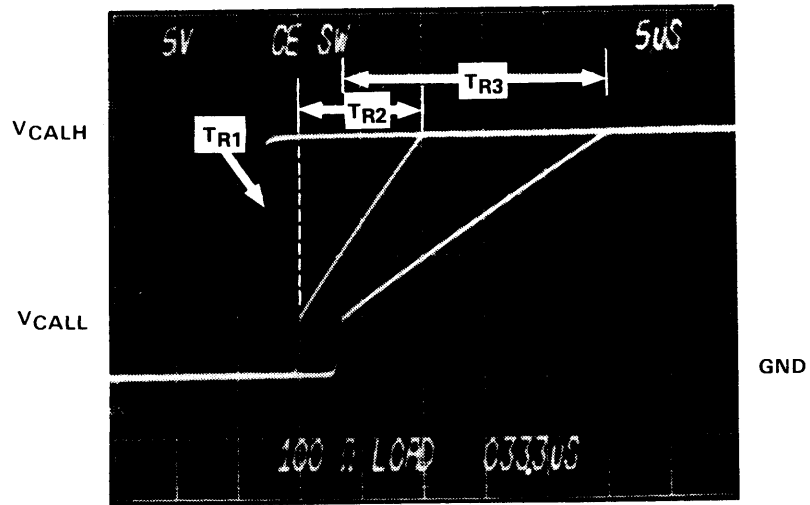

1

BIT SWITCH 1 PIN 23

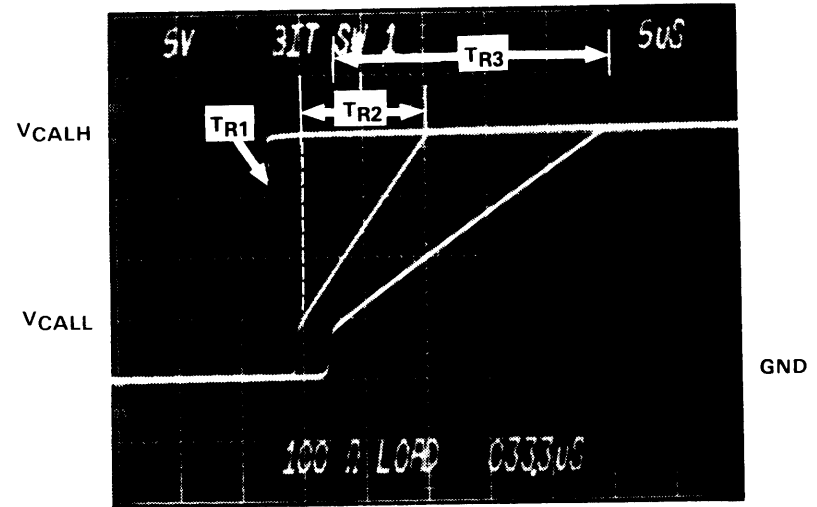

2

3IT SW 2

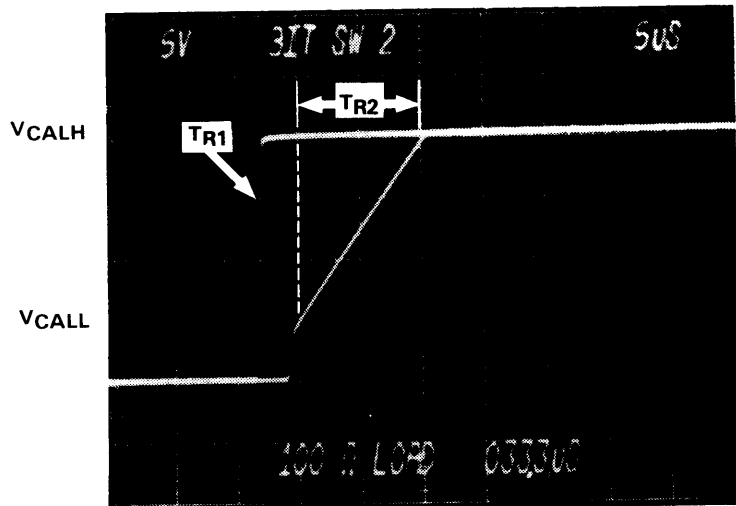

3

4

FAMILY CHARACTERISTICS

NOTES

	VARIABLE	MIN	NOM	MAX	UNIT	COMMENTS
PROGRAM	V _{CALH}	—	20		V	Adjust R1 on 1941 card for T _{R2} CE SW as shown. Verify that others are within limits. Rise times are measured from V _{CALL} to V _{CALH} (Voltage levels for reference only.)
	V _{CALL}	—	5		V	
	T _{R1} CE SW	.450	.650	.850	us	
	T _{R2} CE SW	9.0	10.0	11.0	us	
	T _{R3} CE SW	15.0	20.0	25.0	us	
	T _{R1} BIT SW	.450	.650	.850	us	
	T _{R2} BIT SW	8.0	10.0	12.0	us	
	T _{R3} BIT SW	15.0	20.0	25.0	us	

NOTES

1. Oscilloscope trigger: TP1 1939 card.
2. Step 16 on the measurement chart.
3. Test points are for the 24-pin socket.
4. BIT SW rise time limits are for both BIT SW1 and BIT SW2.
5. All waveforms shown loaded by 100 Ω 2W 5% to ground.

REVISIONS

LTR	DESCRIPTION	P. E.	DATE

DATA I/O

Table 4-4. Error Codes for Calibration

ERROR	I/O PIN^(a)	CONDITION	ERROR	I/O PIN^(a)	CONDITION
A0	1	Failure to read desired level on input register	D0	17	Failure to read desired TTL level on output pin
A1	2		D1	18	
A2	3		D2	19	
A3	4		D3	20	
A4	5		D4	21	
A5	6		D5	22	
A6	7		D6	23	
A7	8		D7	24	
A8	9		D8	25	
A9	10		D9	26	
AA	11		DA	27	
AB	12		DB	28	
AC	13		DC	29	
AD	14		DD	30	
AE	15		DE	31	
AF	16		DF	32	
B0	17	Failure to read desired level on input register	E0	1	Failure to read desired 10V level on desired output pin
B1	18		E1	2	
B2	19		E2	3	
B3	20		E3	4	
B4	21		E4	5	
B5	22		E5	6	
B6	23		E6	7	
B7	24		E7	8	
B8	25		E8	9	
B9	26		E9	10	
BA	27		EA	11	
BB	28		EB	12	
BC	29		EC	13	
BD	30		ED	14	
BE	31		EE	15	
BF	32		EF	16	
C0	1	Failure to read desired TTL level on output pin	F0	17	Failure to read desired 10V level on desired output pin
C1	2		F1	18	
C2	3		F2	19	
C3	4		F3	20	
C4	5		F4	21	
C5	6		F5	22	
C6	7		F6	23	
C7	8		F7	24	
C8	9		F8	25	
C9	10		F9	--	
CA	11		FA	27	
CB	12		FB	28	
CC	13		FC	--	
CD	14		FD	--	
CE	15		FE	--	
CF	16		FF	--	

^(a)See LogicPak™ manual for locations of I/O pins.

SECTION 5

CIRCUIT DESCRIPTION

5.1 INTRODUCTION

This section defines the functions of the 303A-004 AMD adapter's principal components. The circuit board assembly is depicted by a block diagram accompanied by a written description.

5.2 GENERAL ARCHITECTURE

The adapter interfaces with the LogicPak™. When it is installed, it customizes the PLDS to support AMD logic devices.

5.3 COMPONENT LAYOUT

A block diagram is shown in figure 5-1, and the schematic is at the back of this manual. The adapter board routes all the necessary signals required to perform fuse operations and functional tests of the logic devices. These signals are

routed to a socket to support the devices. When the socket is enabled by the family and pinout codes, the LED above the socket will light.

A backward test circuit connects to the V_{CC} pin of each socket. The circuitry tests the orientation of the logic device in the socket. If it is incorrect, an error code will be flagged and operation will stop. The test method limits power to the device, thereby preventing damage to it.

Firmware specific to the AMD logic is resident in an EPROM, which receives its address and select inputs from the LogicPak™. The PROM outputs are buffered by an octal data gate, whose inputs feed back to the data base within the LogicPak™. Fuse programming, verification, and functional testing algorithms are stored in PROM and are referenced by stored family and device pinout codes.

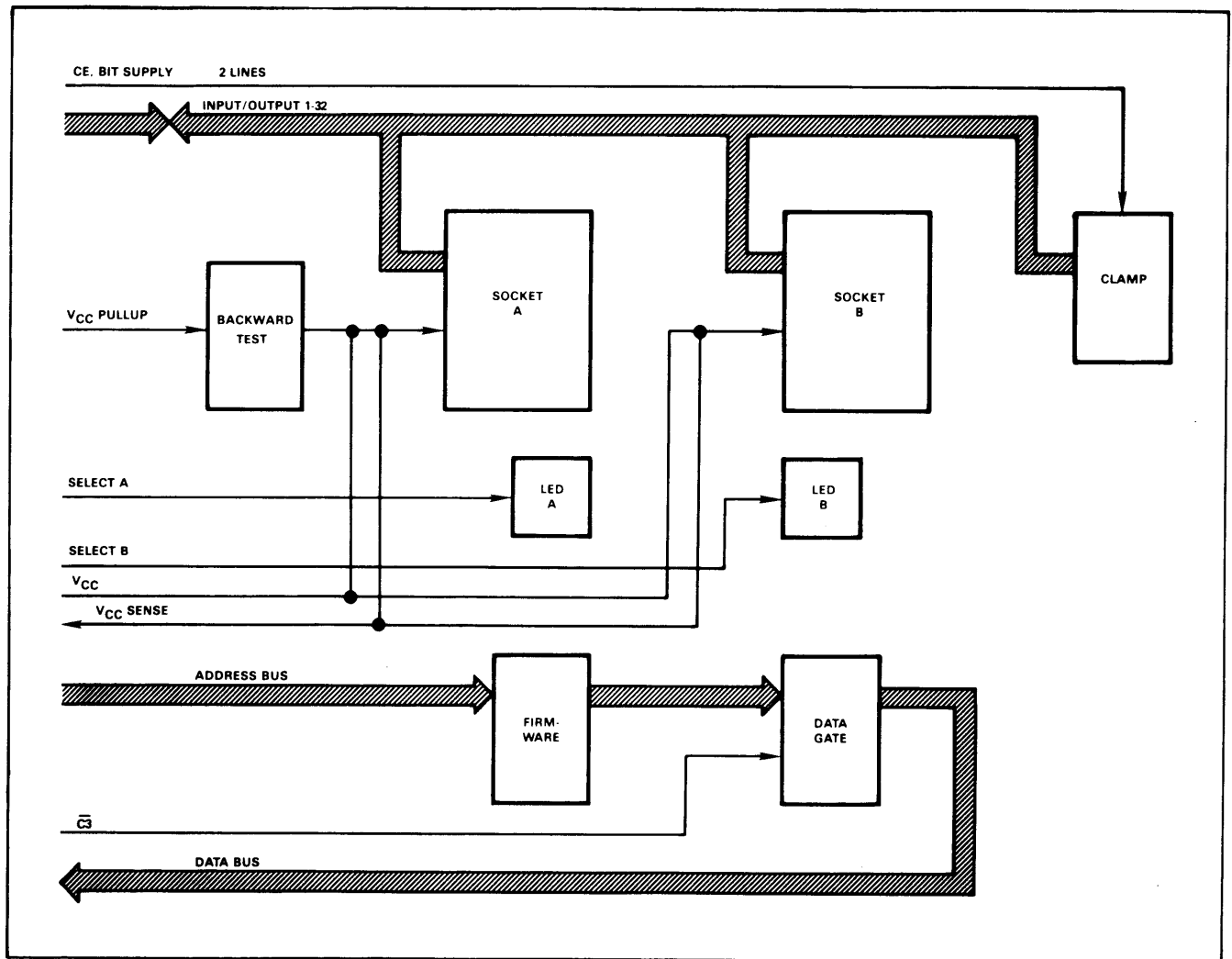

Figure 5-1. Typical Programming/Testing Adapter Block Diagram

**APPENDIX A
LOGIC DIAGRAMS
FAMILY AND PINOUT CODES**

Table A-1. AMD Device Support List

Device	Family Pinout	LogicPak™	P/T Adapter	Design Adapter
Advanced Micro Devices		DATA I/O Part Numbers		
AmPAL 16H8	97 25	VO1	303A-004	VO1 303A-100 VO3
AmPAL 16HD8	97 25	VO1	303A-004	VO1 303A-100 VO3
AmPAL 16L8	97 17	VO1	303A-004	VO1 303A-100 VO1
AmPAL 16LD8	97 17	VO1	303A-004	VO1 303A-100 VO3
AmPAL 16R4	97 24	VO1	303A-004	VO1 303A-100 VO1
	97 81	VO3 +	303A-004	VO2 303A-100 VO1
AmPAL 16R6	97 24	VO1	303A-004	VO1 303A-100 VO1
	97 80	VO3 +	303A-004	VO2 303A-100 VO1
AmPAL 16R8	97 24	VO1	303A-004	VO1 303A-100 VO1
	97 82	VO3 +	303A-004	VO2 303A-100 VO1
AmPAL 22V10	97 28 + +	VO3 +	303A-004	VO2 303A-100 VO3
	97 83 + + +	VO3 +	303A-004	VO2 303A-100 VO3

+ LogicPak revision VO4 required for full support of device register preload feature.
 + + Fingerprint™ treats pin 1 as a clock.
 + + + Fingerprint™ treats pin 1 as an input.

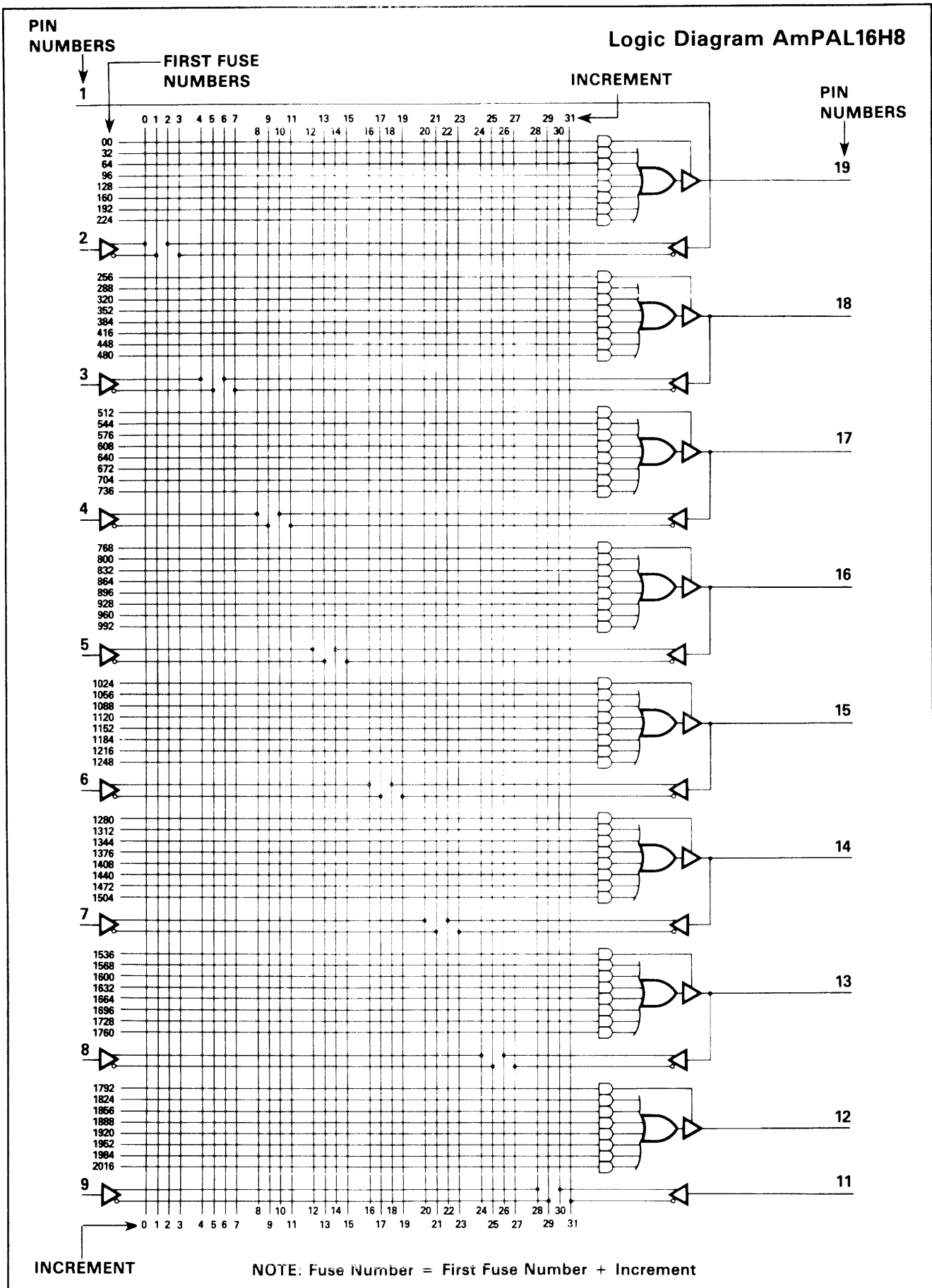

Figure A-1. AmpPAL16H8

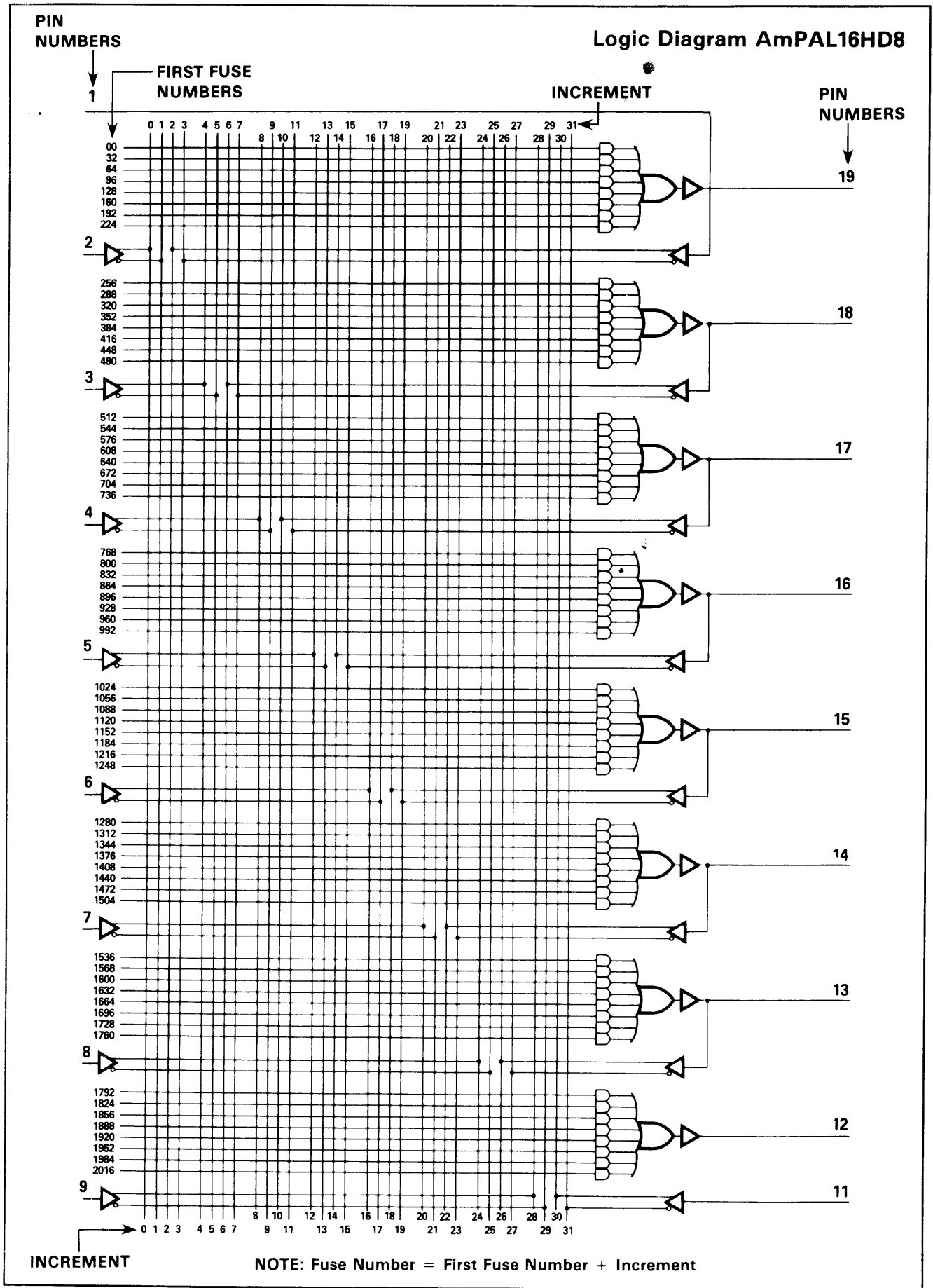
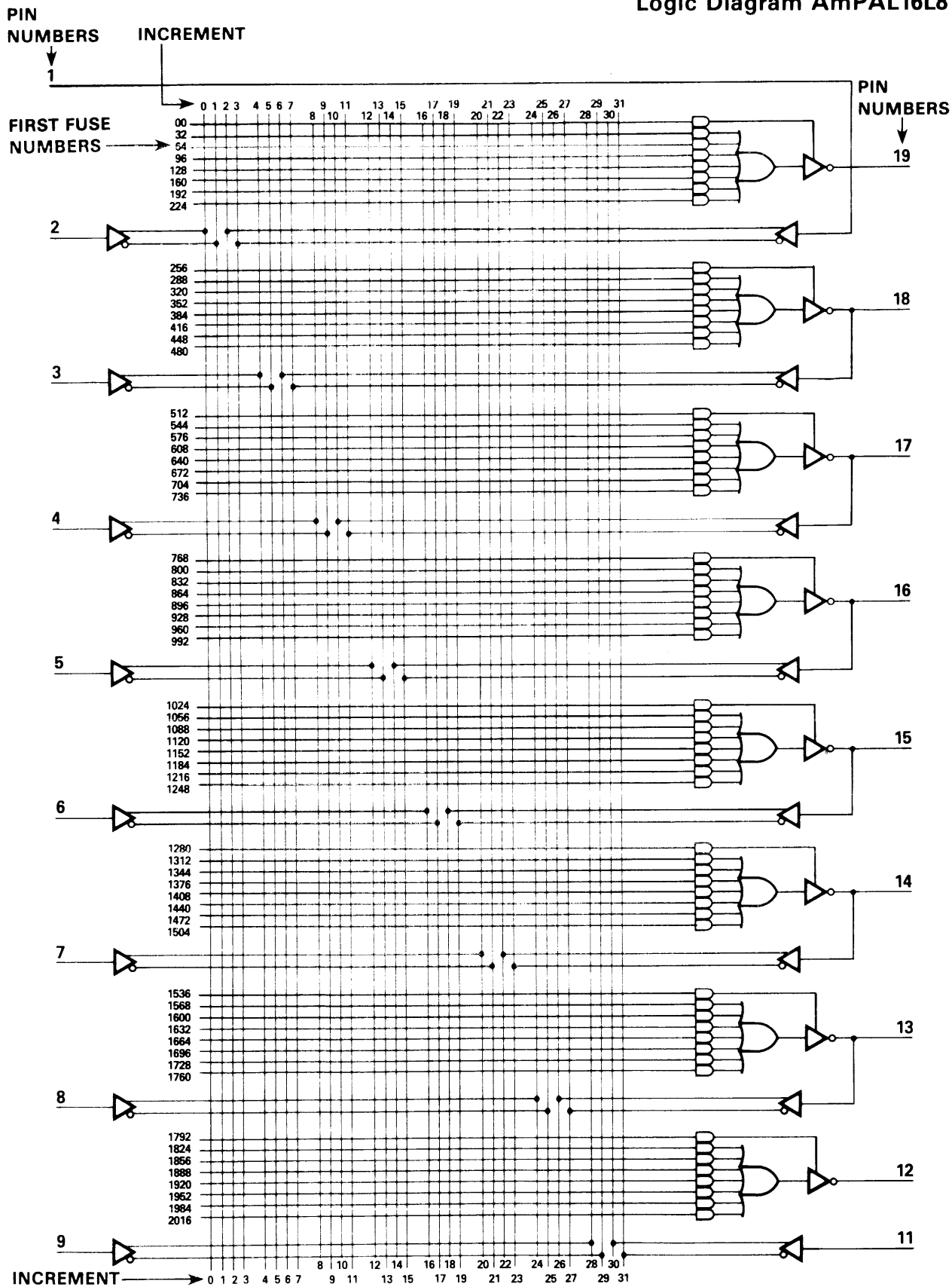

Figure A-2. Logic Diagram AmPAL16HD8

Logic Diagram AmPAL16L8



NOTE: Fuse Number = First Fuse Number + Increment

Figure A-3. Logic Diagram AmPAL16L8

PIN NUMBERS

Logic Diagram AmPAL16LD8

FIRST FUSE NUMBERS

INCREMENT

PIN NUMBERS

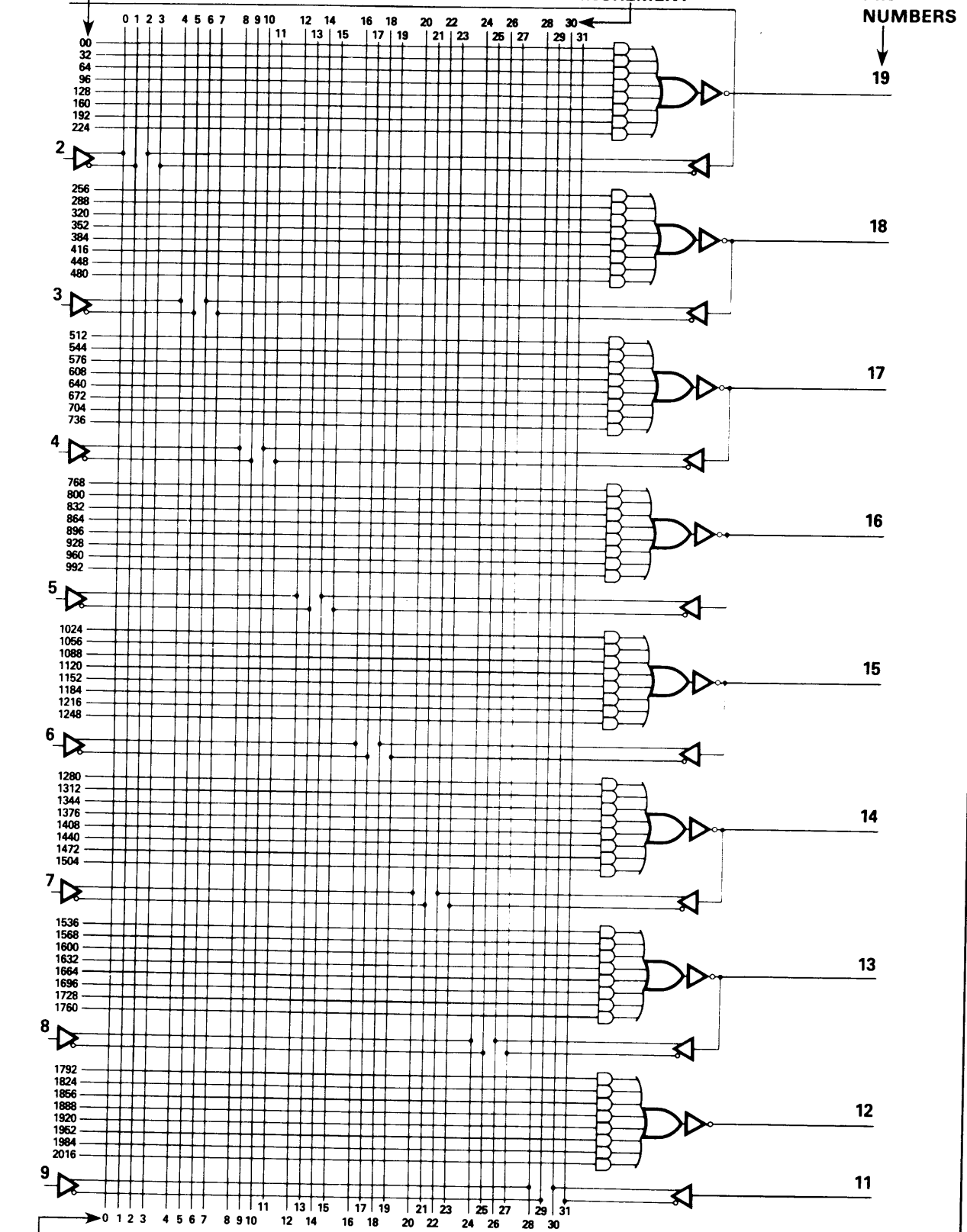

INCREMENT

NOTE: Fuse Number = First Fuse Number + Increment

Figure A-4. Logic Diagram AmPAL16LD8

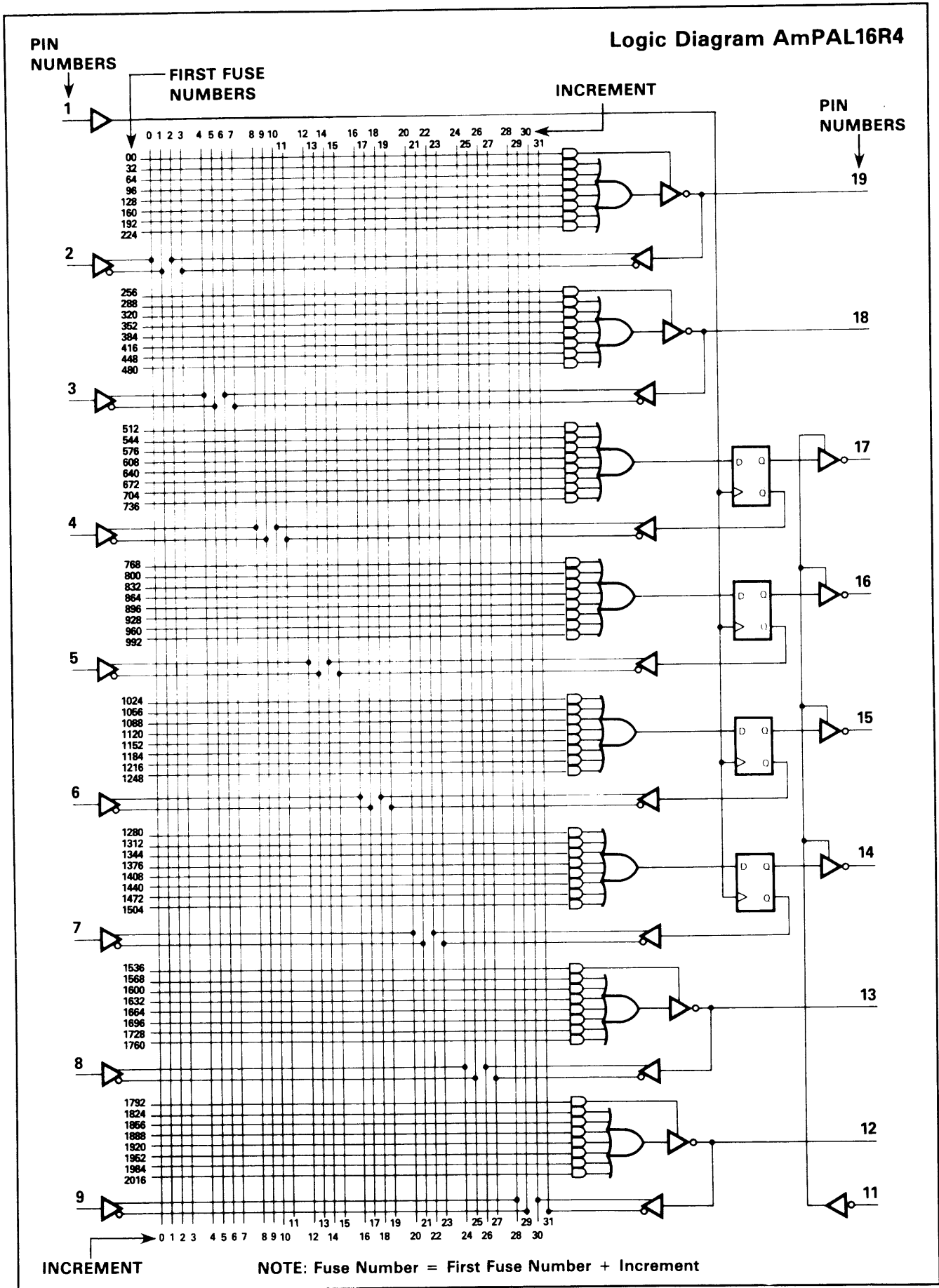

Figure A-5. AmPAL16R4

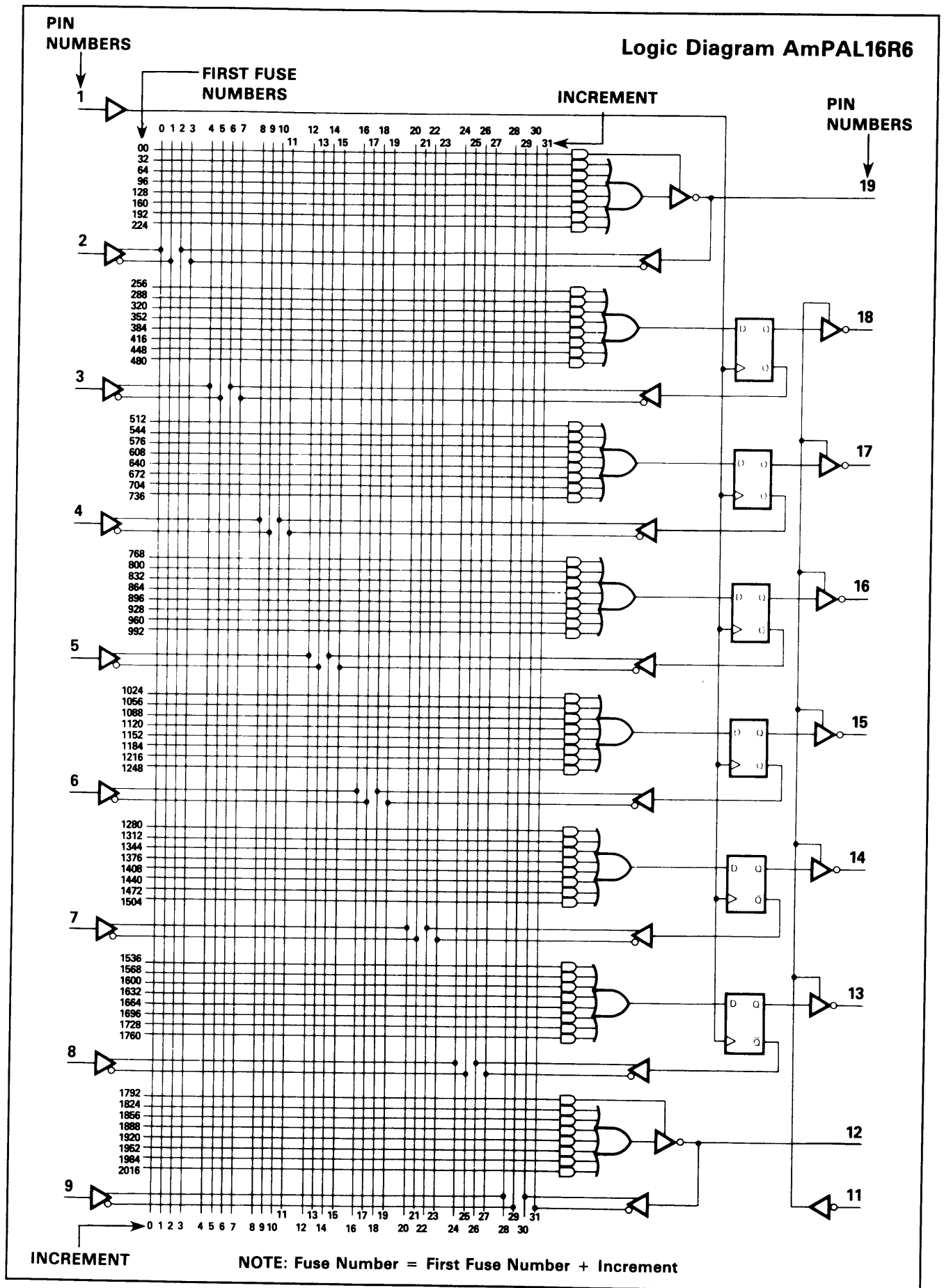
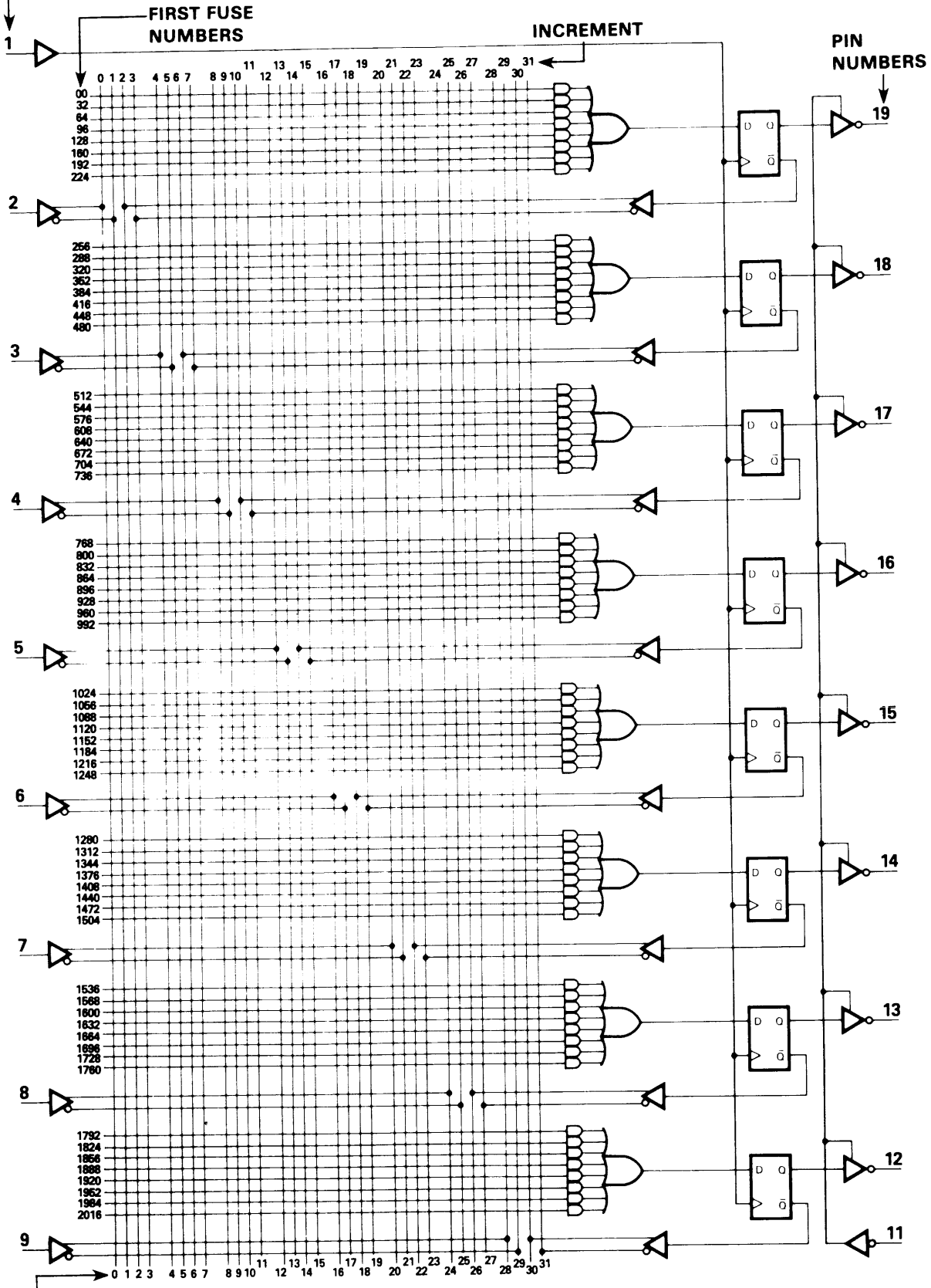

Figure A-6. Logic Diagram AmPAL16R6

PIN NUMBERS

Logic Diagram AmPAL16R8



INCREMENT

NOTE: Fuse Number = First Fuse Number + Increment

Figure A-7. AmPAL16R8

Logic Diagram AmPAL22V10

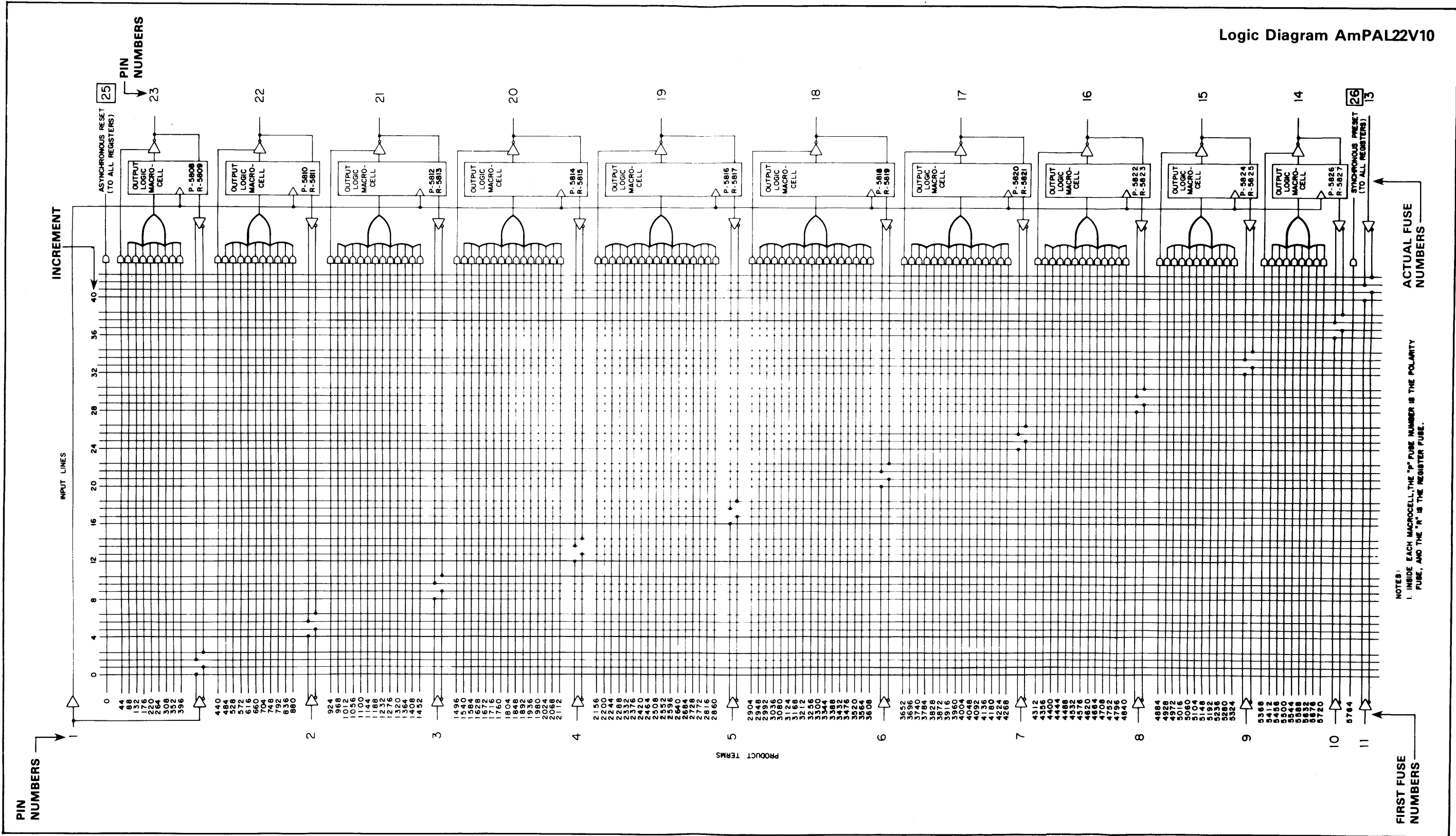

NOTES:
 1. INSIDE EACH MACROCELL, THE "P" FUSE NUMBER IS THE POLARITY FUSE, AND THE "R" IS THE REGISTER FUSE.

Figure A-8. Logic Diagram AmPAL22V10

APPENDIX B SCHEMATIC

30-702-1947-003 Programming/Testing Adapter

REVISIONS					
LTR	DESCRIPTION	DR	CHK	APPR'D	DATE
A	RELEASE	JK	7/2	GS	7/16/82
B	ECN 4684	CL	7/19	GS	7/27/82
C	ECN 4786	BV	7/27	GS	8/83

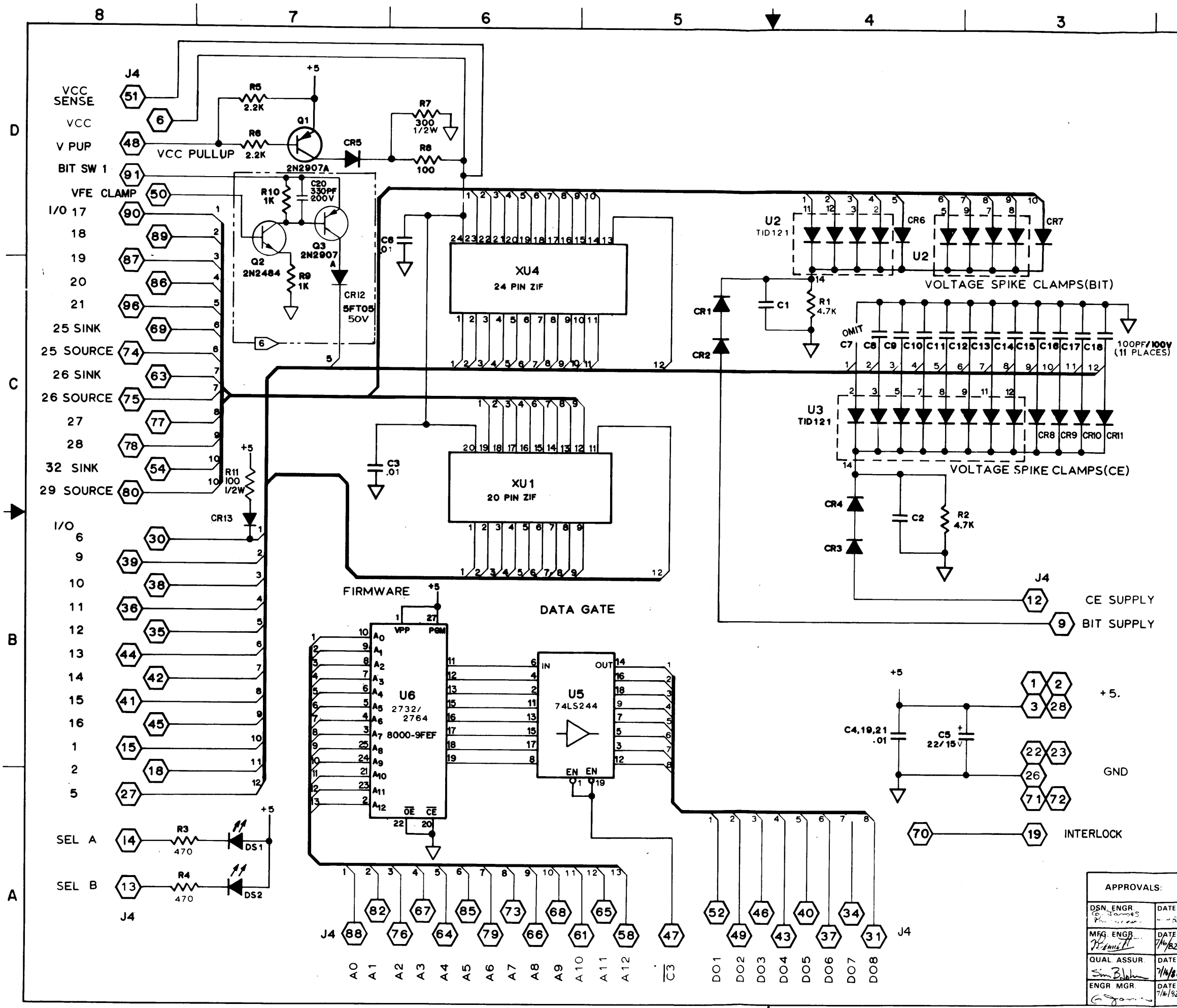

- NOTES: UNLESS OTHERWISE SPECIFIED
1. ALL RESISTORS ARE 1/4W AND IN OHMS, 5%.
 2. ALL CAPACITORS ARE IN MICROFARADS, .1, 50V.
 3. LAST REFERENCE DESIGNATOR USED:
U6, R11, DS2, CR13, C21, P4, Q3.
 4. ALL DIODES 1N4148

5. POWER & GROUND.

REF DES	+5	GND
XU4	-	12
XU1	-	10
U5	20	10
XU6	26, 28	14

6 REFER TO ASSY DWG. AND PARTS LIST FOR PARTS NOT INSTALLED FOR -002 CONFIGURATION

APPROVALS:		UNLESS OTHERWISE SPECIFIED DIMENSIONS ARE IN INCHES		TOLERANCES UNLESS OTHERWISE SPECIFIED		TITLE SCHEMATIC DIAGRAM, TEST PROG ADAPTER	
DSN ENGR	DATE	XX	XX	SERIES 20/24			
MFG ENGR	DATE	XXX	ANGULAR	DRAWING NO			
QUAL ASSUR.	DATE	DRAWN BY	DATE	SIZE	CODE	IDENT	DRAWING NO
ENGR MGR.	DATE	CHECKED BY	DATE	D	NO	54193	30-702-1947
				SCALE	NONE		SHEET 1 OF 1