

Publication Number 0117-0014-10

June 1984

K105-D LOGIC ANALYZER

USER'S MANUAL

Gould Inc., Design & Test Systems Division
4600 Old Ironsides Drive
Santa Clara, CA 95050-1279
Telephone: (408) 938-6800
TWX/TELEX # 910-338-0509

Copyright © 1984. No part
of this publication may be
reproduced without written
permission from Gould Inc.,
Design and Test Systems
Division. Printed in U.S.A.



K105-D Logic Analyzer with Disk Drive Option

WARNING

This equipment has not been tested to show compliance with new FCC Rules (47 CFR Part 15) designed to limit interference to radio and TV reception. Operation of this equipment in a residential area is likely to cause unacceptable interference to radio communication requiring the operator to take whatever steps are necessary to correct the interference.

The following procedures may help to alleviate the Radio or Television Interference Problems:

1. Reorient the antenna of the receiver receiving the interference.
2. Relocate the equipment causing the interference with respect to the receiver (move or change relative position).
3. Reconnect the equipment causing the interference into a different outlet so the receiver and the equipment are connected to different branch circuits.
4. Remove the equipment from the power source.

NOTE:

The user may find the following booklet prepared by the FCC helpful: "How to Identify and Resolve Radio-TV Interference Problems". This booklet is available from the U.S. Printing Office, Washington, D.C. 20402. Stock No. 004-000-00345-4.

PREFACE

This manual describes the capabilities, functions and operation of the K105-D Logic Analyzer. Procedures are provided for a user to record and examine both address and data of 8-bit and multiplexed 16-bit microprocessors.

A Glossary of Terms is included in Appendix A of this manual. The Glossary describes unique hardware and software terms associated with operation of the K105-D.

The material in this manual reflects the Control Firmware level valid on June 1, 1984, and is up-to-date at the time of publication, but is subject to change without notice.

Copies of this publication and other Gould Inc., Design and Test Systems Division Publications may be obtained from the Gould Inc., Design and Test Systems Division sales office or distributor serving your locality.

If you require assistance on this product, please call Gould Inc., Design and Test Systems Division Customer Service on the toll-free, hot-line number listed below:

Nationwide (800) 538-9320/9321

California (800) 662-9231

WARRANTY

The Gould Inc., Design and Test Systems Division K105-D is warranted against defects in materials and workmanship for a period of one year from date of shipment. Any floppy disk or hard disk drives attached to or contained within this equipment are warranted for 90 days from date of shipment. Gould Inc., Design and Test Systems Division will repair or replace products that prove to be defective during the warranty period.

Warranty service must be performed at a Gould Inc., Design and Test Systems Division authorized service facility. **The customer must call Gould's Customer Service department at the toll-free numbers listed in the front of this manual and obtain a Return Authorization number prior to returning the unit for service.** If a unit fails within 30 days of shipment date, Gould Inc. will pay all shipping charges relating to the repair of the unit. Units under warranty, but beyond the 30 day period should be sent to Gould Inc. prepaid, and Gould Inc. will return the unit prepaid. The customer must pay all shipping charges for units out of warranty.

Misuse of, abuse of or tampering with this unit will, at the discretion of Gould Incorporated, cause this warranty to be null and void.

CONTENTS

Chapter		Page
1	INTRODUCTION	
	GENERAL DESCRIPTION	1-1
	FEATURES AND APPLICABILITY	1-1
	Software Control	1-1
	External Interface	1-3
	Reconfigurable Hardware and Software	1-3
	Trace Control	1-4
	Dynamic Threshold Range	1-4
	Tolerance Comparison Analysis	1-4
	K105-D HARDWARE CONFIGURATION	1-4
	Threshold and Clock Board	1-5
	MPU Board	1-6
	Display Board	1-6
	Data Board	1-6
	Trace Control Board	1-6
	High-Speed Board	1-7
	I/O Board	1-7
2	SPECIFICATIONS	
	GENERAL	2-1
	POWER REQUIREMENTS	2-1
	PHYSICAL DIMENSIONS AND WEIGHT	2-1
	ENVIRONMENTAL LIMITS	2-1
	PROBE INPUTS	2-2
	MAIN INPUTS	2-2
	HIGH SPEED INPUTS	2-2
	MAIN CLOCKS	2-3
	HIGH SPEED CLOCKS	2-3
	SIGNAL OUTPUTS	2-3
	SETUP AND HOLD	2-3
	TRACE MEMORY	2-4
	INTERFACE	2-4
	UNPACKING AND INSPECTION	2-4
3	PHYSICAL DESCRIPTIONS	
	GENERAL	3-1
	K105-D FRONT PANEL CONNECTORS AND SWITCHES	3-1
	Display	3-2
	AC Power ON/OFF and Power Indicator	3-2
	Front Panel Connectors	3-2
	Keypanel	3-4
	REAR PANEL CONNECTORS AND SWITCHES	3-12
	Interface Group	3-12
	Power Input Group	3-14
	Signal Output Group	3-14

CONTENTS (Cont'd.)

Chapter		Page
4	OPERATION	
	GENERAL	4-1
	USER AIDS	4-1
	ORGANIZATION OF DISPLAYS	4-2
	GETTING STARTED	4-4
	COMMON DISPLAY ELEMENTS	4-6
	COMMON KEY FUNCTIONS.	4-8
	ARM/ADV Key	4-12
	STOP/W/XFER Key	4-13
	FORMAT SET UP SCREEN.	4-14
	Probes.	4-14
	Data Format Field	4-16
	Level Number Field.	4-16
	Section Line and Inputs Fields.	4-16
	Threshold Fields.	4-18
	Polarity Fields	4-18
	CLOCKS SET UP SCREEN.	4-19
	Clock Source Field.	4-19
	Master Clock Time Interval and Time Unit Fields	4-20
	Master Clock Source Field	4-20
	External Clock Combination Definitions Clock Inputs Field.	4-22
	External Clock Combination Definitions Name	4-22
	Sample/Demux Field.	4-22
	TRACE CONTROL SET UP SCREEN	4-25
	General	4-25
	Set Up Trace.	4-26
	Trace Control Command Descriptions.	4-27
	Command Sequence Restrictions	4-30
	Pattern Definitions	4-30
	TRACE CONTROL PARAMETER SETUP REVIEW SCREEN	4-32
	ARM MODE SET UP SCREEN.	4-34
	Arm Mode : Field.	4-35
	Auto Flush Field.	4-35
	Arm Inputs = Field.	4-35
	Pass Counter.	4-35
	Auto Compare Field.	4-36
	Condition Statement Field	4-36
	AUTO COMPARE SET UP SCREEN.	4-37
	Main Inputs Comparison Fields	4-37
	Main Inputs Selection Fields.	4-38
	High-Speed Inputs Compare Set Up.	4-38
	Auto Edge Tolerance Fields.	4-38
	HIGH SPEED SET UP SCREEN.	4-39
	Sequence Fields	4-40
	Link Field.	4-40
	Trigger Word Field.	4-41
	Trigger Field	4-41
	Filter Field	4-41

CONTENTS (Cont'd.)

Chapter		Page
4	OPERATION (cont'd)	
	HIGH SPEED SET UP SCREEN (cont'd)	
	Delay Value Field	4-41
	Delay Mode Field.	4-41
	Clock Source Field.	4-41
	Clock Interval and Clock Decade Fields.	4-42
	Clock Fields.	4-42
	Input Mode Field.	4-43
	Thresholds and Polarity Fields.	4-43
	Polarity Fields	4-43
	DATA DISPLAY SCREEN	4-44
	Data Display Screen - Edit Mode	4-45
	TIMING DISPLAY SCREEN	4-48
	Timing Display Screen - Edit Mode	4-50
	GRAPH DISPLAY SCREEN.	4-51
	MAIN PERFORMANCE ANALYSIS SCREEN.	4-53
	NOISE MARGIN ANALYSIS	4-54
	Noise Margin Analysis Preparation	4-54
	Noise Margin Analysis Setup	4-55
	Interpreting Analysis Data.	4-56
	PERCENT VERSUS TIME HISTOGRAM DISPLAY SCREEN.	4-58
	Performance Analysis Level Field.	4-58
	I/O FUNCTION MENU	4-59
	I/O SETUP SCREEN.	4-61
	Mode = Field.	4-62
	GPIB Address = Field.	4-62
	Terminator = Field.	4-62
	EOI Output = Field.	4-62
	Baud Rate = Field	4-62
	Word Length = Field	4-62
	Stop Bit(s) = Field	4-62
	Parity = Field.	4-63
	Protocol = Field.	4-63
	I/O Port = Field.	4-63
	Record Length = Field	4-63
	Command = Field	4-63
	INTERFACE	4-65
	GPIB.	4-65
	RS-232-C.	4-65
	GPIB INTERFACE DESCRIPTION.	4-66
	GPIB INTERFACE CONNECTION	4-66
	INTERFACE MODE.	4-67
	Talk and Listen Mode.	4-67
	IFC Command	4-67
	Device Trigger and Device Clear Commands.	4-67
	Talk Only Mode.	4-67
	Listen Only Mode.	4-68

CONTENTS (Cont'd.)

Chapter		Page
4	OPERATION (cont'd)	
	TERMINATION CHARACTERS	4-68
	GPIB STATUS BYTE	4-68
	RS-232-C	4-69
	PROTOCOLS.	4-69
	RS-232-C INTERFACE CONNECTION.	4-69
	The Null Modem	4-69
	Example Use of Printer for Graphics Printout	4-72
	INTERFACING TWO K105-D's	4-72
5	INPUT/OUTPUT OPERATIONS	
	GENERAL.	5-1
	RECORD TYPES	5-1
	Send All Record Types.	5-2
	CONVENTIONS FOR COMMAND SYNTAX	5-2
	Command Categories	5-2
	INVALID RECORDS.	5-2
	RS-232	5-2
	GPIB	5-3
	RANGE SPECIFICATIONS	5-3
	INDEX BY COMMAND	5-6
	CLOCK DEMUX (CD)	5-11
	CLOCK EXPRESSIONS (CX)	5-12
	CLOCK SECTIONS (CS)	5-13
	CLOCK SETUP (CC)	5-14
	SEND ALL CLOCK SETUP RECORDS (C-).	5-15
	FORMAT DATA (FD)	5-16
	FORMAT FORMAT (FF)	5-17
	FORMAT LEVEL (FL)	5-18
	FORMAT POLARITY (FP)	5-19
	FORMAT THRESHOLD (FT)	5-20
	FORMAT VAR VOLTAGE (FV)	5-21
	SEND ALL FORMAT SETUP RECORDS (F-)	5-22
	TRACE CONTROL COMMAND (TC)	5-23
	TRACE CONTROL PARAMETER FIELD (TP)	5-27
	TRACE CONTROL PATTERN NAME (TN)	5-28
	TRACE CONTROL PATTERN VALUE FIELD (TV)	5-29
	SEND ALL TRACE CONTROL SETUP RECORDS (T-).	5-30
	ARM MODE INPUT FIELD (RI)	5-31
	ARM MODE AUTO FLUSH (RA)	5-32
	ARM MODE CONDITION FUNCTION (RC)	5-33
	ARM MODE MODE FIELD (RM)	5-34
	ARM MODE PASS COUNTER (RP)	5-35
	SEND ALL ARM MODE SETUP RECORDS (R-)	5-36
	AUTO COMPARE, HIGH SPEED CHANNEL SELECT (WZ)	5-37
	AUTO COMPARE, HIGH SPEED EDGE TOLERANCE (WE)	5-38
	AUTO COMPARE, HIGH SPEED LENGTH (WL)	5-39
	AUTO COMPARE, HIGH SPEED SELECT (WS)	5-40
	AUTO COMPARE, HIGH SPEED START A (WA)	5-41
	AUTO COMPARE, HIGH SPEED START B (WB)	5-42

CONTENTS (Cont'd.)

Chapter		Page
5	INPUT/OUTPUT OPERATIONS (cont'd)	
	AUTO COMPARE, MAIN CHANNEL SELECT (UZ)	5-43
	AUTO COMPARE, MAIN EDGE TOLERANCE (UE)	5-44
	AUTO COMPARE, MAIN LENGTH (UL)	5-45
	AUTO COMPARE, MAIN SELECT (US)	5-46
	AUTO COMPARE, MAIN START A (UA)	5-47
	AUTO COMPARE, MAIN START B (UB)	5-48
	SEND ALL AUTO COMPARE SETUP RECORDS (U-)	5-49
	NOISE MARGIN ANALYSIS, HIGH SPEED BEGINNING THRESHOLD (NC)	5-50
	NOISE MARGIN ANALYSIS, HIGH SPEED ENDING THRESHOLD (ND)	5-51
	NOISE MARGIN ANALYSIS, MAIN BEGINNING THRESHOLD (NB)	5-52
	NOISE MARGIN ANALYSIS, MAIN ENDING THRESHOLD (NE)	5-53
	NOISE MARGIN ANALYSIS, MAIN SELECT (NS)	5-54
	SEND ALL NOISE MARGIN ANALYSIS SETUP RECORDS (N-)	5-55
	HIGH SPEED CLOCK SETUP (SC)	5-56
	HIGH SPEED DELAY (SD)	5-57
	HIGH SPEED FILTER (SF)	5-58
	HIGH SPEED INPUT MODE (SI)	5-59
	HIGH SPEED LINK (SL)	5-60
	HIGH SPEED POLARITY (SP)	5-61
	HIGH SPEED SEQUENCE (SS)	5-62
	HIGH SPEED THRESHOLD (ST)	5-63
	HIGH SPEED TRIGGER (SX)	5-64
	HIGH SPEED TRIGGER POLARITY (SG)	5-65
	SEND ALL HIGH SPEED SETUP RECORDS (S-)	5-66
	MAIN CHANNEL CONTROL POSITION (MC)	5-67
	MAIN CHANNEL DATA (MA/MB/MX)	5-68
	MAIN CHANNEL GRAPH EXPANSION (MG)	5-69
	MAIN CHANNEL LEVEL DATA (LA/LB)	5-70
	MAIN CHANNEL REFERENCE POSITION (MR)	5-71
	MAIN CHANNEL SEARCH LEVEL (MV)	5-72
	MAIN CHANNEL SEARCH VALUE (MS)	5-73
	MAIN CHANNEL TIMING EXPANSION (MT)	5-74
	MAIN CHANNEL TIMING LABELS (ML)	5-75
	MAIN CHANNEL TIMING SEQUENCE (MQ)	5-76
	SEND ALL MAIN CHANNEL DATA RECORDS (M-)	5-77
	HIGH SPEED CONTROL POSITION (HC)	5-78
	HIGH SPEED DATA (HA/HB/HX)	5-79
	HIGH SPEED GRAPH EXPANSION (HG)	5-80
	HIGH SPEED TIMING EXPANSION (HT)	5-81
	HIGH SPEED TIMING LABEL (HL)	5-82
	HIGH SPEED REFERENCE POSITION (HR)	5-83
	HIGH SPEED TIMING SEQUENCE (HQ)	5-84
	HIGH SPEED SEARCH VALUE (HS)	5-85
	SEND ALL HIGH SPEED DATA RECORDS (H-)	5-86
	SEARCH/COMPARE (ZC)	5-87
	SEARCH FIRST (ZF)	5-88
	SEARCH LAST (ZL)	5-89
	SEARCH RESULTS ARRAY (ZR)	5-90
	SEARCH TOTAL (ZT)	5-91

CONTENTS (Cont'd.)

Chapter		Page
5	INPUT/OUTPUT OPERATIONS (cont'd)	
	SEND ALL SEARCH DATA RECORDS (Z-)	5-92
	ACQUISITION CONTROL (QQ)	5-93
	CLEAR DISPLAY (DC)	5-94
	DEVICE CLEAR (KK)	5-95
	DISPLAY SCREEN (DS)	5-96
	DISPLAY TEXT ON CRT (DT)	5-97
	K105-D CONFIGURATION (KC)	5-98
	K105-D STATUS (KT)	5-99
	KEYSTROKES (\$+ or \$-)	5-101
	MAIN/HIGH SPEED SELECT (MH)	5-102
	PRINT SCREEN DIRECT (PD)	5-103
	PRINT SCREEN LONG (PL)	5-104
	PRINT GRAPHICS (PG)	5-105
	TRANSFER SETUP MEMORIES BETWEEN M, A OR B (TR)	5-106
	HISTOGRAM LEVEL SELECTION (XL)	5-107
	SEND ALL SETUP RECORDS (--)	5-108
6	AN ILLUSTRATIVE TRACE RECORDING	
	GENERAL	6-1
	RECORDING PREPARATION	6-1
7	OPTIONS INSTALLATION	
	GENERAL	7-1
	CARD CAGE ARRANGEMENT	7-2
	INSTALLATION OF HIGH SPEED LOWER BITS OPTION	7-3
	Unpacking and Inspection	7-3
	Installation	7-4
	Removal of DOS Option Assembly	7-5
	INSTALLATION OF HIGH SPEED UPPER BITS OPTION	7-7
	Unpacking and Inspection	7-7
	Installation	7-7
	Removal of DOS Option Assembly	7-9
	INSTALLATION OF 32 MAIN INPUT LOWER BITS OPTION	7-12
	Unpacking and Inspection	7-12
	Installation	7-12
	Removal of DOS Option Assembly	7-13
	INSTALLATION OF 32 MAIN INPUT UPPER BITS OPTION	7-16
	Unpacking and Inspection	7-16
	Installation	7-16
	Removal of DOS Option Assembly	7-18
	INSTALLATION OF DOS OPTION	7-20
	Unpacking and Inspection	7-20
	Installation	7-20

CONTENTS (Cont'd.)

Appendices

A	GLOSSARY OF TERMS	A-1
B	TRACE TUTORIAL	B-1

Figures

		Page
1-1	K105-D Logic Analyzer User Controls and Indicators	1-2
1-2	K105-D Simplified Block Diagram	1-5
3-1	K105-D Front Panel	3-1
3-2	K105-D Arrangement of Input Connections	3-3
3-3	Screen Setup and Display Key Group	3-5
3-4	Control and Reference Key Group	3-6
3-5	Cursor Control Key Group	3-7
3-6	Edit Key Group	3-8
3-7	Record Key Group	3-9
3-8	Data Entry Key JGroup	3-10
3-9	Special Purpose Key Group	3-11
3-10	K105-D Rear Panel	3-13
4-1	Organization of Displays	4-3
4-2	Display Options Screen	4-6
4-3	Typical Screen Display	4-8
4-4	First Level Help Message	4-10
4-5	Second Level Help Screen	4-11
4-6	Typical K105-D Probe	4-14
4-7	Set Up Main Format Screen	4-15
4-8	Clocks Set Up Screen with Internal Clock Source	4-19
4-9	Clocks Set Up Screen with External Clock Source	4-21
4-10	Clocks Set Up Screen with External Multi-Phased Clock Source	4-23
4-11	Trace Control Set Up Screen	4-25
4-12	Trace Control Parameter Setup Review Screen	4-32
4-13	Arm Mode Set Up Screen with Auto Arm Mode Selected	4-34
4-14	Auto Compare Set Up Screen	4-37
4-15	Set Up High Speed Screen	4-39
4-16	Data Display Screen	4-44
4-17	Data Display Screen in Edit Mode	4-46
4-18	Main Inputs Timing Display Screen	4-48
4-19	Graph Display Screen	4-51
4-20	Main Performance Analysis Screen	4-53
4-21	Display Main Analysis Screen	4-55
4-22	Time Interval Histogram Display Screen	4-58
4-23	I/O Function Menu	4-60
4-24	I/O Setup Screen	4-61
4-25	Component Side of Data Display Board	4-64
4-26	Simple Null Modem Wiring Diagram	4-70
4-27	Null Modem Wiring Diagram with DTR/DSR	4-70
4-28	Complete Null Modem	4-71
4-29	Null Modem for Epson Printer	4-71

CONTENTS (Cont'd.)

Figures		Page
6-1	8088 Basic System Timing	6-2
6-2	Clock Set Up Screen for 8088 Recording	6-3
6-3	8088 Pin Connections	6-4
6-4	8088 Program Listing	6-5
6-5	Format Set Up Screen	6-6
6-6	Trace Set Up Screen	6-7
6-7	Arm Mode Set Up Screen	6-8
6-8	Traced Data	6-9
6-9	Searched Data	6-10
7-1	K105-D Card Cage Arrangement	7-2
7-2	Ribbon Cable Connections, High Speed Input Lower Bits Option	7-5
7-3	Ribbon Cable Connections, High Speed Input Upper Bits Option	7-10
7-4	32 Main Input Lower Bits Option, Ribbon Cable Connections	7-13
7-5	32 Main Input Upper Bits Option, Ribbon Cable Connections	7-18
7-6	Disk Drive Ribbon Cable Connection to I/O Board	7-22
7-7	Disk Drive Power Harness Connections	7-22
7-8	Top View of DOS Unit with Top Cover Removed	7-23
Tables		Page
3-1	K105-D I/O IEEE-488 Connector Pin-Descriptions	3-12
3-2	K105-D RS-232C Port Pin Descriptions	3-13
4-1	Radix Definitions	4-17
4-2	Trace Control Command Format	4-29
4-3	GPiB Interface Capabilities	4-66
5-1	Trace Control Command Entries	5-23
7-1	High Speed Lower Bits Option Components	7-3
7-2	High Speed Upper Bits Option Components	7-7
7-3	32 Input Lower Bits Option Components	7-12
7-4	32 Input Upper Bits Option Components	7-16
7-5	DOS Option Components	7-20

INTRODUCTION

GENERAL DESCRIPTION

The Gould Model K105-D Logic Analyzer (Figure 1-1) is a precision, high-performance test and development instrument that monitors input logic signals generated by the user's external microprocessor-based equipment. The K105-D accepts data inputs from 32 (or optional 64) Main Input channels and 8 (or optional 16) High-Speed Input channels. The Main data inputs are driven by 8 external clocks; High-Speed data inputs are driven by 2 external clocks. All inputs are applied via pod/probe circuits that interface to the user's equipment.

A versatile clock scheme and a variety of data input options allow the user to easily and rapidly examine and record both addresses and data of very fast, 8-bit and 16-bit microprocessors.

FEATURES AND APPLICABILITY

Software Control

The K105-D internal control logic performs measurements on the input signals to correlate data/timing characteristics, accomplish comparison analysis, capture of data samples and recording the results in memory. The measurements operations are menu-driven by resident firmware which is controlled by manipulating various keys on the keyboard panel. The menu displays allow the user to setup test conditions, capture the results for binary logic states via trace for data-domain analysis and collect pulse-train waveforms for time-domain analysis. The display screen presents the results of analysis for examination and/or modification by the user.

The user-friendly control firmware generates the display menus for selecting acquisition parameters and allows direct control over the acquisition process; furthermore, the control firmware displays and interprets the acquired data, and informs the user of current system status. Because the control firmware of the K105-D is simple to use and yet versatile, the instrument is suitable for a variety of uses including field service testing and laboratory software and hardware development.

The K105-D offers the user a menu-guided Trace Control* that is simple to use, and powerful. Trace levels can be rapidly set up using the menus and front panel keys. The flexibility of trace control is enhanced by a selection of qualifiers that allow the user to pick and choose the information he wishes to record.

Data may be displayed in hexadecimal, octal or binary format, or the user may elect to display the data in up to 40 columns in any radix (user specified format).

*Gould Inc., Trademark pending

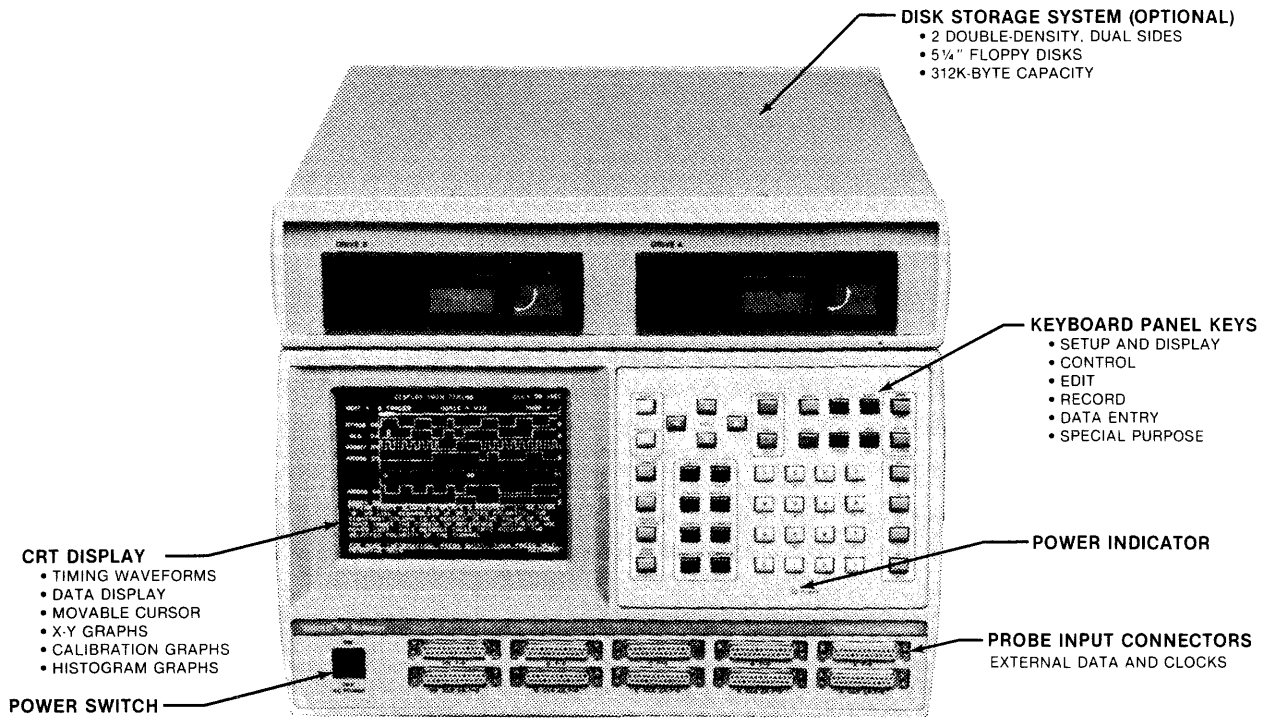

Figure 1-1. K105-D Logic Analyzer User Controls and Indicators

External Interface

The K105-D may be interfaced to the user's CPU system via rear panel connectors that provide GPIB and RS-232C communications linkage. The I/O setup screen allows the user to set up parameters and initiate execution of the transfer operation.

The GPIB interface allows I/O transfer of parallel data and commands between the K105-D and the user's CPU. The communications parameters are programmable by the user to setup the following communication modes for the GPIB link:

- Talk Only Mode - Transmit data and commands to CPU
- Listen Only Mode - Receive data and commands from CPU
- Talk and Listen Mode - Perform interactive two-way dialogue between the K105-D and CPU to transmit and receive information

An RS-232 interface allows I/O transfer of serial data and commands between the K105-D and the user's devices, such as, printer, personal computer, terminal, etc. The setup screen allows the user to specify conditions, such as, baud rate, protocol, word length, etc., that are used to control the transfer.

Reconfigurable Hardware and Software

The user can purchase a K105-D unit in a minimum configuration such as 32 main inputs rated at 20 MHz. At some later date, the unit can be modified at the user's site to meet increased demands by adding high-speed inputs rated at 100 MHz. The following data input arrangements are supported:

HIGH SPEED INPUTS ONLY:

- 8 High Speed Inputs @ 100 MHz (Bits 0-7 @ Section HS)
- (OR)
- 16 High Speed Inputs @ 100 MHz (Bits 0-F @ Section HS)

MAIN INPUTS ONLY:

- 32 Main Inputs @ 20 MHz (Bits 0-7 @ Sections A, B, C, and D)
- (OR)
- 64 Main Inputs @ 20 MHz (Bits 0-F @ Sections A, B, C, and D)

COMBINED MAIN AND HIGH SPEED INPUTS:

- 64 Main Inputs and 8 High Speed Inputs (Bits 0-F @ Sections A, B, C, D and Bits 0-7 @ Section HS)
- (OR)
- 32 Main Inputs and 8 High Speed Inputs (Bits 0-7 @ Sections A, B, C, D and Bits 0-7 @ Section HS)
- (OR)
- 32 Main Inputs and 16 High Speed Inputs (Bits 0-7 @ Sections A, B, C, D and Bits 0-F @ Section HS)

The user may also include the Disk Operating System (DOS) Option which contains a dual, 5-1/4" disk drive system that provides the following capabilities:

- Save analysis setup conditions on the disk and restore at a later time
- Save acquired data for later retrieval
- Load Diagnostic Software for troubleshooting K105-D equipment operation
- Load Optional Disassemblers that convert binary information for microprocessor instructions and data into a mnemonic format.

Trace Control

The trace control functions of the K105-D are menu driven and are programmable in an English-like language. Eight levels of trace prerequisites are available, each of which can be programmed to selectively trace, advance to the next level, jump to any level or stop the recording based on a match or non-match of four independent patterns and the status of the delay counter. In conjunction with delay, this control scheme permits the user to locate, store and display several specific subroutines within a large program.

Dynamic Threshold Range

The K105-D enables the user to automatically determine the threshold ranges of devices in a unit under test (UUT) during actual operation. The information gathered in this test provides the user with an insight to the noise margins of the unit under test.

Tolerance Comparison Analysis

The K105-D contains a memory that allows the user to enter don't-care states in the data, timing, and arm mode displays. When the compare function is enabled, comparisons are not made in those areas designated as don't-care; consequently, the user is able to obtain more reliable results during automatic testing.

K105-D HARDWARE CONFIGURATION

Figure 1-2 is a simplified block diagram illustrating the major subassemblies of the K105-D. These subassemblies consist of printed circuit boards that interact with the Master Processor Unit (MPU) board to control K105-D circuit functions. The following printed circuit board functions are described in subsequent paragraphs:

- Threshold and Clock Board
- MPU Board
- Display Board
- Data Board
- Trace Control Board
- High Speed Board
- I/O Board

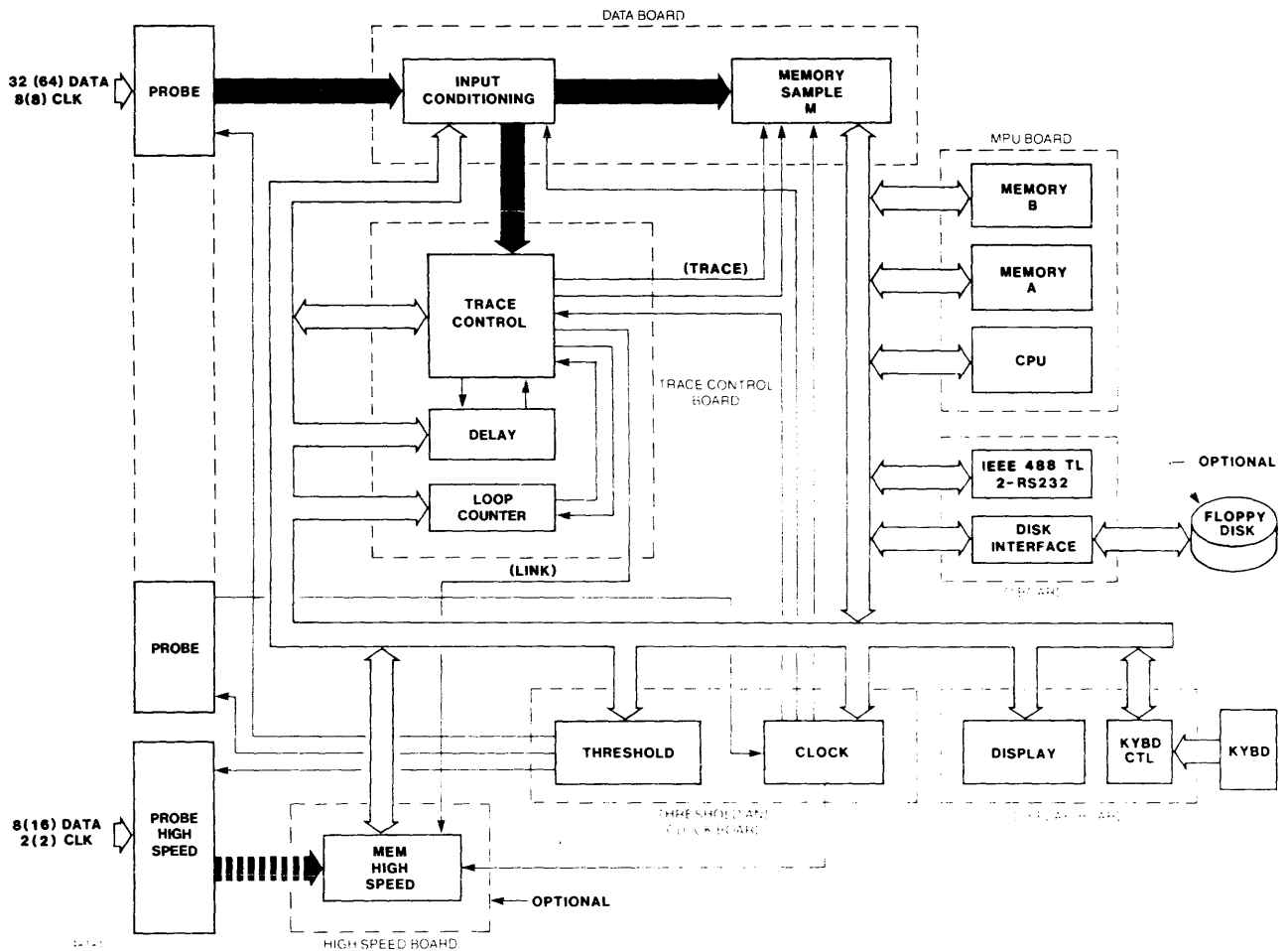

Figure 1-2. K105-D Simplified Block Diagram

Threshold and Clock Board

The Threshold and Clock board provides the fixed and variable threshold voltages for the probe pods. This board processes the external clocks from the probes and supplies the clocks for input memory, demultiplexing and trace control functions. In addition, this board can supply a range of internal clocks in a 1, 2, 5 sequence starting at 50ms (20Hz) and going to 50ns (20MHz). The internal clocks for the High Speed board range from 50ms (20Hz) to 10ns (100MHz) in a 1, 2, 5 sequence. This board also contains an Analog-to-Digital Converter used to read power supply voltage levels during power-up diagnostics.

MPU Board

The MPU board contains memories A and B, an 8086 CPU and the display firmware. This board provides control functions for the following:

- Display
- Display Setups
- Memory Transfers
- Keyboard
- Memory Functions
- Memory Compares

Display Board

The Display board contains the keyboard scanning circuitry and the CRT scanning and high voltage drive circuitry for the bit mapped display.

Data Board

The Data board processes 32 main inputs (via one board) or 64 main inputs (via two boards). The Data board provides interface from the ECL devices of the probe pods to the TTL devices within the Data board. In addition to sample mode input of data, this board provides demultiplexing of data by byte. For those units equipped with two Data boards (64 main inputs), the data may be demultiplexed by byte or word, and the demultiplexed inputs can be split between inputs, bytes or words.

The Data board memory is 1K bits deep by 32 bits wide and gathers data at 20 MHz. Data is stored in memory on instruction from trace control.

Trace Control Board

The Trace Control board contains a high-speed memory that is used to enable the board to recognize commands (JUMP, ADVANCE, TRACE and STOP). Also present on this board is an eight-state control counter used for control of the JUMP and ADVANCE commands, and high-speed memory for control of internal functions, such as delay.

The delay function on this board contains an independent counter that advances on each clock pulse or ADVANCE command. This counter resets on each level change, including a jump to the same level. Any or all command parameters may be modified to function only if the parameter occurs when the counter is less than (<), equal to (=), greater than (>), less than or equal to (<=), greater than or equal to (>=), or not equal to (≠) the full count. If the full count = 1, a delay of <1 is illegal.

The Trace Control board also contains a loop counter that increments each time a programmed level is entered. This counter may be programmed for counts of from one to 4095 counts, and when the programmed count is attained, an unconditional and undelayed STOP occurs.

The Trace Control board also provides a signal (Link) to enable the High-Speed board or to trigger an external apparatus.

High-Speed Board

The High Speed board processes 8 inputs (via one board) or 16 inputs (via two boards). High speed data is processed in one of two input modes: Sample or Glitch. In the Sample Mode, data present at an active clock transition is stored. In the Glitch Mode, data transitions taking place between active clock transitions are stored at the next active clock transition. The selected mode is valid for all 16 inputs.

This board has one level of triggering with three modes available: Combinational, Manual and Linked. The Combinational Mode allows the user to select the bit pattern and polarities that cause the trigger to complete after the link signal from the main channel is received. This mode also has a programmable filter available to require that the trigger combination be a minimum number of clock periods wide.

The Manual Mode permits the use of the front panel STOP key to cause a stop to occur. This key overrides the Combinational Mode, but does not change the trigger mode.

In the Linked Mode, the link signal from the Trace Control board enables the trigger mode. This may happen only once per recording. Status information contains the main inputs trace level from which the link signal was generated. Status information indicates if a trigger has occurred. Once a trigger has occurred, the programmed delay executes and the timing recording ends.

There are two delay modes available; delay by clocks and delay by events. In the delay by clocks mode, a programmed number (1 to 65,535) of clocks is counted and the recording ends. In the delay by events mode, a programmed number of combinational patterns (events) is counted, and at the selected event, the recording ends with that event being placed in memory at location 499.

The High-Speed board memory is organized as 1024 x 8 bits and gathers data at 100 MHz.

I/O Board

The I/O board supports the following:

1. One RS232 port and one AUX port (the AUX port is not currently supported)
2. One IEEE 488 Talker/Listener port
3. Two Floppy Disk Drives (5-1/4")

Various parameters such as file source, parity, and baud rates are selectable from the K105-D keypanel.

Chapter 2

SPECIFICATIONS

GENERAL

The following is a summary of the physical, environmental and operating characteristics of the K105-D.

POWER REQUIREMENTS

Input Frequency: 50-60 Hz
Input Voltage: 90-135 VAC or 180°-270 VAC
Input Power: 250 Watts without DOS option or 300 Watts with DOS option

Fuses for Rated Voltage:	<u>Voltage Range</u>	<u>Fuse</u>
	90 VAC to 135 VAC	3AG, 6 Amp
	180 VAC to 270 VAC	3AG, 3 Amp

PHYSICAL DIMENSIONS AND WEIGHT

Height: 8.54 inches (21.8 Cm) without DOS, 12 inches (30.1 Cm) with DOS
Width: 17.5 inches (44.5 Cm)
Depth: 24.7 inches (62.7 Cm) including handle.

Weight: minimum system - 35 lbs. (15.9 Kg)

1.0 lbs. (.45 Kg) per additional option board
15.0 lbs. (7.0 Kg) for DOS option
8.5 oz. (240 grams) per probe

ENVIRONMENTAL LIMITS

	<u>Operating</u>	<u>Storage</u>
Ambient Temperatures:	32° to 122°F(0° to 50°C)	-8°F to 117°F(-20°C to 50°C)
Relative Humidity:	20% to 80%	1% to 95%
Max Wet Bulb:	78°F (25°C)	No Condensation

PROBE INPUTS

Loading Characteristics

Signal Inputs:

Input Resistance: 1 megohm referenced to threshold

Input capacitance: ≤ 6 pF

NOTE: Input resistance may approach 500K ohms at voltages exceeding ± 15 volts from threshold.

Maximum input without damage: ± 50 volts peak

Common mode rejection: ± 0.5 volt max between probe and unit probed

Transfer Characteristics

Bandwidth: > 100 MHz

Min swing for output: threshold -0.20 V maximum

Threshold variance: ± 15 MV max channel to channel;
 ± 30 MV max, any two probes

MAIN INPUTS

32 (or 64) Main input channels contained in four sections, A, B, C, D of 8 (or 16) sample inputs each

Input Modes: Two modes, Sample and Demultiplex

Sample Input Frequency: 20 MHz

HIGH SPEED INPUTS

8 (or 16) High Speed input channels contained in single section, HS

Input Modes: Two modes, Sample and Glitch

Sample Input Frequency: 100 MHz

MAIN CLOCKS

Internal: Clock is selectable from 50ns (20MHz) to 50ms (20Hz) in a 1, 2, 5 sequence.

One internal clock may be programmed per recording.

External: 8 external clock inputs which may be combined to form 4 sample clocks and 1 master clock.

Maximum clock frequency for this mode is 20 MHz.

Minimum Detectable Pulse Width: 25ns

Skew Between Clocks: 15 ns, typical

HIGH SPEED CLOCKS

Internal: Clock is selectable from 10ns (100 MHz) to 50 ms (20 Hz) in a 1, 2, 5 sequence.

External: Two external clocks, HJ and HK are available as inputs and are ORed together. Each clock input is selectable as a rising or falling edge, or is not used.

Maximum external clock frequency is 14.3ns (70 MHz).

Minimum Detectable Pulse Width: 7ns

Skew Between Clocks: 2ns, typical

SIGNAL OUTPUTS

VIDEO OUT BNC Connector Output: 1V p-p into 75 ohms RS-170 compatible levels

MASTER CLOCK BNC Connector Output: TTL

LINK (Trigger) BNC Connector Output: TTL compatible

+5VDC (Accessory Power) two LEMO Connector Output: +5V and -5.2V @ 300 MA

SETUP AND HOLD

Data must be present 25ns before clock active edge

Data must be present 0ns, after clock active edge

Minimum detectable pulse width is one clock period +25ns

TRACE MEMORY

Trace memories M, A and B are 36 bits wide by 1024 bits deep; 32 bits store data and four bits store trace levels.

INTERFACE

Floppy Disk Storage System for Setup and Measurements

1 IEEE - 488/1978 Port for Talker/Listener Interface

1 RS-232 I/O Port for control, and printer output

1 Auxiliary I/O Port (RS-232 not presently supported)

UNPACKING AND INSPECTION

All equipment was thoroughly inspected and checked out at the factory prior to packaging for shipment. After removing the equipment from its shipping container, inspect for scratches, dents or other damage that might have occurred during shipping. Refer to the shipping papers to verify that all items were received.

If equipment received from the carrier is incomplete or damaged, do not install the equipment. File a claim with the shipping firm immediately, and notify Gould Inc., Design and Test Systems Division Customer Service department at once. Gould Inc., Design and Test Systems Division will arrange for repair or replacement of the equipment without waiting for settlement of the claim against the carrier.

PHYSICAL DESCRIPTIONS

GENERAL

This chapter presents illustrations and functional descriptions of the controls, switches and connectors located on the front and rear panels of the K105-D. Also included in this chapter is a description of the K105-D motherboard.

K105-D FRONT PANEL CONNECTORS AND SWITCHES

Figure 3-1 presents an overall view of the K105-D front panel. The components of the front panel have been categorized to simplify their description.

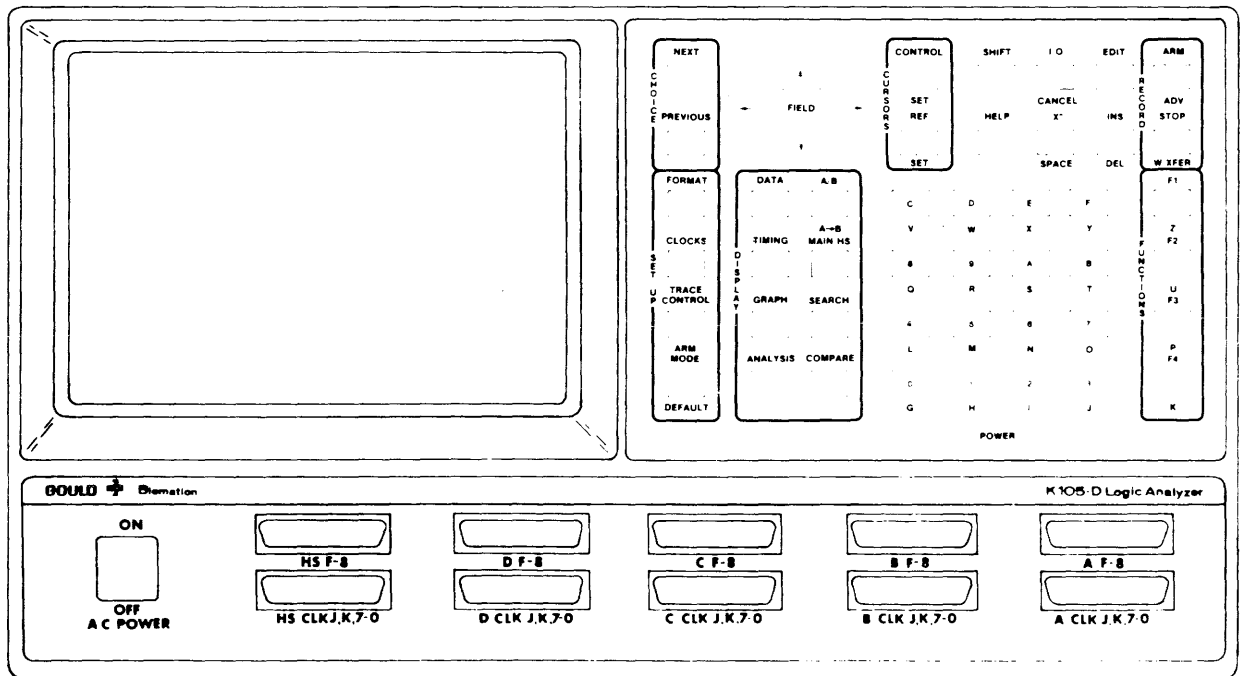

0014-3-1

Figure 3-1. K105-D Front Panel

Display

The K105-D employs a built-in 8 inch diagonal raster scan CRT for display of all indicators, menus and data.

AC Power ON/OFF and Power Indicator

The AC Power switch is a double-pole, single-throw paddle switch. The switch is in the OFF position when the paddle is down and in the ON position when the paddle is up. When the unit is on, the POWER indicator is illuminated indicating the presence of not only AC voltage but also the presence of -5 VDC.

Front Panel Connectors

The arrangement of front panel input connectors is shown in Figure 3-2. The front panel connectors, A(7-0) through D(7-0), A(F-8) through D(F-8), HS(7-0) and HS(F-8), are the data signal inputs to the K105-D. The number and configuration of input connectors available to the user is dependent on the options installed in a given unit. The following is a listing of the seven different option and connector configurations:

- 8 High Speed Inputs -- One connector HS(7-0)
- 16 High Speed Inputs -- Two connectors, HS(7-0) and HS(F-8)
- 32 Main Inputs -- Four Connectors, A(7-0) through D(7-0)
- 64 Main Inputs -- Eight Connectors, A(7-0) through D(7-0), and
A(F-8) through D(F-8)
- 32 Main Inputs with 8 High Speed Inputs -- Five connectors,
A(7-0) through D(7-0) and HS(7-0)
- 64 Main Inputs with 8 High Speed Inputs -- Nine connectors,
A(7-0) through D(7-0), A(F-8) through D(F-8) and HS(7-0)
- 32 Main Inputs with 16 High Speed Inputs -- Six connectors,
A(7-0) through D(7-0), HS(7-0) and HS(F-8).

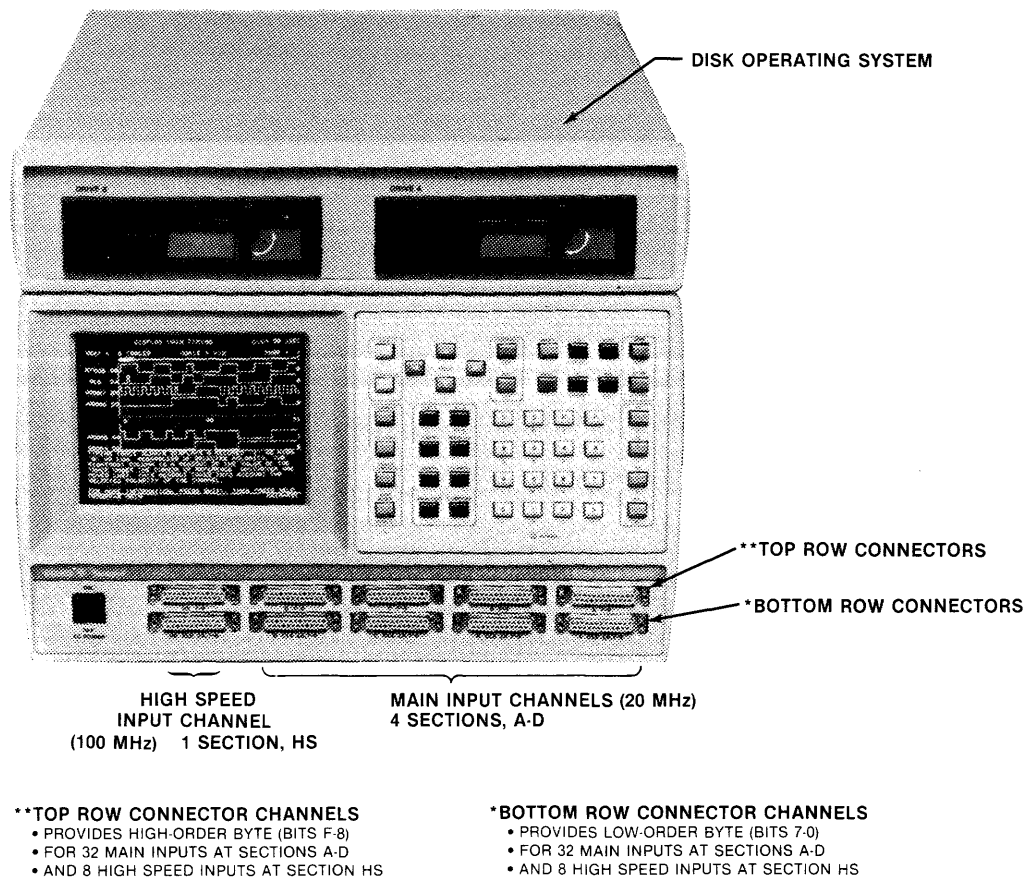

Figure 3-2. K105-D Arrangement of Input Connections

Keypanel

Figures 3-3 through 3-9 present detailed views of the major key groups of the K105-D keypanel. Brief descriptions of these key groups are provided following the figures, with detailed descriptions of key functions available in Chapter 4 of this manual.

The keys are arranged in the following functional groups which are described in subsequent paragraphs:

1. Screen Setup and Display keys
2. Control and Reference keys
3. Cursor Control keys
4. Edit keys
5. Record keys
6. Data Entry keys
7. Special Purpose keys

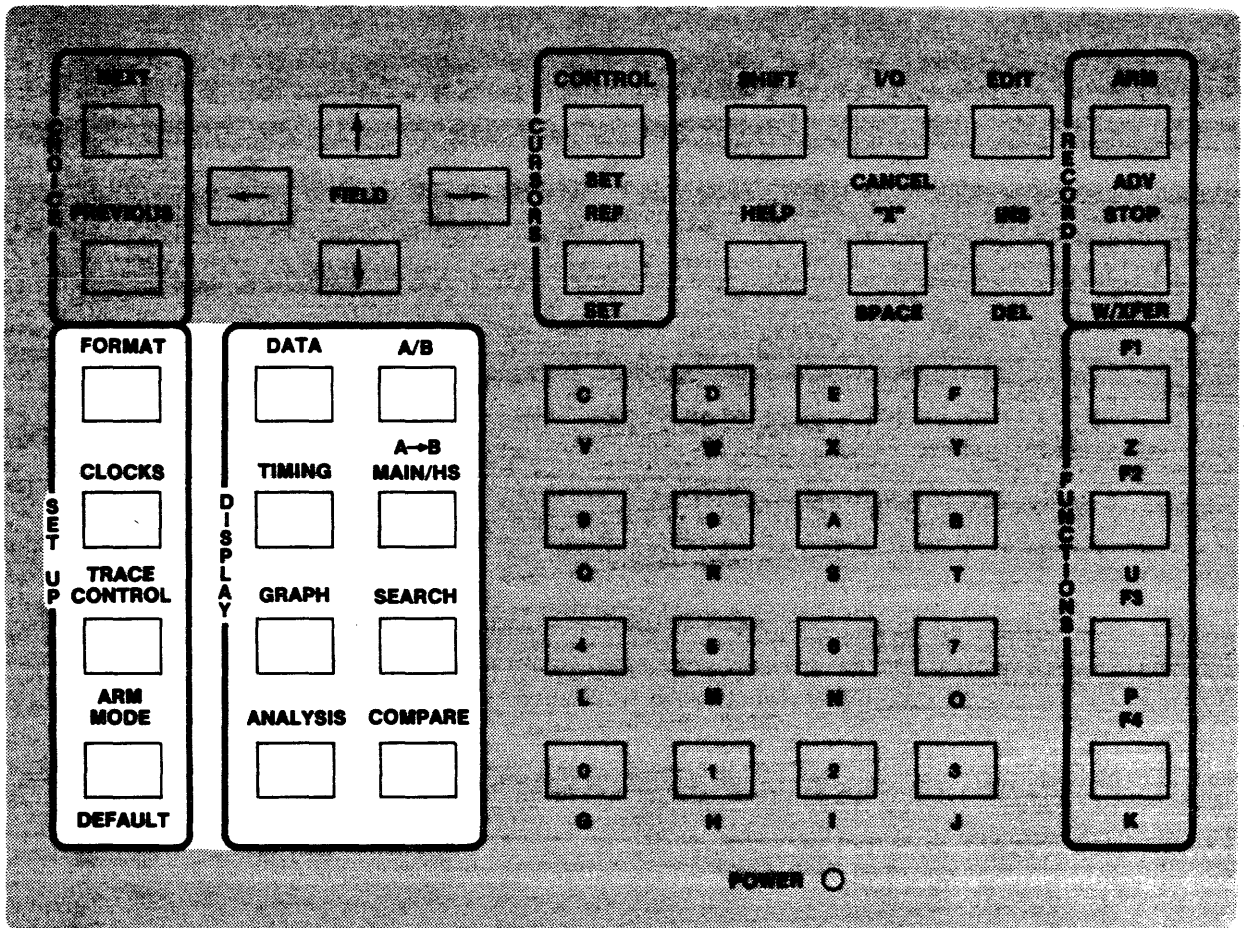

0014-3-2

Figure 3-3. Screen Setup and Display Key Group

Screen Setup and Display Key Group

Figure 3-3 illustrates the Screen Setup and Display key group. When the setup screens are initially accessed, the M memory parameter setups are displayed. This key group allows the user to select the different displays needed to setup new M memory parameters and compare current M memory parameters with previous parameters. Additionally, the user may use keys of this group for the following:

- To display data
- To call up one of the analysis options
- Select A or B memory displays
- Select either main or high-speed inputs displays
- Transfer A memory data to B memory
- Either search for a given channel configuration or compare A memory data to B memory data
- Reset the K105-D to its default state

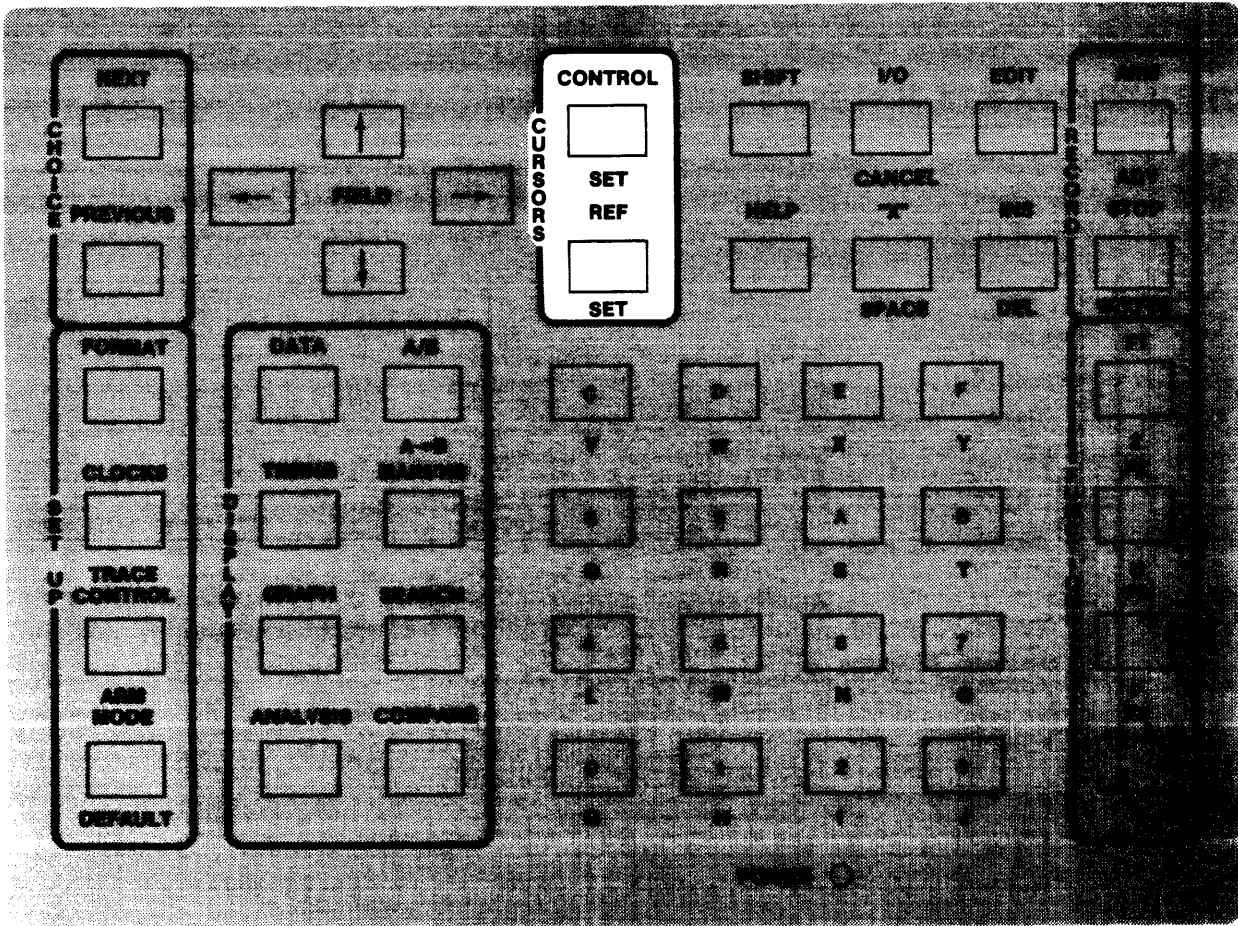

0014-3-3

Figure 3-4. Control and Reference Key Group

Control and Reference Key Group

The Control and Reference key group (Figure 3-4), enables the user to set the Control and Reference values for cursor movement which are used on the Data displays for locating specific items on the screen.

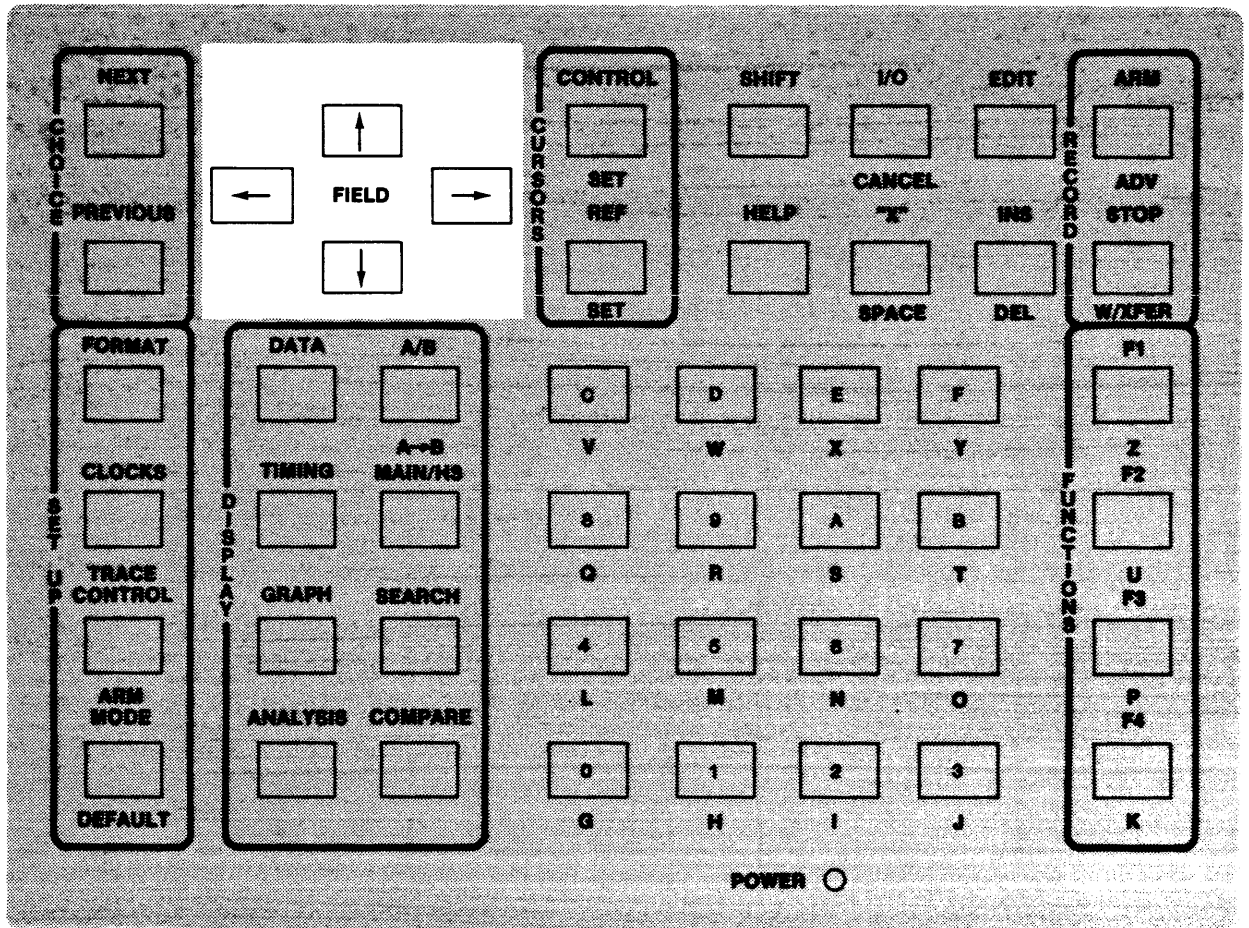

0014-3-4

Figure 3-5. Cursor Control Key Group

Cursor Control Key Group

The Cursor Control key group (Figure 3-5), provides the user with a means of manually moving the cursor and shifting active fields on the display. If the cursor is flashing, depressing the SHIFT key and -> key will suppress the flashing for most displays. Flashing is restored by depressing the -> key.

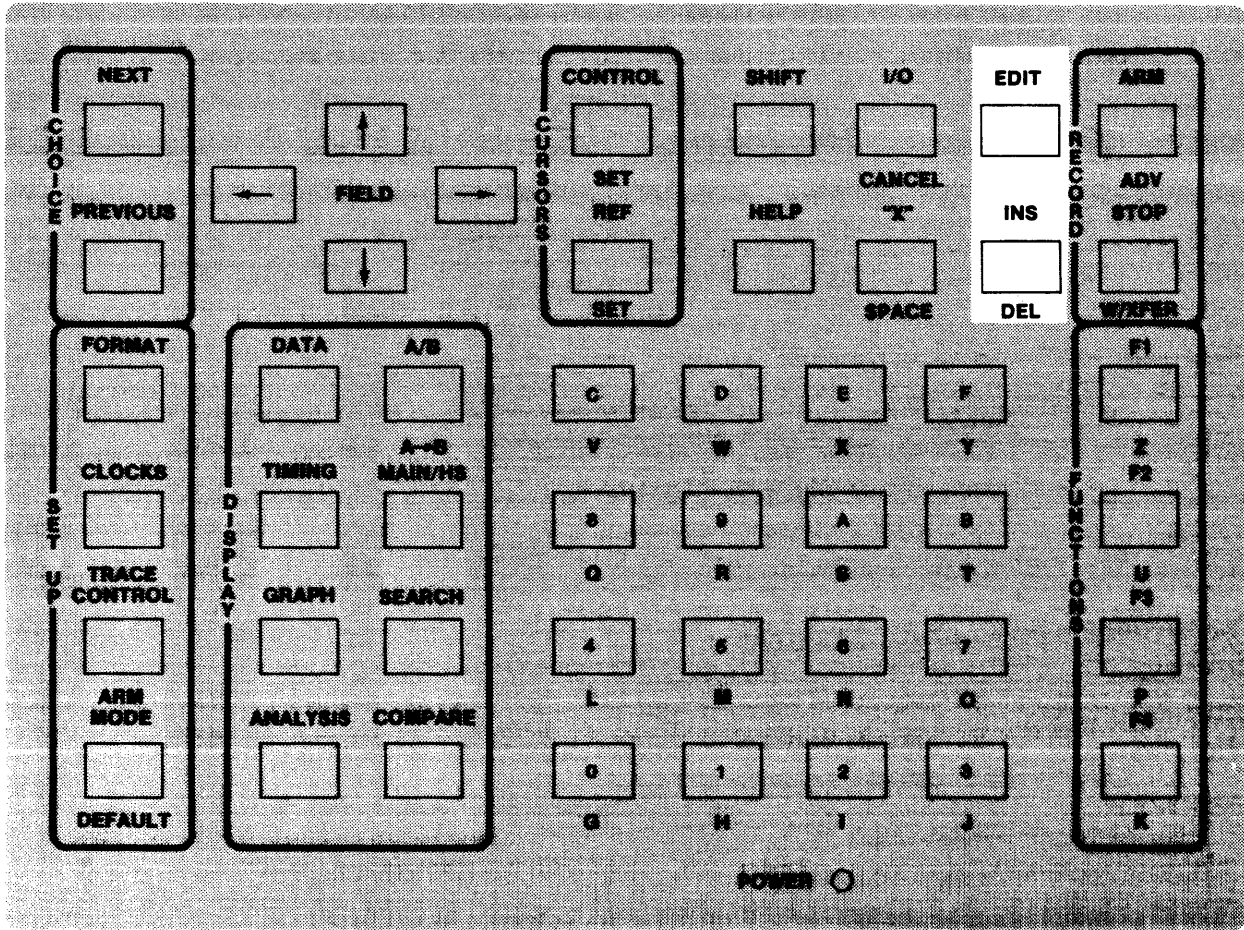

0014-3-5

Figure 3-6. Edit Key Group

Edit Key Group

The Edit key group (Figure 3-6) allows the user to place the Data screen into a mode in which the search word and/or level can be changed, and B memory data may be altered.

The user may also use this key group to place the Timing screen in a mode that allows resequencing of traces, changes of trace data in B memory, and entry of labels for specific fields.

Keys of this group may be used to insert and delete column information in certain displays. When in the Graph screen, this key group facilitates vertical expansion of data.

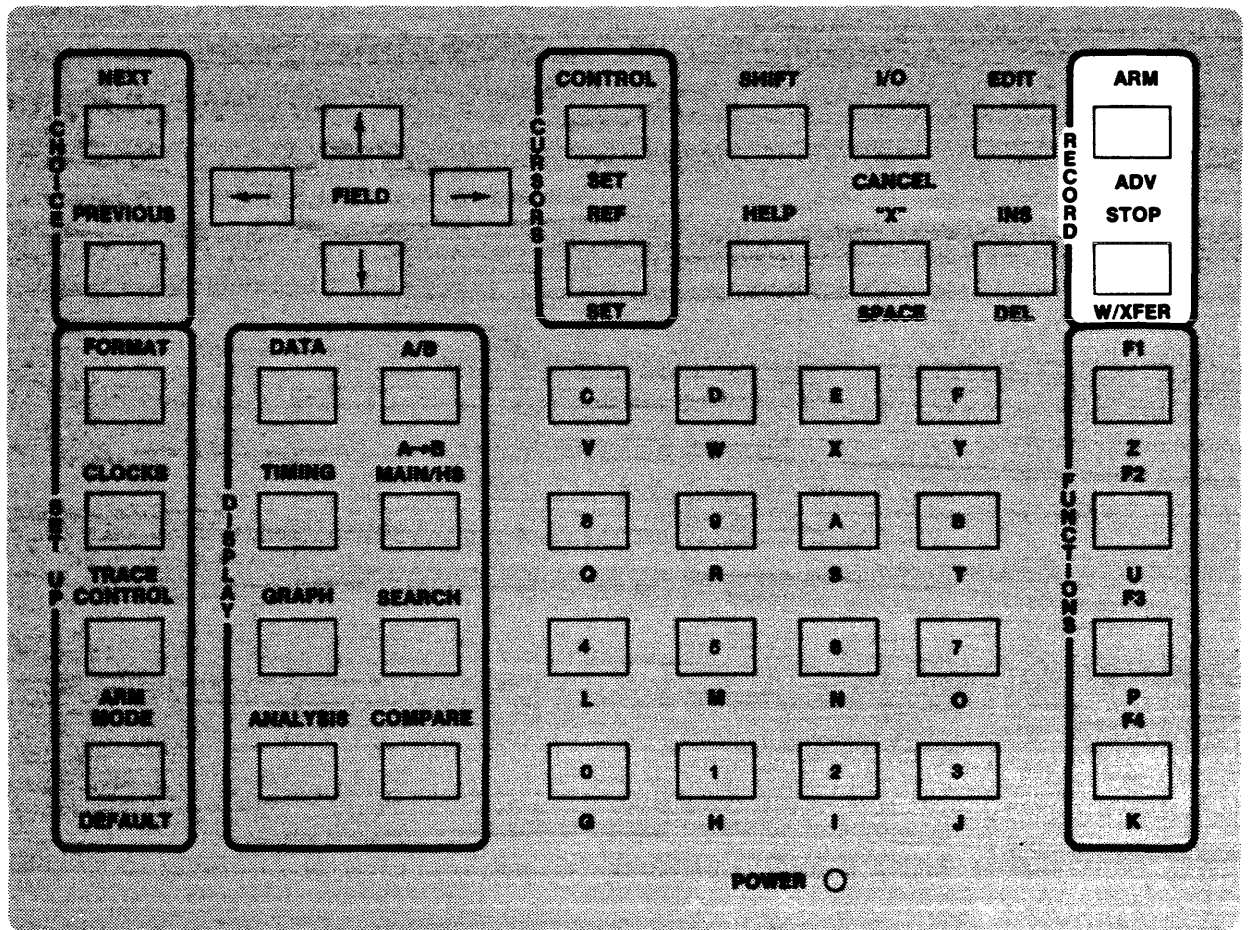

0014-3-6

Figure 3-7. Record Key Group

Record Key Group

The Record key group (Figure 3-7) enables the user to initiate a recording cycle, manually move to the next level of trace prerequisites, stop a recording, and manually transfer memory M to memory A.

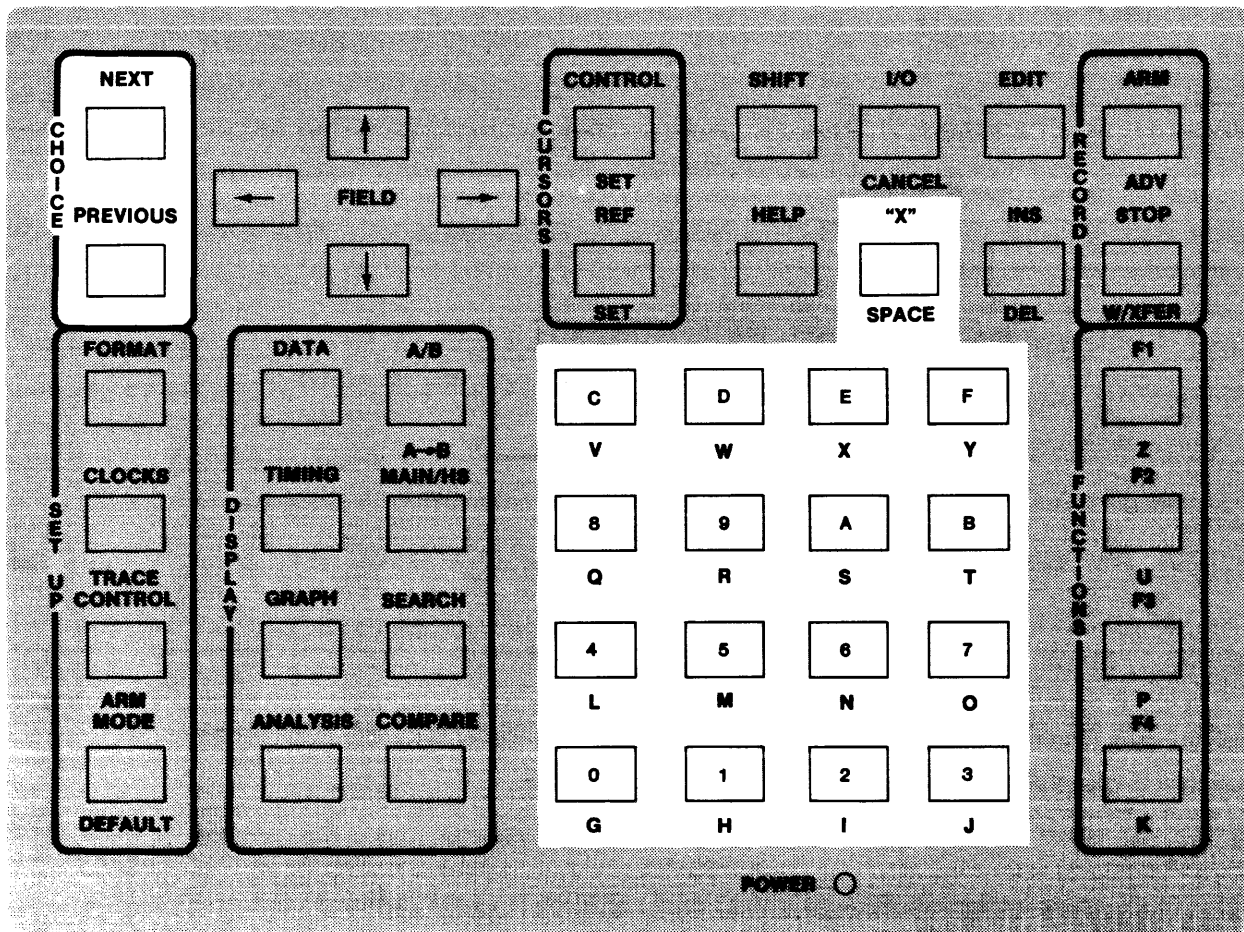

0014-3-7

Figure 3-8. Data Entry Key Group

Data Entry Key Group

The Data Entry key group (Figure 3-8) allows the user to manually enter alphanumeric information into the various displays. Please note that some of the alpha keys are located in the shifted positions of the FUNCTIONS Special Purpose Keys.

In addition to alphanumeric entries, this key group also enables the user to select the next and previous field values and insert spaces or don't-care values into certain displays.

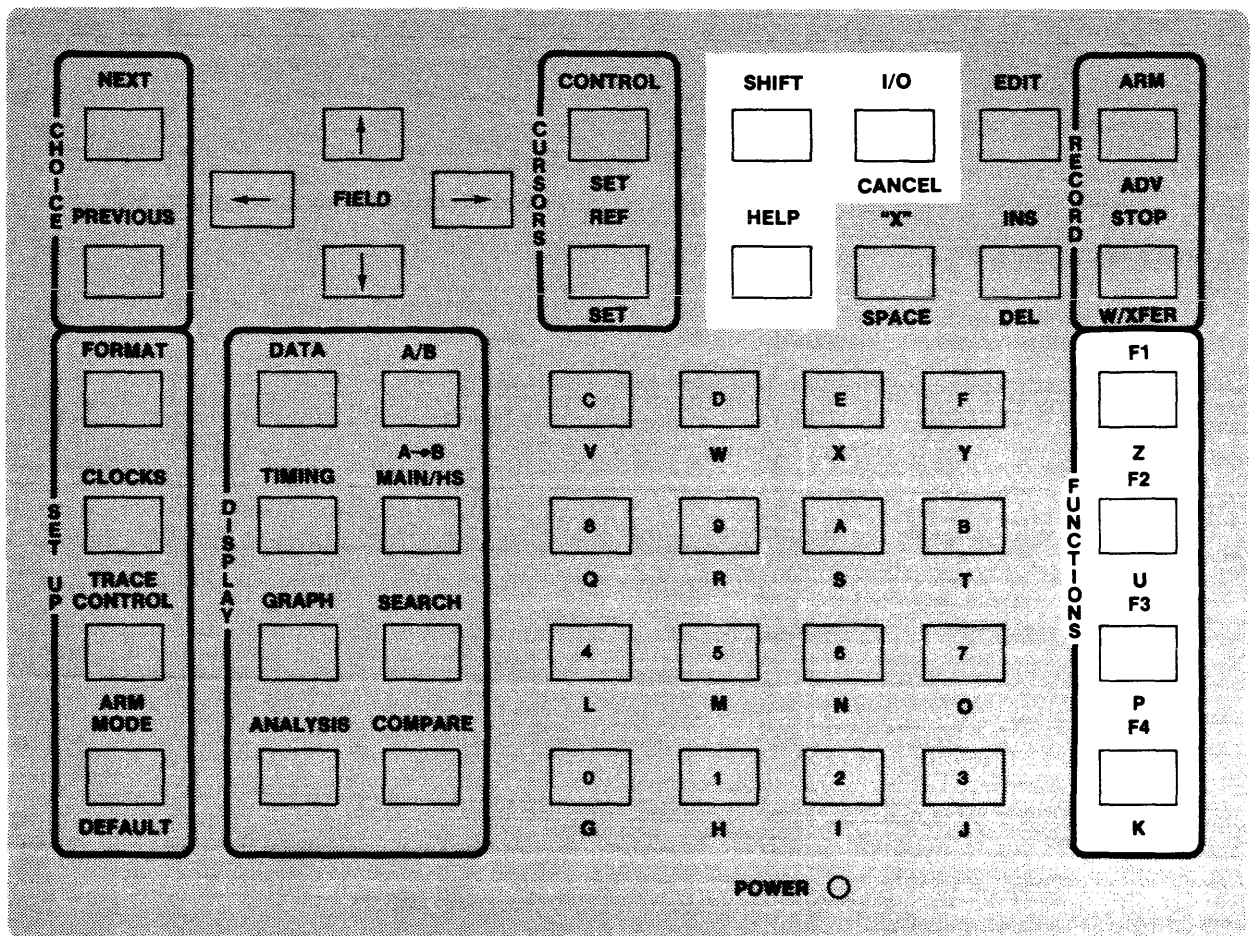

0014-3-8

Figure 3-9. Special Purpose Key Group

Special Purpose Keys

The Special Purpose key group (Figure 3-9) includes the function keys which change their purpose depending on the screen selected. In addition, this key group allows the user to shift the keyboard functions to their secondary functions, select the Help displays, and access external interface. The Help function provides the user with access to 8-line prompting messages or to the internal 28-page User's Manual which is driven by resident firmware.

REAR PANEL CONNECTORS AND SWITCHES

Figure 3-10 presents an overall view of the K105-D rear panel. The components of the rear panel have been categorized into three groups: interface, power input and signal output. The user should note that the arrangement of the interface connectors may vary on some models of the K105-D.

Interface Group

IEEE-488 Port

The IEEE-488 port is of standard configuration with full Talker/Listener capabilities. This port is configured through the I/O Set Up screen. Table 3-1 lists the connector pin-descriptions for the IEEE-488.

Table 3-1. K105-D I/O IEEE-488 Connector Pin-Descriptions

PIN NUMBER	SYMBOL	DESCRIPTION
1	D101	Data Input Output 1
2	D102	Data Input Output 2
3	D103	Data Input Output 3
4	D104	Data Input Output 4
5	E01	End or Identify
6	DAV	Data Valid
7	NRFD	Not Ready for Data
8	NDAC	Not Data Accepted
9	IFC	Interface Clear
10	SRQ	Service Request
11	ATN	Attention
12	Shield	
13	D105	Data Input Output 5
14	D106	Data Input Output 6
15	D107	Data Input Output 7
16	D108	Data Input Output 8
17	REN	Remote Enable
18	GND	Signal Ground Return for Pin 6
19	GND	Signal Ground Return for Pin 7
20	GND	Signal Ground Return for Pin 8
21	GND	Signal Ground Return for Pin 9
22	GND	Signal Ground Return for Pin 10
23	GND	Signal Ground Return for Pin 11
24	GND	Logic Ground

RS-232C Ports

The RS-232C ports are seven wire subsets with standard pin-outs. The ports are factory configured as DTE. Instructions on reconfiguring the ports as DCE may be obtained from Gould Inc., Customer Service office listed in the Preface. Table 3-2 lists the pin-designations for the K105-D RS 232C ports.

Table 3-2. K105-D RS-232C Port Pin-Descriptions

Pin Number	Name	DTE Sender	DTE Receiver
2	BA	Transmit Data	Receive Data
3	BB	Receive Data	Transmit Data
4	CA	Request to Send	Data Set Ready
5	CB	Clear to Send	Data Terminal Ready
6	CC	Data Set Ready	Request to Send
7	AB	Ground	Ground
20	CD	Data Terminal Ready	Clear to Send

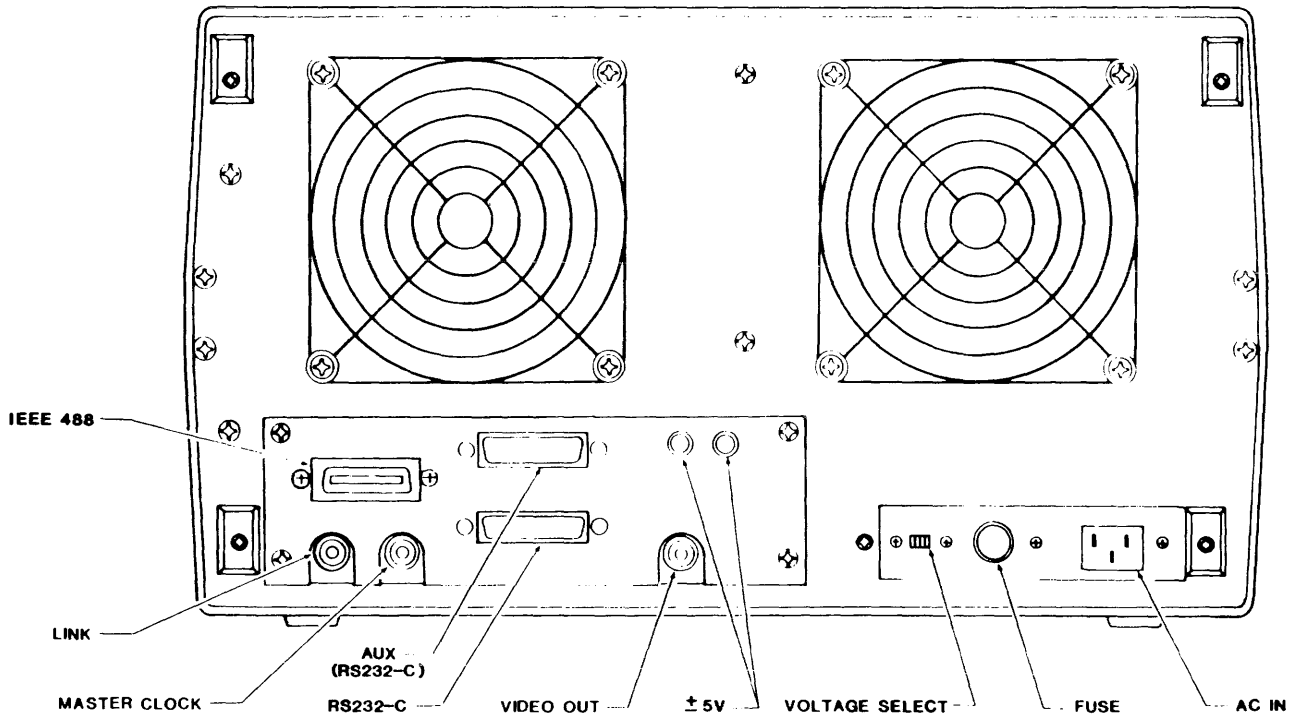

0114-5-0

Figure 3-10. K105-D Rear Panel

Power Input Group

Voltage Select: This two position switch selects the voltage range of the unit to match the incoming AC Line voltage.

Fuse: Standard fuse holder. Fuse ratings must be selected to match the incoming AC Line voltage.

Fuses for Rated Voltage

<u>Voltage</u>	<u>Fuse</u>
90 VAC to 130 VAC	3AG, 6 Amp
175 VAC to 260 VAC	3AG, 3 Amp

AC IN: Standard AC, male, connector for power input.

Signal Output Group

Link Output: Standard BNC connector provides triggering at TTL voltage level which detects the occurrence of a user programmed event (or Link) in the trace control. The Link Signal goes high when the first event occurs in the trace and remains high until the end of the recording.

Master Clock Output: Standard BNC connector provides Master Clock signal at TTL voltage level. The Master Clock is used to shift samples into memory and the trace control logic. Clock transitions of the rising or falling edge are selectable by the user to establish the active/inactive states.

Video Output: Standard BNC connector provides RS-170 composite video output.

+5V, -5V Output: Standard LEMO connectors provide output signal for driving user accessories within the range of +5V and -5.2V @ 300 MA.

OPERATION

GENERAL

This chapter describes the Gould K105-D operating procedures and guides the user in setting up the equipment and operating the keyboard to perform the analysis. Various techniques can be employed to locate and identify malfunctions in the user's target hardware. The best approach for applying K105-D capabilities depends upon the user's familiarity with basic techniques for analyzing digital circuit functions and how to make full use of the K105-D instrument resources. These instrument resources are sophisticated analysis tools in the form of menu-driven displays that setup test actions, perform measurements, track and control input signal characteristics, record test data and display the results upon demand.

A detailed description of each display screen and data fields within the display is provided to guide the user in selecting and interpreting the display contents. The methods by which the various keys can be used to reconfigure and alter these displays are also explained. The functions of certain keys and selected display elements are explained at the beginning of this chapter, and in the interest of brevity, no further discussions of these items will be made when dealing with the individual displays.

The user should note that the displays in this chapter are shown in reverse video (black on white).

USER AIDS

The K105-D firmware generates Help Messages that provide instructions to the user for understanding a specific operation. The associated help message for a given display can be accessed at any time by depressing the HELP key. The message appears at the lower portion of the current display.

The firmware also stores an On-Line User's Guide manual that provides in-depth information about the display operation. If the user requires additional instructions, other than those provided by the Help Message, the On-Line User's Guide manual can be accessed at any time by depressing the SHIFT and HELP keys. The On-Line User's Guide manual contains several text pages of information and the user may advance to the next text page by depressing the NEXT key, or return to the previous text page by depressing the PREVIOUS key.

ORGANIZATION OF DISPLAYS

The organization of K105-D display screens is shown in the menu-tree diagram of Figure 4-1. These displays consist of three major groups, setup, analysis and I/O. The K105-D input probe cable must be connected to the user's external equipment to supply input signals that are interrogated by the K105-D internal logic and displayed on the screen. The various display screens are used to setup the test conditions, display the analysis results and perform I/O transfers to other equipment units.

The entry point at the top of the diagram (Figure 4-1) begins with the Power switch. Turning on the AC power initializes the instrument, causing it to perform a self-test diagnostic of internal circuit functions and present the Display Options screen when the diagnostic is completed. The Display Options screen presents the configuration of the K105-D by indicating which hardware options are present and the number of inputs available to the user. The Display Options screen may also be accessed by depressing the SHIFT and DEFAULT keys.

The first functional group of displays, under Instrument Setup, allow the user to define various test conditions. The name of the control panel key(s) that is used to access the display is enclosed by parenthesis adjacent to the block identifying the display. For example, to access the Auto Compare Setup screen, it is necessary to depress the SHIFT and COMPARE keys.

The second functional group of displays, under Display and Analysis, allow the user to observe displayed data and graphic information that presents the results of the analysis. Note that the selection of displays for main inputs and high speed inputs are controlled by toggling the MAIN/HS key. Also, the Noise Margin Analysis screen is not available for high speed configurations that do not contain the high-order input bits (8-F). Also, the Percent vs. Time Histogram display is not available for the high speed configuration under any condition. Again, the name of the key(s) that is used to access the display is enclosed in parenthesis adjacent to the display.

The last functional group of displays under I/O Function, allow the user to perform various I/O transfers of information generated by the K105, as determined by communications linkage via the RS232 and GPIB interface. The I/O display can be accessed at any time without disrupting data presented in the displays.

The Help Messages screen and User Guide Screen can be accessed at anytime by depressing the specified keys. Likewise, the blinking of the cursor can be controlled at any time by depressing the specified keys.

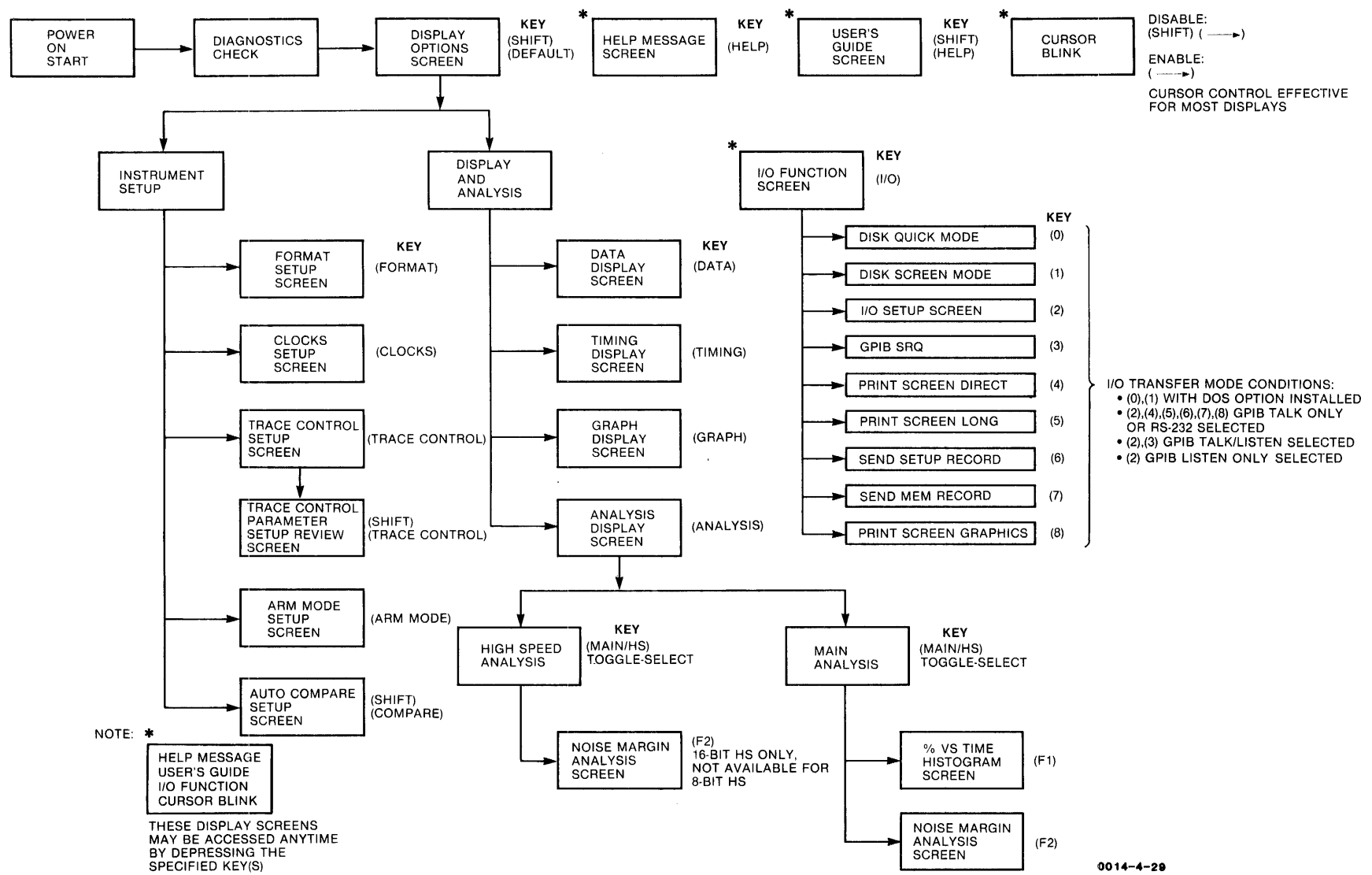

Figure 4-1. K105D Organization of Displays

GETTING STARTED

The following example presents a simplified procedure for connecting the K105-D to the user's equipment and operating the control panel keys to generate a recording of the input signal.

In this example, the user's equipment consists of a signal generator unit or equivalent equipment that can be adjusted to provide an output signal with the following characteristics:

- TTL Logic Level
- Square Wave or Pulse Train frequency of approximately 1 MHz

1. Connect Probe Cable to K105-D:

- a. Verify AC power is off and plug the K105-D Probe Cable assembly into the front panel input socket labeled D CLK J, K, 7-0.
- b. Connect the flying leads to the probe.
- c. Turn on AC power at the K105-D to initialize the unit. The unit will respond by executing the start-up diagnostics and presenting the Display Options screen.

2. Connect Probe Cable to User's Equipment:

- a. Turn on AC power at signal generator unit and verify the controls are positioned to generate an output signal at 1 MHz frequency and TTL logic level.
- b. Plug user's signal cable into output jack of signal generator unit.
- c. Connect K105-D probe tip (brown wire) labeled GND to ground lead of signal generator cable.
- d. Connect K105-D probe tip (orange wire) labeled 3 to signal lead of signal generator cable.

3. Take Recording of Input Signal:

- a. Depress TIMING key and ARM key (located at upper right corner of panel) to take a recording of the signal. The K105-D will respond by displaying the trace data on line D3 at the right half side of the screen.
- b. Observe the Timing Display screen which presents the following information:
 - 1) Timing display indicates Main Channel inputs are selected. (This information is contained in the title at top of screen.)
 - 2) Input signal trace appears at input line D3
 - 3) Horizontal Expansion = X1 size. (This information is located under the title at top of screen.)

NOTE: If the wrong key is pushed, the K105-D can be reset at any time by depressing the SHIFT, DEFAULT and F1 keys in sequence to restore the Display Options Screen.

Likewise, the SHIFT, DEFAULT, F2 keys may be depressed in sequence to re-initialize the power-up diagnostics and restore the Display Options Screen.

4. Take Another Recording of Input Signal:

- a. Reduce signal generator frequency to 500 KHZ and depress the ARM key to execute the new trace recording.
- b. Observe the shape of the signal on the display screen which becomes altered to reflect the new frequency. This new frequency pattern is recorded by the K105-D.

5. Expand Timing Display Horizontally:

- a. Depress and hold the FIELD -> key until the CONTROL block at lower left side of the screen indicates a count value of approximately 500. Then release the -> key. Observe that cursor line has shifted from the far left side to the center of the screen.
- b. Depress the F3 key one time to expand the screen to X6 size. Observe the control cursor is again relocated to the left side of the screen and the screen is expanded with data beginning at the cursor.
- c. Depress the F3 key a second time to expand the screen to X12 size. Observe the shape of signal changes to reflect the increased screen size.
- d. Depress the F3 key a third time to expand the screen to X24 size. Observe the shape of signal changes to reflect the increased screen size.
- e. Depress the F3 key a fourth time to restore the screen to the X1 size. Observe the shape of signal changes to indicate the new screen size.

6. Perform Additional Measurements and Recording

At this time, the user can experiment by accessing various displays described in subsequent sections of this chapter.

The lowermost character line of the displays, line 29, contains several common display elements. The display element farthest to the left (MEMORY=) indicates the memory information currently being displayed. The user must understand that there are three Set Up memories and three Data memories. Although the designations of both of these two groups of memories are the same, M, A and B, their functions are vastly different. The user's ability to view them is dependent on his selection of screens. If the user has selected any of the Set Up screens (Format, Clocks, Trace Control or Arm Mode), he may view any of the three setup memories. Set Up memory M displays the parameters selected for the next acquisition cycle, Set Up memory A displays the parameters selected for the acquisition cycle just completed and Set Up memory B may be used for storage of Set Up memory A information for future reference. The Data memories are associated with certain Display screens (Data, Timing, and Graph), and unlike the Set Up screens, cannot all be viewed by the user. The Data memory M is a high-speed acquisition memory which is transferred to memory A at the completion of each acquisition cycle and therefore, is not available to be viewed by the user. Data memory A stores the data acquired during the last acquisition cycle and Data memory B may be used for storage of the data in memory A for future reference or comparisons. Both Data memories A and B may be readily viewed by the user.

Immediately to the right of the MEMORY= display element is an element that indicates which input displays are currently being viewed: Main or High Speed (HS). The element adjacent to the right of this element indicates when the SHIFT keybutton has been pressed, and the keypad is in its shifted mode of operation (the blue designators below the keybuttons are functional).

To the far right of this same character line is a display element (MAIN=) that indicates the status of the Main inputs. The status messages are as follows:

RDY - indicates the main inputs are ready for an arm signal.

BUSY - indicates the hardware is in the process of being prepared for a record cycle.

CLK? - indicates the unit is awaiting a clock to start a recording.

LVL0 through LVL7 - indicates the trace control level in which the unit is currently operating.

EOR - indicates End of Recording.

Immediately to the left of the MAIN= element is the high-speed inputs status indicator, HS=. This display element is present only when the high-speed boards are installed in the unit and selected from the Arm Mode and the unit has been armed. Although the status indicator names are similar to those of the main inputs status indicators, some of their functions differ. The high-speed status indicators are defined as follows:

RDY - indicates that the high-speed inputs are ready to be prepared for a record cycle.

BUSY - indicates the hardware is being prepared for a record cycle.

CLK? - indicates the high-speed inputs hardware has been prepared for a record cycle and is awaiting an arm signal.

LNK? - indicates the high-speed inputs are armed and awaiting a link signal.

DLY? - indicates the delay specified in the High Speed Set Up screen is in the process of being counted.

EOR - indicates End of Record.

COMMON KEY FUNCTIONS

When the user has selected a Set Up screen such as Format, Figure 4-3, he should note there are several display elements highlighted by reverse video.

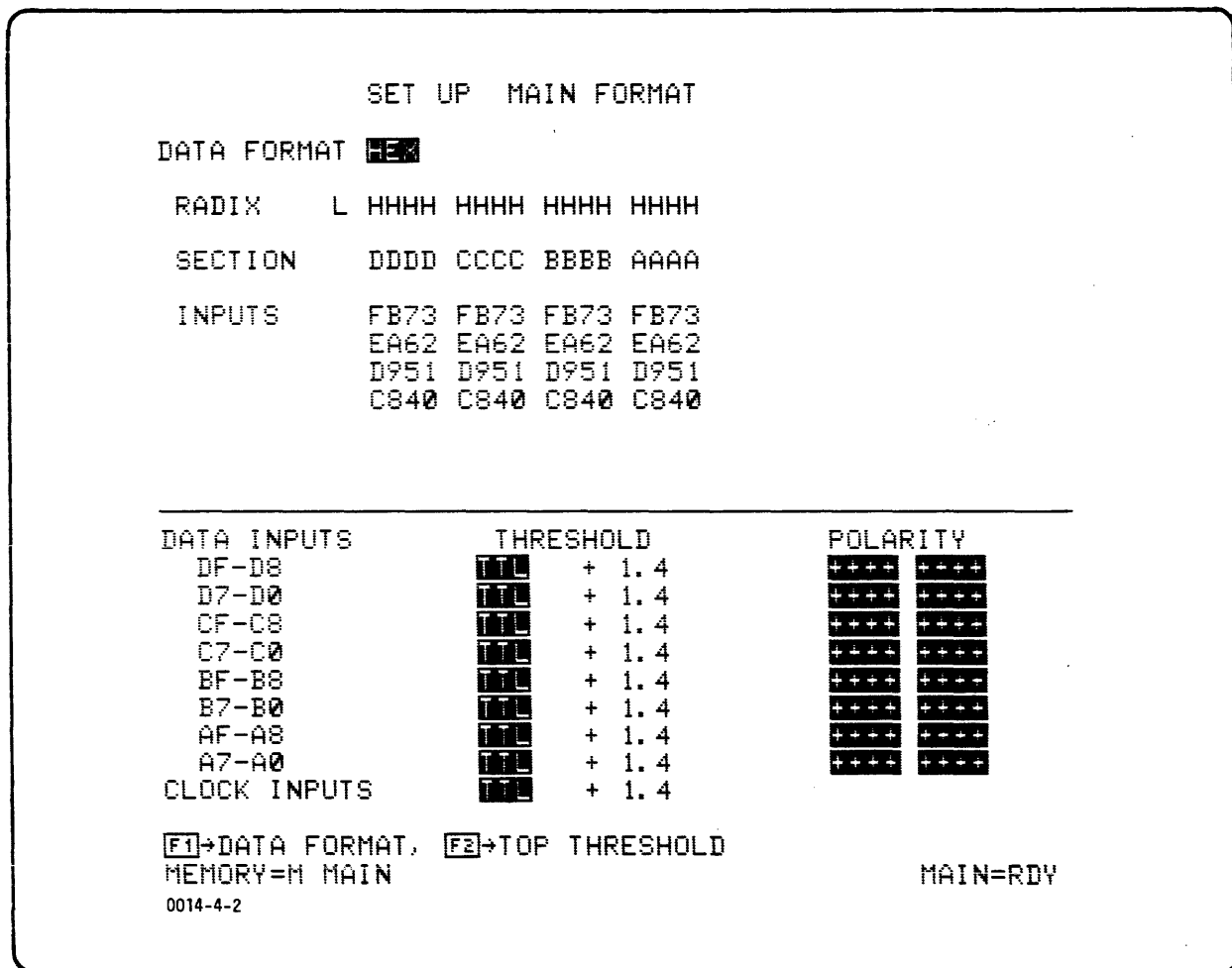

Figure 4-3. Typical Screen Display

These elements are referred to as fields, and information may be entered into them or the information within them may be altered. The user should also note one of these fields is further highlighted by blinking reverse video. The blinking reverse video indicates this field is the one selected for immediate data entry or alteration; for this reason, this field will henceforth be referred to in this text as the active field. Positioning of the active field indication is controlled by use of the FIELD keys. The right and left arrow keys allow the user to reposition the active field laterally along the current character line. When the active field reaches the last available field in this character line, it wraps around to the first available field at the opposite end of the line. The up and down arrows permit the user to move the active field vertically through those character lines containing fields. A wraparound is performed at the uppermost or lowermost fields. The FIELD keys also perform other functions in specific displays. These functions will be discussed in the descriptions of the display operations.

Many of the display fields (such as the Data Format field of the Format screen) have multiple-choices of data or information. When the field is active, the user may scroll forward or backward through the choices using the NEXT or PREVIOUS keys, respectively. Rapid selection of choices is facilitated by use of what is referred to as "Quick-Keys". Choices are assigned alphanumeric values, and the user may rapidly advance to another choice with a single depression of the alphanumeric key whose value corresponds to the Quick-Key value. As the various fields of each display are discussed in this text, the Quick-Key values of each choice will be given in parenthesis; for example - (8).

Many of the keys on the keypad serve a dual function. The primary function of the keys is printed either directly on the keybutton or immediately above the keybutton in black lettering. The secondary function of dual-function keys is printed directly below the keybutton in blue lettering. To use the secondary functions, the user must first depress the SHIFT key and then the desired secondary function key. Ordinarily, the user must make a depression of the SHIFT key for each depression of a secondary function key, but in the event that he wants to make several like entries in a row, he may hold the secondary function key depressed causing it to go into a repetitive mode of operation.

There are two levels of the Help function available in the K105-D. The user may access the first level of Help (Figure 4-4) by depressing the HELP key when in any of the Set Up or Display screens. Eight lines of information are presented in either the upper or lower half of the screen, dependent on the location of the active field. The information provided is pertinent to the field that is active.

SET UP MAIN FORMAT

DATA FORMAT **HEX**

RADIX L HHHH HHHH HHHH HHHH

SECTION DDDD CCCC BBBB AAAA

INPUTS FB73 FB73 FB73 FB73
EA62 EA62 EA62 EA62
D951 D951 D951 D951
C840 C840 C840 C840

DATA INPUTS

THRESHOLD

POLARITY

DF-D8 **TTL** + 1.4

++++ **++++**

D7-D0 **TTL** + 1.4

++++ **++++**

CF-C8 **TTL** + 1.4

++++ **++++**

SELECT FORMAT OF RECORDED DATA DISPLAY. 0 (HEX), 1 (OCTAL), 2 (BINARY-SECT A0-D7), 3 (BINARY-SECT A&B), 4 (BINARY-SECT C&D), 6 (DISASSEMBLER) ARE FIXED FORMAT DISPLAYS. USER SPECIFIED (5) ALLOWS FOR A FLEXIBLE ARRANGEMENT OF CHANNELS INTO GROUPS WITHIN EACH SECTION. NEXT & PREV KEYS CYCLE THROUGH FIELD CHOICES.

FOR MORE INFORMATION, PRESS SHIFT, THEN PRESS HELP.

MEMORY=M MAIN

MAIN=RDY

0014-4-3

Figure 4-4. First Level Help Message

The second level of Help (Figure 4-5) is accessed by depressing the SHIFT key and then the HELP key. This level of Help provides detailed discussions on operation of the K105-D.

K105D USER'S GUIDE

THE INFORMATION IN THE ON-LINE USER'S GUIDE IS ACCESSED BY MEANS OF THE FRONT PANEL KEYS. THE 'NEXT' AND 'PREV' KEYS ALLOW THE USER TO PAGE THROUGH THE INFORMATION SCREENS ONE AT A TIME. IN ADDITION, THE TOPIC OF INTEREST MAY BE ACCESSED DIRECTLY BY REFERRING TO THE MENU SHOWN BELOW AND PRESSING THE KEY INDICATED.

TO LEAVE THE HELP FUNCTION, PRESS ANY OF THE SCREEN SET UP KEYS OR DATA DISPLAY KEYS.

TOPIC -----	QUICK KEY -----
RECORD PARAMETERS: MAIN INPUTS	1
RECORD PARAMETERS: HIGH SPEED	2
ARM AND RECORD	3
RECORDED DATA	4

PRESS 'NEXT' TO CONTINUE, 0 + INITIAL MENU

MEMORY=M MAIN

MAIN=RDV

0014-4-4

Figure 4-5. Second Level Help Screen

The discussions provided by the second level Help are arranged into four major categories:

1. Main Inputs Record Parameters
2. High-Speed Record Parameters
3. Data Acquisition
4. Data Display

Each category is further subdivided to provide the user with sufficient information on K105-D operation. When in any of the various discussion screens, depression of the (0) quick-key returns the user to the initial Help screen.

The K105-D contains a tolerance comparison analysis memory (don't-care memory) which allows the user to designate sample data not to be included in a comparison. The don't-care memory is initialized to all do-cares; as a result, all of the sample data is included in a comparison. Generally, when the "X"/SPACE key is depressed the control firmware decides if a don't-care, "X", is appropriate in the active field and if so, inserts it. If an "X" is not appropriate, a space is placed in the field. When editing pattern definition fields, memory B data columns, search values and certain fields relative to the disk system, either an 'X' or a space is appropriate and the user must decide which he wants. In these cases, it is necessary to insert spaces by depressing SHIFT-'X'. The user should note that a SHIFT-'X' is never interpreted as a don't-care.

In many cases, the active field consists of a single character. When a space is appropriate in the active field, depression of the "X"/SPACE key deletes the character in the active field and replaces it with a blank space while having no affect on the adjacent characters.

In order to use the "X"/SPACE functions in the Data and Timing Display screens, the screens in which comparisons are performed, the user must be in the Edit mode. The Edit mode is entered by depressing the EDIT key which allows the user to perform editing functions in the Data, Timing and Graph Display screens. In the Trace Control Set Up screen, the user may use the EDIT key to select a binary presentation of the Pattern Definitions.

The insert and delete key, INS/DEL, is used in the Format Set Up screen to either insert additional columns into the display or delete existing columns from the display. As additional columns are inserted, the columnar information initially present on the screen is shifted right in its entirety. The user should note that information shifted off the screen cannot be returned. When using DEL in this screen, columnar information is deleted, and the remaining information is shifted left to fill the void.

The INS/DEL key serves a function similar to the above when in the edit mode of the Timing Display screen. Entire lines may be inserted or deleted and the lines below shift down or up, respectively. The user should note that more than 128 insertions in the main inputs display or 32 insertions in the high-speed inputs display will cause information to be lost.

ARM/ADV Key

The ARM/ADV key may be used for any display. After the user has set up all desired parameters in a display, he may initiate a data recording by depressing the ARM/ADV key. This referred to as arming the instrument. The Arm Mode screen determines which actions are taken when the instrument is armed. Both the Main and High Speed inputs may be armed together, or the user may choose to arm either one without the other.

When the instrument is armed, the status line is altered to only display the status of the inputs that are armed. An arm cycle consists of:

- (1) setting up the acquisition hardware,
- (2) start of acquisition,
- (3) hardware acquires data while looking for the stop event,
- (4) stop event occurs,
- (5) acquired data is transferred from the hardware into Memory A, and
- (6) the system decided whether to repeat the arm cycle automatically.

If an advance condition is not found, when the unit is recording, the user may force an advance by depressing the ADV key (the shifted function of the ARM key). This operation applies only to the main inputs trace setup.

STOP/W/XFER Key

During the process of a recording, the user might have need to stop the recording. For example, this could occur due to a failure in the system under test, which prevented the trace operation from advancing to the next trace level. The user may stop the recording simply by depressing the STOP key. The recording stops with no transfer of data from data memory M to data memory A. If the user wishes to stop with an M to A data memory transfer, he must depress W/XFER (the shifted function of STOP). The STOP key is also useful for stopping the unit when in Auto mode.

FORMAT SET UP SCREEN

Probes

The Format Set Up screen allows the user to specify the display format used in the Data Display screen. Because of the close relationship of the probes to the Format Set Up screen, a discussion of the probes is necessary prior to discussing the Format Set Up screen.

Figure 4-6 illustrates a typical probe consisting of the D-connector, cable, probe case, probe tip with input lines and the grabbers which attach to the input lines.

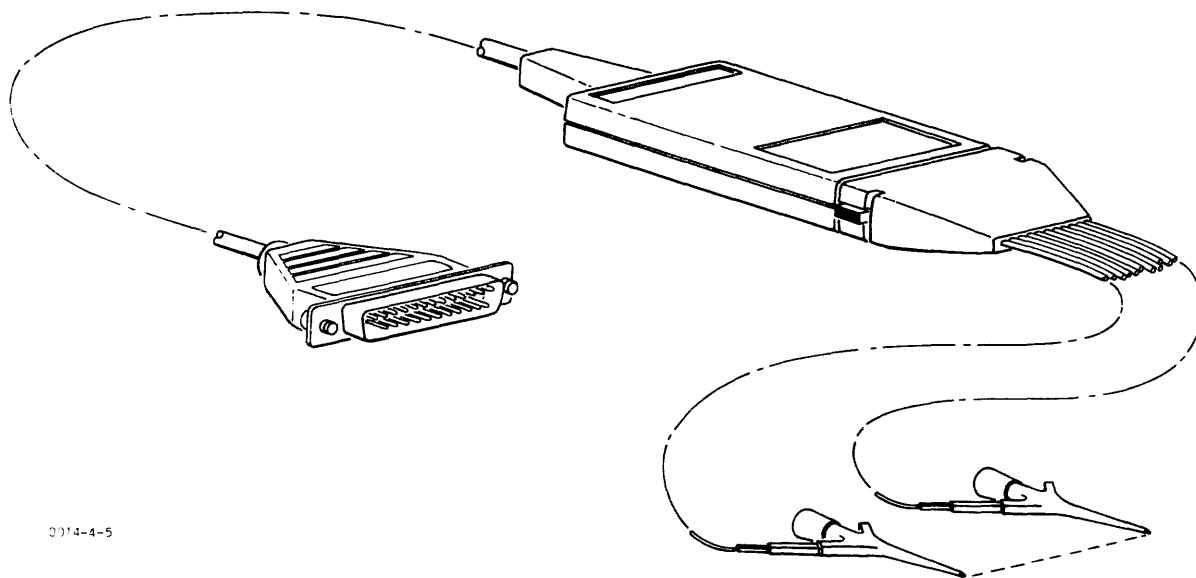

0014-4-5

Figure 4-6. Typical K105-D Probe

FORMAT SET UP SCREEN (Cont'd)

Probes (Cont'd)

The probe assembly D-connector is labeled to indicate which of the K105-D's front panel D-connectors it attaches to. Additional identification of the probe assembly consists of a label on the probe case which identifies the probe and the attached color coded input lines. The user should note that the individual input lines are further alpha-numerically identified at their tips, where the grabbers attach. The input line identifiers used on the probe case label are directly associated with the section and input identifiers used in the Format Set Up screen, Figure 4-7. The probes are electrically interchangeable, but the user should note that the F-8 sockets have no clock receivers.

```

                SET UP  MAIN FORMAT

DATA FORMAT HEX

RADIX      L HHHH HHHH HHHH HHHH

SECTION    DDDD CCCC BBBB AAAA

INPUTS     FB73 FB73 FB73 FB73
           EA62 EA62 EA62 EA62
           D951 D951 D951 D951
           C840 C840 C840 C840

-----
DATA INPUTS      THRESHOLD      POLARITY
DF-D8            TTL      + 1.4      +++++ +++++
D7-D0            TTL      + 1.4      +++++ +++++
CF-C8            TTL      + 1.4      +++++ +++++
C7-C0            TTL      + 1.4      +++++ +++++
BF-B8            TTL      + 1.4      +++++ +++++
B7-B0            TTL      + 1.4      +++++ +++++
AF-A8            TTL      + 1.4      +++++ +++++
A7-A0            TTL      + 1.4      +++++ +++++
CLOCK INPUTS     TTL      + 1.4      +++++ +++++

[F1]→DATA FORMAT, [F2]→TOP THRESHOLD
MEMORY=M MAIN                                MAIN=RDY
0014-4-6
    
```

Figure 4-7. Set Up Main Format Screen

FORMAT SET UP SCREEN (Cont'd)

Data Format Field

The Format Set Up screen is used to specify the display format in the Data Display screen, set the order of channels in the Graph Display screen and set the format used for the pattern definitions in the Trace Control Set Up screen. The Format Set Up screen is called by depressing the FORMAT Set Up key. When called from an initialized state, the screen appears as shown in Figure 4-7. The field adjacent to the words "Data Format" is the active field and contains the word Hex. This indicates the data in the Data Display screen is presented in a fixed hex format. By depressing the NEXT or PREVIOUS keys, the user may scroll through the format choices. He may also make choices using the quick keys as follows:

- (0) Hex - Fixed format
- (1) Octal - Fixed format
- (2) Binary - Fixed format, Sections D through A, inputs 7 through 0
- (3) Binary - Fixed format, sections D and C, inputs F through 0 (not present on 32 input units)
- (4) Binary - Fixed format, sections A and B, inputs F through 0 (not present on 32 input units)
- (5) User Specified - Allows user to specify format arrangement
- (6) Disassembler - Fixed Format, when RTE option is loaded

Level Number Field

The user specified format is initialized to hex. The user may change the format from zero to 40 columns in any radix. The line adjacent to the word "Radix" indicates the radix the user has set up in the corresponding section and input fields. It should be noted that the L element, immediately adjacent to the word "Radix", becomes a field when User Specified format is selected. When active, this field allows the user to specify if the trace level in which each data sample occurred is shown in the Data Display screen. Quick-key selections are as follows:

- (0) No
- (1) Yes

Section Line and Inputs Fields

When the section line is the active field, it should be noted that the field is active on a single character basis. This allows the user to alter the input configuration directly below the character currently active. These characters, A through D, correspond to the input connector pairs (sections) of the connector panel. Each column of data in the Data Display screen can only use inputs from a section of 16 inputs; for example, A (F-0).

FORMAT SET UP SCREEN (Cont'd)

Section Line and Inputs Fields (Cont'd)

The left and right arrow field keys allows the user to select the desired section character field. Normal editing operations can be performed on the selected character, but it should be noted that depression of DELETE causes the character and line definitions below it to be deleted. When the user keys the desired section character into the section line, the active field relocates to the uppermost of seven vertical character fields. The order of bits is determined by the relative position of the input in its column; uppermost input is the most significant bit, and the lowermost input is the least significant bit. Starting with a blank input column, as an entry between F and 0 (7 and 0 for 32 input units) is made in a field, the active field drops down to the next input character location. Simultaneously, the radix character directly above changes to reflect the number of inputs in use in this column. The radix character definitions are given in Table 4-1.

Table 4-1. Radix Definitions

NUMBER OF INPUT CHARACTERS	RADIX LINE CHARACTER	DATA DISPLAY SCREEN RADIX
0		
1	B	BINARY
2	Q	BASE FOUR
3	O	OCTAL
4	H	HEX
5	X	Base 32, values 0-15 are displayed as 0-F 16-31 are displayed as G-V
6	A	ASCII-6
7	A	ASCII-7

When making entries into an input lines column, blanks may be entered anywhere in the column, but the radix adjusts to the number of actual characters present in the column. When all desired entries in a column have been made, use of the right or left arrows of the field keys moves the active field to an adjacent column and up to the section line.

FORMAT SET UP SCREEN (Cont'd)

Threshold Fields

The lower half of the Format Display screen is dedicated to selection of thresholds for each group of eight inputs and polarity for each input. As the user moves the active field down from the last character line of the inputs, the field adjacent to the input group identifier DF-D8 (D7-D0 for 32 input units) becomes the active field. The choices available for this field are as follows:

- (0) TTL
- (1) ECL
- (2) VAR - variable

The adjacent polarity and threshold voltage values of +1.4 for TTL and -1.3 for ECL are fixed values. When Var is selected, the user should note that the polarity and voltage values themselves become fields. For an active polarity field, selections available are +, quick-key (1), and -, quick-key (0). For an active voltage field, numeric keyboard entries from 0.0 to 9.9 may be made giving an effective range of -9.9V to +9.9V. The keyboard entries appear as they are made, in the voltage field shifting from right to left in a manner similar to that in the common hand-held calculator. Any change in polarity or voltage values causes a like change in all polarity or voltage fields.

Polarity Fields

To the right of the threshold values are the selection fields for assigning the polarity for each individual input. Quick-key values are (1) for +, (0) for -. If an input is specified to be negative, the value read in will be inverted prior to presentation in the Data Display, the Graph Display and the value column at the right end of the Timing Display. The Timing Display traces always show a high input as a high and a low input as a low regardless of the polarity selected.

The polarity values are associated with M, A and B data memories. Once a recording has been made, the polarity values cannot be changed. If the polarity of data in memory A is different from the polarity of data in memory B, the data is compared according its polarity.

CLOCKS SET UP SCREEN

Clock Source Field

When the Clocks Set Up screen is called from an initialized condition, the presentation appears as shown in Figure 4-8.

```
                SET UP  MAIN CLOCKS

CLOCK SOURCE   = INTERNAL
MASTER CLOCK   = 50 NANoseconds

MEMORY=M MAIN                                MAIN=RDY
0014-4-7
```

Figure 4-8. Clocks Set Up Screen with Internal Clock Source

The clock source field is the active field. Three choices are available for this field as follows:

- (0) Internal
- (1) External
- (2) External Multi-Phased

When internal clock mode is selected, only two additional fields are present on the screen: the master clock time interval and time unit.

CLOCKS SET UP SCREEN (Cont'd)

Master Clock Time Interval and Time Unit Fields

When the time interval field, the field adjacent to the equals symbol, is active, the user has value choices available as follows:

- (0) - 1
- (1) - 2
- (2) - 5
- (3) - 10
- (4) - 20
- (5) - 50
- (6) - 100
- (7) - 200
- (8) - 500

When the time unit field, the field farthest to the right is active, the user has three choices available as follows:

- (0) milliseconds
- (1) microseconds
- (2) nanoseconds

The user may select values and units within a range of from 50 nanoseconds to 50 milliseconds.

The user should note that of the three set up memories, M, A and B, M is the only one that is alterable. When A or B is selected, the reverse video field indications disappear, and normal video is displayed.

Master Clock Source Field

When the Clock Field is active and the user selects external, the Clocks Set Up screen undergoes a change and appears as shown in Figure 4-9.

Master Clock Source Field (Cont'd)

```

                SET UP  MAIN CLOCKS

CLOCK SOURCE   =  EXTERNAL
MASTER CLOCK   =  SIGNAL 0

-----

EXTERNAL CLOCK COMBINATION DEFINITIONS
NAME:          CLOCK INPUTS:

SIGNAL 0      =  (DJ+DJ+BJ+AJ) + (DK+DK+BK+AK)
SIGNAL 1      =  (DJ+DJ+BJ+AJ) + (DK+DK+BK+AK)
SIGNAL 2      =  (DJ+DJ+BJ+AJ) + (DK+DK+BK+AK)
SIGNAL 3      =  (DJ+DJ+BJ+AJ) + (DK+DK+BK+AK)

MEMORY=M MAIN                                MAIN=RDY
0014-4-8

```

Figure 4-9. Clocks Set Up Screen with External Clock Source

The lower half of the screen provides the user with four lines in which to define external clock expressions. When the Master Clock Source field, the field adjacent to the equals symbol, is active, the user may select any one of the four expressions as the master clock source. He may further elect to use the expression as it is or in an inverted state (clocks on the falling edge). The choices available to the user are as follows:

- (0) Clock source 0, not inverted
- (1) Clock source 0, inverted
- (2) Clock source 1, not inverted
- (3) Clock source 1, inverted
- (4) Clock source 2, not inverted
- (5) Clock source 2, inverted
- (6) Clock source 3, not inverted
- (7) Clock source 3, inverted

CLOCKS SET UP SCREEN (Cont'd)

External Clock Combination Definitions Clock Inputs Field

When the active field is moved down from the Master Clock Source field, the clock input field farthest to the left in the first definition line becomes active. These eight clock input fields refer directly to the two clock input lines on each of the four low order (7-0) probes. The logic expression formed by the eight fields allows the user to AND the J clock inputs in one group, OR the K clock inputs in another group and then OR the two groups. When any of the eight fields is active, the user may make choices as follows:

- (0) No clock input
- (1) Clock input, not inverted
- (2) Clock input, inverted

External Clock Combination Definitions Name

Four clock input definition lines are provided, each uniquely named. The user may make the name field active and change the names as he desires. The name is changed a character at a time by overwriting the existing eight character, maximum, name. Undesired excess characters are removed using the "X"/SPACE key. It is suggested that the user assign unique names to each of the four lines. This eases identification of the line selected for use in the master clock selection field.

Sample/Demux Field

If the user selects External Multi-Phased as the clock source, the screen appears as shown in Figure 4-10.

Sample/Demux Field (Cont'd)

```

                SET UP  MAIN CLOCKS

CLOCK SOURCE   = EXTERNAL MULTI-PHASED
MASTER CLOCK  = SIGNAL 0
-----
SECTION D - SAMPLE ON SIGNAL 0
SECTION C - SAMPLE ON SIGNAL 1
SECTION B - SAMPLE ON SIGNAL 2
SECTION A - SAMPLE ON SIGNAL 3
-----
EXTERNAL CLOCK COMBINATION DEFINITIONS
NAME:          CLOCK INPUTS:
SIGNAL 0      = (DJ+DJ+BJ+AJ) + (DK+CK+BK+AK)
SIGNAL 1      = (DJ+DJ+BJ+AJ) + (DK+CK+BK+AK)
SIGNAL 2      = (DJ+DJ+BJ+AJ) + (DK+CK+BK+AK)
SIGNAL 3      = (DJ+DJ+BJ+AJ) + (DK+CK+BK+AK)

MEMORY=M MAIN                                MAIN=RDY
0014-4-9
    
```

Figure 4-10. Clocks Set Up Screen with External Multi-Phased Clock Source

The four right-hand fields in the center of the screen allow the user to select sample clocks for each of the four channel sections. The selections and functions for these fields are the same as the Master Clock field. The fields adjacent to the words "Section D-" and "Section B-" allow the user to place the K105-D in a demultiplexing mode of operation. The choices for this field are as follows:

- (0) Sample
- (1) Demux

When Sample is selected, each channel section is clocked independently by the clock combination definition chosen in the corresponding right-hand field.

CLOCKS SET UP SCREEN (Cont'd)

Sample/Demux Field (Cont'd)

When Demux is selected, the data inputs of probes B and D become Inoperative, while the clock inputs remain functional. Inputs are made to data channels "A" and/or "C" only. Data is latched from Input A to channel "A" and then to channel "B" and from Input C to channel "C" and then to channel "D". Either one or both inputs may be in demultiplex mode. External clocking is required for this mode.

TRACE CONTROL SET UP SCREEN

General

When the Trace Control Set Up screen is called from an initialized state, the screen appears as shown in Figure 4-10. Because there are a large number of choice combinations possible in this set up screen, the available field choices are presented in Table 4-2.

```

                                SET UP  MAIN TRACE

LVL  COMMAND SEQUENCE:
0:TRACE  UNTIL  SAMPLE = ENABLE
1:TRACE  UNTIL  SAMPLE = TRIGGER
2:LINK ON ENTRY TO LEVEL
  TRACE  FOR   00512 CLOCKS
-----

PATTERN DEFINITIONS:
NAME:      HHHH HHHH HHHH HHHH
00 ENABLE  =XXXX XXXX XXXX XXXX
01 TRIGGER =XXXX XXXX XXXX XXXX
02 _       =XXXX XXXX XXXX XXXX

[F1]→TOP CMD, [F2]→TOP PTRN
MEMORY=M MAIN                                MAIN=RDY
0014-4-10
```

Figure 4-11. Trace Control Set Up Screen

TRACE CONTROL SET UP SCREEN (Cont'd)

The K105-D has eight levels of trace control, each of which can conditionally trace, stop the recording, advance to the next level or jump to another level. These actions can be specified to occur always, never, when sample equals pattern or when sample does not equal pattern. These conditions can also be set to occur only before, on, or after (or any combination of these) the time-out of the delay counter. The delay counter is cleared whenever the level is entered and may be set to count either clocks or occurrences of a data word (known as events delay). Each level may also be set to cause a Link signal which can be used to enable the high speed section and also appears as a rear panel output.

The K105-D trace control is set up from a split-screen display. The upper half of the screen allows the user to set up the trace control using high-level, English-like commands. Each command is translated on entry into a low-level hardware setup, which may involve more than one hardware function. The lower half of the screen is used for defining named data patterns. When a trace control command line specifies that an action be performed when the incoming data matches or fails to match a given pattern, it refers to the data pattern by label.

Set Up Trace

Thirteen lines of trace control and eight lines of pattern definition can be displayed at one time. If more room is needed, either half of the screen can be scrolled. When the active field is moved to the edge of a screen half that has more lines waiting offscreen, that screen half is scrolled to reveal these lines one at a time.

As much as possible, the user is prevented from entering illegal command sequences. NEXT and PREVIOUS keys automatically skip over any choices that result in an illegal setup. Quick-keys that create an illegal condition cause an error message to be displayed and are not accepted.

The INSERT key can be used to insert command lines. The command lines inserted are all 'null' commands, which appear as '-----'. The NEXT or PREVIOUS keys are used to select the desired command. The DELETE key removes commands. If the removal of one command line results in an illegal sequence, the following command lines are deleted until a legal sequence is obtained. All of the deleted command lines may be restored by immediately depressing the F3 soft-key. Depression of any key other than the F3 soft-key causes the deleted lines to be lost.

When the active field is a numeric field, the entire field blinks. The PREVIOUS or NEXT keys can be used to decrement or increment the number, or the decimal keys can be used to key in a new number.

TRACE CONTROL SET UP SCREEN (Cont'd)

Set Up Trace (Cont'd)

When the active field is the pattern name field, pressing NEXT or PREVIOUS selects the next or previous defined name. The user may select the pattern via quick-keys, but he must key in two decimal digits corresponding to the desired pattern number as shown in the pattern definitions portion of the screen.

The two main commands are WAIT and TRACE. Either is followed by a condition which specifies when to proceed to the next action. WAIT causes the instrument to wait for a given condition without recording any data. TRACE causes the instrument to record while waiting for a condition. Table 4-2 lists the various condition choices available to set up the command sequences.

Trace Control Command Descriptions

_____ Blank command line.

WAIT FOR No tracing, wait for specified delay, then advance to next level.

WAIT UNTIL No tracing, wait until condition, then advance to next level.

WAIT ___ No tracing, no advance selected.

TRACE FOR Trace all, advance to next level after specified delay.

TRACE UNTIL Trace all, advance to next level when condition is true.

TRACE IF Trace only when condition is true, no advance selected.

TRACE ___ Trace all, no advance selected.

OR UNTIL

Provides an alternate advance condition by setting up a Jump to the following level. When used at level 7, wraps around to level 0, whereas the normal advance condition stops.

OR GO TO <level> IF

Attaches a Jump condition to the preceding WAIT or TRACE. If the condition is met, the K105-D jumps to selected <level > values on the following master clock. If the Jump condition occurs simultaneously with an Advance condition, the Jump takes priority.

OR STOP IF

Attaches a Stop condition to the preceding WAIT or TRACE command. If the condition is met, the K105-D stops on the following master clock. The Stop condition takes priority over either the Jump or Advance conditions.

TRACE CONTROL SET UP SCREEN (Cont'd)

Trace Control Command Descriptions (Cont'd)

ADVANCE IF

Sets up a condition for advancing to the next command. Available only on the line immediately following "WAIT ___", "TRACE ___" or "TRACE IF", specifying the Advance condition to be attached to this command.

SET DELAY

Sets up the delay count and mode for the level that follows. Delay count can be from 1 to 65535, delay modes are CLOCKS, where the counter is incremented once on every master clock, and "COUNTS OF SAMPLE =", where the counter is incremented once for each sample that matches the selected pattern. Whenever a level is entered, the delay counter is reset to zero. After each delay pattern or clock, the delay counter is incremented by one. If advance on a pattern is used with delay by patterns, the two patterns must match, since the same hardware is used internally.

STOP UPON ENTERING LEVEL

Sets level entry counter for the next level. When this level is entered the specified number (1-4095) of times, the hardware stops immediately.

LINK ON

Sets up the LINK condition for the level that follows.

GO TO <level>

No tracing, jump immediately to selected level.

STOP

No tracing, stop immediately.

Table 4-2. Trace Control Command Format

(0)	----		
(1)	WAIT	(0) FOR (1) UNTIL (2) ---	<delay expression> <condition 1>
(2)	TRACE	(0) FOR (1) UNTIL (3) IF (2) ---	<delay expression> <condition 1> <condition 1>
(3)	OR UNTIL		<condition 1>
(4)	OR GO TO	<level> IF	<condition 1>
(5)	OR STOP IF		<condition 1>
(6)	ADVANCE IF	<condition 1>
(7)	SET DELAY TO		<delay expression>
(8)	STOP UPON ENTERING LEVEL	{1 to 4095}	TIMES
(9)	LINK ON		<condition 2>
(A)	GO TO		<level>
(B)	STOP		
Parameter Definitions			
<delay expression>			
		— {1 to 65535}	(0) CLOCKS (1) COUNTS OF SAMPLE = <pattern>
<condition 1>			
	—	If set-delay not used:	SAMPLE (0) { = } (1) { ≠ } <pattern>
	—	If set delay used:	SAMPLE { = } <pattern>(0) ___ { ≠ } SAMPLE { = } <pattern> (1) { ≠ } AND COUNT <relationship delay> COUNT <relationship> delay
<condition 2>			
	—	(0) ENTRY TO LEVEL (1) ADVANCE OR JUMP (2) JUMP FROM LEVEL (3) ADVANCE FROM LEVEL (4) FIRST TRACE IN LEVEL	
<pattern>			
	—	1 to 8 character pattern name which may contain parenthetically enclosed character fill positions in which substitute values may be entered	
<relationship>			
	—	(0) = , (1) > , (2) ≥ , (3) ≠ , (4) < , (5) <	
<level>			
	—	level number value between 0 and 7	

TRACE CONTROL SET UP SCREEN (Cont'd)

Command Sequence Restrictions

'STOP UPON ENTERING LEVEL' may not be used more than once in a given setup.

The 'OR' commands must follow a WAIT or TRACE. None may be used more than once after a given WAIT or TRACE, and 'OR UNTIL' cannot be used after a WAIT or TRACE that has an 'OR GO TO' command.

'SET DELAY' can be used only once per level before each 'WAIT' or 'TRACE'.

If 'SET DELAY TO <value> COUNTS OF SAMPLE' is used with 'WAIT UNTIL' or 'TRACE UNTIL', the patterns used on both lines must match.

'LINK' can be programmed on each level but executed only once during any arm cycle.

'ADVANCE' can only be used on the line immediately following 'WAIT ---', 'TRACE --' or 'TRACE IF'.

'TRACE FOR' or 'WAIT FOR' can only be used if 'SET DELAY' is not used on the same level.

The conditions involving 'COUNT <relationship> delay' can only be used on a level which uses the 'SET DELAY' command.

Pattern Definitions

The operator may define up to 50 data patterns, eight of which may be displayed at one time in the pattern definition half of the screen. Each definition line consists from left to right of a system-supplied two digit number, the user-supplied name of one to eight ASCII characters, and the pattern value.

A new pattern is defined by moving the active field down to the numbered but undefined line after the last currently defined pattern. When the operator keys in a name for the pattern, the actual value of the symbol is all don't-cares. The active field can be moved to any column of the pattern. Depressing a hex digit appropriate for the radix in use enters that value; depressing the "X"/SPACE key enters a don't-care and PREVIOUS or NEXT rolls the column through its legal values.

TRACE CONTROL SET UP SCREEN (Cont'd)

Pattern Definitions (Cont'd)

Depressing the 'EDIT' key while the active field is on a pattern definition line causes this one pattern to be displayed in a two-dimensional binary representation that is a duplicate of the column definitions in the Format screen. This allows the pattern to be edited on a bit-by-bit basis and makes possible embedded don't-cares. Depressing 'EDIT' again returns the screen to its standard display mode. The user should note that if some but not all bits of a pattern definition column were changed to don't-cares in the Edit mode, then when he views the pattern definitions in the non-edit mode the character for that column is displayed as a small X with a box around it. If all bits for that column are don't-cares, the character displayed in the non-edit mode for that column is a large X.

Depressing 'INSERT' causes the definition currently in the active field to be moved down one position and given the next higher number. The operator can then enter a new pattern name on this line and define a pattern for it.

Depressing 'DELETE' removes the definition in the active field if that definition is not being referenced by an acquisition control line. If it is being referenced, an error message is displayed on line 2. An accidentally deleted pattern may be restored by depressing the F3 soft-key.

If the name of a pattern is changed, the name will also be changed in all referencing trace control lines, so that these control lines will continue to reference that pattern.

When the active field is over a pattern value column, the F4 key can be used to enter a 'fill-in' value in that column. This displays a reverse video underscore at this column and causes the last three characters of the pattern's name field to be replaced with '(_)' . Up to five fill-in columns may be defined for each pattern, in which case the last five characters of the name are replaced with '(_ _ _ _ _)' . The purpose for this is to allow the user to enter different values into these columns each time the pattern is used. When the pattern is selected in the command half of the screen, its name is followed by parentheses surrounding one to five Don't Care characters. The user may replace these Don't Cares with actual values, which are substituted into the pattern at the designated columns.

If the user assigns a value to a pattern definition that has not been previously assigned a name, the K105-D automatically names the pattern. The patterns are named by their location in the sequence of patterns (for example: P06).

Character line 28 of the screen presents definitions of the soft-key functions. These keys, F1 through F4, change functions depending on the screen being viewed. In the Trace Control Set Up screen, F1 moves the active field to the uppermost command line, F2 moves the active field to the uppermost pattern definition, F3 reverses a deletion providing no intervening keyboard entries have been made, and F4 enters fill-in values into pattern definitions.

TRACE CONTROL PARAMETER SETUP REVIEW SCREEN

Once the user has completed a trace control setup, he can review his setup on a level by level basis by accessing the Trace Control Parameter Setup Review Screen, Figure 4-12.

```
TRACE CONTROL PARAMETER SETUP REVIEW

LEVEL 0                               START AT LEVEL 0
DELAY =    0 CLOCKS                   LINK NEVER
TRACE ALWAYS
    T =
ADVANCE IF MAIN = A
    A = XXXX XXXX XXXX XXXX
JUMP TO 0 NEVER
    J =
STOP NEVER
    S =
NO LEVEL ENTRY LIMIT

MEMORY=M MAIN                          MAIN=RDY
0014-4-11
```

Figure 4-12. Trace Control Parameter Setup Review Screen

This screen is selected by depressing the SHIFT key and then the Trace Control key. The screen appears as shown in Figure 4-12 with the Level field active. This field is the only alterable field in the display and allows the user to select specific individual trace levels for review. Selection is made via the NEXT/PREVIOUS key or the numeric keys.

TRACE CONTROL PARAMETER SETUP REVIEW SCREEN (Cont'd)

The trace setup for a level is evaluated and presented on the basis of our commands as follows:

Trace
Advance
Jump
Stop

The condition and pattern are presented for each command. The user should note if he has setup a trace command to act on a given pattern and then later changes the trace command to Trace Always, the Trace Control Parameter Setup Review screen displays a Trace Always Command and the original condition pattern.

The Trace Control Parameter Setup Review screen can only be used to view the Memory M setup conditions. Depressing the A/B key causes the memory select field to indicate that Memory A or B is being displayed; however, the actual parameter displayed is always related to Memory M.

ARM MODE SET UP SCREEN

When the Arm Mode Set Up screen is called from an initialized state, the active field is the Arm Mode : field with MANUAL Mode selected. Depressing the NEXT (or PREVIOUS) key selects the AUTO Mode with additional fields provided for Pass Counter and Auto Compare inputs as shown in Figure 4-13.

ARM MODE

ARM MODE = **AUTO** **AUTO FLUSH**

PASS COUNTER: **NO LIMIT**

AUTO COMPARE: **NO A/B COMPARE**

ARM INPUTS: **MAIN**

MEMORY=M MAIN MAIN=RDY

0014-4-12

Figure 4-13. Arm Mode Set Up Screen with Auto Arm Mode Selected

ARM MODE SET UP SCREEN (Cont'd)

Arm Mode : Field

The Arm Mode : field offers choices of Manual (0) and Auto (1) when active. Manual stops the instrument at the end of one recording cycle. Auto causes the instrument to rearm after the first recording cycle and continue to rearm indefinitely or until modified by the pass counter or stop condition. The STOP key may be used to interrupt Auto Arm mode operation.

Auto Flush Field

Directly to the right of the Arm Mode : field is the Auto Flush field. When active, the Auto Flush field allows the user choices of No Auto Flush (0) and Auto Flush (1). When Auto Flush is selected, data memory M is initialized in its entirety to 0 (lows) prior to the beginning of each recording cycle; in addition, the level counter is set to level 7. This ensures the user will not be viewing data from a prior recording.

Arm Inputs = Field

This field, located directly below the Arm Mode = field, is present only when the high-speed option is installed in the K105-D. Three choices are available as follows:

- (0) Main
- (1) Main & HS
- (2) H.S.

The Arm Inputs = field permits the user to specify those inputs to be armed. When the arm cycle begins, only the selected sections (i.e., Main or H.S.) are armed.

Pass Counter

The user should note that when Auto is selected in the Arm Mode : field, two additional fields appear below the Arm Mode : field. The first of these two fields is the Pass Counter field. When active, this field allows the user choices of No Limit (0) and Limit = <value>(1). If Limit = is chosen, the number of successive recording cycles the instrument makes after the ARM key is depressed is limited. The <value> field, adjacent to Pass Counter Limit =, allows the user to specify a count limit of 1 through 9999 recording cycles.

ARM MODE SET UP SCREEN Cont'd)

Auto Compare Field

The second field, the Auto Compare field, is related to the compare setup fields in the Compare Setup screen. The compare setup fields allow the user to specify parameters for comparison of data in data memories A and B. The manner in which these comparisons are used is determined in the Condition Field and its adjoining field, the Condition Statement field. The Condition Field provides the user with three choices as follows:

- (0) No Compare
- (1) Count <condition statement>
- (2) Stop <condition statement>

When No Compare is selected, the user elects not to use the condition qualifier. When Count or Stop is selected, the Condition Statement field appears. The Count choice causes the unit to count the number of times the condition specified in the Condition Statement field comes true. The Stop choice causes the unit to stop rearming when the condition becomes true. The Stop choice has precedence over the Pass Counter Limit field.

Condition Statement Field

The Condition Statement field states an equal or not equal relationship between the A and B data memories. When the relationship becomes true, the condition is satisfied. When this field is active, the user has choices as follows:

- (0) If Main (A \neq B)
- (1) If Main (A \neq B)
- (2) If main (A \neq B) and HS (A = B)
- (3) If Main (A \neq B) or HS (A = B)
- (4) If H.S. (A \neq B)
- (5) If H.S. (A \neq B)

The Arm Inputs field and the Condition Statement field are closely linked. If a change in the Arm Inputs field causes the Condition Statement to no longer be valid, the Condition Statement changes to a valid option.

AUTO COMPARE SET UP SCREEN

When the SHIFT and COMPARE keys are sequentially depressed, the Auto Compare Set Up Screen is selected. Figure 4-14 illustrates the Auto Compare Set Up Screen.

```

                SET UP  AUTO COMPARE

COMPARE MAIN INPUTS SELECTED ON THE FORMAT SCREEN
STARTING AT SAMPLE 0000
FOR 1023 SAMPLES (MAXIMUM SAMPLES = 1023).

-----

COMPARE H. S. INPUTS SELECTED ON THE FORMAT SCREEN
STARTING AT SAMPLE 0000
FOR 1024 SAMPLES (MAXIMUM SAMPLES = 1024).

-----

                AUTO EDGE TOLERANCE

TOLERANCE: ±0 MAIN SAMPLES AND ±0 H. S. SAMPLES

EDGE TOLERANCE IS ASSOCIATED WITH MEMORY B AND IS
SET ON EACH A→B DATA TRANSFER OR BY PRESSING [F1]

MEMORY=M MAIN                                MAIN=RDY
0014-4-25
```

Figure 4-14. Auto Compare Set Up Screen

Main Inputs Comparison Fields

The Auto Compare Set Up screen is dedicated to compare setups. In addition to being related to the Condition field, this screen is also related to the Compare mode of the Data Display screen by depressing the PREVIOUS key. The upper fields of the screen allow the user to enter a starting point for comparisons of the main inputs memory A and the main inputs memory B. The range of values that can be entered into these fields must fall between 0 and the desired number of samples -1. The For <value> Samples field allows the user to specify the number of samples in which comparisons will occur. When this field is active, a decimal value may be entered.

The ability to set different comparison starting points for data memories A and B provides an offset of comparisons when viewed on the Data Display screen. For example:

```
MEM-A STARTING AT 0100
MEM-B STARTING AT 0105
FOR 0100 SAMPLE(S)
```

AUTO COMPARE SET UP SCREEN Cont'd)

With the example setup, when A and B memory data comparisons are made viewing data memory A of the Data Display screen, the comparisons begin at location 100 and continue for 100 samples. If the comparisons are made viewing data memory B of the Data Display screen, the comparisons begin at location 105 and continue for 100 samples.

Main Inputs Selection Fields

The Main Inputs Selection fields allow the user to specify those inputs that are to be included in comparisons. For 32 input units, four field blocks are displayed, and for 64 input units, eight field blocks are displayed. When a field block is accessed, the input fields become active on an individual basis. The user may choose to omit an input from the comparison by selecting _ (0), or may include an input by selecting ✓ (1).

High-Speed Inputs Compare Set Up

The high-speed inputs may be setup for comparisons by following the same procedures that apply for the main inputs. For those units not equipped with high-speed inputs, the Compare H.S. Inputs Information does not appear on the screen.

Auto Edge Tolerance Fields

The Auto Edge Tolerance fields in the lower portion of the screen allow the user to specify don't-cares for a given number of samples on each side of a transition. The don't-cares are associated with data memory B and are visible when viewing the memory B Data Display and Timing Display screens.

The tolerance is entered by making the desired value field active and entering a value of 0 to 9. 0 represents all do-cares. The value is then transferred to the B data memory on the next A to B data transfer or upon depression of the F1 soft-key.

If the unit has no high-speed inputs installed, the H.S. Inputs = field does not appear on the screen.

HIGH SPEED SET UP SCREEN

The previously described screens have dealt with setup of the main inputs. To view or perform setups of high-speed screens, the user must depress the MAIN/HS key. As previously described, the Main/HS display element changes to HS. Once the user has accessed the high-speed screens from an initialized state, depression of any one of the FORMAT, CLOCKS or TRACE CONTROL keys calls the High Speed Set Up screen. The screen appears as shown in Figure 4-15 with the left-most character of the Sequence line active.

```

                                SET UP  HIGH SPEED                                MAIN/HS

RADIX:      B B B B B B B B
SEQUENCE:   7 6 5 4 3 2 1 0

TRIGGER:    IF        
            BECOMES  TRUE  & REMAINS TRUE FOR  21  SAMPLES
            THEN STOP AFTER  00500  CLOCKS

-----

CLOCK

SOURCE =  INTERNAL

CLOCK  10  NANoseconds

INPUT MODE =  SAMPLE

-----

                                THRESHOLDS          POLARITY

INPUTS 7-0    TTL + 1.4           ++++  ++++
HJ, HK       TTL + 1.4

-----

MEMORY=M HS                                MAIN=RDY
0014-4-13
```

Figure 4-15. Set Up High Speed Screen

HIGH SPEED SET UP SCREEN (Cont'd)

Sequence Fields

The High Speed Set Up screen incorporates some features of the Main Format and Clocks Set Up screens. Because of these common features, the user should find the High Speed Set Up screen somewhat familiar and easy to configure. The Radix line displays are similar to those listed in Table 4-1. The Sequence line allows the user to select the order and radix for displaying the High Speed inputs in the Trigger Word field and on the Data Display screen. The Sequence field has 31 columns, in which the user may enter any sequence of input numbers and spaces. On powerup, this field contains all installed High Speed inputs arranged from highest number to lowest, each separated with a single space. The spaces serve to separate the inputs into groups, with each group corresponding to a single column on the Data Display screen. Groups that contain only one input are displayed in binary radix. Groups containing four inputs are displayed in hexadecimal; groups containing three inputs are displayed in octal and groups containing seven inputs are displayed in ASCII. In all cases, the leftmost input in the group is the most significant bit, and the rightmost input in the group is the least significant bit.

Link Field

The Link Field, located in upper-right corner of the screen, allows the high-speed inputs to operate in conjunction with the main inputs. When this field is active, the user has choices of Linked (0) or Not Linked (1).

Three conditions must exist in the setup of the K105-D for the high-speed inputs to be linked to the main inputs:

1. The Link command must be present in the trace control setup.
2. Main & HS must be selected in the Arm Sections field of the Arm Mode Set Up screen.
3. Link must be selected in the Link Field of the High Speed Set Up screen.

When the Link command is encountered during the main inputs trace operation, the high-speed inputs are enabled to look for a trigger. Upon recognition of the trigger, the high-speed inputs continue to acquire data for the duration specified in the delay fields, then the recording stops.

If the high-speed inputs are operated in a non-linked mode, they start looking for a trigger as soon as they are armed.

Trigger Word Field

The Trigger Word fields, located directly below the Sequence fields, permit the user to define the high-speed inputs trigger word.

Trigger Field

When active, this field permits the user to elect to trigger the high-speed inputs on either data True (1) or data False (0).

The Sequence and Trigger Word fields are directly related, and when either is changed, both are redisplayed.

The K105-D high-speed inputs are edge-triggered. When the high-speed inputs are not linked to main inputs trace control and the data word is set to all don't-cares, high-speed triggers immediately.

Filter Field

The Filter is the number of consecutive samples that must match the trigger word in order to start the delay counter. Legal values are 1 through 14 when this field is active.

Delay Value Field

The Delay Value is the number of clocks or events that must occur from the trigger until the end of the record cycle. Legal values are 1 through 65,535 when this field is active.

Delay Mode Field

When active, the Delay Mode field allows the user to specify if the delay will be counted in Clocks (0) or Events (1). If Events is selected, occurrences of the trigger word is counted.

In setting up the delay value, it is possible to pass through illegal values. This only causes an error message to be displayed on line 2 if the user attempts to leave the delay value field while it is set to an illegal value.

Clock Source Field

When this field is active, the user can select a clock source of Internal (0) or External (1).

HIGH SPEED SET UP SCREEN (Cont'd)

Clock Interval and Clock Decade Fields

When an Internal Clock Source is selected, these fields are present directly below the Clock Source field. When active, the clock Interval field allows entries as follows:

- (0) - 1
- (1) - 2
- (2) - 5
- (3) - 10
- (4) - 20
- (5) - 50
- (6) - 100
- (7) - 200
- (8) - 500

When the Clock Decade field is active, the user may make selections as follows:

- (0) - milliseconds
- (1) - microseconds
- (2) - nanoseconds

The user may enter values within a range of from 10 nanoseconds to 50 milliseconds.

Clock Fields

When External Clock Source is selected, the external clock fields are present rather than the Clock Interval and Clock Decade fields.

Using external clocks, the clock expression is the result of two signal inputs, HJ and HK. When active, either of these fields allow choices as follows:

- (0) - HJ (or HK) - rising edge
- (1) - $\overline{\text{HJ}}$ (or $\overline{\text{HK}}$) - falling edge
- (2) - ___ - Ignored

These two clock signals are AND'ed together.

Input Mode Field

Both the internal and external clock sources allow for two data input modes. When active, the Input Mode field allows the user choices of Sample (0) or Glitch (1). In sample mode, data inputs are checked on the active clock edge. In glitch mode, any asynchronous threshold crossing between clocks is stored as the next data sample. If no threshold crossings occur between sample clocks, data held is the same as if the K105-D were in sample mode.

Thresholds and Polarity Fields

Although the high-speed inputs have fewer sections than the main inputs, the setup of the thresholds and polarity is the same. When any of the Thresholds fields is active, the user has choices as follows:

- (0) - TTL - preset to +1.4V
- (1) - ECL - preset to -1.3V
- (2) - VAR - variable from -9.9V to +9.9V

The settings for the variable range are accomplished in the same manner as with the variable range in the Main Format Set Up screen. The user should note that the K105-D has only one variable voltage; therefore, changing the high-speed inputs variable threshold alters the main inputs threshold.

Polarity Fields

Polarity of each input may be individually defined and is indicated by a plus (+) for positive (1) and a minus (-) for negative (0).

DATA DISPLAY SCREEN

The Data Display screen, Figure 4-16, is called by depressing the DATA key. This screen provides a display of the recorded data interpreted as numeric or ASCII values. The format of the data for the main inputs Data Display screen is selected in the main inputs Format Set Up screen; the data format for the high-speed Data Display screen is determined by the fields in the High Speed Format Set Up screen.

```
DISPLAY MAIN DATA          CLK= 50 nSEC

SEARCH = X  XXXX  XXXX  XXXX  XXXX
          L  HHHH  HHHH  HHHH  HHHH
C 0000    0 0000 0000 0000 0000
 0001    0 0101 0101 0101 0101
 0002    0 0202 0202 0202 0202
 0003    0 0303 0303 0303 0303
 0004    0 0404 0404 0404 0404
 0005    0 0505 0505 0505 0505
 0006    0 0606 0606 0606 0606
 0007    0 0707 0707 0707 0707
 0008    0 0808 0808 0808 0808
 0009    0 0909 0909 0909 0909
 0010    0 0A0A 0A0A 0A0A 0A0A
 0011    0 0B0B 0B0B 0B0B 0B0B
 0012    0 0C0C 0C0C 0C0C 0C0C
 0013    0 0D0D 0D0D 0D0D 0D0D
 0014    0 0E0E 0E0E 0E0E 0E0E
 0015    0 0F0F 0F0F 0F0F 0F0F
 0016    0 1010 1010 1010 1010
 0017    0 1111 1111 1111 1111
 0018    0 1212 1212 1212 1212
 0019    0 1313 1313 1313 1313
 0020    0 1414 1414 1414 1414

CONTROL=0000      REF=1023      R-C=+1023 (51.15 nS)
[F1]=PAGE UP, [F2]=PAGE DOWN - USE EDIT TO CHANGE SEARCH
MEMORY=A MAIN      PASS=0000      MAIN=RDY
0014-4-14
```

Figure 4-16. Data Display Screen

The data displayed can be that of the A data memory, which represents data taken during the last recording. The displayed data can also be that of the B data memory, which could contain data placed there for reference. The user is able to alternately select either of these two screens by depressing the A/B key. When the K105-D is initialized, the B data memory is filled with a data test pattern. When the user wishes to store A memory data, he must depress the A --> B key, the shifted function of the A/B key.

DATA DISPLAY SCREEN (Cont'd)

The K105-D displays 21 to 63 memory samples on the screen depending on the number of inputs available on the unit and the radix selected in the Format Set Up screen. Reading from left to right, each sample line is displayed with a space for the 'C' (control) or 'R' (reference) tag followed by a four-digit sample number. Following the sample number, a space is reserved for tags generated by the search (*) or compare (≠) functions. To the right of this space a space is available for an optional one digit level number character followed by up to 40 characters of recorded data. The radix of each data character column is displayed in character row four.

The Data Display screen C and R tags and the respective Timing Display screen cursor and reference vertical lines are interactive. For a change made to one in a given screen, there is an equal change to its counterpart in another screen. When the Data Display screen is selected, the first data line displayed is the line at the C tag. The following samples lines appear underneath this one, forming a column of samples. Each column consists of 21 samples, and up to three columns may be displayed.

To manually move the C or R tag, the desired tag is selected by depressing the CONTROL or REF key, respectively. The tag can then be moved up or down using the ↑ (up) or ↓ (down) arrow keys. When the C tag is moved, it always remains in the leftmost column of samples. When the C tag is at the bottom of the data column and an attempt is made to move the tag further down, the data samples scroll up while the C tag remains stationary. Similarly, an attempt to move the C tag up when the tag is at the uppermost sample line causes the samples to scroll down. The R tag may be moved to any position on or off screen. When moving the R tag in areas off screen, the user can monitor the R tag location via the REF = display element in character line 27 of the screen.

The C tag may also be moved by depressing the Page Up (F1) or Page Down (F2) function keys. These keys cause the C tag to move up or down by 21 Samples, completely regenerating the display. When viewing the main data, NEXT or PREVIOUS moves the C tag to the next or previous level transition. When viewing high speed data, depressing the NEXT and PREVIOUS keys will move the C tag to the trigger position.

The C tag may be set by first depressing the SHIFT key and then the CONTROL key. The desired position value is controlled via the 0 through 9 keys. Depressing the CONTROL key again enters the value. If the new position of the C tag is still in the leftmost column of samples, only the C tag is moved; otherwise, the screen is regenerated with the C tag at the third uppermost sample line. The R tag is similarly set by depressing the SHIFT key and the REF key, but the screen is never regenerated.

Data Display Screen - Edit Mode

The Data Display screen has a search word displayed at the top of the leftmost column of samples. When the Edit key is depressed, the Search word is changed to reverse video and the active field appears at its leftmost column. (See Figure 4-17.)

DATA DISPLAY SCREEN (Cont'd)

Data Display Screen - Edit Mode (Cont'd)

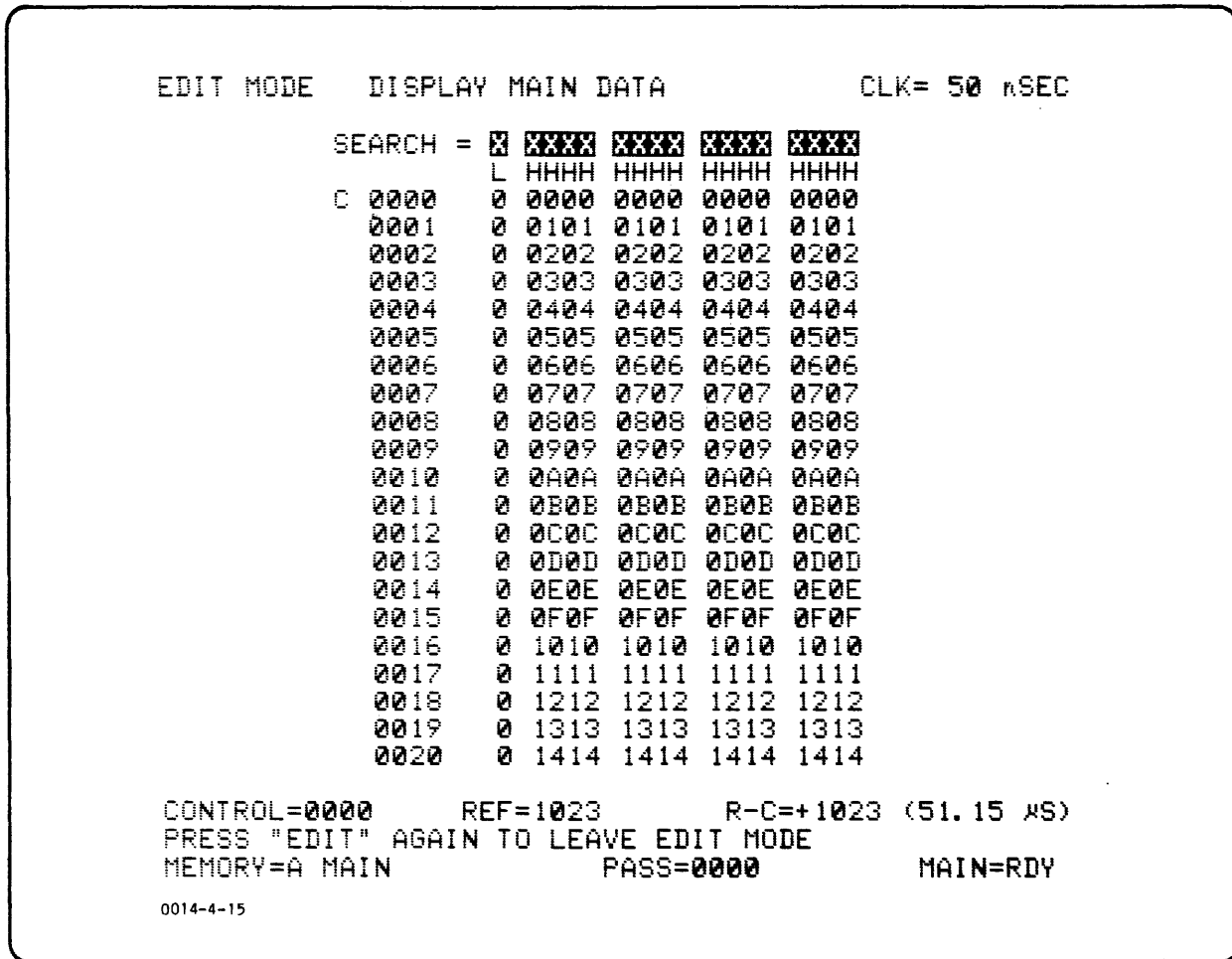

Figure 4-17. Data Display Screen In Edit Mode

The hex keys, NEXT, PREVIOUS and 'X' can be used to select a search value. Once set up, edit mode is left by depressing the EDIT key again. Pressing the SEARCH key causes the K105-D to search the entire memory buffer for all samples that match the selected search value. Any samples currently on the screen that match the search value are tagged with an asterisk. A summary line appears near the bottom of the screen, showing the total number of matching samples and the sample numbers of the first and last match. The NEXT or PREVIOUS keys can be used to move the C tag to start at the next or previous block of matching samples.

DATA DISPLAY SCREEN (Cont'd)

Data Display Screen - Edit Mode (Cont'd)

When in edit mode with memory B selected, the active field can be moved down from the search word field into the recorded data display. Here the hex keys can be used to enter new values into the B memory. Depressing the 'X' key enters a value of "don't-care". Attempting to move the blinking cursor past the bottommost sample in the first column causes the data to scroll up one position. This scrolling may cause the 'C' tag to be moved off the screen. This is the only case in which that can happen. Leaving edit mode with the screen scrolled in this manner causes the screen to be regenerated to its original position.

The contents of memory A can be compared with the contents of memory B by depressing the 'Compare' key. Any samples that are not identical (except for don't-care bits) are tagged with a not-equals sign. A summary line is displayed near the bottom of the screen, showing the total number of samples that are not equal, and the first and last non equal samples. These items are displayed in the same places that the search information is displayed; therefore, search and compare are mutually exclusive. Requesting either function causes the other function to be disabled if it was active. The NEXT or PREVIOUS keys may be used to move the C tag to the start of the next or previous block at not-equal samples.

The user should note that if a skewed comparison has been selected in the Arm Mode Set Up screen, the samples tagged are different in data memories A and B. For example, if the Arm Mode Set Up screen has been setup as:

```
MEM-A STARTING AT 0003
MEM-B STARTING AT 0005
FOR 0010 SAMPLE(S)
```

then samples 3 through 13 in data memory A are compared with samples 5 through 15 in data memory B. If sample 3 in A does not match sample 5 in B, but all others match, then the Data Display screen tags sample 3 when viewing memory A and sample 5 when viewing memory B.

TIMING DISPLAY SCREEN

The Timing Display screen, Figure 4-18, presents the recorded data of from up to 16 data inputs as idealized oscilloscope traces. Two different Timing Display screens are available: main inputs (sections A-D) and high-speed inputs (section H).

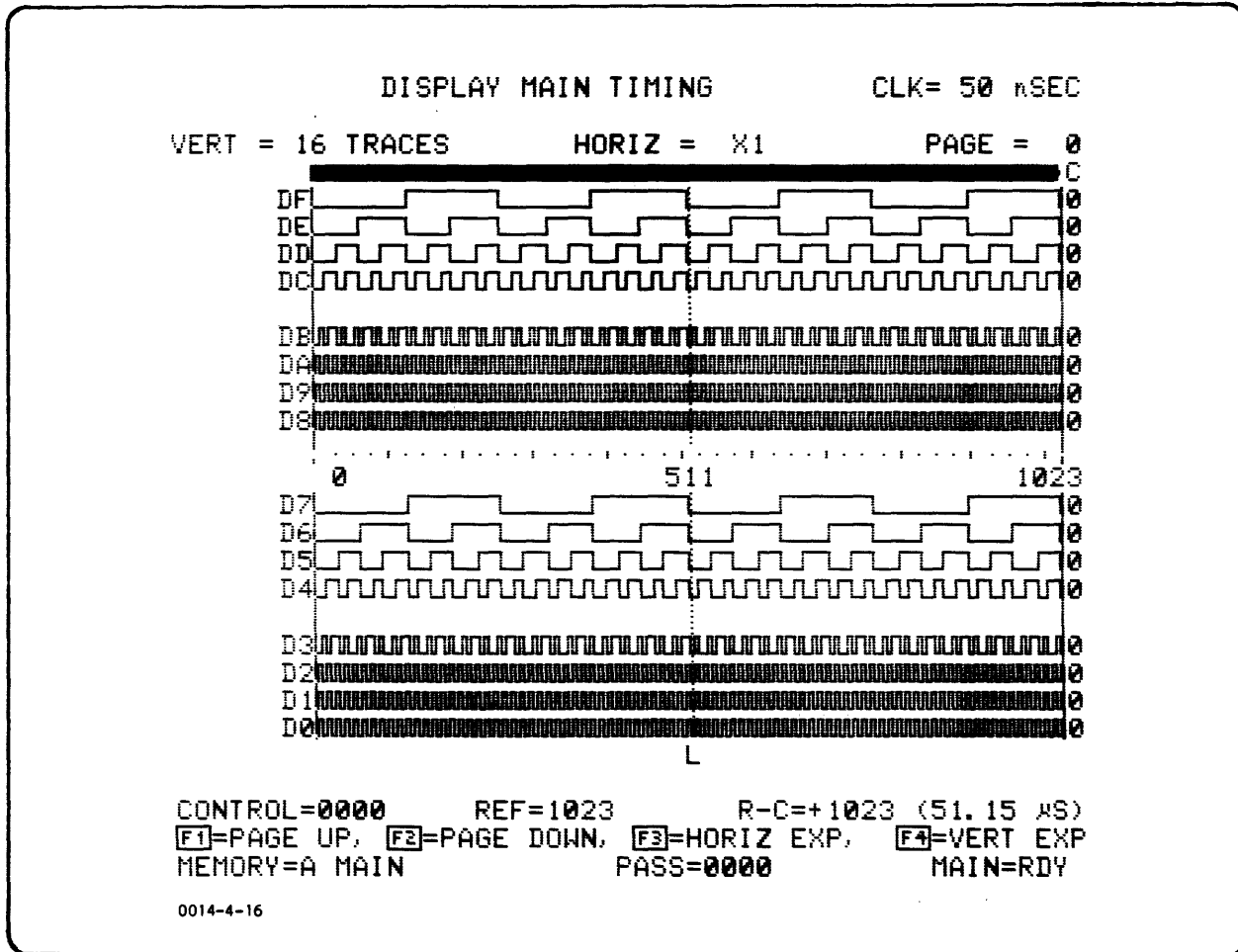

Figure 4-18. Main Inputs Timing Display Screen

The Timing Display screen consists of a header on character line one, a display of current expansion settings on character line three, up to 16 timing traces and a control and reference location readout on character line 27. Once the Timing Display screen has been accessed, the user may depress the EDIT key and assign five-character labels to the left edges of all traces. These labels are initialized to all blanks and are separated from the two-character input identifiers by a blank. The user may enter a five-character name in the specific field, possibly the mnemonic of the signal being displayed for this trace. This label remains attached to the trace input regardless of any future input sequence changes. The two-character input identifiers consist of a section character (D through A) followed by the input line number (F-0). Next is the trace itself which occupies 43 character columns. To the right of the trace is a readout of the value of the trace under the cursor or reference, whichever was moved last. This readout takes into account the selected polarity of the input,

TIMING DISPLAY SCREEN (Cont'd)

while the trace always displays a recorded 1 as high and a 0 as low, regardless of selected polarity.

The traces may be displayed in one of four possible horizontal expansions: 'x1', 'x6', 'x12', 'x24'. In 'x1' the recorded data is compressed by a factor of six, so that all 1024 samples fit on the screen. In compressed mode, each point on the screen is generated by looking at the next six samples. If any one of these samples is different from the last point displayed, the next point displayed is the opposite of the last point. This ensures that single sample glitches are always displayed. Since a six to one compression is referred to as 'x1', a one to one display of the data must be called 'x6'. Expansion by two and four are also provided; these must be labeled 'x12' and 'x24' respectively. In all expansions except 'x1', not all data fit on the screen. To make it possible to view any part of the data, the left edge of the timing traces start at the sample under the 'C' cursor, as long as the right edge of the traces is not past the end of the recorded data buffer.

When the Timing Display screen is first accessed, the traces are presented in an 'X1' mode. Successive depressions of the F3 soft-key select the different expansion modes in order of their magnitude with a rollover from the 'X24' to 'X1' modes.

The user should note that when in the 'X1' expansion mode, the entirety of character line four is illuminated. This illuminated stripe represents the 1024 word recording buffer. When expansion modes 'X6' through 'X24' are selected, the illuminated stripe narrows in width, and when the cursor is moved in these expanded modes, the remaining portion of the illuminated stripe moves. The movable illuminated stripe represents the portion of the recording buffer being viewed in the expanded modes. The position along character line four of the movable illuminated stripe represents the location within the buffer of the portion being viewed.

There are also three possible vertical expansions that can be used: 'V16', 'V8', 'V4', in which sixteen, eight or four traces are displayed at once. In the main input Timing Display screen, there is an input sequence table with 128 entries. This table is divided up into 'pages' of four traces each. The page being displayed can be changed using the 'Page Up' and 'Page Down' soft-keys, 'F1' and 'F2', respectively. Page 0 can be selected by entering SHIFT-F1.

The height of each trace is determined by the vertical expansion as follows:

TRACES	NUMBER OF PAGES ON SCREEN
16	4
8	2
4	1

Selection of the different vertical expansion modes is made using the F4 soft-key in a manner similar to selecting the horizontal expansion modes.

TIMING DISPLAY SCREEN (Cont'd)

Timing Display Screen - Edit Mode

The Timing screen has an edit mode that is used for the following: changing the trace labels, resequencing the traces and altering the data in the B memory. Edit mode is entered by depressing the EDIT key. In edit mode, the trace labels and input IDs are displayed in reverse video. The active field appears at the topmost input ID.

Inputs can be resequenced by moving the active field to input ID fields and keying in new input numbers. In the main-inputs screen, these consist of the hex characters 'A'-'D' followed by '0'-'F'. When the first character is entered, the trace area is cleared. The active field cannot be moved until the second digit is entered. In the high-speed screen, the inputs are selected simply by entering '0'-'F'. The NEXT or PREVIOUS keys may also be used to change inputs. The SPACE key may be used to remove inputs from the screen. Note that removing inputs will not increase the vertical expansion.

Input labels may be set by moving the active field to the desired column. The characters 'Space', '0'-'9' and 'A'-'F' may be entered directly from the hex pad. Hex pad entry causes the active field to move right one position. The other characters, 'G'-'Z' are entered via shifted hex pad keys. The function keys 'F1'-'F4' enter the characters '+', '-', '*', '/', respectively.

If in memory B (memory select can be changed while in Edit mode), the active field can be moved into the trace area and used as an editing cursor. Here, it becomes narrow and slightly taller than one trace. The number of the sample under the editing cursor is displayed at the bottom of the screen. The right arrow and left arrow keys can be used to move the cursor to any desired position. Data values of '0' or '1' can be keyed in directly. Don't-cares can also be keyed in, using the "X" key. These appear as cross-hatched areas.

GRAPH DISPLAY SCREEN

The K105-D Graph Display screen, Figure 4-19, plots the recorded data samples as a graph, with position on the y-axis determined by the value of the recorded sample and position on the x-axis determined by the sample number. The screen is entered by pressing the GRAPH key.

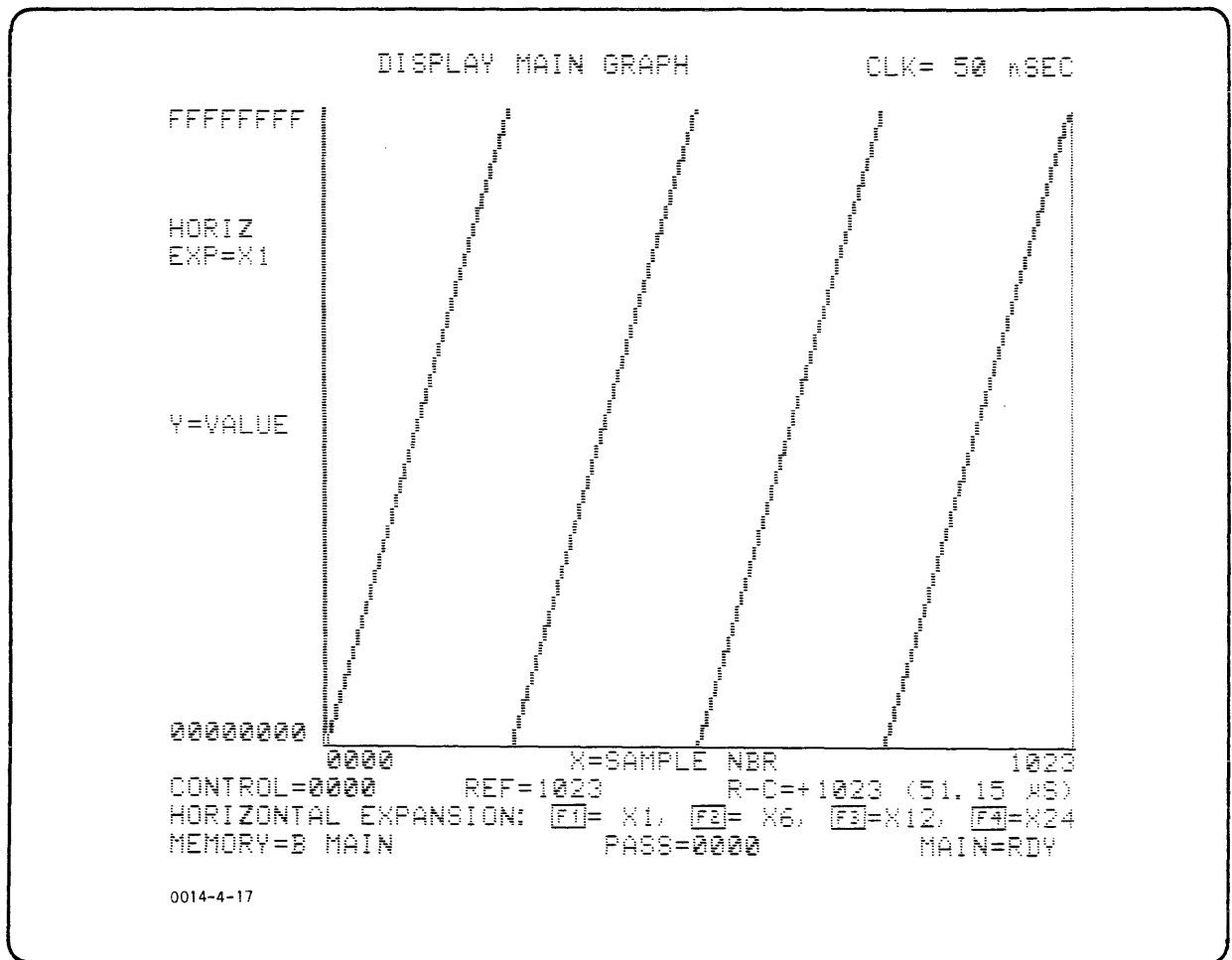

Figure 4-19. Graph Display Screen

Upon selecting the Graph Display Screen, the user may depress the EDIT key, and the upper and lower limit values become fields. The leftmost character of the upper limit field is the active field. By using the right and left arrows and the hex key-pad, the user may edit the upper limit to some new value. The user can then depress the down arrow to make the leftmost character of the lower limit field the active field. The editing procedure for the lower limit is the same as that for the upper limit. The limits are always displayed in hex to conserve room on the CRT. When the new limits have been entered, pressing 'EDIT' again restores the limit fields to normal video and causes the graph to be regenerated using the new limits.

GRAPH DISPLAY SCREEN (Cont'd)

Upon selecting this screen, the currently selected memory (A or B, MAIN or HS) is plotted out. For each point to be plotted, the sample at that point is converted up to a 32-bit value. For the main inputs, this is done by reordering the bits according to the sequence of inputs selected in the Format Set Up screen. For the high-speed inputs, the ordering sequence will be determined by the sequence field on the HS Setup screen. In either case, the data bits are inverted as necessary to reflect their selected polarities.

Once a 32-bit value is obtained, it is compared against the upper and lower limits selected here in the Graph Display screen. If out of range, a point is plotted at either the topmost or bottommost scanline. If in range, the correct position relative to the limits is determined, and the point is plotted.

Only 230 scanlines are available for the graph display, so the resolution is slightly less than 8 bits. To expand the graph vertically, closer limits must be selected. Horizontally, only 172-bit positions are used. The 'x1' expansion displays six samples on each column. The 'x6' expansion displays one sample on each column, so only 172 samples are shown. In 'x12' and 'x24', only 86 and 43 samples are displayed. Horizontal expansion is selected via the soft-keys, F1-F4.

MAIN PERFORMANCE ANALYSIS SCREEN

The Main Performance Analysis screen, Figure 4-20, allows the user to select either of two analysis display screens; the Time Interval Histogram Display screen and the Noise Margin Analysis Display screen. The Main Performance Analysis screen is entered by depressing the ANALYSIS key. Further selection is made by depressing the F1 key for the Time Interval Histogram Display screen or the F2 key for the Noise Margin Analysis screen.

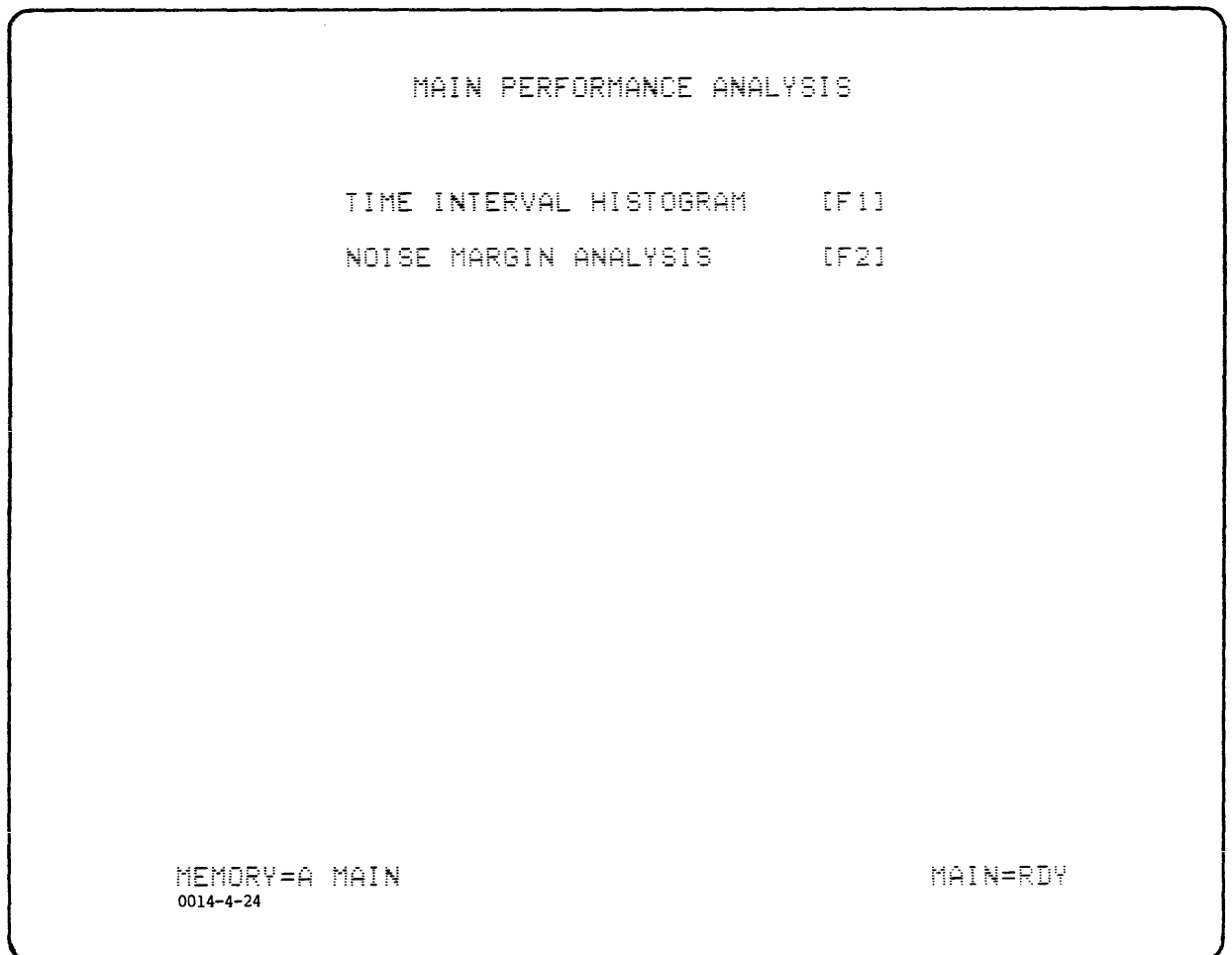

Figure 4-20. Main Performance Analysis Screen

NOISE MARGIN ANALYSIS

Noise margin analysis is a feature unique to the K105-D. This feature permits analyses and a graphic display of system signal ranges, showing noise overshoot conditions. This is accomplished by taking successive recordings while varying the thresholds on the inputs under analysis. At the end of each recording, the captured data is compared against a reference recording stored in the B data memory and qualified by the don't-care memory. Inputs that do not match at one or more of the 1024 sample locations fail at this threshold level. The results of the successive recordings are displayed as a matrix with one column for each input under test and one row for each threshold voltage. Each element of the matrix displays either an illuminated box (passed) or an "X" (failed).

Noise Margin Analysis Preparation

For main inputs analysis, trace control should be programmed to yield consistent results over repeated recordings. The clock threshold and the inputs used to control the trace sequence should be fixed (TTL or ECL). Inputs used in the trace program must not be selected for noise margin analysis.

For high-speed inputs analysis, trace control for the main inputs should be programmed to provide consistent results over repeated recordings. All main inputs, including the clocks, must be set to a fixed threshold. The Link command should be used in the main trace sequence. When setting up high-speed inputs, inputs 7-0 should control the trigger. Trigger condition for high-speed inputs F-8 should be set to don't-care. Thresholds for the high-speed inputs 7-0 and the high-speed clocks should be fixed. Linked should be selected in the High Speed Set Up screen.

To verify trace setup stability, the input sections (MAIN or MAIN and HS) that need to be armed should be selected on the arm mode screen. The inputs that control the flow of the trace should be selected for data memory A to data memory B compare. If the high-speed inputs are selected for the noise margin analysis, the high-speed inputs 7-0 should be selected for data memory A to data memory B compare.

To check trace setup proceed as follows:

- Program trace control
- Take trace recording, move data to data memory B
- Take trace recording, compare data memory A to data memory B
- Recordings match?
True - double check by doing at least one more recording and compare
False - revise trace control program; take recordings and compare memories until successive recordings match.

Noise Margin Analysis Setup

The Noise Margin Analysis Display screen appears as shown in Figure 4-21 with the Analyze Inputs field active.

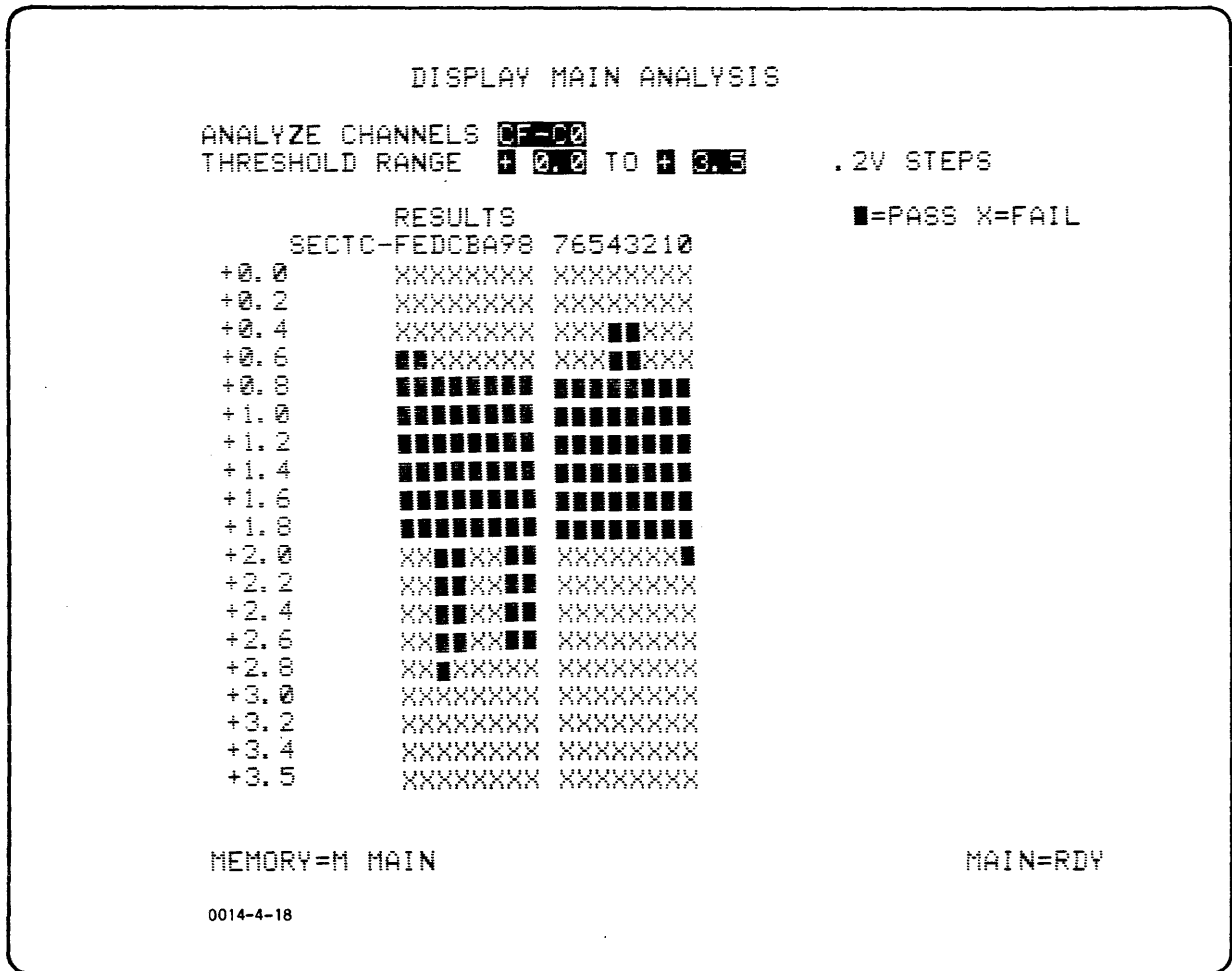

Figure 4-21. Display Main Analysis Screen

Depending on the number of inputs available in a specific K105-D, analysis may be performed in groups of 8, 16 or 32 inputs. The Analyze Inputs field, when active, allows the following choices:

32 Main Inputs Units

- (0) A(7-0)
- (1) B(7-0)
- (2) C(7-0)
- (3) D(7-0)

NOISE MARGIN ANALYSIS (Cont'd)

Noise Margin Analysis Setup (Cont'd)

64 Main Inputs Units

(0) A(7-0)	(8) A(F-0)
(1) B(7-0)	(9) B(F-0)
(2) C(7-0)	(A) C(F-0)
(3) D(7-0)	(B) D(F-0)
(4) A(F-8)	(C) BF-A0
(5) B(F-8)	(D) CF-B0
(6) C(F-8)	(E) DF-C0
(7) D(F-8)	

High-speed noise analysis may be performed only with those units having 16 high-speed inputs. Because inputs F-8 are preselected, they are the only inputs allowed for high-speed noise analysis.

When the Threshold Range Field is active, the user may select a range of -9.9V to +9.9V. The range may proceed from low to high or vice versa. The step size needed to cover the range (in 21 or less recordings) is automatically calculated. The smallest step size is 0.1V, and the largest step size is 1.0V. In the threshold fields, the decimal point is fixed. When a key is entered, the current digits are shifted left to make room for the new digit. Illegal values are not accepted.

The first recording cycle is initiated when the user presses the ARM key. For the first recording, the variable threshold is set to the beginning of the threshold range. At each subsequent recording the variable threshold is changed by the step size until the variable threshold equals the end of the threshold range.

Interpreting Analysis Data

Noise analysis recordings are not transferred to data memory A. Instead, at the end of each record cycle, data memory M samples for the inputs selected are compared to data memory B samples for the same inputs. Results are displayed in a Input/Threshold table. Columns are assigned input labels, and the variable threshold values become the row labels. When all 1024 samples for an input are the same in both memories, a "pass" character is displayed. "Fail" indicates that one or more samples for the input did not match.

Results of the noise margin analysis are not stored. Results of the last noise analysis recording series are lost when a new recording series is initiated or the user exits the analysis screen. The screen is locked while a recording series is in progress. The STOP key terminates a noise analysis recording series.

NOISE MARGIN ANALYSIS (Cont'd)

Interpreting Analysis Data (Cont'd)

The user should note that the probes are active devices and may introduce some error into the waveshape seen by the logic analyzer. The user should avoid quantifying absolute noise levels except in fixed, calibrated installations.

PERCENT VERSUS TIME HISTOGRAM DISPLAY SCREEN

Because the K105-D is monitoring signal levels or code from an external source, the target system, the time the trace remains in a given trace level varies from one recording cycle (pass) to the next. By means of the Time Interval Histogram display, the K105-D totals all time that the trace is in a specified level or levels during a given number of passes and presents a graph depicting the percentages of this total time that the trace remains in the specified level(s) for various time intervals. Figure 4-22 illustrates a typical Time Interval Histogram.

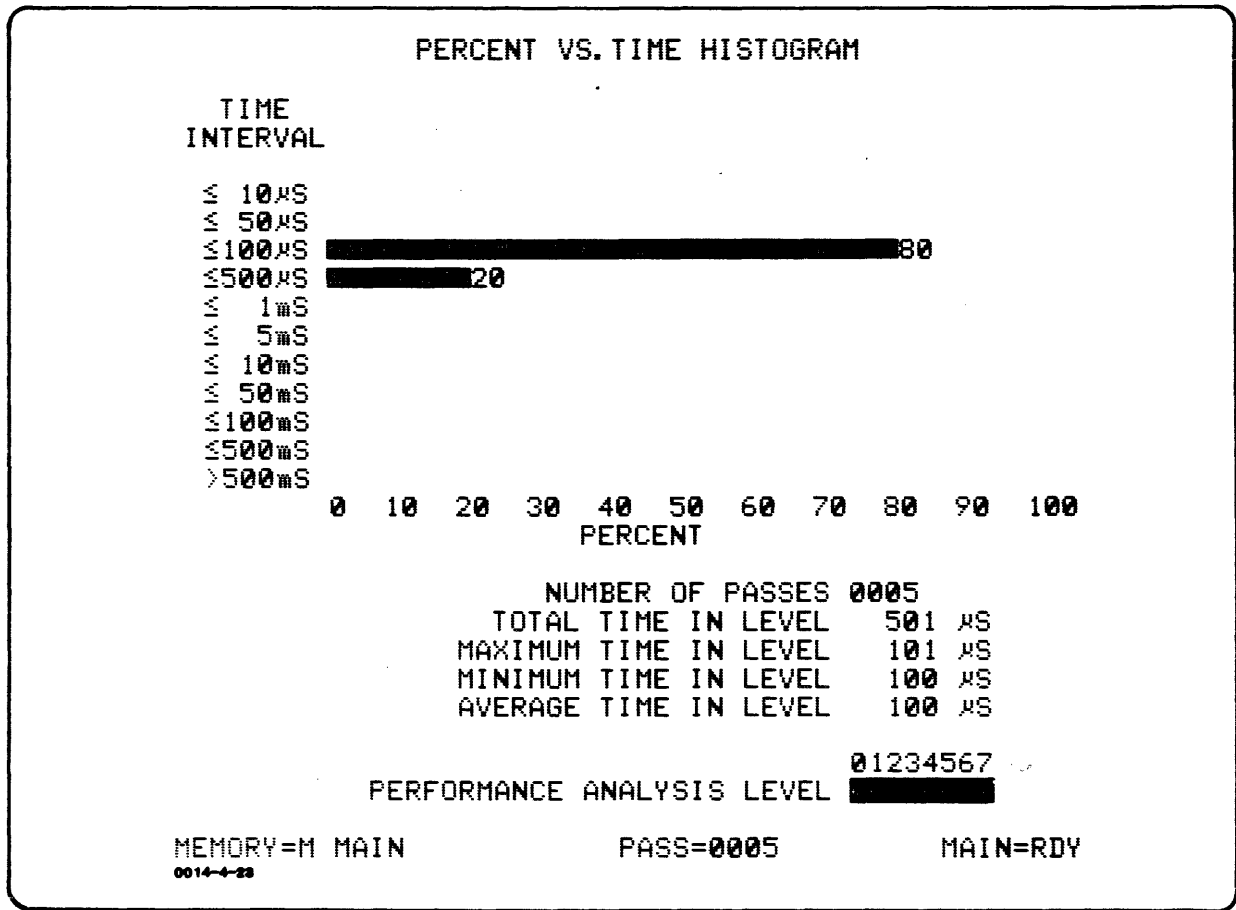

Figure 4-22. Time Interval Histogram Display Screen

The Arm Mode must be set to Auto and the number of desired passes must be specified in the Arm Mode Setup screen. To run a Histogram, the trace must be armed while viewing the Time Interval Histogram Display screen.

Performance Analysis Level Field

The performance Analysis Level Field allows the user to select the level or levels for which the histogram is plotted. The level number is indicated above the field, and a level is selected by placing a " " below the level number (quick-key 1) or deselected by placing "-" below the level number (quick-key 0). The default level selection is level two.

I/O FUNCTION SELECTIONS

Depression of the I/O key accesses an I/O Function menu, as shown in Figure 4-23. Eight quick-key choices allow interaction with peripheral equipment attached to the K105-D which allow the user to select a particular I/O function. The following I/O functions are selected by depressing the corresponding numeric keys:

- (0) Disk Quick Mode - Allows keyboard inputs for disk operations while viewing setup or display screens.
- (1) Disk Screen Mode - Selects Disk Directory Screen.
- (2) I/O Setup Screen - Selects I/O Setup Screen for configuring the I/O ports.
- (3) GPIB-SRQ - Causes the K105-D to set the GPIB SRQ line active.
- (4) Print Screen Direct - Causes the K105-D to send the visible portion of the screen presently displayed to the host or terminal.
- (5) Print Screen Long - Causes the K105-D to send all information for a given screen to the host or terminal.
- (6) Send Setup Records - Causes the K105-D to send all setup records.
- (7) Send Memory Records - Causes the K105-D to send the corresponding record(s) for the current memory as follows:

<u>MEMORY</u>	<u>RECORD SENT</u>
Main A or M	--> MA,LA
Main B	--> MB,MX,LB
HSA or HSM	--> HA
HSB	--> HB,HX

- (8) Print Graphics - Causes the K105-D to send the exact bit mapped graphics display to an *EPSON FX-80, or equivalent printer. Graphics mode is valid for any screen, but is especially useful for printing timing charts and other graphic screens.

I/O FUNCTION SELECTIONS (Cont'd)

```

                DISPLAY MAIN DATA                CLK= 50 nSEC

SEARCH = X XXXX XXXX XXXX XXXX
        L HHHH HHHH HHHH HHHH
C 0000      0 0000 0000 0000 0000
  0001      0 0101 0101 0101 0101
  0002      0 0202 0202 0202 0202
  0003      0 0303 0303 0303 0303
  0004      0 0404 0404 0404 0404
  0005      0 0505 0505 0505 0505
  0006      0 0606 0606 0606 0606
  0007      0 0707 0707 0707 0707
  0008      0 0808 0808 0808 0808
  0009      0 0909 0909 0909 0909
  0010      0 0A0A 0A0A 0A0A 0A0A
  0011      0 0B0B 0B0B 0B0B 0B0B
  0012      0 0C0C 0C0C 0C0C 0C0C
  0013      0 0D0D 0D0D 0D0D 0D0D
  0014      0 0E0E 0E0E 0E0E 0E0E
  0015      0 0F0F 0F0F 0F0F 0F0F
  0016      0 1010 1010 1010 1010
  0017      0 1111 1111 1111 1111
  0018      0 1212 1212 1212 1212
-----
I/O FUNCTIONS:      [4]=PRINT SCREEN DIRECT
 [0]=DISK QUICK MODE [5]=PRINT SCREEN LONG
 [1]=DISK SCREEN MODE [6]=SEND SETUP RECORDS
 [2]=I/O SETUP SCREEN [7]=SEND MEMORY RECORDS
                       [8]=PRINT SCREEN GRAPHICS
-----
MEMORY=A MAIN                                MAIN=RDY

```

Figure 4-23. I/O Function Menu

The user should note that the number of choices available depends on the configuration of the K105-D and the I/O mode in which it is operating.

I/O SETUP SCREEN

When viewing the I/O menu, the user can access the I/O Setup screen by depressing the 2 key. The I/O Setup screen appears as shown in Figure 4-24 and allows the user to configure the I/O ports to suit his particular application.

```

                                     I/O
                                     -----
                GPIB                      RS232
MODE              = LSTN ONLY          BAUD RATE       = 1200
GPIB ADDR.       = 07                  WORD LENGTH    = 7 BITS
TERMINATOR       = CR/LF              STOP BIT(S)    = 1
EOI OUTPUT       = OFF                PARITY         = NONE
                                           PROTOCOL      = XON/XOFF
-----
I/O - PORT       = GPIB
RECORD LENGTH    = 80 CHARS.
-----

GPIB STATE = LOCS, LA      SRQ = INACTIVE
[F1]→MODE FIELD, [F2]→BAUD FIELD
MEMORY=A MAIN                                MAIN=RDY
```

Figure 4-24. I/O Setup Screen

The screen is divided into three portions as follows:

- Upper Left Portion - For use in configuring the GPIB port.
- Upper Right Portion - For use in configuring the RS232C port.
- Lower Portion - Active port selection.

When the I/O Setup Screen is first accessed, the GPIB Mode = field is active. The GPIB mode is a default which can be changed by the user to present the RS-232-C mode as described in subsequent paragraphs (see I/O Port = Field).

I/O SETUP SCREEN (Cont'd)

Mode = Field

This field permits the user to select a Talk Only, Listen Only or a Talk/Listen mode of operation for the GPIB. When this field is active, the user has the following soft-key choices:

- (0) Talk Only
- (1) Listen Only
- (2) Talk/Listen

GPIB Address = Field

When active, this field allows the user to assign a two-digit GPIB address to the K105-D. Legal values are 00 through 30. The default address is 07.

Terminator = Field

When this field is active, the user can define the end-of-line delimiter as follows:

- (0) CR/LF
- (1) CR

EOL Output = Field

When active, this field allows the user to disable (0) or enable (1) the End or Identify GPIB line. When enabled, the EOL line is forced true as the last data byte is sent.

Baud Rate = Field

This field permits the user to set the RS232-C communications rate. When this field is active, the user has the following baud rate choices:

- | | |
|----------|-----------|
| (0) 110 | (5) 1800 |
| (1) 150 | (6) 2400 |
| (2) 300 | (7) 4800 |
| (3) 600 | (8) 9600 |
| (4) 1200 | (9) 19200 |

Word Length = Field

When this field is active, the user may select a word length of seven bits (0) or eight bits (1).

Stop Bit(s) = Field

When active, this field allows the user to configure the protocol for one stop bit (0) or two stop bits (1).

Parity = Field

The Parity = field allows parity choices as follows:

- (0) None
- (1) Even
- (2) Odd

Protocol = Field

When active, the Protocol = field permits protocol choices of XON/XOFF (0) and RTS/CTS (1).

I/O Port = Field

When this field is active, the user can select communication through the RS232-C port (0) or the GPIB port (1). When the GPIB port is chosen, the only other field available in this section of the display is Character Length =. If the RS232-C port or GPIB Talk Only mode is chosen, a third field, Command =, appears.

The default state of this field is the GPIB mode. To change the default state to the RS-232-C mode, the user must remove the Data Display printed circuit board and add a jumper connector wire across S1 as indicated in Figure 4-25.

Record Length = Field

This field, when active, allows the user to specify record lengths of 80 characters (0) or an unlimited number of characters (1) to be sent from the K105-D.

Command = Field

This field is displayed when GPIB or RS232-C is chosen and Talk Only mode is selected. When active, this field permits the user to specify the information to be sent from the K105-D. Upon selection of the record type(s) depression of the F3 key causes the information to be transmitted. This is the only field that has no soft-key choices; the record type must be selected by stepping through choices with the NEXT/PREVIOUS keys. Depression of the 0 key returns the field to the home position of Send All Setup. The following selections are provided:

- | | |
|-------------------------------|---------------------------------------|
| - Send All Setup | - Send MB, MX, LB |
| - Send Clock Setup | - Send MS, MV, ML, MT, MQ, MG, MC, MR |
| - Send Format Setup | - Send All High Speed Data |
| - Send Trace Control Setup | - Send HA |
| - Send Arm Mode Setup | - Send HB, HX |
| - Send Auto Compare Setup | - Send HS, HL, HT, HQ, HG, HC, HR |
| - Send Noise Marg Anal Setup | - Send Search Data |
| - Send High Speed Setup | - Send Configuration |
| - Send All Main Channel Setup | - Send Status |
| - Send MA, LA | |

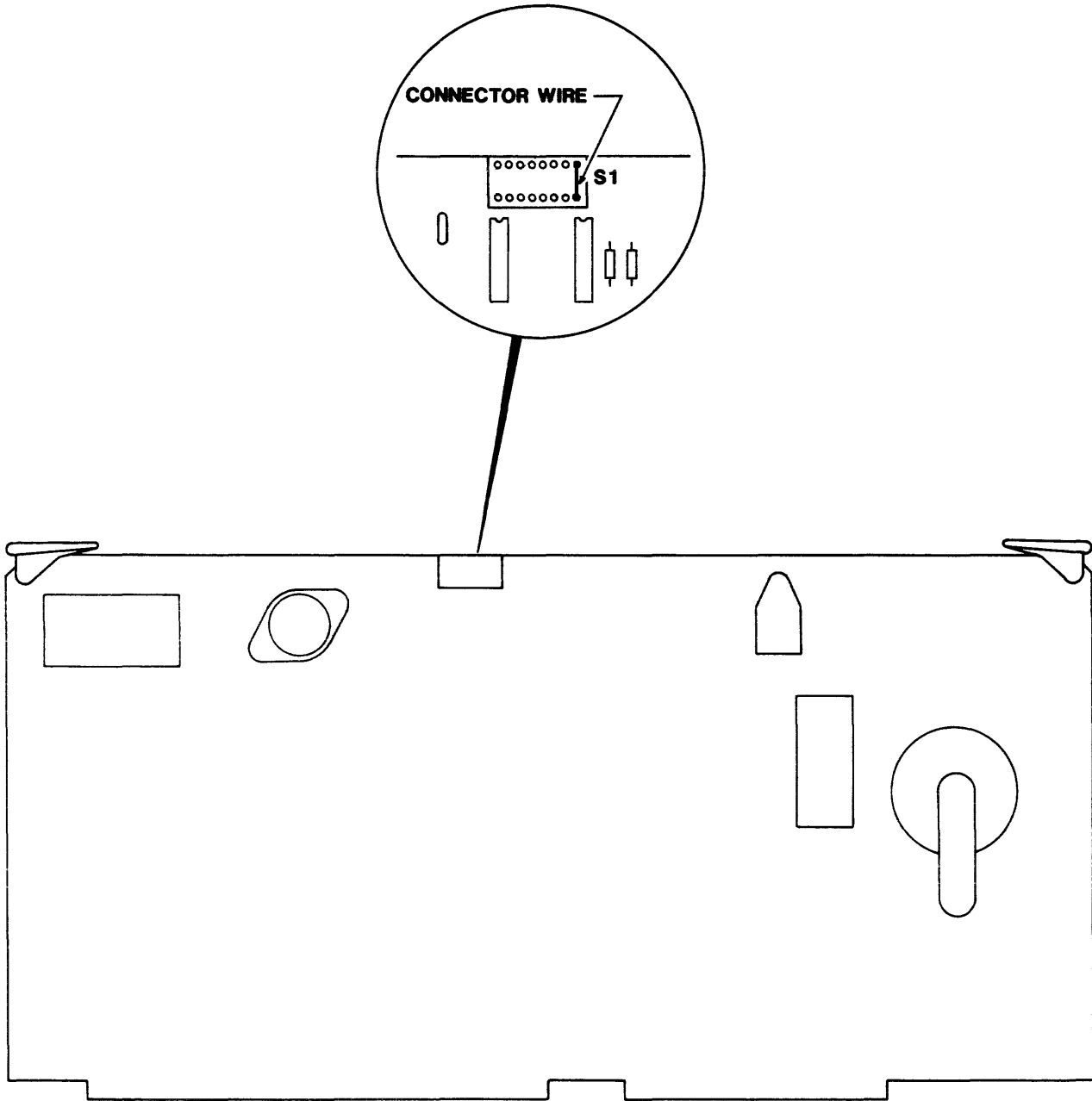

004-A-1

Figure 4-25. Component Side of Data Display Board

INTERFACE

The K105-D can communicate with a variety of other instruments, computers, and peripherals. This section contains the specific information needed to operate the K105-D over two interfaces: the IEEE STD 488-1978 and EIA-RS-232-C. The IEEE STD 488-1978 is an 8-bit parallel interface, commonly referred to as the General Purpose Instrumentation Bus (GPIB). The EIA-RS-232-C is an asynchronous bit serial interface.

The specific mechanical, electrical, and functional characteristics and standards of the GPIB and RS-232-C are explained in detail in the following references.

GPIB

1. IEEE Standard Digital Interface for Programmable Instrumentation (IEEE STD 488-1978). Osborne/McGraw-Hill.
2. Pet and the IEEE-488 Bus. E. Fisher & C. Jensen. Osborne/McGraw-Hill, 1980.
3. Articles in Microcomputing, July, 1980; Electronic Test, April, 1981.
4. "IEEE-488: Its Impact on the Design, Building and Programming of Automatic Test and Measurement Systems" by David W. Ricci, Hewlett-Packard. Presented at ELECTRO '80, Session 3: IEEE-488 User Fundamentals, May 13-15, 1980, Boston, MA.

RS-232-C

1. EIA Standard, Interface between DTE and DCE, RS-232-C.
2. EIA, Application Notes for RS-232-C Standard (Bulletins 9 & 12).
3. CCITT Series V Recommendations.
4. Data sheets and application notes of various Data Communication chips.
5. Digital, Technical Aspects of Data Communication, J. McNamara.
6. Data Communication Handbook, A. Weissberger.

GPIB INTERFACE DESCRIPTION

The K105-D GPIB Interface is an implementation of the IEEE 488-1978 published November 30, 1978, under the title "IEEE Standard Digital Interface for Programmable Instrumentation." This implementation supports the capabilities and electrical interface as defined by that standard. Table 4-3 lists the K105-D GPIB Interface capabilities.

Table 4-3. GPIB Interface Capabilities

Source Handshake	(SH1)	Complete Capability
Acceptor Handshake	(AH1)	Complete Capability
Talker Function	(T5)	Basic Talker Talk Only Unaddress if 'MLA'
Talker Function with Address Extension	(TE0)	No Capability
Listener Function	(L3)	Basic Listener Listen Only Unaddress if 'MLA'
Listener Function with Address Extension	(LE0)	No Capability
Service Request	(SR1)	Complete Capability
Remote Local Function	(RL1)	Complete Capability
Parallel Poll Function	(PP1)	Remote Configuration
Device Clear Function	(DC1)	Complete Capability
Device Trigger Function	(DT0)	No Capability (Unsupported)
Controller Function	(C0)	No Capability

GPIB INTERFACE CONNECTION

A female connector labeled IEEE 488 is provided on the rear connector panel of the K105-D. Connect one end of the GPIB cable to this connector and the other end to a controller or to another K105-D. The instrument can be operated locally or from a remote station.

GPIB INTERFACE MODE

The first field in the GPIB interface section of the I/O Setup screen is designed for interface mode selection. The K105-D can be configured to operate in one of the following three interface modes (the default condition for the interface mode is Listen Only):

1. Talk and Listen
2. Talk Only
3. Listen Only

Talk and Listen Mode

In this mode the K105-D accepts information from, as well as transfers information to, a controller. This mode is used in most applications because it is best suited to control the instrument from a controller. To use Talk and Listen mode, assign an address between 0 and 30 in decimal to the instrument.

The K105-D processes records sent on the GPIB bus when addressed to listen. The K105-D can also be addressed to talk. In that case, the instrument processes records and sends the necessary information back to the controller.

IFC Command

The IFC Command, sent via the IFC line, clears the K105-D GPIB and sets the Talk and Listen states to idle.

Device Trigger and Device Clear Commands

The Device Trigger and Device Clear commands, multiwire messages, reset the K105-D to the wakeup screen with all parameters set to the power-up default condition.

Talk Only Mode

The foremost application of Talk Only mode is the transfer of information to a dedicated GPIB printer to provide hard copies of setup screens, timing diagrams, or memory.

Talk Only mode is also used to transfer setups and/or contents of memory A or B to another K105-D.

Listen Only Mode

Like Talk Only mode, Listen Only mode has limited use; it is used to receive information from another K105-D. The default condition for the K105-D is Listen Only mode. This condition permits users to remotely change the K105-D talk/listen mode since it always receives and processes records in Listen Only; for example, the user can change the instrument to Talk and Listen mode.

TERMINATION CHARACTERS

Because the K105-D can be configured to accept any of four termination strings, the unit has flexibility to adapt to any controller. For example, some controller must receive Carriage Return only. Others may require both Carriage Return and Line Feed to terminate a record. The four termination strings are:

1. CR and LF
2. CR&LF + EOI
3. CR
4. CR + EOI

GPIB STATUS BYTE

By using the KT command as described in Chapter 5 or by issuing a serial poll command, the user may read the GPIB Status Byte. The bits of the Status Byte have the following meaning:

<u>Bit</u>	<u>Meaning</u>
7	Recording in progress (armed but not stopped).
6	SRQ - K-105 requests service.
5	Error in powerup diagnostics.
4	Listen Record error, rest of record ignored.
3	Interface error has occurred: No listeners active.
2	Acquisition control error. (ARM control)
1	Not used (always zero)
0	Not used (always zero)

RS-232-C

This interface is provided for applications where the K105-D is remotely controlled using modems and telephone lines. The RS-232-C interface can also be used to connect the K105-D to a local peripheral, such as a printer, to provide hard copies of setup screens and graphics data. The interface characteristics can be selected in the I/O Setup screen. The K105-D is configured as a Data Terminal Equipment (DTE).

PROTOCOLS

The modem control lines are used to control an asynchronous modem. The RTS/CTS handshake is used to synchronize two devices with different processing speeds. This feature protects the internal buffer from overflowing with received characters. The K105-D uses the DTR (Data Terminal Ready) signal to indicate the imminent buffer overflow; thus you must stop sending data until this signal is released. The K105-D on the other hand ceases transmission if the CTS (Clear To Send) signal goes false.

Many computers and peripherals use XOFF/XON (DC3/DC1, control S/control Q in ASCII table) protocol to synchronize their data exchange. The K105-D has implemented this software protocol. When the K105-D can only accept a few more characters, it sends an XOFF character (CTRL/S) to signal that it needs time to empty and process the input buffer. The XON character in turn indicates that the K105-D is ready to accept more data. If the K105-D receives an XOFF character, it does not transmit information until it receives an XON.

RS-232-C INTERFACE CONNECTION

One female connector labeled RS-232-C is provided on the rear connector panel K105-D. To access the K105-D from a remote location, simply connect the K105-D to a modem or an acoustic coupler with an RS-232-C cable. The cable should have male connectors on both ends. The instrument can also be connected to various computers and computer peripherals. Most computer peripherals operate as DTE, indicated by a female connector in the back. Pins 2 and 3 wires in the cable have to be interchanged in one connector to transfer signals properly. This is essentially an implementation of the null modem. The user can arrange one of the following three configurations when a modem or acoustic coupler is not used. The following configurations can be used to connect the K105-D locally with another DTE such as a CRT terminal.

The Null Modem

The user might want to use the simple circuit shown in Figure 4-26 which, however, does not have handshake capabilities.

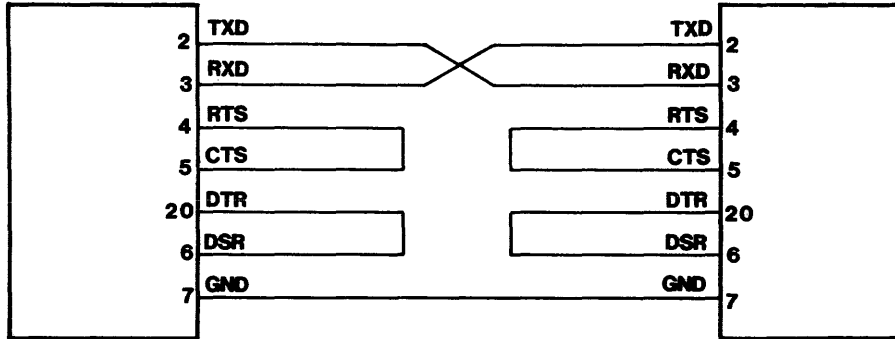

0014-4-26

Figure 4-26. Simple Null Modem Wiring Diagram

Another possible solution of an easy wiring configuration is shown in Figure 4-27. This circuit allows logic handshaking by means of the DTR/DSR lines.

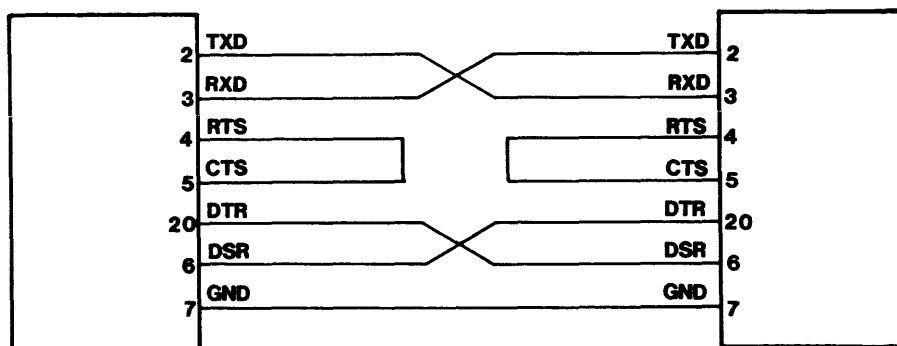

0014-4-27

Figure 4-27. Null Modem Wiring Diagram with DTR/DSR

The interconnection shown in Figure 4-28 is a complete arrangement to interconnect the K105-D to any computer using the earlier described hardware handshake capabilities.

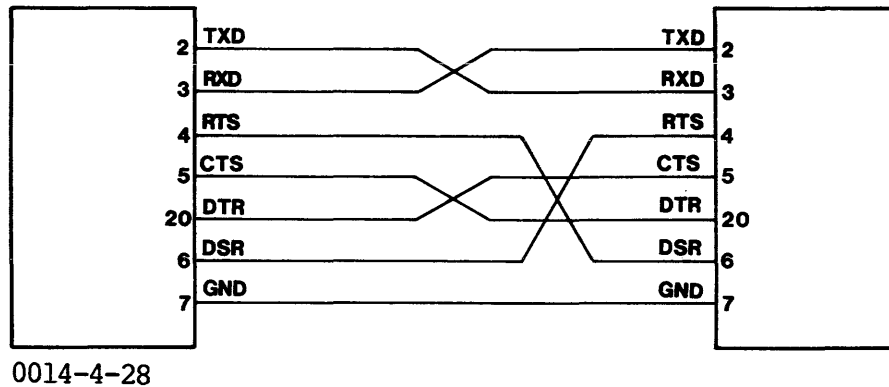

Figure 4-28. Complete Null Modem

The wiring connections shown in Figure 4-29, interconnect the K105-D to the *Epson FX-80 Dot Matrix Printer.

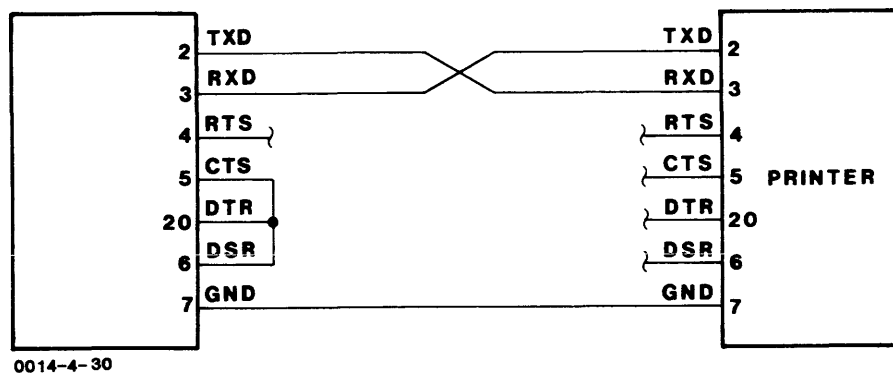

Figure 4-29. Null Modem for Epson Printer

Example Use of Printer for Graphics Printout

The following procedure presents steps for printing a graphics screen to the Epson FX-80 printer via the RS-232 port. Note that K105-D Software Rev. 3.4 or greater must be present for this application. Verify AC power is removed from both units prior to connecting the modem.

1. Connect the Epson FX-80 printer unit to the K105-D, using the null modem diagram shown in Figure 4-28.
2. Power up the K105-D and Printer Units. Access the I/O Set Up Screen and set the following RS-232 controls for identical conditions on both the printer and K105-D units.

Baud Rate	9,600 BPS
Word Length	8 Bits
Stop Bits	1 or 2
Parity	Disable
Protocol	XON/XOFF

3. Enter the Graphics Screen and depress the I/O key. A prompt appears at the bottom of the display screen which indicates the print function is enabled.
4. Depress the #8 key (Print Graphics) to execute the print function.

INTERFACING TWO K105-D's

Two K105-D's easily interface to each other, but if one unit is a 32-input unit and the other a 64-input unit, then in order to view all 64 columns of data on the 32-input unit, the user must setup the 32-input unit remotely from the 64-input unit.

INPUT/OUTPUT OPERATIONS

GENERAL

Input/Output operations are initiated by accessing the I/O Function Menu Display to select the desired type of I/O transfer, and then accessing the I/O Setup Display to execute the transfer operation. These I/O displays and setup requirements are described at the end of Chapter 4, along with details of GPIB and RS-232 interfacing requirements.

This chapter presents the K105-D Record Types. Each Record Type description explains the syntax, procedures and system response.

It is strongly recommended that the user become familiar with I/O Interfacing and Setup in chapter 4, prior to attempting remote operation of the K105-D.

RECORD TYPES

The following three types of GPIB/RS232 records can be used when operating the K105-D.

Request Record - Requests the instrument to return a setup record.

Setup - If sent to a K105-D, a setup record commands the instrument to change a record. If sent back from the K105-D, a setup record indicates the value of the parameter. The setup record functions are complimentary and can both be performed for one operation.

Command - A record type that can be only sent, with no response from the K105-D.

Data records may be divided into scalar records, in which a single value is sent, and array records, in which one or more values may be sent. All records are transmitted as ASCII characters and begin with a two-character record identifier. For all screen setup records, however, the two-character record identifier may be preceded by a Memory Indicator, either "A" or "B". If the Memory Indicator is absent, the memory defaults to Memory "M". For data array records, the record identifier must be followed by a range specification, which consists of parenthesis containing the range. Scalar Data identifiers may not be followed by parenthesis.

In the case of scalar records (and array records when range is specified), a record identifier followed by (end of the line) (CR/LF or CR) is a request for data from the K105-D. A record identifier followed by an equal sign is a data setup record, which contains new data for the K105-D.

A superscript numeral outside an entry enclosed in braces indicates the amount of times the selected entry must be sent; the total amount of entries can consist of a combination of desired entries.

NOTE: NA = Not applicable when it appears under a heading in a record type.

Send All Record Types

The Send All record types, following each record type section, send a complete listing of all Setup records associated with the selected record category.

CONVENTIONS FOR COMMAND SYNTAX

[] - Square brackets, which must not be entered, indicate optional entries.

{ } - Braces, which must not be entered, indicate required entries.

() - Parenthesis enclosing an index must be included when the specified entry is sent.

<A/B> - Memories A or B can be selected for setup data by prefixing the letter 'A' or 'B'. If omitted, Memory M will be used.

Command Categories

The Record Types are alphabetically ordered by function name, rather than the actual command name.

INVALID RECORDS

The K105-D's response to invalid records or data depends on which communication port, RS-232 or GPIB, is active.

RS-232

When RS-232 is active and the K105-D receives an invalid record type or data, the K105-D sends the following "Invalid Record" message:

```
end-of-line "IR=*** INVALID RECORD ***" end-of-line
```

The K105-D then discards the remaining portion of the received record and scans the input until an end-of-line message is received. If the K105-D itself receives the "IR" record, it sends an end-of-line message. When a data record is received and processed, the K105-D responds with an end-of-line message if data is valid; otherwise, the "Invalid Record" is sent. The K105-D accepts and ignores any number of end-of-line messages and accepts either CR or CR/LF as the end-of-line message. The K105-D, however, always sends CR/LF as the end-of-line message. If the K105-D receives an end-of-text character (Ctrl-C, 03H), it immediately cancels the command processing and waits for a new record-identifier.

The maximum record length can be selected on the I/O setup screen to be either 80 characters or unlimited. This capability is useful when the output is sent to a printer or CRT. The K105-D batches up all received records and processes them sequentially.

GPIB

When GPIB is active and the K105-D receives an invalid record type or data, it performs the following:

- a) The K105-D sets bit 4 (listen record error) in the GPIB status byte and then sends an SRQ-message to the controller.
- b) The K105-D discards the rest of the received record and scans the input until an end-of-line message is received.

If the K105-D itself receives an "Invalid Record", it accepts and ignores the record (i.e., no response is sent back). When a data record has been received and processed, the K105-D does not respond if data is valid; otherwise, bit 4 is set in the GPIB status byte and a SRQ-message is sent to the controller. The K105-D accepts any number of end-of-line messages. For each end-of-line message received the K105-D sends back a line-feed character. The K105-D accepts either CR or CR/LF as the end-of-line message. The K105-D, however, always sends the end-of-line message selected on the I/O setup screen (either CR or CR/LF).

If the K105-D receives an end-of-text character (Ctrl-C, 03H), it immediately cancels the command processing and waits for a new record-identifier. The maximum record length can be selected on the I/O setup screen to be either 80 characters or unlimited. This capability is useful when the output is sent to a printer or CRT. The K105-D batches all received records and processes them sequentially.

RANGE SPECIFICATIONS

The following presents the range specifications for sending array-record types. Note that the index range affects the number of times data to the right of the equal sign must be sent, (e.g., if the range is (0-3), data must be entered four times). In the case of the colon, however, data can be entered only once.

The brackets below indicate required entries:

1. $\left\{ \text{index} \right\}$

Only one array value is sent/received.

Example: (0) (5) (456) . . .

2. ($\{\text{lower}\} - \{\text{upper}\}$)

All values in the range are sent/received in ascending order.

This is a FIXED format. The number of data items must match the range specification.

Example: (0-2) (5-123) (999-1023) . . .

3. ($\{\text{upper}\} - \{\text{lower}\}$)

All values in the range are sent/received in descending order.

This is a FIXED format. The number of data items must match the range specification.

Example: (2-0) (123-5) (1023-999) . . .

4. ($\{\text{lower}\} /$)

All values starting from lower and up to the array limit are sent/received in ascending order. This is a VARIABLE format. The number of data items does not have to match the range specification. When the K105-D is receiving data, the transmitter can send any amount of array-elements desired, up to the array limit.

Example: (2 /) (123 /) (1023 /) . . .

5. ($\{\text{upper}\} \backslash$)

All values starting from upper and down to array index zero are sent/received in descending order. This is a VARIABLE format. The number of data items does not have to match the range specification. When the K105-D is receiving data, the transmitter can send any amount of array-elements desired, down to array index zero.

Example: (2 \) (123 \) (1023 \) . . .

6. (-)

All values in the array are sent/received in ascending order.

This is a VARIABLE Format: The number of data items does not have to match the range specification. When the K105-D is receiving data, the transmitter can send any amount of array-elements desired, up to the array limit.

7. ($\{\text{lower}\}$: $\{\text{upper}\}$)

This range specification is valid only for setup (K105-D receiving) records.

Only one array value is received, and all array elements in the range are set to that value.

Example: (0:2) (5:123) (999:1023) . . .

8. ($\{\text{upper}\}$: $\{\text{lower}\}$)

This range specification is valid only for setup (K105-D receiving) records.

Only one array value is received, and all array elements in the range are set to that value.

Example: (2:0) (123:5) (1023:999) . . .

9. (:)

This range specification is valid only for setup (K105-D receiving) records.

Only one array value is received, and all array elements from index zero up to the array limit are set to that value.

NOTE: When the communication port is GPIB, the FIXED format range specifications (1,2,3) are processed slightly faster than the VARIABLE format range specifications.

INDEX BY COMMAND

	see page
C-	Send All Clock Setup Records 5-15
CC	Clock Setup. 5-14
CD	Clock Demux. 5-11
CS	Clock Sections 5-13
CX	Clock Expressions. 5-12
DC	Clear Display. 5-94
DS	Display Screen 5-96
DT	Display Text on CRT. 5-97
F-	Send all Format Setup Records. 5-22
FD	Format Data. 5-16
FF	Format Format. 5-17
FL	Format Level 5-18
FP	Format Polarity. 5-19
FT	Format Threshold 5-20
FV	Format Var Voltage 5-21
H-	Send All High Speed Data Records 5-86
HA/HB/HX	High Speed Data. 5-79
HC	High Speed Control Position. 5-78
HG	High Speed Graph Expansion 5-80
HL	High Speed Timing Label. 5-82
HQ	High Speed Timing Sequence 5-84
HR	High Speed Reference Position. 5-83
HS	High Speed Search Value. 5-85
HT	High Speed Timing Expansion. 5-81

INDEX BY COMMAND (cont'd)

	page
KC	K105-D Configuration 5-98
KK	Device Clear 5-95
KT	K105-D Status. 5-99
LA/LB	Main Channel Level Data. 5-70
M-	Send all Main Channel Data Records 5-77
MA/MB/MX	Main Channel Data. 5-68
MC	Main Channel Control Position. 5-67
MG	Main Channel Graph Expansion 5-69
MH	Main/High Speed Select 5-102
ML	Main Channel Timing Labels 5-75
MQ	Main Channel Timing Sequence 5-76
MR	Main Channel Reference Position. 5-71
MS	Main Channel Search Value. 5-73
MT	Main Channel Timing Expansion 5-74
MV	Main Channel Search Level. 5-72
N-	Send All Noise Margin Analysis Setup Records 5-55
NB	Noise Margin Analysis, Main Beginning Threshold. 5-52
NC	Noise Margin Analysis, High Speed Beginning Threshold. 5-50
ND	Noise Margin Analysis, High Speed Ending Threshold 5-51
NE	Noise Margin Analysis, Main Ending Threshold 5-53
NS	Noise Margin Analysis, Main Select 5-54
PD	Print Screen Direct. 5-103
PG	Print Graphic 5-105
PL	Print Screen Long. 5-104

INDEX BY COMMAND (cont'd)

	see page
QQ	Acquisition Control 5-93
R-	Send All Arm Mode Setup Records 5-36
RA	Arm Mode Auto Flush 5-32
RC	Arm Mode Condition Function 5-33
RI	Arm Mode Input Field 5-31
RM	Arm Mode Mode Field 5-34
RP	Arm Mode Pass Counter 5-35
S-	Send All High Speed Setup Records 5-66
SC	High Speed Clock Setup 5-56
SD	High Speed Delay 5-57
SF	High Speed Filter 5-58
SG	High Speed Trigger Polarity 5-65
SI	High Speed Input Mode 5-59
SL	High Speed Link 5-60
SP	High Speed Polarity 5-61
SS	High Speed Sequence 5-62
ST	High Speed Threshold 5-63
SX	High Speed Trigger 5-64
T-	Send All Trace Control Setup Records 5-30
TC	Trace Control Command 5-23
TN	Trace Control Pattern Name 5-28
TP	Trace Control Parameter Field 5-27
TR	Transfer Setup Memories between M, A, or B 5-106
TV	Trace Control Pattern Value Field 5-29

INDEX BY COMMAND (cont'd)

	see page
U-	Send All Auto Compare Setup Records. 5-49
UA	Auto Compare, Main Start A 5-47
UB	Auto Compare, Main Start B 5-48
UE	Auto Compare, Main Edge Tolerance. 5-44
UL	Auto Compare, Main Length. 5-45
US	Auto Compare, Main Select. 5-46
UZ	Auto Compare, Main Channel Select. 5-43
WA	Auto Compare, High Speed Start A 5-41
WB	Auto Compare, High Speed Start B 5-42
WE	Auto Compare, High Speed Edge Tolerance. 5-38
WL	Auto Compare, High Speed Length. 5-39
WS	Auto Compare, High Speed Select. 5-40
WZ	Auto Compare, High speed Channel Select. 5-37
XL	Histogram Level Selection. 5-107
Z-	Send All Search Data Records 5-92
ZC	Search/Compare Control 5-87
ZF	Search First 5-88
ZL	Search Last. 5-89
ZR	Search Results Array 5-90
ZT	Search Total 5-91
--	Send All Setup Records 5-108
\$+, \$-	Keystroke Records. 5-101

THIS PAGE INTENTIONALLY BLANK

SYNTAX

<u>MEMORY INDICATOR</u>	<u>RECORD ID</u>	<u>RANGE SPECIFICATION</u>	<u>DATA</u>
[A B]	{CD}	{(INDEX)}	{=} { [S] [D] } {EOL}

Record Type - Request and Setup

The selected index must be in the range of 0 through 1. This index specifies section D or B, respectively. Sending S selects Sample; sending D selects Demux.

Example: **CD<0>=D**

CLOCK EXPRESSIONS (CX)

SYNTAX

<u>MEMORY INDICATOR</u>	<u>RECORD ID</u>	<u>RANGE SPECIFICATION</u>	<u>DATA</u>
$\left[\begin{array}{c} A \\ B \end{array} \right]$	$\{ CX \}$	$\{ (INDEX) \}$	$\{ = \} \{ \text{ASCII name} \} \left\{ \begin{array}{c} [H] \\ [L] \\ [*] \end{array} \right\}^8 \{ EOL \}$

Record Type - Request and Setup

The selected index must be in the range of 0 through 3. This index specifies the Clock Combination Definition Inputs.

The selected ASCII name must consist of 8 ASCII characters, (spaces can be used) and specifies the clock inputs.

Sending * selects not used; sending H selects Active High; sending L selects Active Low. This entry must be repeated eight times (once for each clock input, beginning with the leftmost input).

Example: `CX(1)=AAAAAAAA*****`

SYNTAX

<u>MEMORY INDICATOR</u>	<u>RECORD ID</u>	<u>RANGE SPECIFICATION</u>	<u>DATA</u>
[A B]	{CS}	{(INDEX)}	{=} {INTEGER} {EOL}

Record Type - Request and Setup

The selected index must be in the range of 0 through 4. This index selects the clock sections, which are ordered from top to bottom as follows:

- 0 - Master clock
- 1 - Section D
- 2 - Section C
- 3 - Section B
- 4 - Section A

The selected integer must be one digit in the range of 0 through 7. This integer corresponds to the quick key code for the Master Clock Source field, as follows:

- (0) Clock source 0, not inverted
- (1) Clock source 0, inverted
- (2) Clock source 1, not inverted
- (3) Clock source 1, inverted
- (4) Clock source 2, not inverted
- (5) Clock source 2, inverted
- (6) Clock source 3, not inverted
- (7) Clock source 3, inverted

Example: CS(0)=1

CLOCK SETUP (CC)

SYNTAX

<u>MEMORY INDICATOR</u>	<u>RECORD ID</u>	<u>RANGE SPECIFICATION</u>	<u>DATA</u>
[A] [B]	{CC}	NA	{=} { [E] [M] } { [I] [INTEGER] [ALPHA CHAR] } {EOL}

Request Type - Request and Setup

where: E = External, M = External Multiphase, and I = Internal.

When I is selected, the selected integer must be in the range of 0 through 8.

This integer corresponds to the quick key code for Clock Interval, as follows:

0 - 1
1 - 2
2 - 5
3 - 10
4 - 20
5 - 50
6 - 100
7 - 200
8 - 500

The selected alpha character for I must be either N, U, or M, which specifies the time in either nanoseconds, microseconds, or milliseconds, respectively.

Example: CC=I8U

SEND ALL CLOCK SETUP RECORDS (C-)

SYNTAX

<u>MEMORY INDICATOR</u>	<u>RECORD ID</u>	<u>RANGE SPECIFICATION</u>	<u>DATA</u>	
[A B]	{ C- }	NA	NA	{ EOL }

Record Type - Request Only

The K105-D responds by sending the following setup records:

CC, CS, CX, CD

Example: C-

FORMAT DATA (FD)

SYNTAX

MEMORY INDICATOR	RECORD ID	RANGE SPECIFICATION	DATA
[A B]	{ FD }	{ (INDEX) }	{ = } { DIGIT } { Alpha Char } { Hex Char } { EOL }

Record Type - Request and Setup

The selected index must be in a range of 0 through 39. This index specifies the column number.

The selected integer, which represents the radix, must be in the range of 0 through 7. This integer specifies the number of Alpha and Hex character entry pairs to be entered as follows:

0				Blank Column
1	Section input			Binary Column
2	Section input MSB	Section input LSB		Quad Column
3				Octal Column
4	Section input MSB	Section input	Section input LSB	Hex Column
5				'X'
6				ASCII 6
7				ASCII 7

The selected alpha character must be in the range of A through D; the selected Hex character must be in the range of 0 through F. These Alpha and Hex characters specify the section input and input number, respectively. The alpha character of each entry pair must remain the same for a given column.

Example: **FD(35)=4A1A2A3A4**

SYNTAX

<u>MEMORY INDICATOR</u>	<u>RECORD ID</u>	<u>RANGE SPECIFICATION</u>	<u>DATA</u>
[A B]	{FF}	NA	{=} {INTEGER} {EOL}

Record Type - Request and Setup

The selected integer must be one digit in the range of 0 through 6. This integer is equivalent to the quick key choices for Data Format Field on the K105-D, as follows:

- (0) Hex - fixed format
- (1) Octal - fixed format
- (2) Binary - fixed format, sections D through A, inputs 7 through 0
- (3) Binary - fixed format, sections D and C, inputs F through 0
(not present on 32 input units)
- (4) Binary - fixed format, sections A and B, inputs F through 0
(not present on 32 input units)
- (5) User specified
- (6) Disassembler

Example: FF=0

FORMAT LEVEL (FL)

SYNTAX

<u>MEMORY INDICATOR</u>	<u>RECORD ID</u>	<u>RANGE SPECIFICATION</u>	<u>DATA</u>
$\begin{bmatrix} A \\ B \end{bmatrix}$	$\{ FL \}$	NA	$\{ = \} \begin{Bmatrix} [T] \\ [F] \end{Bmatrix} \{ EOL \}$

Record Type - Request and Setup

Sending T specifies the level number field is present on the Data Display screen; sending F specifies the level number field is not present on the Data Display Screen.

Example: **FL=T**

FORMAT POLARITY (FP)

SYNTAX

<u>MEMORY INDICATOR</u>	<u>RECORD ID</u>	<u>RANGE SPECIFICATION</u>	<u>DATA</u>
$\begin{bmatrix} A \\ B \end{bmatrix}$	$\{FP\}$	$\{(INDEX)\}$	$\{=\} \begin{bmatrix} \{I+\} \\ \{I-\} \end{bmatrix} \{EOL\}$

Record Type - Request and Setup

The selected index must be in a range of 0 through 63. This index specifies the polarity field, with 0 corresponding to input A0 and 63 corresponding to input DF.

Example: $FP\langle 60 \rangle = +$

FORMAT THRESHOLD (FT)

SYNTAX

<u>MEMORY INDICATOR</u>	<u>RECORD ID</u>	<u>RANGE SPECIFICATION</u>	<u>DATA</u>
$\left[\begin{array}{c} A \\ B \end{array} \right]$	$\{ FT \}$	$\{ (INDEX) \}$	$\{ = \} \left\{ \begin{array}{c} [T] \\ [E] \\ [V] \end{array} \right\} \{ EOL \}$

Record Type - Request and Setup

The selected index must be in the range of 0 through 8. This index specifies the data input group, as follows:

DATA INPUT GROUP	INTEGER
DF - D8	7
D7 - D0	6
CF - C8	5
C7 - C0	4
BF - B8	3
B7 - B0	2
AF - A8	1
A7 - A0	0
Clock Inputs	8

The selected alpha character specifies the voltage setting of the data input; sending either T, E, or V selects TTL, ECL, or VAR, respectively.

Example: **FT(0)=T**

FORMAT VAR VOLTAGE (FV)

SYNTAX

MEMORY INDICATOR	RECORD ID	RANGE SPECIFICATION	DATA
<div style="border: 1px solid black; padding: 2px; display: inline-block;"> A B </div>	{ FV }	NA	{ = } { [+] [-] } { INTEGER } { INTEGER } { EOL }

Record Type - Request and Setup

The entry immediately to the right of the equal sign specifies the polarity of the variable voltage.

Both selected integers for VAR voltage must be in the range of 0 through 9.

Example: **FV=+12**

SEND ALL FORMAT SETUP RECORDS (F-)

SYNTAX

<u>MEMORY INDICATOR</u>	<u>RECORD ID</u>	<u>RANGE SPECIFICATION</u>	<u>DATA</u>	
[A B]	{ F- }	NA	NA	{ EOL }

Record Type - Request Only

The K105-D responds by sending the following setup records:

FD, FT, FV, FP, FF, FL

TRACE CONTROL COMMAND (TC)

SYNTAX

MEMORY INDICATOR	RECORD ID	RANGE SPECIFICATION	DATA
<div style="border: 1px solid black; padding: 2px; display: inline-block;"> A B </div>	{ TC }	{ (INDEX) }	{ = } { ASCII STRING } { EOL }

Record Type - Request and Setup

The selected index must be in the range of 0 through 49. This index specifies the line number of the trace control.

The ASCII string must consist of eighteen ASCII characters selected as follows in the table 5-1. Definitions for entries are provided following the table.

Table 5-1. Trace Control Command Entries

ASCII CHAR. ENTRY	FUNCTION	COMMAND SELECTION	ENTRY SELECTIONS
1	COMMAND		* W T U G S A D E L J H
2	COMMAND EXTENSION	If command = W or T If command = G or J If command = L otherwise	* F U I (0...7) (0...4) *
3	CONDITION SELECT	If command is W,T,U,G,S,A otherwise	S C A *
4	PATTERN MATCH	If command is W,T,U,G,S,A otherwise	E N *
5,6	PATTERN SELECT	Must be number of valid pattern	(00...49)

TRACE CONTROL COMMAND (TC) (Cont'd)

Table 5-1. Trace Control Command Entries (Cont'd)

ASCII CHAR. ENTRY #	FUNCTION	COMMAND SELECTION	ENTRY SELECTIONS
7,8,9 10,11	PATTERN FILL-IN DIGIT	If selected pattern has no fill-in columns If selected pattern has one fill-in column	all *'s **** (0...F)
12	DELAY RELATION	If character 2 is C or A otherwise	>= G # L < *
13 - 17	PARAMETER FILL-IN DATA	If command = L otherwise	(00001...04095) (00001...65535)
18	DELAY BY	If command is WF TF or D otherwise	(C or S) *

ENTRY DEFINITIONS:

ASCII CHARACTER
ENTRY #

1st	<u>ENTRY</u>	<u>DEFINITION</u>
	*	Null
	W	Wait
	T	Trace
	U	or Until
	G	or GO TO
	S	or STOP
	A	Advance
	D	Set Delay
	E	Stop when level E entered
	L	Link
	J	GO TO
	H	STOP

TRACE CONTROL COMMAND (TC) (Cont'd)

ENTRY DEFINITIONS: (Cont'd)

ASCII CHARACTER

ENTRY

2nd	<u>ENTRY</u> * F U I (0...7) (0...4) *	<u>DEFINITION</u> Don't Care - Blank FOR Until If Target Level Link Condition
3rd	<u>ENTRY</u> S C A *	<u>DEFINITION</u> Sample Pattern Count Sample and Count don't care
4th	<u>ENTRY</u> E N *	<u>DEFINITION</u> When equal When not equal don't care
5th and 6th	<u>ENTRY</u> 00..49	<u>DEFINITION</u> Pattern Number
7th through 11th	<u>ENTRY</u> (0..F) *	<u>DEFINITION</u> Hexadecimal Data Don't Care
12th	> = < G # L *	Count greater than delay Count equal to delay Count less than delay Count greater than or equal to delay Count not equal to delay Count less than or equal to delay

TRACE CONTROL COMMAND (TC)(Cont'd)

ENTRY DEFINITIONS: (Cont'd)

ASCII CHARACTER
ENTRY #

13th through 17th	<u>ENTRY</u>	<u>DEFINITION</u>
	(00001...04095)	level entry count
	(00001...65535)	delay count
18th	<u>ENTRY</u>	<u>DEFINITION</u>
	C	Clocks
	S	Delay Counts of Sample

Example: **TC(0)=WFSE00*****00001C**

TRACE CONTROL PARAMETER FIELD (TP)

SYNTAX

<u>MEMORY INDICATOR</u>	<u>RECORD ID</u>	<u>RANGE SPECIFICATION</u>	<u>DATA</u>
<div style="border: 1px solid black; padding: 2px; display: inline-block;"> A B </div>	{ TP }	{ (INDEX) }	{ = } { INTEGER } { DECIMAL DECIMAL } { EOL }

Record Type - Request and Setup

The selected index must be in the range of 0 through 49. This index represents the pattern line number.

The selected integer must be in the range of 0 through 5 and specifies the number of entries. Selecting 0 clears any set parameters.

The decimal pair entered must be in a range of 00 through 39. The number of pairs must coincide with the specified integer number. The selected decimals are the column fill-ins.

Example: **TP(35)=400112233**

TRACE CONTROL PATTERN NAME (TN)

SYNTAX

<u>MEMORY INDICATOR</u>	<u>RECORD ID</u>	<u>RANGE SPECIFICATION</u>	<u>DATA</u>
$\left[\begin{array}{c} A \\ B \end{array} \right]$	$\{ TN \}$	$\{ (INDEX) \}$	$\{ = \} \{ \text{EIGHT ASCII CHAR} \} \{ \text{EOL} \}$

Record Type - Request and Setup

The selected index must be in the range of 0 through 49. This index specifies the sequentially numbered Pattern Definition Lines, beginning with 0 from top to bottom.

The selected eight ASCII characters specify the pattern name and may be any combination of ASCII alpha characters, numeric symbols and spaces.

Example: `TN(5)=INCREASE`

TRACE CONTROL PATTERN VALUE FIELD (TV)

SYNTAX

MEMORY INDICATOR	RECORD ID	RANGE SPECIFICATION	DATA	
<div style="border: 1px solid black; padding: 2px; display: inline-block;">A B</div>	<div style="font-size: 2em;">{</div> TV <div style="font-size: 2em;">}</div>	<div style="font-size: 2em;">{</div> (INDEX) <div style="font-size: 2em;">}</div>	<div style="font-size: 2em;">{</div> = <div style="font-size: 2em;">}</div> <div style="display: inline-block; vertical-align: middle; margin-left: 10px;"> <div style="font-size: 2em;">{</div>[*]<div style="font-size: 2em;">}</div> <div style="font-size: 2em;">{</div>[1]<div style="font-size: 2em;">}</div> <div style="font-size: 2em;">{</div>[0]<div style="font-size: 2em;">}</div> </div> <div style="font-size: 2em; vertical-align: middle;">}</div> 64	<div style="font-size: 2em;">{</div> EOL <div style="font-size: 2em;">}</div>

Record Type - Request and Setup

The selected index must be in the range of 0 through 49. This index specifies the pattern definition line number, ordered from top to bottom, beginning with 0.

A combination of asterisk, 0, or 1 must be sent sixty-four times, selecting Don't Care, 0 or 1, (respectively) for each of the 64 main inputs. The first character sent corresponds to input DF and the last character sent corresponds to input AD.

Example: TV(0)=00000 ←—————→ 00000

SEND ALL TRACE CONTROL SETUP RECORDS (T-)

SYNTAX

<u>MEMORY INDICATOR</u>	<u>RECORD ID</u>	<u>RANGE SPECIFICATION</u>	<u>DATA</u>
[A B]	{ T- }	NA	NA { EOL }

Record Type - Request Only

The K105-D responds by sending the following setup records:

TC, TN, TP, TV

ARM MODE INPUT FIELD (RI)

SYNTAX

<u>MEMORY INDICATOR</u>	<u>RECORD ID</u>	<u>RANGE SPECIFICATION</u>	<u>DATA</u>
$\begin{bmatrix} A \\ B \end{bmatrix}$	$\{RI\}$	NA	$\{=\} \begin{Bmatrix} [M] \\ [B] \\ [H] \end{Bmatrix} \{EOL\}$

Record Type - Request and Setup

Sending M selects Main inputs; sending H selects High Speed inputs; sending B selects Main and High Speed inputs.

Example: RI=M

ARM MODE AUTO FLUSH (RA)

SYNTAX

<u>MEMORY INDICATOR</u>	<u>RECORD ID</u>	<u>RANGE SPECIFICATION</u>	<u>DATA</u>
$\begin{bmatrix} A \\ B \end{bmatrix}$	$\{RA\}$	NA	$\{=\}\{\begin{bmatrix} T \\ F \end{bmatrix}\}\{EOL\}$

Record Type - Request and Setup

Sending T for true specifies Auto Flush; sending F for false specifies no Auto Flush.

Example: RA=T

ARM MODE CONDITION FUNCTION (RC)

SYNTAX

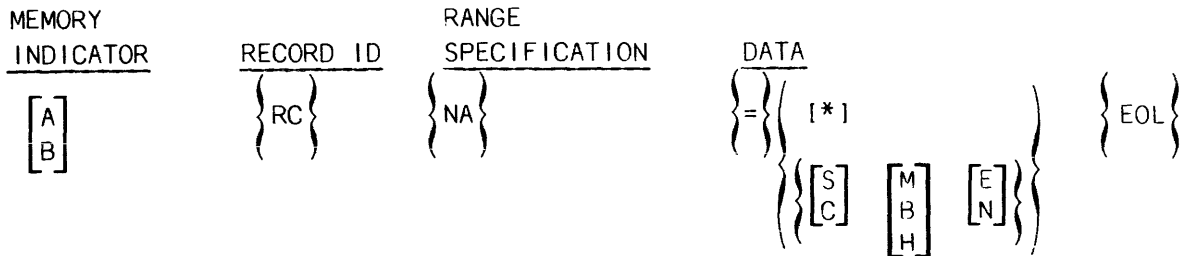

Record Type - Request and Setup

If * is sent, it selects no auto compare; if S is sent, it selects stop on auto compare condition; if C is sent, it selects count on auto compare condition. S or C must be followed by sending either M, B, or H, which selects compare Main Inputs, compare both Main and High Speed Inputs or compare High Speed only, respectively. M, B, or H must be followed by sending either E, which selects condition true if memory A equals memory B, or sending N, which selects condition true, if memory A does not equal memory B.

Example: RC=SME

ARM MODE MODE FIELD (RM)

SYNTAX

<u>MEMORY INDICATOR</u>	<u>RECORD ID</u>	<u>RANGE SPECIFICATION</u>	<u>DATA</u>
$\begin{bmatrix} A \\ B \end{bmatrix}$	$\{RM\}$	NA	$\{=\} \begin{bmatrix} [M] \\ [A] \end{bmatrix} \{EOL\}$

Record Type - Request and Setup

Sending M selects Manual Arm Mode; sending A selects Auto Arm Mode.

Example: RM=M

ARM MODE PASS COUNTER (RP)

SYNTAX

<u>MEMORY INDICATOR</u>	<u>RECORD ID</u>	<u>RANGE SPECIFICATION</u>	<u>DATA</u>
$\begin{bmatrix} A \\ B \end{bmatrix}$	$\{RP\}$	NA	$\{=\} \left\{ \begin{array}{l} [*] \\ [INTEGER] \end{array} \right\} \{EOL\}$

Record Type - Request and Setup

When * is sent, it specifies no pass counter limit. The selected integer must be four digits in the range of 0001 through 9999 and specifies the pass count limit.

If memory A is selected, the instrument returns the current value of the pass counter.

Example: RP=0001

SEND ALL ARM MODE SETUP RECORDS (R-)

SYNTAX

<u>MEMORY INDICATOR</u>	<u>RECORD ID</u>	<u>RANGE SPECIFICATION</u>	<u>DATA</u>
$\begin{bmatrix} A \\ B \end{bmatrix}$	$\{ R- \}$	NA	NA $\{ EOL \}$

Record Type - Request Only

The K105-D responds by sending the following setup records:

RA, RM, RI, RP, RC

AUTO COMPARE, HIGH SPEED CHANNEL SELECT (WZ)

SYNTAX

MEMORY INDICATOR	RECORD ID	RANGE SPECIFICATION	DATA
<div style="border: 1px solid black; padding: 2px; display: inline-block;"> A B </div>	{WZ}	NA	{=} {101} 16 {111} {EOL}

Record Type - Request and Setup

Sending 1 or 0 sixteen times specifies which high speed inputs are to be compared or ignored, respectively. The entries 1 and 0 appear as a checkmark or underscore, respectively, on the input display.

Entry Column	Corresponding High Speed Input
0	F
1	E
2	D
3	C
4	B
5	A
6	9
7	8
8	7
9	6
10	5
11	4
12	3
13	2
14	1
15	0

The leftmost entry corresponds to high speed input F; the rightmost entry corresponds to high speed input 0.

Example: WZ=0000000000000000

AUTO COMPARE, HIGH SPEED EDGE TOLERANCE (WE)

SYNTAX

<u>MEMORY INDICATOR</u>	<u>RECORD ID</u>	<u>RANGE SPECIFICATION</u>	<u>DATA</u>	
NA	{ WE }	NA	{ = } { INTEGER }	{ EOL }

Record Type - Request and Setup

The selected integer must be one digit in a range of 0 through 9. This integer specifies the High Speed Edge Tolerance for memory B. Once the tolerance is entered, the specified number of samples before and after each edge transition will be set to don't care on each A to B data transfer.

Example: WE=8

AUTO COMPARE, HIGH SPEED LENGTH (WL)

SYNTAX

<u>MEMORY INDICATOR</u>	<u>RECORD ID</u>	<u>RANGE SPECIFICATION</u>	<u>DATA</u>	
[A B]	{WL}	NA	{=} {INTEGER}	{EOL}

Record Type - Request and Setup

The selected integer must be four digits in the range of 0001 through 1024. This integer selects the number of data samples to be compared. The maximum number of samples to be compared on each arm cycle is dependent on the sample number selected for the beginning of the comparison.

Example: WL=1000

AUTO COMPARE, HIGH SPEED SELECT (WS)

SYNTAX

<u>MEMORY INDICATOR</u>	<u>RECORD ID</u>	<u>RANGE SPECIFICATION</u>	<u>DATA</u>
$\begin{bmatrix} A \\ B \end{bmatrix}$	$\{ WS \}$	NA	$\{ = \} \begin{Bmatrix} [F] \\ [A] \\ [S] \\ [X] \end{Bmatrix} \{ EOL \}$

Record Type - Request and Setup

Entering either F, A, S or X selects the setup auto compare field as follows:

- F - High Speed inputs selected on format screen
- A - All High Speed inputs
- S - Selected High Speed inputs
- X - Selected High Speed inputs - Memory A

Example: **WS=F**

AUTO COMPARE, HIGH SPEED START A (WA)

SYNTAX

<u>MEMORY INDICATOR</u>	<u>RECORD ID</u>	<u>RANGE SPECIFICATION</u>	<u>DATA</u>
$\begin{bmatrix} A \\ B \end{bmatrix}$	$\{WA\}$	NA	$\{=\} \{INTEGER\} \{EOL\}$

Record Type - Request and Setup

The selected integer must be four digits in the range of 0000 through 1023. This integer selects the starting sample in memory A for comparison. If the starting sample in memory B is not being explicitly selected, this record will also select the starting sample for the comparison in memory B.

Example: **WA=0001**

AUTO COMPARE, HIGH SPEED START B (WB)

SYNTAX

<u>MEMORY INDICATOR</u>	<u>RECORD ID</u>	<u>RANGE SPECIFICATION</u>	<u>DATA</u>	
$\begin{bmatrix} A \\ B \end{bmatrix}$	$\{WB\}$	NA	$\{=\} \{INTEGER\}$	$\{EOL\}$

Record Type - Request and Setup

The selected integer must be four digits in the range of 0000 through 1023. This integer selects the starting sample in memory B for comparison. This number is only used if the field, selected H.S. inputs -- mem A, is on the selected screen.

Example: **WB=0001**

AUTO COMPARE, MAIN CHANNEL SELECT (UZ)

SYNTAX

MEMORY INDICATOR	RECORD ID	RANGE SPECIFICATION	DATA
$\left[\begin{array}{c} A \\ B \end{array} \right]$	$\{UZ\}$	NA	$\{=\} \left\{ \begin{array}{c} 101 \\ 111 \end{array} \right\} 64 \quad \{EOL\}$

Record Type - Request and Setup

Sending either 0 or 1 sixty-four times specifies ignoring or selecting, respectively, inputs in the A to B comparison. The four section's inputs are ordered, from left to right, D, C, B and A. Within each section, inputs are mapped F through 0.

Example: UZ=0000 00000

AUTO COMPARE, MAIN EDGE TOLERANCE (UE)

SYNTAX

<u>MEMORY INDICATOR</u>	<u>RECORD ID</u>	<u>RANGE SPECIFICATION</u>	<u>DATA</u>	
NA	{UE}	NA	{=} {INTEGER}	{EOL}

Record Type - Request and Setup

The selected integer must be one digit in the range of 0 through 9. This integer selects the Auto Edge Tolerance for memory B. Once the tolerance is entered, the specified number of samples before and after each edge transition will be set to don't care on each A to B data transfer.

Example: UE=8

AUTO COMPARE, MAIN LENGTH (UL)

SYNTAX

<u>MEMORY INDICATOR</u>	<u>RECORD ID</u>	<u>RANGE SPECIFICATION</u>	<u>DATA</u>	
$\begin{bmatrix} A \\ B \end{bmatrix}$	$\{UL\}$	NA	$\{=\}$ $\{INTEGER\}$	$\{EOL\}$

Record Type - Request and Setup

The selected integer must be four digits in the range of 0001 through 1024. This integer selects the number of data samples to be compared. The maximum number of samples to be compared on each arm cycle is dependent on the sample number selected for the beginning of the comparison.

Example: **UL=0001**

AUTO COMPARE, MAIN SELECT (US)

SYNTAX

<u>MEMORY INDICATOR</u>	<u>RECORD ID</u>	<u>RANGE SPECIFICATION</u>	<u>DATA</u>
$\begin{bmatrix} A \\ B \end{bmatrix}$	$\{US\}$	NA	$\{=\} \begin{Bmatrix} [F] \\ [A] \\ [S] \\ [X] \end{Bmatrix} \quad \{EOL\}$

Record Type - Request and Setup

Entering either F, A, S or X selects the set up Auto Compare field as follows:

- F - Main inputs selected on the format screen
- A - All main inputs
- S - Selected main inputs
- X - Selected main inputs - memory A

Example: US=A

AUTO COMPARE, MAIN START A (UA)

SYNTAX

<u>MEMORY INDICATOR</u>	<u>RECORD ID</u>	<u>RANGE SPECIFICATION</u>	<u>DATA</u>	
$\left[\begin{array}{c} A \\ B \end{array} \right]$	$\{ UA \}$	NA	$\{ = \} \{ \text{INTEGER} \}$	$\{ \text{EOL} \}$

Record Type - Request and Setup

The selected integer must be four digits in the range of 0000 through 1023. This integer specifies the starting sample in memory A for comparison. If the starting sample in Memory B is not explicitly selected, this record will also select the starting sample for the comparison in memory B.

Example: UA=0000

AUTO COMPARE, MAIN START B (UB)

SYNTAX

<u>MEMORY INDICATOR</u>	<u>RECORD ID</u>	<u>RANGE SPECIFICATION</u>	<u>DATA</u>	
[A B]	{ UB }	NA	{ = } { INTEGER }	{ EOL }

Record Type - Request and Setup

The selected integer must be four digits in a range of 0000 through 1023. This integer selects the starting sample in memory B for comparison. This number is only used if the field, selected main inputs -- mem A, is on the selected screen.

Example: UB=1023

SEND ALL AUTO COMPARE SETUP RECORDS (U-)

SYNTAX

<u>MEMORY INDICATOR</u>	<u>RECORD ID</u>	<u>RANGE SPECIFICATION</u>	<u>DATA</u>	
[A B]	{ U- }	NA	NA	{ EOL }

Record Type - Request Only

The K105-D responds by sending the following setup records:

US, UA, UB, UL, UZ, UE, WS, WA, WB, WL, WZ, WE

NOISE MARGIN ANALYSIS, HIGH SPEED BEGINNING THRESHOLD (NC)

SYNTAX

<u>MEMORY INDICATOR</u>	<u>RECORD ID</u>	<u>RANGE SPECIFICATION</u>	<u>DATA</u>
NA	{ NC }	NA	{ = } { { [+] } { [-] } } { INTEGER } { INTEGER } { EOL }

Record Type - Request and Setup

Selecting + or - indicates positive or negative voltage, respectively. The selected integers must be in the range of 0 through 9 and specify the integer part and decimal fraction, respectively, of the beginning threshold voltage.

Example: NC=+12

NOISE MARGIN ANALYSIS, HIGH SPEED ENDING THRESHOLD (ND)

SYNTAX

MEMORY INDICATOR	RECORD ID	RANGE SPECIFICATION	DATA
NA	{ND}	NA	{=} { [+] } { [-] } { INTEGER } { INTEGER } { EOL }

Record Type - Request and Setup

Selecting + or - specifies positive or negative voltage, respectively. The selected integers must be in a range of 0 through 9 and specify the integer part and decimal fraction, respectively, of the ending threshold voltage.

Example: ND=+01

NOISE MARGIN ANALYSIS, MAIN BEGINNING THRESHOLD (NB)

SYNTAX

<u>MEMORY INDICATOR</u>	<u>RECORD ID</u>	<u>RANGE SPECIFICATION</u>	<u>DATA</u>
NA	{NB}	NA	{=} { [+] [-] } { INTEGER } { INTEGER } { EOL }

Record Type - Request and Setup

Selecting + or - selects positive or negative, respectively, threshold voltage. The selected integers must be in the range of 0 through 9 and specify the integer part and decimal fraction, respectively, of the main beginning threshold voltage.

Example: NB=+14

NOISE MARGIN ANALYSIS, MAIN ENDING THRESHOLD (NE)

SYNTAX

MEMORY INDICATOR	RECORD ID	RANGE SPECIFICATION	DATA
NA	{ NE }	NA	{ = } { [+] } { [-] } { INTEGER } { INTEGER } { EOL }

Record Type - Request and Setup

Selecting + or - specifies positive or negative threshold voltage, respectively. The selected integers must be in the range of 0 through 9 and specify the integer part and decimal fraction, respectively, of the main ending threshold voltage.

Example: NE=-50

NOISE MARGIN ANALYSIS, MAIN SELECT (NS)

SYNTAX

<u>MEMORY INDICATOR</u>	<u>RECORD ID</u>	<u>RANGE SPECIFICATION</u>	<u>DATA</u>
NA	{NS}	NA	{=} {HEX CHAR} {EOL}

Record Type - Request and Setup

The selected Hex character must be in the range of 0 through E. This character specifies the input on which noise analysis is performed, as follows:

- (0) A(7-0)
- (1) B(7-0)
- (2) C(7-0)
- (3) D(7-0)
- (4) A(F-8)
- (5) B(F-8)
- (6) C(F-8)
- (7) D(F-8)
- (8) A(F-0)
- (9) B(F-0)
- (A) C(F-0)
- (B) D(F-0)
- (C) BF-A0
- (D) CF-B0
- (E) DF-C0

Example: NS=A

SEND ALL NOISE MARGIN ANALYSIS SETUP RECORDS (N-)

SYNTAX

<u>MEMORY INDICATOR</u>	<u>RECORD ID</u>	<u>RANGE SPECIFICATION</u>	<u>DATA</u>	
NA	{ N- }	NA	NA	{ EOL }

Record Type - Request Only

The K105-D responds by sending the following setup records:

NS, NB, NE, NC, ND

HIGH SPEED CLOCK SETUP (SC)

SYNTAX

<u>MEMORY INDICATOR</u>	<u>RECORD ID</u>	<u>RANGE SPECIFICATION</u>	<u>DATA</u>
[A B]	{SC}	NA	{=} { [I] } { INTEGER } { [N] [U] [M] } { EOL } { [E] } { [L] } ² { [H] } { [*] }

Record Type - Request and Setup

When selecting I, the selected integer must be one digit in the range of 0 through 8. These integers correspond to the quick key code for the clock interval field as follows:

- (0) - 1
- (1) - 2
- (2) - 5
- (3) - 10
- (4) - 20
- (5) - 50
- (6) - 100
- (7) - 200
- (8) - 500

Sending either N, U, or M selects nanoseconds, microseconds, or milliseconds, respectively, for the clock decade field.

The legal internal clocks are 10 nanoseconds through 50 milliseconds.

When selecting E, sending either L, H, or * for the HJ clock input, or L, H or * for the HK clock input specifies the following:

- H - non inverted input
- L - inverted input
- * - not used

Example: **SC=I0N**

HIGH SPEED DELAY (SD)

SYNTAX

<u>MEMORY INDICATOR</u>	<u>RECORD ID</u>	<u>RANGE SPECIFICATION</u>	<u>DATA</u>
$\begin{bmatrix} A \\ B \end{bmatrix}$	$\{SD\}$	NA	$\{=\} \{INTEGER\} \begin{bmatrix} \{C\} \\ \{E\} \end{bmatrix} \{EOL\}$

Record Type - Request and Setup

The selected integer must be five digits in the range of 00001 and 65535. This integer specifies the High Speed Delay.

Sending C selects the clock delay field; sending E selects Events delay.

Example: **SD=00001C**

HIGH SPEED FILTER (SF)

SYNTAX

<u>MEMORY INDICATOR</u>	<u>RECORD ID</u>	<u>RANGE SPECIFICATION</u>	<u>DATA</u>
[A B]	{ SF }	NA	{ = } { HEX CHAR } { EOL }

Record Type - Request and Setup

The selected Hex character must be in the range of 1 through E. Sending this Hex character selects the High Speed filter. The High Speed filter is displayed in decimal.

Example: **SF=1**

HIGH SPEED INPUT MODE (SI)

SYNTAX

<u>MEMORY INDICATOR</u>	<u>RECORD ID</u>	<u>RANGE SPECIFICATION</u>	<u>DATA</u>
$\begin{bmatrix} A \\ B \end{bmatrix}$	$\{SI\}$	NA	$\{ = \} \left\{ \begin{bmatrix} G \\ S \end{bmatrix} \right\} \{EOL\}$

Record Type - Request and Setup

Selecting either G or S specifies Glitch input mode or Sample input mode, respectively, for the High Speed inputs.

Example: **SI=G**

HIGH SPEED LINK (SL)

SYNTAX

<u>MEMORY INDICATOR</u>	<u>RECORD ID</u>	<u>RANGE SPECIFICATION</u>	<u>DATA</u>
$\begin{bmatrix} A \\ B \end{bmatrix}$	$\{SL\}$	NA	$\{ = \} \begin{bmatrix} T \\ F \end{bmatrix} \{EOL\}$

Record Type - Request and Setup

Selecting T (Linked) or F (Not Linked) selects the relationship of the high speed inputs to the main inputs.

Example: **SL=1**

HIGH SPEED POLARITY (SP)

SYNTAX

<u>MEMORY INDICATOR</u>	<u>RECORD ID</u>	<u>RANGE SPECIFICATION</u>	<u>DATA</u>
$\begin{bmatrix} A \\ B \end{bmatrix}$	$\{SP\}$	$\{(INDEX)\}$	$\{=\} \begin{Bmatrix} [+1] \\ [-1] \end{Bmatrix} \{EOL\}$

Record Type - Request and Setup

The selected index must be in the range of 0 through 15. The index specifies the high speed inputs 0 through F, which begin with 0 on the lower right portion of the screen and progress from right to left and bottom to top.

Sending + (plus) selects the polarity field to be positive; sending - (minus) selects the polarity field to be negative.

Example: $SP(10)=-$

HIGH SPEED SEQUENCE (SS)

SYNTAX

<u>MEMORY INDICATOR</u>	<u>RECORD ID</u>	<u>RANGE SPECIFICATION</u>	<u>DATA</u>
$\begin{bmatrix} A \\ B \end{bmatrix}$	$\{SS\}$	$\{(INDEX)\}$	$\{=\} \left\{ \begin{array}{l} [*] \\ [HEX DIGIT] \end{array} \right\} \{EOL\}$

Record Type - Request and Setup

The selected index must be in the range of 0 through 30. This index specifies the columns, including spaces, of the sequence.

Sending an * places a space and deletes any character in the specified column. The Hex digit entry must be 0 through F.

The radix changes to reflect the character grouping.

Example: $SS(10)=0$

HIGH SPEED THRESHOLD (ST)

SYNTAX

<u>MEMORY INDICATOR</u>	<u>RECORD ID</u>	<u>RANGE SPECIFICATION</u>	<u>DATA</u>
$\begin{bmatrix} A \\ B \end{bmatrix}$	$\{ST\}$	$\{(INDEX)\}$	$\{=\} \begin{Bmatrix} [T] \\ [E] \\ [V] \end{Bmatrix} \{EOL\}$

Record Type - Request and Setup

The selected index must be in the range of 0 through 2. This index specifies the threshold groups which are ordered 0 for HS 7-0, 1 for HS F-8, and 2 for HJ, HK.

Sending T, E, or V specifies the threshold field to be TTL, ECL or VAR, respectively.

Example: $ST(0)=T$

HIGH SPEED TRIGGER (SX)

SYNTAX

<u>MEMORY INDICATOR</u>	<u>RECORD ID</u>	<u>RANGE SPECIFICATION</u>	<u>DATA</u>
$\begin{bmatrix} A \\ B \end{bmatrix}$	$\{SX\}$	NA	$\{=\} \left\{ \begin{bmatrix} [*] \\ [1] \\ [0] \end{bmatrix} \right\}^{16} \{EOL\}$

Record Type - Request and Setup

Send sixteen entries of *, 1 or 0 to change the trigger setup for the high speed inputs to either "don't-cares", 1's or 0's. The leftmost entry corresponds to high speed input F; the rightmost entry corresponds to high speed input 0.

Example: SX=1111111111111111

HIGH SPEED TRIGGER POLARITY (SG)

SYNTAX

<u>MEMORY INDICATOR</u>	<u>RECORD ID</u>	<u>RANGE SPECIFICATION</u>	<u>DATA</u>	
$\begin{bmatrix} A \\ B \end{bmatrix}$	$\{SG\}$	NA	$\{=\}$ $\begin{Bmatrix} [T] \\ [F] \end{Bmatrix}$	$\{EOL\}$

Record Type - Request and Setup

Selecting F or T specifies the trigger polarity to be true or false, respectively.

NOTE: This record type is included in both the Send All High Speed Setup Record (S-) and the Send All Setup Record Type (--).

Example: **SG=F**

SEND ALL HIGH SPEED SETUP RECORDS (S-)

SYNTAX

<u>MEMORY INDICATOR</u>	<u>RECORD ID</u>	<u>RANGE SPECIFICATION</u>	<u>DATA</u>	
[A B]	{S-}	NA	NA	{EOL}

Record Type - Request Only

The K105-D responds by sending the following setup records:

SS, SX, SD, SF, SC, ST, SP, SL, SI, SG

MAIN CHANNEL CONTROL POSITION (MC)

SYNTAX

<u>MEMORY INDICATOR</u>	<u>RECORD ID</u>	<u>RANGE SPECIFICATION</u>	<u>DATA</u>	
NA	{MC}	NA	{=} {INTEGER}	{EOL}

Record Type - Request and Setup

The selected integer must be in a range of 0000 through 1023 and specifies the control cursor location in the data display screens.

Example: **MC=1000**

MAIN CHANNEL DATA (MA/MB/MX)

SYNTAX

<u>MEMORY INDICATOR</u>	<u>RECORD ID</u>	<u>RANGE SPECIFICATION</u>	<u>DATA</u>
NA	{ MA MB MX }	{ (INDEX) }	{ = } { HEX } ¹⁶ { CHAR } { EOL }

Record Type - Request and Setup

MA selects Memory A, MB selects Memory B and MX selects Don't-Care Memory.

The selected index must be in the range of 0 through 1023 and specifies the memory location number.

The selected hex character must be in the range of 0 through F. Sending the hex character sixteen times specifies the value of the memory location.

Example: MB(1000)=0000000000000000

MAIN CHANNEL GRAPH EXPANSION (MG)

SYNTAX

MEMORY INDICATOR	RECORD ID	RANGE SPECIFICATION	DATA
NA	{MG}	NA	$\{=\}$ $\left\{ \begin{array}{l} [0] \\ [1] \\ [2] \\ [3] \end{array} \right\}$ $\left\{ \begin{array}{l} \text{HEX} \\ \text{CHAR} \end{array} \right\}^8$ $\left\{ \begin{array}{l} \text{HEX} \\ \text{CHAR} \end{array} \right\}^8$ $\{EOL\}$

Record Type - Request and Setup

The selected integer is either 0, 1, 2 or 3, which specifies X1, X6, X12 and X24, respectively, for the Horizontal Expansion.

The sixteen Hex characters selected must be in the range of 0 through F. The first and second groups of eight specify the upper and lower limit, respectively, of the main channel graph.

Example: MG=3 FFFFFFFF 00000000

MAIN CHANNEL LEVEL DATA (LA/LB)

SYNTAX

<u>MEMORY INDICATOR</u>	<u>RECORD ID</u>	<u>RANGE SPECIFICATION</u>	<u>DATA</u>	
NA	{ LA LB }	{ (INDEX) }	{ = } { INTEGER }	{ EOL }

Record Type - Request and Setup

The selected index must be in the range of 0 through 1023 and specifies the sample number.

The selected integer must be in the range of 0 through 7. This integer specifies the trace control level that was active when the sample was recorded.

Example: **LB(1000)=5**

MAIN CHANNEL REFERENCE POSITION (MR)

SYNTAX

<u>MEMORY INDICATOR</u>	<u>RECORD ID</u>	<u>RANGE SPECIFICATION</u>	<u>DATA</u>	
NA	{MR}	NA	{=} {INTEGER}	{EOL}

Record Type - Request and Setup

The selected integer must be in a range of 0000 through 1023 and specifies the location of the reference cursor in the data display screens.

Example: MR=1000

MAIN CHANNEL SEARCH LEVEL (MV)

SYNTAX

<u>MEMORY INDICATOR</u>	<u>RECORD ID</u>	<u>RANGE SPECIFICATION</u>	<u>DATA</u>
NA	{ MV }	NA	{ = } { [*] [INTEGER] } { EOL }

Record Type - Request and Setup

The selected integer must be in the range of 0 through 7. This integer or the selection of * (don't care) specifies the Search Level Value.

Example: MV=*

MAIN CHANNEL SEARCH VALUE (MS)

SYNTAX

<u>MEMORY INDICATOR</u>	<u>RECORD ID</u>	<u>RANGE SPECIFICATION</u>	<u>DATA</u>
NA	{MS}	{(INDEX)}	{=} { [*] [1] [0] } {EOL}

Record Type - Request and Setup

The selected index must be in the range of 0 through 63. This index specifies the main data input, with C corresponding to A0 and 63 corresponding to DF.

The value selection is either * (don't-care), 1 or 0.

Example: MS(50)=1

MAIN CHANNEL TIMING EXPANSION (MT)

SYNTAX

<u>MEMORY INDICATOR</u>	<u>RECORD ID</u>	<u>RANGE SPECIFICATION</u>	<u>DATA</u>
NA	{MT}	NA	{=} {INTEGER} {INTEGER} {INTEGER} {EOL}

Record Type - Request and Setup

The first selected integer must either be 0, 1, 2, or 3, which specifies X1, X6, X12 and X24, respectively, for the Horizontal Expansion. The second selected integer must be either 0, 1, or 2 which specifies V16, V8, or V4, respectively, for the Vertical Expansion.

The third selected integer must be in the range of 00 through 31. This integer selects the page number to be viewed and must always be entered as a two-digit numeral.

Example: **MT=0100**

MAIN CHANNEL TIMING LABELS (ML)

SYNTAX

<u>MEMORY INDICATOR</u>	<u>RECORD ID</u>	<u>RANGE SPECIFICATION</u>	<u>DATA</u>	
NA	{ML}	{(INDEX)}	{=} {ASCII CHAR} 5	{EOL}

Record Type - Request and Setup

The selected index must be in the range of 0 through 63. This index specifies the input line number, with 0 representing A0 input and 63 representing DF input.

Five ASCII characters must be selected; these characters represent the timing trace label.

Example: ML(50)=DATA6

MAIN CHANNEL TIMING SEQUENCE (MQ)

SYNTAX

<u>MEMORY INDICATOR</u>	<u>RECORD ID</u>	<u>RANGE SPECIFICATION</u>	<u>DATA</u>
NA	{MQ}	{(INDEX)}	{=} {ALPHA CHAR} {HEX CHAR}

Record Type - Request and Setup

The selected index must be in the range of 0 through 127. This index corresponds to the order of the traces, with 0 corresponding to the top trace on page 0 and 127 corresponding to the lowermost trace on the last page.

The selected Alpha and Hex characters specify the data input to be displayed on the desired locations. Entering ** instead of Alpha and Hex characters selects a blank field.

Example: MQ(100)=A5

SEND ALL MAIN CHANNEL DATA RECORDS (M-)

SYNTAX

<u>MEMORY INDICATOR</u>	<u>RECORD ID</u>	<u>RANGE SPECIFICATION</u>	<u>DATA</u>	
NA	{ M- }	NA	NA	{ EOL }

Record Type - Request Only

The K105-D responds by sending the following data records:

MA, MB, MX, LA, LB, MS, MV, ML, MT, MQ, MG, MC, MR

HIGH SPEED CONTROL POSITION (HC)

SYNTAX

<u>MEMORY INDICATOR</u>	<u>RECORD ID</u>	<u>RANGE SPECIFICATION</u>	<u>DATA</u>	
NA	{ HC }	NA	{ = } { INTEGER }	{ EOL }

Record Type - Request and Setup

The selected integer must be four digits in the range of 0000 through 1023. This integer specifies the location for the control cursor in the data display screens.

Example: HC=1000

HIGH SPEED DATA (HA/HB/HX)

SYNTAX

<u>MEMORY INDICATOR</u>	<u>RECORD ID</u>	<u>RANGE SPECIFICATION</u>	<u>DATA</u>
NA	{ HA HB HX }	{ (INDEX) }	{ = } { Hex Char } ⁴ { EOL }

Record Type - Request and Setup

Selecting HA specifies High Speed A; selecting HB specifies High Speed B; selecting HX specifies the don't care memory.

The selected index must be in a range of 0000 through 1023 and specifies the location number.

The selected Hex characters must be in a range of 0 through F. Sending four hex characters specifies the value at the memory location.

In the don't care memory, bits set to 0 correspond to "don't care"; bits set to 1 indicate "do care" for the corresponding data in Memory B.

Example: HA<1000>=0000

HIGH SPEED GRAPH EXPANSION (HG)

SYNTAX

<u>MEMORY INDICATOR</u>	<u>RECORD ID</u>	<u>RANGE SPECIFICATION</u>	<u>DATA</u>
NA	{HG}	NA	{ = } { INTEGER } { HEX CHAR } ⁸ { HEX CHAR } ⁸ { EOL }

Record Type - Request and Setup

The selected integer must be either 0, 1, 2 or 3; this integer specifies X1, X6, X12 and X24, respectively, for the Horizontal Expansion.

The selected first and second Hex characters must be in the range of 0 through F. Sending the first and second characters eight times each specifies the upper and lower limit, respectively, of the High Speed Graph.

Example: HG=01111111 00000000

HIGH SPEED TIMING EXPANSION (HT)

SYNTAX

<u>MEMORY INDICATOR</u>	<u>RECORD ID</u>	<u>RANGE SPECIFICATION</u>	<u>DATA</u>
NA	{ HT }	NA	{ = } { INTEGER } { INTEGER } { INTEGER } { EOL }

Record Type - Request and Setup

The first integer selected must be either 0, 1, 2, or 3. This integer specifies X1, X6, X12, and X24, respectively, for the Horizontal Expansion.

The second integer selected must be either 0, 1, or 2. This integer specifies V16, V8 and V4, respectively, for the Vertical Expansion.

The third integer selected must be in the range of 00 through 31. This integer selects the page number to be viewed and must always be entered as a double-digit numeral.

Example: HT=0100

HIGH SPEED TIMING LABEL (HL)

SYNTAX

<u>MEMORY INDICATOR</u>	<u>RECORD ID</u>	<u>RANGE SPECIFICATION</u>	<u>DATA</u>	
NA	{ HL }	{ (INDEX) }	{ = } { ASCII NAME }	{ EOL }

Record Type - Request and Setup

The selected index must be in the range of 0 through 15. This index specifies the input to be labeled.

The selected ASCII name can be any combination of five characters. Sending these characters places them in the specified row.

Example: HL<10>=DATA6

HIGH SPEED REFERENCE POSITION (HR)

SYNTAX

<u>MEMORY INDICATOR</u>	<u>RECORD ID</u>	<u>RANGE SPECIFICATION</u>	<u>DATA</u>	
NA	{ HR }	NA	{ = } { INTEGER }	{ EOL }

Record Type - Request and Setup

The selected integer must be in the range of 0000 and 1023. This integer specifies the location of the reference cursor on the data display screens.

Example: **HR=1023**

HIGH SPEED TIMING SEQUENCE (HQ)

SYNTAX

<u>MEMORY INDICATOR</u>	<u>RECORD ID</u>	<u>RANGE SPECIFICATION</u>	<u>DATA</u>
NA	{HQ}	{(INDEX)}	{=} {HEX CHAR}

Record Type - Request and Setup

The selected index must be in the range of 0 through 31. This index corresponds to the order of traces, with 0 corresponding to the top trace on page 0 and 31 corresponding to the lowermost trace on the last page.

The selected Hex character selects the High Speed input. Entering * instead of a Hex character selects a blank field.

Example: HQ(0)=5

HIGH SPEED SEARCH VALUE (HS)

SYNTAX

<u>MEMORY INDICATOR</u>	<u>RECORD ID</u>	<u>RANGE SPECIFICATION</u>	<u>DATA</u>
NA	{ HS }	{ (INDEX) }	{ = } { [*] } { [1] } { [0] } { EOL }

Record Type - Request and Setup

The selected index must be in a range of 0 through 15. This index specifies the high speed input.

Sending either *, 1, or 0 specifies the value on the search line.

Example: HS(5)=1

SEND ALL HIGH SPEED DATA RECORDS (H-)

SYNTAX

<u>MEMORY INDICATOR</u>	<u>RECORD ID</u>	<u>RANGE SPECIFICATION</u>	<u>DATA</u>	
NA	{ H- }	NA	NA	{ EOL }

Record Type - Request Only

The K105-D responds by sending the following data records:

HA, HB, HX, HS, HL, HT, HQ, HG, HC, HR

SEARCH/COMPARE (ZC)

SYNTAX

<u>MEMORY INDICATOR</u>	<u>RECORD ID</u>	<u>RANGE SPECIFICATION</u>	<u>DATA</u>
NA	{ ZC }	NA	{ = } { { 01 } { 11 } { 21 } } { EOL }

Record Type - Request and Setup

Sending 0, 1 or 2 selects nothing, search or compare modes, respectively, for the K105-D.

Example: ZC=0

SEARCH FIRST (ZF)

SYNTAX

<u>MEMORY INDICATOR</u>	<u>RECORD ID</u>	<u>RANGE SPECIFICATION</u>	<u>DATA</u>
NA	{ ZF }	NA	{ EOL }

Record Type - Request Only

The K105-D returns an integer in the range of 0000 through 1023; this integer specifies the first sample tagged in memory.

Example: **ZF=0009**

SEARCH LAST (ZL)

SYNTAX

<u>MEMORY INDICATOR</u>	<u>RECORD ID</u>	<u>RANGE SPECIFICATION</u>	<u>DATA</u>
NA	{ ZL }	NA	{ EOL }

Record Type - Request Only

The K105-D returns an integer in the range of 0000 through 1023; this integer specifies the last sample tagged in memory.

Example: **ZL=0777**

SEARCH RESULTS ARRAY (ZR)

SYNTAX

<u>MEMORY INDICATOR</u>	<u>RECORD ID</u>	<u>RANGE SPECIFICATION</u>	<u>DATA</u>
NA	{ZR}	{(INDEX)}	{=} { [0] } { [1] } {EOL}

Record Type - Request Only

The selected index must be in the range of 0 through 1023. This index specifies a sample number or a range of sample numbers.

A value of 0 indicates the sample number is not tagged; a value of 1 indicates the sample number is tagged.

When in search, the tag is an *; when in compare the tag is ≠.

Example: ZR(1000)=0

SEARCH TOTAL (ZT)

SYNTAX

<u>MEMORY INDICATOR</u>	<u>RECORD ID</u>	<u>RANGE SPECIFICATION</u>	<u>DATA</u>
NA	{ ZT }	NA	{ EOL }

Record Type - Request Only

The K105-D returns an integer in the range of 0000 through 1024; this integer specifies the number of samples tagged by search or compare.

Example: **ZT=0000**

SEND ALL SEARCH DATA RECORDS (Z-)

SYNTAX

<u>MEMORY INDICATOR</u>	<u>RECORD ID</u>	<u>RANGE SPECIFICATION</u>	<u>DATA</u>	
[A B]	{Z-}	NA	NA	{EOL}

Record Type - Request Only

The K105-D responds by sending the following data records:

ZR, ZT, ZF, ZL, ZC

ACQUISITION CONTROL (QQ)

SYNTAX

<u>MEMORY INDICATOR</u>	<u>RECORD ID</u>	<u>RANGE SPECIFICATION</u>	<u>DATA</u>
NA	{QQ}	NA	{=} { [A] [D] [S] [X] } {EOL}

Record Type - Command

The entries A, D, S and X correspond respectively to record keys on the machine as follows:

- A - Arm
- D - Advance
- S - Stop
- X - w/xfer

Example: QQ=A

CLEAR DISPLAY (DC)

SYNTAX

<u>MEMORY INDICATOR</u>	<u>RECORD ID</u>	<u>RANGE SPECIFICATION</u>	<u>DATA</u>
NA	{DC}	NA	{EOL}

Record Type - Command

The results of the record type request are shown only on the K105-D screen. DC followed by a carriage return clears the CRT screen. (This command enables the user to place his own messages on the screen, using record type DT.)

Example: DC

DEVICE CLEAR (KK)

SYNTAX

<u>MEMORY INDICATOR</u>	<u>RECORD ID</u>	<u>RANGE SPECIFICATION</u>	<u>DATA</u>
NA	{ KK }	NA	{ EOL }

Record Type - Command

Sending KK stops any recording in progress by the K105-D and except for the I/O screen, resets all setups and memories A and B to the powerup state.

Example: KK

DISPLAY SCREEN (DS)

SYNTAX

<u>MEMORY INDICATOR</u>	<u>RECORD ID</u>	<u>RANGE SPECIFICATION</u>	<u>DATA</u>	
NA	{ DS }	NA	{ = } { Screen } { Type }	{ EOL }

Record Type - Request and Setup

The results of the record type request are shown only on the K105-D CRT display. The following keys are used to actuate the different screens.

- A - Arm mode
- C - Clock
- D - Data
- F - Format
- G - Graph
- H - Histogram
- I - I/O Setup Screen
- M - Analysis Menu
- N - Noise Analysis
- O - Disk Operating System
- P - User's Guide
- R - Trace Control Review
- S - High Speed Setup
- T - Timing
- U - Auto Compare
- W - Wake Up
- X - Trace Control

Sending DS EOL returns the screen type.

Example: **DS=A**

DISPLAY TEXT ON CRT (DT)

SYNTAX

<u>MEMORY INDICATOR</u>	<u>RECORD ID</u>	<u>RANGE SPECIFICATION</u>	<u>DATA</u>
NA	{ DT }	NA	{ = } { INTEGER } { INTEGER } { ASCII STRING } { INTEGER } { EOL }

Record Type - Command

The first selected integer must be in the range of 01 through 29; this integer specifies the row on the current screen. The selected second and third integers must each be in the range of 01 through 52; these integers specify the column and length, respectively, on the current screen. The ASCII string selected must be in the range of 1 through 52 ASCII characters and specifies the message to be sent. The number of characters in the message must be equal to the specified length field.

Example: **DT=010304FROM**

K105-D CONFIGURATION (KC)

SYNTAX

<u>MEMORY INDICATOR</u>	<u>RECORD ID</u>	<u>RANGE SPECIFICATION</u>	<u>DATA</u>
NA	{KC}	NA	{EOL}

Record Type - Request Only

This record type can only be used to query the K105-D and the results are transmitted to the host.

The K105-D sends the current configuration of the K105-D. The first character specifies the Main channels; 0 specifies no Main channels; 1 specifies 32 Main channels; 2 specifies 64 channels. The second character specifies the High Speed channels; 0 specifies no High Speed channel; 1 specifies eight High Speed channels; 2 specifies sixteen High Speed channels.

Example: KC=21

SYNTAX

<u>MEMORY INDICATOR</u>	<u>RECORD ID</u>	<u>RANGE SPECIFICATION</u>	<u>DATA</u>
NA	{KT}	NA	{EOL}

Record Type - Request Only

The response to the record type request is a 12-digit numeric string.

The first eight digits are in binary form. These digits describe the GPIB status byte, beginning with the most significant bit, as follows:

- 7 - Recording in progress (armed but not stopped)
- 6 - SRQ - K105-D requests service
- 5 - Error in powerup diagnostics
- 4 - Listen Record error, rest of record ignored
- 3 - Interface error has occurred: No listeners active
- 2 - Acquisition control error ("ARM" control)
- 1 - Not used (always zero)
- 0 - Not used (always zero)

Note that Bits 2, 3 and 4 are cleared under the following conditions:

- The GPIB controller has completed a serial poll
- The KT status record has been sent

The 9th digit is in range of 0 through B and describes the main channel recording status, as follows:

- | | |
|----------|----------|
| 0 - RDY | 7 - LVL3 |
| 1 - WAIT | 8 - LVL4 |
| 2 - BUSY | 9 - LVL5 |
| 3 - CLK? | A - LVL6 |
| 4 - LVL0 | B - LVL7 |
| 5 - LVL1 | C - EOR |
| 6 - LVL2 | |

K105-D STATUS (KT) (Cont'd)

The tenth digit is in a range of 0 through 7 and describes the High Speed channel recording status, as follows:

- 0 - RDY
- 1 - BUSY
- 2 - CLK?
- 3 - LNK?
- 4 - TRG?
- 5 - DLY?
- 6 - EOR?
- 7 - EOR

The eleventh digit is in a range of 0 through 2 and indicates the selected memory, as follows:

- 0 - Memory M
- 1 - Memory A
- 2 - Memory B

The twelfth digit is either 0 or 1 and indicates Main or High Speed selected, respectively.

The K105-D requests service under the following conditions. The bit position in the GPIB status byte associated with each condition is indicated in parenthesis:

- a) At the end of the recording cycle (7)
- b) When the SRQ "key" (I/O [3] is pressed (6))
- c) At powerup
- d) When a listen record error occurs (4)
- e) When a GPIB interface error occurs (No listeners active) (3)
- f) When an acquisition control error occurs (2)

When the K105-D is not requesting service, a serial poll command returns the status byte that was returned when the K105-D previously requested service. The serial poll register is updated only when a service request is generated; therefore, the status byte may be incorrect. In this case, the KT record should be used, as it always returns the correct status byte.

Example: KT=001100000011

KEYSTROKES (\$+ or \$-)

SYNTAX

MEMORY INDICATOR	RECORD ID	RANGE SPECIFICATION	DATA	
NA	$\left\{ \begin{array}{l} [\$ + =] \\ [\$ - =] \end{array} \right\}$	NA	$\left\{ \text{INTEGER} \right\}$	$\left\{ \text{EOL} \right\}$

Record Type - Command

The results of the record type request are shown only on the K105-D CRT. This record type simulates depressing front-panel keys from remote.

Sending either \$+= or \$-= specifies normal or shifted, respectively, front-panel keys. The integer selected must be a two-digit number in the range of 01 through 48. This integer specifies the desired key on the front-panel, as follows:

01 - NEXT	02 - PREV	03 - FORMAT	04 - CLOCKS
05 - TRACE-CNTL	06 - ARM-MODE	07 - UP	08 - LEFT
09 - DATA	10 - TIMING	11 - GRAPH	12 - ANALYSIS
13 - RIGHT	14 - DOWN	15 - A/B	16 - MAIN/HS
17 - SEARCH	18 - COMPARE	19 - CURSOR-CNTL	20 - CURSOR-REF
21 - C	22 - 8	23 - 4	24 - 0
25 - SHIFT	26 - HELP	27 - D	28 - 9
29 - 5	30 - 1	31 - I/O	32 - SPACE
33 - E	34 - A	35 - 6	36 - 2
37 - EDIT	38 - INSERT	39 - F	40 - B
41 - 7	42 - 3	43 - ARM	44 - STOP
45 - F1	46 - F2	47 - F3	48 - F4

Example: \$-=26

MAIN/HIGH SPEED SELECT (MH)

SYNTAX

<u>MEMORY INDICATOR</u>	<u>RECORD ID</u>	<u>RANGE SPECIFICATION</u>	<u>DATA</u>	
NA	{ MH }	NA	{ = } { [M] } { [H] }	{ EOL }

Record Type - Command

Selecting M specifies the Main Channel displays; selecting H specifies the High Speed channel displays.

Example: MH=H

PRINT SCREEN DIRECT (PD)

SYNTAX

<u>MEMORY INDICATOR</u>	<u>RECORD ID</u>	<u>RANGE SPECIFICATION</u>	<u>DATA</u>
NA	{ PD }	NA	{ EOL }

Record Type - Request Only

Sending PD followed by a carriage return sends back to the terminal an exact copy of the current text on screen.

NOTE: This data stream is intended for a printer and will not be accepted by another K105-D.

Example: PD

```
                DISPLAY MAIN TIMING                CLK= 50 ^SEC
VERT =  8 TRACES          HORIZ =  X1          PAGE =  0
                                     C
      DF                      0
      DE                      0
      DD                      0
      DC                      0
      0                      511          1023
      DB                      0
      DA                      0
      D9
```

PRINT SCREEN LONG (PL)

SYNTAX

<u>MEMORY INDICATOR</u>	<u>RECORD ID</u>	<u>RANGE SPECIFICATION</u>	<u>DATA</u>
NA	{ PL }	NA	{ EOL }

Record Type - Request Only

Sending PL followed by a carriage return prints out trace control and data screens in their full length and entirety starting at the cursor.

When in other screens, sending PL returns a copy of the screen.

NOTE: This data stream is intended for a printer and will not be accepted by another K105-D.

Example: PL

I/O

GPIB		RS232	
MODE	= TALK ONLY	BAUD RATE	= 1200
GPIB ADDR.	= 00	WORD LENGTH	= 7 BITS
TERMINATOR	= CR/LF	STOP BIT(S)	= 1
EOI OUTPUT	= OFF	PARITY	= NONE
		PROTOCOL	= XON/XOFF

I/O - PORT = RS232
RECORD LENGTH = 80 CHARS.
COMMAND = SEND STATUS

SYNTAX

<u>MEMORY INDICATOR</u>	<u>RECORD ID</u>	<u>RANGE SPECIFICATION</u>	<u>DATA</u>
NA	{ PG }	NA	{ EOL }

Record Type - Request Only

The PG record type is used in an application where the K105-D is connected to a remote computer (host) which has a local FX-80 printer connected to it. For the host to upload the CRT image from the K105-D, and dump it to its local Epson FX-80 printer, it simply sends the PG record type followed by {end-of-line} (CR or CR/LF). The K105-D responds by sending back the following series of bytes:

{ eol }

{ ESC , '@' , ESC , 'A' , 8 }

37 times { ESC , '<' , ESC , 'K' , 160 , 1 , { 416 bytes } , CR , LF }

{ eol }

{ ESC , '@' }

TRANSFER SETUP MEMORIES BETWEEN M, A or B (TR)

SYNTAX

<u>MEMORY INDICATOR</u>	<u>RECORD ID</u>	<u>RANGE SPECIFICATION</u>	<u>DATA</u>
NA	{TR}	NA	{=} { [M] } { [A] } { [B] } { [M] } { [A] } { [B] } {EOL}

Record Type - Command

The first M, A or B sent specifies the memory buffer that data is to be taken from; the second M, A, or B sent specifies the destination that data is to be sent to.

The first and second character used cannot be the same for both entries.

Example: TR=AB

HISTOGRAM LEVEL SELECTION (XL)

SYNTAX

<u>MEMORY INDICATOR</u>	<u>RECORD ID</u>	<u>RANGE SPECIFICATION</u>	<u>DATA</u>
NA	{XL}	NA	{=} {INTEGER} ⁸

Record Type - Request and Setup

The selected integer must be either 0 or 1 and is sent eight times. These eight integers specify the trace levels for which a time interval histogram is made. The extreme left digit represents level 0 and the extreme right digit represents level 7.

where: 0 indicates level is not timed (-)
1 indicates level is timed (✓)

Example: **XL=01234567**

SEND ALL SETUP RECORDS (--)

SYNTAX

<u>MEMORY INDICATOR</u>	<u>RECORD ID</u>	<u>RANGE SPECIFICATION</u>	<u>DATA</u>	
$\begin{bmatrix} A \\ B \end{bmatrix}$	$\{--\}$	NA	NA	$\{EOL\}$

Record Type - Request Only

The K105-D responds by sending the following records:

CC, CS, CX, CD
FD, FT, FV, FP, FF, FL
TC, TN, TP, TV
RA, RM, RI, RP, RC
US, UA, UB, UL, UZ, UE
WS, WA, WB, WL, WZ, WE
NS, NB, NE, NC, ND
SS, SX, SD, SF, SC, ST, SP, SL, SI, XL

AN ILLUSTRATIVE TRACE RECORDING

GENERAL

This chapter presents the steps required to generate a simple trace recording using a target system based on the 8088 microprocessor. Because many types of microprocessors are available and the applications in which they are used are varied, the information contained in this chapter is intended to guide the user in the evaluation of the performed recording task.

RECORDING PREPARATION

The Unit Under Test (UUT) is an 8088 based training unit consisting of the CPU, a small amount of on-board RAM and ROM, a 16-digit alpha-numeric display, a Hex keypad and 16 command keys. The object of this exercise is to trace and record the instruction addresses relative to the interrogation of the command keys. Because the 8088 employs a time-multiplexed data/address bus, the K105-D must be operated in a demultiplex mode in order to record only instruction addresses. The user must examine the system timing charts pertinent to the CPU in use to determine which signals are suitable as clocks for the K105-D. Figure 6-1 illustrates the 8088 basic system timing. ALE occurs once only during T_1 time of each timing cycle; therefore, the rising edge of ALE, point 1, is the preferable choice as Master Clock for the K105-D. Further examination of figure 6-1 indicates all address lines are valid at the falling edge of ALE, point 2, which is the Sample point for instruction addresses. Figure 6-1 also shows Status, S_7-S_3 , and Data, D_7-D_0 , are valid at the rising edge of RD, INTA (or WR). Status can be sampled, and data demultiplexed at this time. Figure 6-2, the Clock Set Up screen, illustrates how the clocks may be selected to accomplish the recording task.

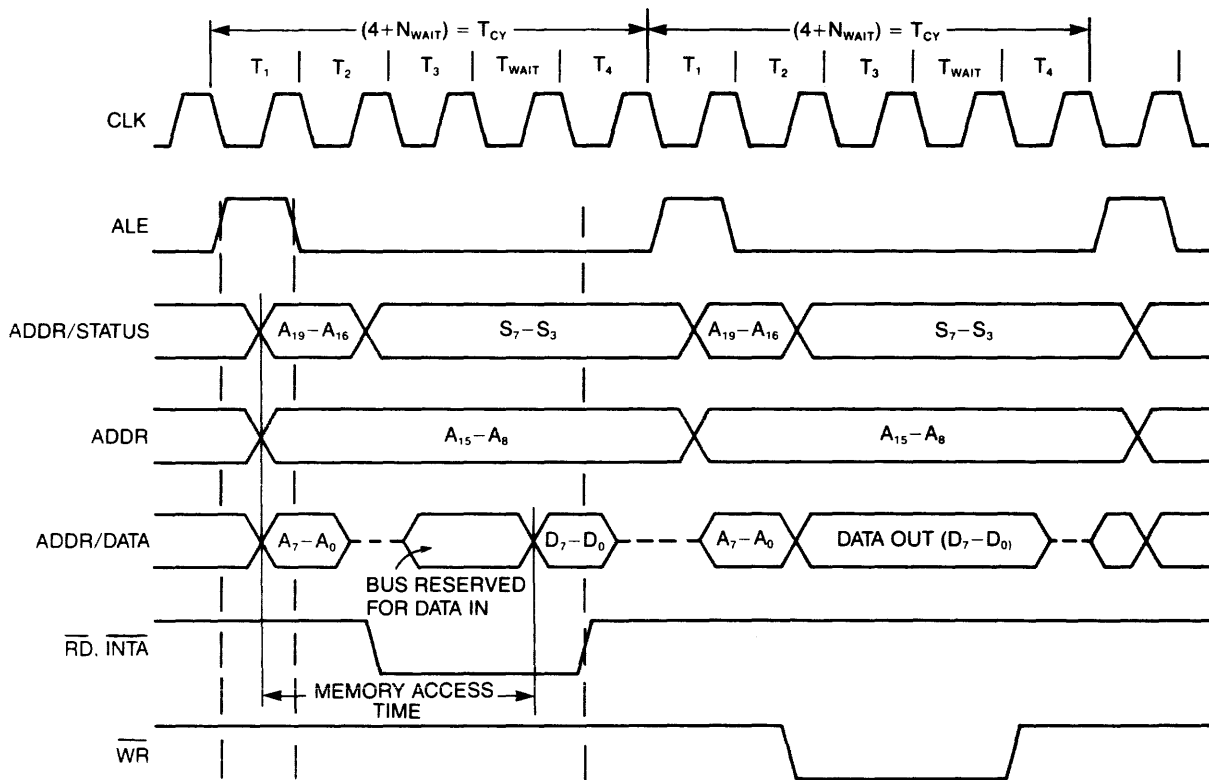

Figure 6-1. 8088 Basic System Timing

SET UP MAIN CLOCKS

CLOCK SOURCE = EXTERNAL MULTI-PHASED
MASTER CLOCK = ALE

SECTION D - SAMPLE ON SIGNAL 3
SECTION C - SAMPLE ON RDXR
SECTION B - SAMPLE ON RDXR
SECTION A - SAMPLE ON ALE

EXTERNAL CLOCK COMBINATION DEFINITIONS
NAME: CLOCK INPUTS:

ALE = ($\overline{D0} + \overline{D4} + \overline{D8} + \overline{D12}$) + ($\overline{D16} + \overline{D20} + \overline{D24} + \overline{D28}$)
RDXR = ($\overline{D0} + \overline{D4} + \overline{D8} + \overline{D12}$) + ($\overline{D16} + \overline{D20} + \overline{D24} + \overline{D28}$)
SIGNAL 2 = ($\overline{D0} + \overline{D4} + \overline{D8} + \overline{D12}$) + ($\overline{D16} + \overline{D20} + \overline{D24} + \overline{D28}$)
SIGNAL 3 = ($\overline{D0} + \overline{D4} + \overline{D8} + \overline{D12}$) + ($\overline{D16} + \overline{D20} + \overline{D24} + \overline{D28}$)

MEMORY=M MAIN
004-6-1

MAIN=RDY

Figure 6-2. Clock Set Up Screen for 8088 Recording

To accommodate the demultiplexed mode of operation, an external Multi-Phased Clock Source was selected. As previously mentioned, ALE is used as Master Clock. Referring to figure 6-2, note that ALE is the non-inverted CK input. The RD/WR signals are the inverted DK and DJ inputs, respectively. Section A is sampled at the falling edge of ALE, Section B is demultiplexed and Section C is sampled at the falling edge of RD/WR, after these signals have been inverted.

Figure 6-3 illustrates the connection of the K105-D probes to the 8088 CPU.

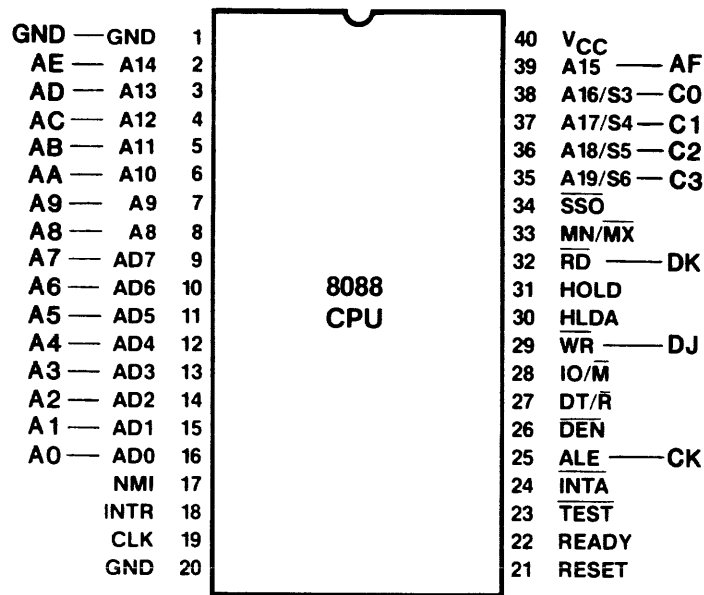

Figure 6-3. 8088 Pin Connections

Figure 6-4 provides a partial listing of the portion of the UUT program dealing with interrogation of the command keys. The instruction addresses are located to the extreme left of the figure; immediately to their right is the data for the addresses. When setting up the Format Set Up screen, the user should attempt to select a format similar to that of the listing.

```

C18E 8AC7          565  NEWCM:  MOV    AL,BH          ;GOT HERE VIA AN ABORTED INPUT
C190              566  NEWCMD:
                    567  ;
                    568  ;THIS ROUTINE CHECK FOR KEYS IN THE RANGE OF 10-1FH ,30H,34H,41H
                    569  ;IF KEY NOT IN THIS RANGE THEN INVALID COMMAND IS DISPLAYED
                    570  ;
C190 3C41          571  CKKEY:  CMP    AL,PORK
C192 7503          572          JNE    CKKEY1
C194 E964FF        573          JMP    INIT          ;IF POR THEN INIT
C197 3C30          574  CKKEY1: CMP    AL,WBK
C199 7502          575          JNE    CKKEY2
C19B B014          576          MOV    AL,14H          ;SET JUMP TAB INDEX
C19D 3C34          577  CKKEY2: CMP    AL,HMK
C19F 7502          578          JNE    CKKEY3
C1A1 B01C          579          MOV    AL,10H
C1A3 3C10          580  CKKEY3: CMP    AL,10H
C1A5 7204          581          JB    BADCM          ;KEY VAL IS 0-F
C1A7 3C20          582          CMP    AL,20H
C1A9 7207          583          JB    CKKEY4          ;KEY IS VALID
                    584  ;
                    585  ;THIS ROUTINE DISPLAYS INVALID COMMAND
                    586  ;
C1AB B008          587  BADCM:  MOV    AL,MSG9
C1AD E80000        E 588          CALL  DISPCM
C1B0 EBCE          589          JMP    ABORT
                    590  ;
C1B2 250F00        591  CKKEY4: AND    AX,0FH          ;MASK
C1B5 D1E0          592          SHL    AX,1
C1B7 83D8          593          MOV    BX,AX
C1B9 8E06B8FF      R 594          MOV    ES,USEG
C1BD 2EFA7C2C1    R 595          JMP    CS:CM1JMP [BX] ;GO DO FUNCTION
                    596  ;

```

Figure 6-4. 8088 Program Listing

Figure 6-5 depicts the Format Set Up screen as configured for this application. The extreme left Hex column presents the C(3-0) inputs which are connected, respectively, to the S(6-3) outputs of the 8088. The A(F-C), A(B-8), A(7-4) and A(3-0) inputs are connected to the A15 through A8 and AD7 through AD0 pins of the 8088, as shown in figure 6-3. These four columns represent the sampled instruction. On a demultiplex function, the information present on the AD7 through AD0 pins of the 8088 is latched in the K105-D and displayed as the B(7-4) and B(3-0) columns (the data).

```

                SET UP  MAIN FORMAT

DATA FORMAT USER SPECIFIED

RADIX       H  HH  HH  HH

SECTION    C  AA  AA  BB

INPUTS     3  FB  73  73
           2  EA  62  62
           1  D9  51  51
           0  C8  40  40

-----
DATA INPUTS      THRESHOLD      POLARITY
DF-D8           TTL             + 1.4      +++++ +++++
D7-D0           TTL             + 1.4      +++++ +++++
CF-C8           TTL             + 1.4      +++++ +++++
C7-C0           TTL             + 1.4      +++++ +++++
BF-B8           TTL             + 1.4      +++++ +++++
B7-B0           TTL             + 1.4      +++++ +++++
AF-A8           TTL             + 1.4      +++++ +++++
A7-A0           TTL             + 1.4      +++++ +++++
CLOCK INPUTS    TTL             + 1.4      +++++ +++++

[F1]-DATA FORMAT, [F2]-TOP THRESHOLD
MEMORY=M MAIN
004-6-2
                MAIN=RDY

```

Figure 6-5. Format Set Up Screen

With the setup illustrated in figure 6-5, the data is displayed in a format similar to the listing illustrated in figure 6-4.

Figure 6-6, the Trace Set Up screen, depicts the trace control setup used for this recording. At level 0, the K105-D is instructed to trace until the sample equals Enable. Enable is described in the pattern definitions as X C1 8E XX. Upon recognition of Enable, trace control advances to level 1 and trace continues for another 500 clocks.

```
                SET UP MAIN TRACE

LVL  COMMAND SEQUENCE:
0: TRACE UNTIL SAMPLE = ENABLE
1: TRACE FOR 00500 CLOCKS
-----
-----
-----

PATTERN DEFINITIONS:
NAME:      H HH HH HH
00 ENABLE  =X C1 8E XX
01 TRIGGER =X XX XX XX
02 _       =X XX XX XX

[F1]→TOP CMD, [F2]→TOP PTRN
MEMORY=M MAIN                                MAIN=RDY
004-6-3
```

Figure 6-6. Trace Set Up Screen

As shown in figure 6-7, the arm mode is set for manual arming of the main inputs with auto-flush.

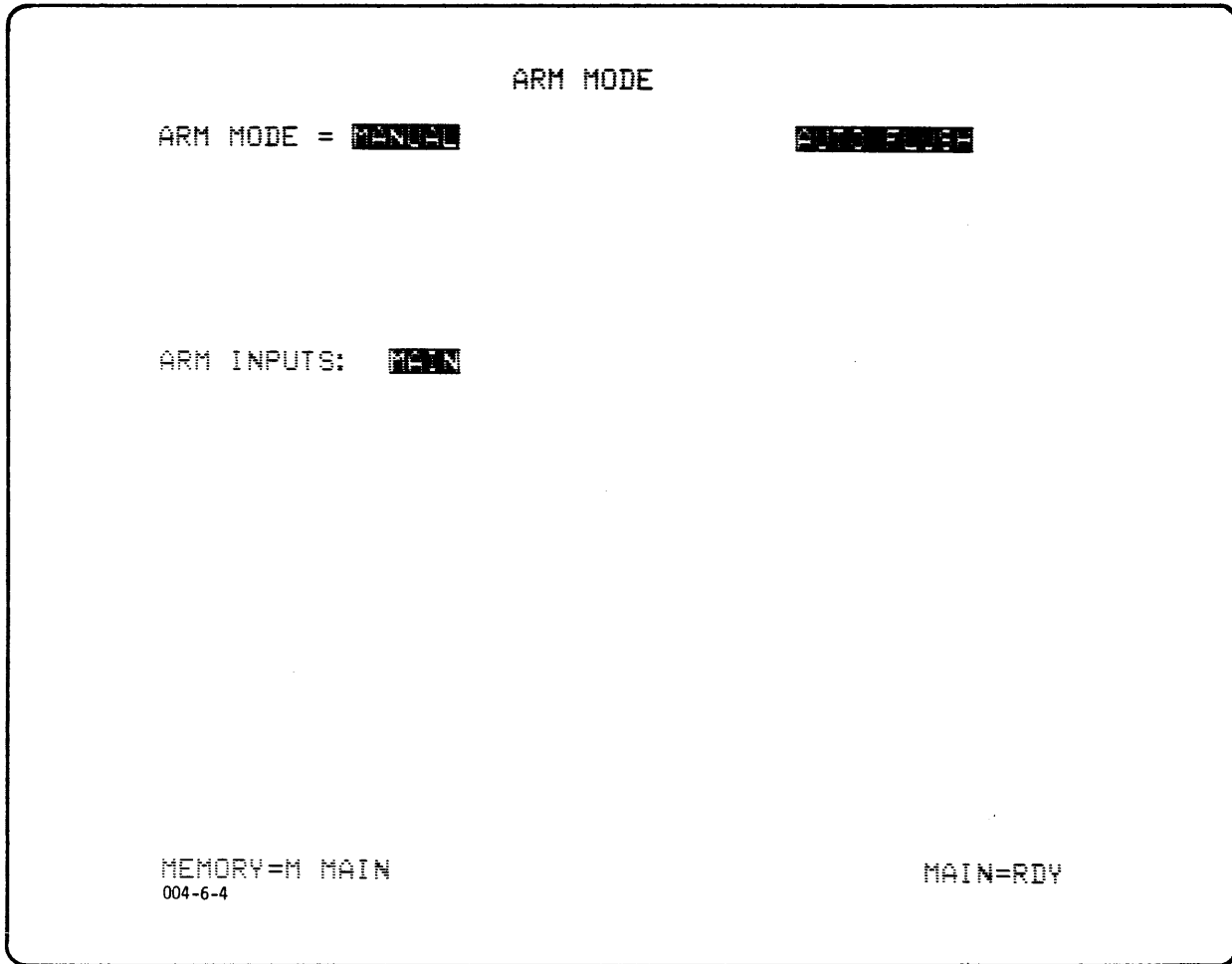

Figure 6-7. Arm Mode Set Up Screen

As this trace recording task is a simple procedure, only the upper portion of the Arm Mode Set Up screen is utilized. Upon completion of the previously mentioned screen setups, the user accesses the Data Display screen, starts operation of the UUT and depresses the ARM key. The data presented for the trace is as shown in figure 6-8.

```

                DISPLAY MAIN DATA                CLK= 50 nSEC

SEARCH = X X C1 8E XX
          L H HH HH HH
C 0000   0 2 CE FE 8A          0021   0 2 CE FB DE
   0001   0 2 00 DE 0C          0022   0 2 CE FC 00
   0002   0 2 CE FF E0          0023   0 2 CE FD EC
   0003   0 2 CF 00 24          0024   0 2 CE FE 8A
   0004   0 2 CF 01 01          0025   0 2 00 DE 0C
   0005   0 2 CF 02 74          0026   0 2 CE FF E0
   0006   0 2 CF 03 F6          0027   0 2 CF 00 24
   0007   0 2 CF 04 BA          0028   0 2 CF 01 01
   0008   0 2 CE FA BA          0029   0 2 CF 02 74
   0009   0 2 CE FB DE          0030   0 2 CF 03 F6
   0010   0 2 CE FC 00          0031   0 2 CF 04 BA
   0011   0 2 CE FD EC          0032   0 2 CE FA BA
   0012   0 2 CE FE 8A          0033   0 2 CE FB DE
   0013   0 2 00 DE 0C          0034   0 2 CE FC 00
   0014   0 2 CE FF E0          0035   0 2 CE FD EC
   0015   0 2 CF 00 24          0036   0 2 CE FE 8A
   0016   0 2 CF 01 01          0037   0 2 00 DE 0C
   0017   0 2 CF 02 74          0038   0 2 CE FF E0
   0018   0 2 CF 03 F6          0039   0 2 CF 00 24
   0019   0 2 CF 04 BA          0040   0 2 CF 01 01
   0020   0 2 CE FA BA          0041   0 2 CF 02 74

SEARCH TOTAL "*" = 0001      FIRST=0521      LAST=
CONTROL=0000      REF=1023      R-C=+1023 (51.15 nS)
[F1]=PAGE UP, [F2]=PAGE DOWN - USE EDIT TO CHANGE SEARCH
MEMORY=A MAIN      MAIN-RDY

004-6-5

```

Figure 6-8. Traced Data

A search word of X C1 8E XX is entered on the screen. This search word represents the beginning of the program routine to be examined. Depressing the SEARCH key causes the display to indicate the first (and for this exercise the only) occurrence of the search word within the trace. By using the NEXT key, the user can immediately advance to location 0521, the location of the searched word. The Data Display screen now appears as shown in figure 6-9. The leftmost hex column indicates the 8088 segment register presently used for data accessing. The remaining hex columns are comparable to the address and data columns in figure 6-4, the program listing.

DISPLAY MAIN DATA

CLK= 50 μ SEC

```

SEARCH = X X C1 8E XX
        L H HH HH HH
0520   0 2 C7 53 80
C 0521 * 0 2 C1 8E 8A
0522   0 2 C1 8F C7
0523   1 2 C1 90 3C
0524   1 2 C1 91 41
0525   1 2 C1 92 75
0526   1 2 C1 93 03
0527   1 2 C1 94 E9
0528   1 2 C1 97 3C
0529   1 2 C1 98 30
0530   1 2 C1 99 75
0531   1 2 C1 9A 02
0532   1 2 C1 9B B0
0533   1 2 C1 9D 3C
0534   1 2 C1 9E 34
0535   1 2 C1 9F 75
0536   1 2 C1 A0 02
0537   1 2 C1 A1 B0
0538   1 2 C1 A3 3C
0539   1 2 C1 A4 10
0540   1 2 C1 A5 72
0541   1 2 C1 A6 04
0542   1 2 C1 A7 3C
0543   1 2 C1 A8 20
0544   1 2 C1 A9 72
0545   1 2 C1 AA 07
0546   1 2 C1 AB B0
0547   1 2 C1 B2 25
0548   1 2 C1 B3 0F
0549   1 2 C1 B4 00
0550   1 2 C1 B5 D1
0551   1 2 C1 B6 E0
0552   1 2 C1 B7 8B
0553   1 2 C1 B8 D8
0554   1 2 C1 B9 8E
0555   1 2 C1 BA 06
0556   1 2 C1 BB B8
0557   1 2 C1 BC FF
0558   1 2 C1 BD 2E
0559   1 3 FF B8 00
0560   1 3 FF B9 00
0561   1 2 C1 BE FF
SEARCH TOTAL "*" = 0001      FIRST=0521      LAST=
CONTROL=0521      REF=1023      R-C=+ 502 (25.10  $\mu$ S)
[F1]=PAGE UP, [F2]=PAGE DOWN - USE EDIT TO CHANGE SEARCH
MEMORY=A MAIN      MAIN=RDY
    
```

004-6-6

Figure 6-9. Searched Data

OPTIONS INSTALLATION

GENERAL

This chapter describes procedures for installing various optional equipment on the K105-D. This optional equipment is provided in kit form for users who desire to expand the operating capabilities of their equipment. Once installed, the K105-D will automatically recognize its new hardware configuration when powered up. The Display Options Screen will indicate the new hardware options available for the user and the system will respond appropriately. The following kits are available:

- High-Speed Lower Bits Kit, Part Number 0117-0800-20
- High-Speed Upper Bits Kit, Part Number 0117-0810-20
- 32 Main Input Lower Bits Kit, Part Number 0117-3200-20
- 32 Main Input Upper Bits Kit, Part Number 0117-3210-20
- DOS Kit, Part Number 0117-0167-20

Each kit contains installation instructions for the equipment option. Internal wiring harness assemblies that interface with optional printed circuit board connectors, are installed in the K105-D chassis by the factory to facilitate the addition of options by the user. These harness assemblies are located at the upper right-hand side of the card cage. Individual cables contained within the harness are labeled for identification and the entire bundle of cables is exposed when the top cover is removed from the K105-D chassis.

The DOS Option Kit includes a power cable assembly and signal cable assembly that must be installed by the user. The associated diagrams and wiring details are contained in the installation procedure.

The installation procedure for each option kit is described in subsequent sections of this chapter. The DOS functional description and operation are described in a separate K105-D User's Manual Addendum, Publication Number 0117-0256-10, which is included in the kit.

```
* * * * *
*
*           WARNING
*
* Disconnect the 115VAC source
* to the K105-D prior to in-
* stalling any options; other-
* wise, a shock hazard exists.
*
* * * * *
```

CARD CAGE ARRANGEMENT

The card cage arrangement is shown in Figure 7-1. Each card slot is labeled to indicate the required card location. For the most part, the assigned board is dedicated to reside in its assigned slot location except where noted below for the HI-SPEED/DATA slot.

The various input configurations of the K105-D are established by the installation of cards in the following slot locations:

- HIGH-SPEED slot -- accepts only the High-Speed Lower Bits Option Card which supplies low-order bits, 7-0 inputs.
- *HI-SPEED/DATA slot -- accepts either the High-Speed Upper Bits Option Card which supplies high-order bits, F-8 inputs, (or)
 - accepts the 32 Main Input Upper Bits Option Card which supplies high-order bits, F-8 input.
- DATA slot -- accepts only the 32 Main Input Lower Bits Option Card which supplies low-order bits, 7-0 Input.

*NOTE: The High Speed Lower Bits Option Card must also be present if the High Speed Upper Bits Option Card is used.
(or)
Likewise, the 32 Main Input Lower Bits Option Card must also be present if the 32 Main Input Upper Bits Option Card is used.

The installed cards are secured in the card cage by a slotted retainer bar which is fastened to the top of the card cage by two screws.

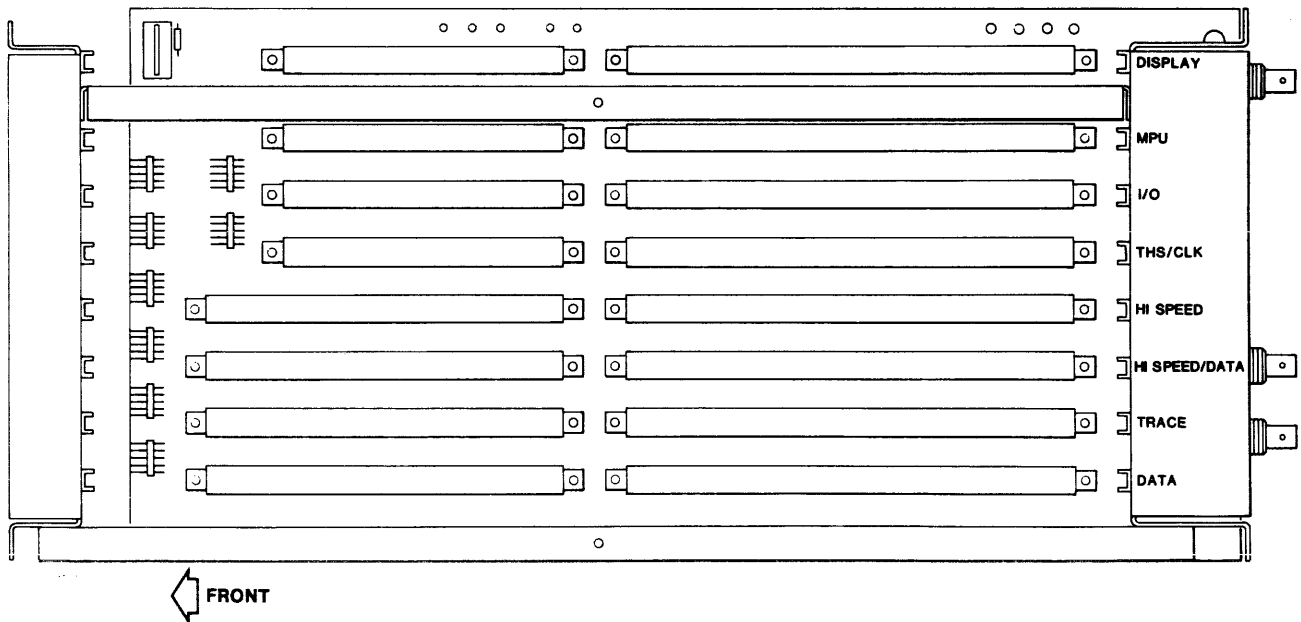

Figure 7-1. K105-D Card Cage Arrangement

INSTALLATION OF HIGH SPEED LOWER BITS OPTION

Unpacking and Inspection

The High-Speed Lower Bits Option provides 8 inputs (bits 7-0) for the high speed (HS) channel. All hardware items required to install and operate this option at the user's site are shipped in packaged units. External cables are included for connecting all components in the system. All items shipped for the system configuration are described in Table 7-1.

Table 7-1. High Speed Lower Bits Option Components

PART NUMBER	DESCRIPTION
0117-0070-10	High-Speed Printed Circuit Board Assembly
0117-0173-35	6 Foot, High Speed Clock Probe
0114-1071-10	Grabber Set
0117-0294-30	Input Cable Set
0117-0302-10	Instruction Sheet
0117-0216-10	Probe Pouch

All equipment was thoroughly inspected and checked out at the factory prior to packaging for shipment. After removing the equipment from its shipping container, inspect for scratches, dents or other damage that might have occurred during shipping. Refer to the shipping papers to verify that all items were received.

If equipment received from the carrier is incomplete or damaged, do not install the equipment. File a claim with the shipping firm immediately, and notify Gould Inc., Design and Test Systems Division Customer Service department at once. Gould Inc., Design and Test Systems Division will arrange for repair or replacement of the equipment without waiting for settlement of the claim against the carrier.

Installation

Prior to beginning the option installation, position the carrying handle of the K105-D to the front of the machine so that the unit rests flat on the work surface.

```
* * * * *
*           WARNING           *
*                               *
* Disconnect the 115 VAC source *
* to the K105-D prior to installing *
* any options; otherwise, a shock *
* hazard exists.              *
*                               *
* * * * *
```

The following steps outline the procedure necessary to install the High Speed lower bits option board in the K105-D units that do not contain the DOS option. If the DOS Option is present in lieu of the top cover, refer to the DOS Option Removal Procedure at the end of this section.

1. Remove the six Phillips-head screws securing the top cover, and carefully lift it from the unit.
2. Remove the two screws that secure the card retainer bar to the top of the card cage and lift it from the chassis.
3. Examine the option board and ensure that the coaxial cable connecting J4 to J5 is present and the plugs are securely seated into their sockets. Orient the board with the solder side toward the power supply of the unit. Carefully insert the board into the card slot designated HI-SPEED.

```
* * * * *
*           CAUTION           *
*                               *
* Do not allow the coaxial jumper *
* cable to become entangled with an *
* adjacent board.                *
*                               *
* * * * *
```

Do not engage the board into the motherboard socket at this time.

4. Referring to Figure 7-2, locate the two unattached ribbon cables labeled HS CLK. Lift the board approximately an inch and install the larger ribbon cable connector on J1. The dark-brown wire braid on the connector should be located to the front of the machine. (NOTE: If J1 is installed backwards, equipment will not be damaged; however, the data at channel 0 will be displayed on channel 7. Reversing the connector will correct the condition.) Next, install the smaller ribbon cable connectors on J2 and J3. They should be connected as shown in Figure 7-2 with the intermediate connector on J2 and the end connector on J3. The engraved arrows at J2 and J3 should be located to the rear of the unit.

Installation (cont'd.)

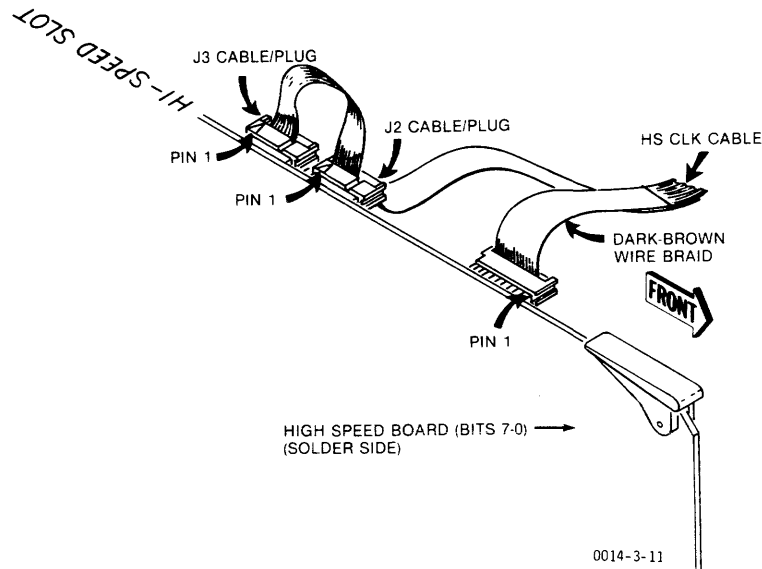

Figure 7-2. Ribbon Cable Connections, High-Speed Input Lower Bits Option

5. By pressing down firmly on the board ejector tabs, engage the board into the motherboard socket. Replace the card cage retainer bar and secure with two screws.
6. Ensure that the ribbon cables are properly dressed and do not interfere with reinstallation of the top cover. Reinstall the top cover.
7. Reinstall the six retaining screws.
8. Reconnect the 115 VAC source to the K105-D.

Removal of DOS Option Assembly

The DOS assembly may be removed from the K105-D chassis to gain access to the card cage or other components. Use the following procedure to accomplish the removal.

1. Remove the four Phillips-Head screws securing the top cover to the DOS assembly, and carefully lift the top cover from the DOS housing.

Removal of DOS Option Assembly (cont'd.)

2. Remove the two screws that secure the DOS base and ground connection lug to the top of the K105-D chassis.
3. Remove four screws (2 on each side) that secure the DOS assembly to the K105-D chassis.

NOTE: It is not necessary to disconnect the power harness and I/O ribbon cables from the drives during removal if the unit is to be reassembled.

4. Carefully lift the DOS assembly from the K105-D chassis and store the unit (with attached cables) to the left side of the K105-D chassis.
5. Position the DOS assembly on its side and ensure that the attached cables do not bind or otherwise interfere with internal components in the K105-D chassis.
6. Reinstall the DOS assembly by reversing the removal procedure. Ensure that the I/O signal cable is properly folded at a 45° angle at the I/O board connector (J1) so that it does not bind, nor interfere with other internal components, when the DOS assembly is positioned on top of the K105-D chassis.

INSTALLATION OF HIGH SPEED UPPER BITS OPTION

Unpacking and Inspection

The Hi-Speed Upper Bits Option provides 8 inputs (bits F-8) for the high speed (HS) channel. All hardware items required to install and operate this option at user's site are shipped in packaged units. External cables are included for connecting all components in the system. All items shipped for the system configuration are described in Table 7-2.

Table 7-2. High Speed Upper Bits Option Components

PART NUMBER	DESCRIPTION
0117-0070-10	High Speed Printed Circuit Board Assembly
0117-0173-35	6 Foot, High Speed Clock Probe
0114-1071-10	Grabber Set
0117-0224-10	Input Cable Set
0117-0303-10	Instruction Sheet
0117-0216-10	Probe Pouch

All equipment was thoroughly inspected and checked out at the factory prior to packaging for shipment. After removing the equipment from its shipping container, inspect for scratches, dents or other damage that might have occurred during shipping. Refer to the shipping papers to verify that all items were received.

Installation

If equipment received from the carrier is incomplete or damaged, do not install the equipment. File a claim with the shipping firm immediately, and notify Gould Inc., Design and Test Systems Division Customer Service department at once. Gould Inc., Design and Test Systems Division will arrange for repair or replacement of the equipment without waiting for settlement of the claim against the carrier.

Prior to beginning the option installation, position the carrying handle of the K105-D to the front of the machine so that the unit rests flat on the work surface.

NOTE: The High-Speed Lower Bits Option board must be present in the unit to interface with the High-Speed Upper Bits Option board.

```
* * * * *
*           WARNING           *
* * * * *
* Disconnect the 115 VAC source *
* to the K105-D prior to installing *
* any options; otherwise, a shock *
* hazard exists.             *
* * * * *
* * * * *
```

Installation (cont'd.)

The following steps outline the procedure necessary to install the High Speed upper bits option board in the K105-D units not configured with the DOS option. If the DOS option is present in lieu of the top cover, refer to the DOS Option Removal procedure at the end of this section.

1. Remove the six Phillips-head screws securing the top cover, and carefully lift it from the unit.
2. Remove the two screws that secure the card retainer bar to the top of the card cage and lift it from the chassis.
3. Examine the option board and ensure that the coaxial cable connecting J4 to J5 is present, and remove the J4 coaxial cable plug from the J4 socket.
4. Locate the High Speed Lower Bits option board residing in the HI-SPEED card slot of the chassis. Using the board ejector tabs, extract the board from its motherboard socket. Lift the board approximately an inch and remove the ribbon cable connectors from J1, J2 and J3. Remove the board from the unit.

```
* * * * *
*           CAUTION           *
*                               *
* Do not allow the coaxial jumper *
* cable to become entangled with *
* an adjacent board.           *
*                               *
* * * * *
```

5. Place the board flat on a work surface, solder side down. Remove the J5 coaxial cable plug from the J5 socket. Carefully place the new High Speed option board on top of and slightly overlapping the board just removed from the unit. Both boards should be solder side down, top to top orientation and J4 and J5 sockets of both boards exposed. Connect the coaxial cables so that J4 of one board connects to J5 of the other board; in other words, the cables should cross each other.
6. Carefully grasp both boards and place them into the machine; one board in the HI-SPEED card slot, the other in the HI-SPEED/DATA card slot. The boards must be oriented with the solder side toward the power supply. Do not engage the boards into the mother board sockets at this time.

Installation (cont'd.)

7. The board in the HI-SPEED card slot is the HI-Speed Lower Bits circuit board. Referring to Figure 7-3, locate the large and small unattached ribbon cables designated HS CLK and the small ribbon cable in the HS HS F-8 bundle. Note that the small ribbon cables each have two connectors. Raise the High Speed Lower Bits board approximately an inch and connect the large ribbon cable connector to J1. The engraved arrow on the connector should be oriented toward the front of the unit. Connect the intermediate connector of the small ribbon cable designated HS CLK to J2. The engraved arrow on the connector should be oriented toward the rear of the machine, and the end connector of the cable should be hanging loose. Next, connect the end connector of the small ribbon cable of the HS F-8 bundle to J3. The engraved arrow on the connector should be oriented toward the rear of the unit, and the intermediate connector left unattached.
8. Release the High Speed Lower Bits board, and raise the High Speed Upper Bits board approximately an inch. Connect the connector of the large ribbon cable labeled HS F-8 to J1. The dark-brown wire braid on connector J1 must be oriented toward the front of the machine. All other connectors to be attached to this board must be oriented with the engraved arrow on the connector toward the rear of the unit. Fold the end connector of ribbon cable HS CLK over from its J2 connection to the adjacent High Speed board and attach it to J2 of this board. Attach the intermediate connector of the HS F-8 ribbon cable to J3 of this board.
9. By pressing down firmly on the board ejector tabs, engage both boards into their motherboard sockets. Replace the card cage retainer bar and secure with two screws.
10. Ensure that all cables are properly dressed and do not interfere with reinstallation of the top cover. Reinstall the top cover.
11. Reinstall the six retaining screws.
12. Reconnect the 115 VAC source to the K105-D.

Removal of DOS Option Assembly

The DOS assembly may be removed from the K105-D chassis to gain access to the card cage or other components. Use the following procedure to accomplish the removal.

1. Remove the four Phillips-Head screws securing the top cover to the DOS assembly, and carefully lift the top cover from the DOS housing.
2. Remove the two screws that secure the DOS base and ground connection lug to the top of the K105-D chassis.
3. Remove four screws (2 on each side) that secure the DOS assembly to the K105-D chassis.

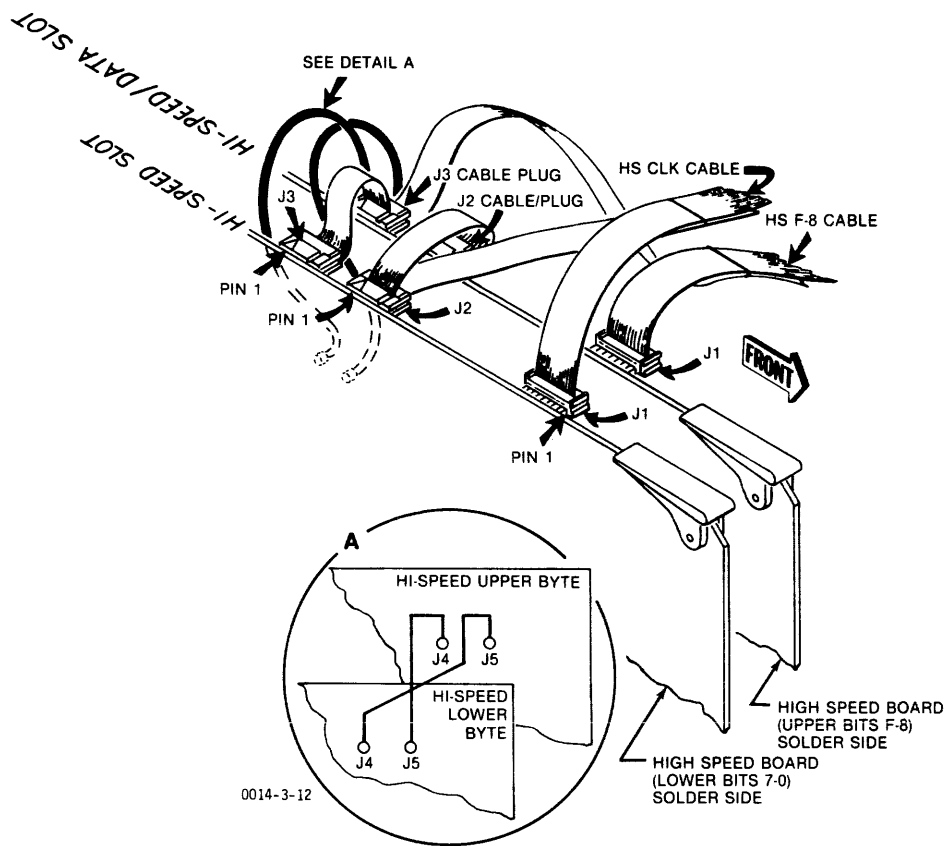

Figure 7-3. Ribbon Cable Connections, High Speed Input Upper Bits Option

Removal of DOS Option Assembly (cont'd.)

NOTE: It is not necessary to disconnect the power harness and I/O ribbon cables from the drives during removal if the unit is to be reassembled.

4. Carefully lift the DOS assembly from the K105-D chassis and store the unit (with attached cables) to the left side of the K105-D chassis.
5. Position the DOS assembly on its side and ensure that the attached cables do not bind or otherwise interfere with internal components in the K105-D chassis.
6. Reinstall the DOS assembly by reversing the removal procedure. Ensure that the I/O signal cable is properly folded at a 45° angle at the I/O board connector (J1) so that it does not bind, nor interfere with other internal components, when the DOS assembly is positioned on top of the K105-D chassis.

Installation (cont'd.)

The following steps outline the procedure necessary to install the 32 Input lower bits option board in the K105-D units not configured with the DOS Option. If the DOS Option is present in lieu of the top cover, refer to the DOS Option Removal procedure at the end of this section.

1. Remove the six Phillips-head screws securing the top cover, and carefully lift it from the unit.
2. Remove the two screws that secure the card retainer bar to the top of the card cage and lift it from the chassis.
3. Orient the Trace Control board (Part Number 0117-0060-10) with the solder side toward the power supply of the unit. Carefully insert the board into the card slot designated TRACE.
4. Referring to Figure 7-4, insert the Data board (Part Number 0117-0145-10) into the slot labeled DATA. The solder side of the board should be oriented toward the power supply. Locate the unattached ribbon cables designated A CLKJ, K, 7-0, B CLKJ, K, 7-0, C CLKJ, K, 7-0 and D CLKJ, K, 7-0. Attach the ribbon cables as follows:
 - A CLK cable to the JA board connector
 - B CLK cable to the JB board connector
 - C CLK cable to the JC board connector
 - D CLK cable to the JD board connector
5. By pressing down firmly on the board ejector tabs, engage the boards into their motherboard sockets. Replace the card cage retainer bar and secure with two screws.
6. Ensure that the ribbon cables are properly dressed and do not interfere with reinstallation of the top cover. Reinstall the top cover.
7. Reinstall the six retaining screws.
8. Reconnect the 115 VAC source to the K105-D.

Removal of DOS Option Assembly

The DOS assembly may be removed from the K105-D chassis to gain access to the card cage or other components. Use the following procedure to accomplish the removal.

1. Remove the four Phillips-Head screws securing the top cover to the DOS assembly, and carefully lift the top cover from the DOS housing.
2. Remove the two screws that secure the DOS base and ground connection lug to the top of the K105-D chassis.
3. Remove four screws (2 on each side) that secure the DOS assembly to the K105-D chassis.

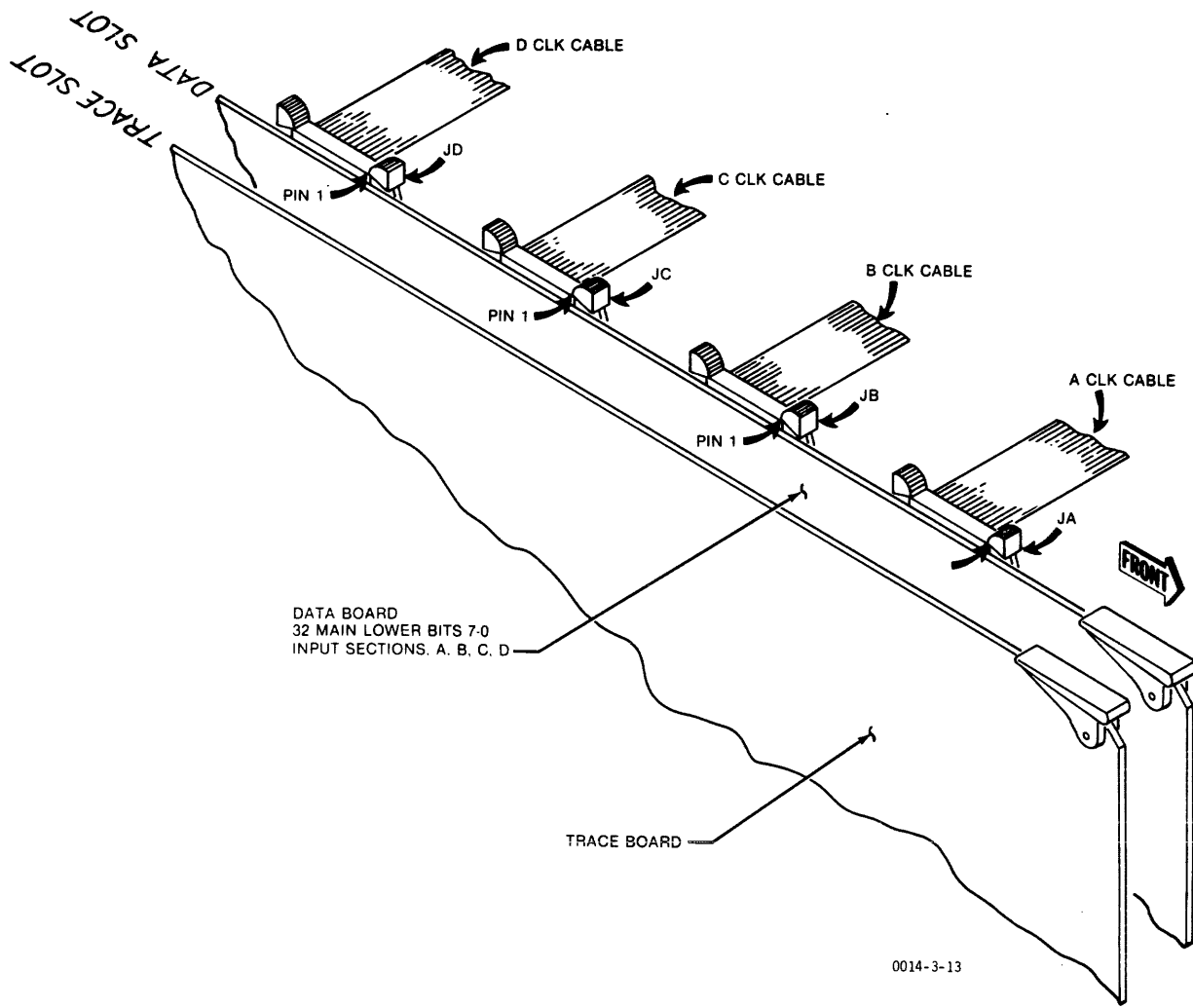

Figure 7-4. 32 Main Input Lower Bits Option, Ribbon Cable Connections

Removal of DOS Option Assembly (cont'd.)

NOTE: It is not necessary to disconnect the power harness and I/O ribbon cables from the drives during removal if the unit is to be reassembled.

4. Carefully lift the DOS assembly from the K105-D chassis and store the unit (with attached cables) to the left side of the K105-D chassis.
5. Position the DOS assembly on its side and ensure that the attached cables do not bind or otherwise interfere with internal components in the K105-D chassis.
6. Reinstall the DOS assembly by reversing the removal procedure. Ensure that the I/O signal cable is properly folded at a 45° angle at the I/O board connector (J1) so that it does not bind, nor interfere with other internal components, when the DOS assembly is positioned on top of the K105-D chassis.

INSTALLATION OF 32 MAIN INPUT UPPER BITS OPTION

Unpacking and Inspection

The 32 Main Input Upper Bits Option provides 8 bits (F-8) for each section input at channels A, B, C and D. All hardware items required to install and operate this option at the user's site are shipped in packaged units. External cables are included for connecting all components in the system. All items shipped for the system configuration are described in Table 7-4.

Table 7-4. 32 Main Input Upper Bits Option Components

PART NUMBER	DESCRIPTION
0117-0145-10	Data Printed Circuit Board Assembly
0117-0173-40	6 Foot A F-8 Probe
0117-0173-45	6 Foot B F-8 Probe
0117-0173-50	6 Foot C F-8 Probe
0117-0173-55	6 Foot D F-8 Probe
0114-1071-10	Grabber Set (Quantity - 4)
0117-0224-10	Input Cable Set (Quantity - 4)
0117-0301-10	Instruction Sheet
0117-0216-10	Probe Pouch

All equipment was thoroughly inspected and checked out at the factory prior to packaging for shipment. After removing the equipment from its shipping container, inspect for scratches, dents or other damage that might have occurred during shipping. Refer to the shipping papers to verify that all items were received.

If equipment received from the carrier is incomplete or damaged, do not install the equipment. File a claim with the shipping firm immediately, and notify Gould Inc., Design and Test Systems Division Customer Service department at once. Gould Inc., Design and Test Systems Division will arrange for repair or replacement of the equipment without waiting for settlement of the claim against the carrier.

Installation

Prior to beginning the option installation, position the carrying handle of the K105-D to the front of the machine so that the unit rests flat on the work surface.

NOTE: The 32 Main Inputs Lower Bits Option board must be present in the unit to interface with the 32 Main Inputs Upper Bit Option board.

Installation (cont'd.)

```
* * * * *  
*           WARNING           *  
* * * * *  
* Disconnect the 115 VAC source *  
* to the K105-D prior to installing *  
* any options; otherwise, a shock *  
* hazard exists.              *  
* * * * *  
* * * * *
```

The following steps outline the procedure necessary to install the 32 Input upper bits option board in the K105-D units not configured with the DOS option. If the DOS Option is present in lieu of the top cover, refer to the DOS Option Removal procedure at the end of this section.

1. Remove the six Philips-head screws securing the top cover, and carefully lift it from the unit.
2. Remove the two screws that secure the card retainer bar to the top of the card cage and lift it from the chassis.
3. Referring to Figure 7-5, insert the Data board (Part Number 0117-0145-10) into the slot labeled HIGH SPEED/DATA. The solder side of the board should be oriented toward the power supply. Locate the unattached ribbon cables designated A F-8, B F-8, C F-8 and D F-8. Attach the ribbon cables as follows:
 - A F-8 cable to the JA board connector
 - B F-8 cable to the JB board connector
 - C F-8 cable to the JC board connector
 - D F-8 cable to the JD board connector
4. By pressing down firmly on the board ejector tabs, engage the boards into their motherboard sockets. Replace the card cage retainer bar and secure with two screws.
5. Ensure that the ribbon cables are properly dressed and do not interfere with reinstallation of the top cover. Reinstall the top cover.
6. Reinstall the six retaining screws.
7. Reconnect the 115 VAC source to the K105-D.

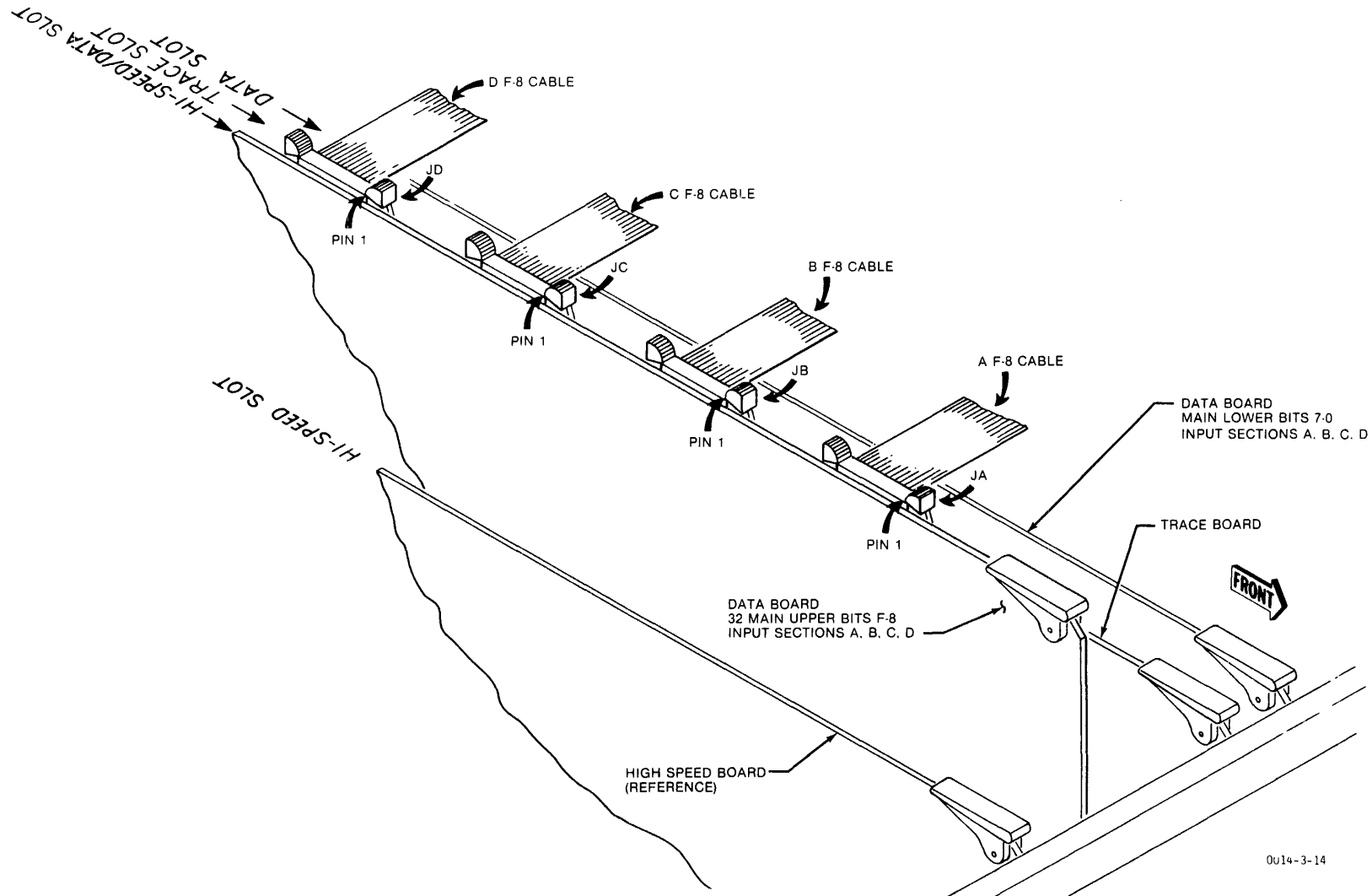

Figure 7-5. 32 Main Input Upper Bits Option, Ribbon Cable Connections

Removal of DOS Option Assembly

The DOS assembly may be removed from the K105-D chassis to gain access to the card cage or other components. Use the following procedure to accomplish the removal.

1. Remove the four Phillips-Head screws securing the top cover to the DOS assembly, and carefully lift the top cover from the DOS housing.
2. Remove the two screws that secure the DOS base and ground connection lug to the top of the K105-D chassis.
3. Remove four screws (2 on each side) that secure the DOS assembly to the K105-D chassis.

NOTE: It is not necessary to disconnect the power harness and I/O ribbon cables from the drives during removal if the unit is to be reassembled.

4. Carefully lift the DOS assembly from the K105-D chassis and store the unit (with attached cables) to the left side of the K105-D chassis.
5. Position the DOS assembly on its side and ensure that the attached cables do not bind or otherwise interfere with internal components in the K105-D chassis.
6. Reinstall the DOS assembly by reversing the removal procedure. Ensure that the I/O signal cable is properly folded at a 45° angle at the I/O board connector (J1) so that it does not bind, nor interfere with other internal components, when the DOS assembly is positioned on top of the K105-D chassis.

INSTALLATION OF DOS OPTION

Unpacking and Inspection

All hardware items required to install and operate the Disk Operating System (DOS) option at the user's site are shipped in packaged units. External cables are included for connecting all components in the system. All items shipped for the system configuration are described in Table 7-5.

Table 7-5. DOS Option Components

PART NUMBER	DESCRIPTION
	DOS Option Assembly
0117-0164-10	I/O - Floppy Cable Assembly
0117-0170-10	DOS Power Harness Assembly
0117-0256-10	Storage Operating System Manual
0117-0261-10	K105-D Storage Operating System Disk
0117-0304-10	Instruction Sheet

All equipment was thoroughly inspected and checked out at the factory prior to packaging for shipment. After removing the equipment from its shipping container, inspect for scratches, dents or other damage that might have occurred during shipping. Refer to the shipping papers to verify that all items were received.

If equipment received from the carrier is incomplete or damaged, do not install the equipment. File a claim with the shipping firm immediately, and notify Gould Inc., Design and Test Systems Division Customer Service department at once. Gould Inc., Design and Test Systems Division will arrange for repair or replacement of the equipment without waiting for settlement of the claim against the carrier.

Installation

Prior to beginning the option installation, position the carrying handle of the K105-D to the front of the machine so that the unit rests flat on the work surface.

```

* * * * *
*           WARNING           *
*                               *
* Disconnect the 115 VAC source *
* to the K105-D prior to installing *
* any options; otherwise, a shock *
* hazard exists.              *
*                               *
* * * * *
    
```

Installation (cont'd.)

The following steps outline the procedure necessary to install the DOS option in the K105-D.

1. Remove the six Phillips-head screws securing the top cover to K105-D chassis, and carefully lift it from the unit.
2. Remove the four Phillips-head screws securing the top cover to the DOS assembly, and carefully remove the top cover from the unit. Note the orientation of the ribbon cable connectors and power harness connectors as they relate to the disk drives. Remove both sets of I/O cable connectors from the disk drives and remove the cables from the DOS assembly. (This will facilitate positioning and folding the I/O cable after the DOS unit is placed on the K105-D chassis.)
3. Referring to Figure 7-6, connect the single ribbon connector to the I/O board connector J1 nearest the front of the unit. The embossed arrow on the connector must be oriented toward the front of the machine.
4. Referring to Figure 7-7, connect the fully insulated power harness receptacles to the power supply terminal strip as illustrated. The user should note that the harness splits into two wire pairs; one pair consisting of a black wire and a red wire with a black stripe and the other pair consisting of a black wire and a brown wire. The black and red/black pair connect to power supply lugs nearest the rear of the unit.
5. Fold the I/O ribbon cable at a 45° angle so that it is dressed parallel to and on top of the I/O board and routed to the rear of the unit. Feed the two-connector end of the I/O ribbon cable and the two-connector end of the power harness through the oblong hole in the base of the DOS assembly. Ensure that no cables interfere with the positioning of the DOS assembly, and seat the assembly on top of the K105-D chassis.
6. Install the six retaining screws, 2 screws that secure DOS Base and ground lug to top of K105-D chassis and 4 screws that secure the sides of DOS unit to K105-D chassis.
7. Connect the ribbon cable connectors onto the disk drive board edge connectors with pin one of the ribbon cable connector oriented to the left of the drive as viewed from the front (refer to Figure 7-8). The cables should be dressed as shown in Figure 7-8.
8. Connect the power harness connectors to the drive connectors with the brown wires oriented to the left of the drives. See Figure 7-8.
9. Reinstall the DOS top cover with the four retaining screws.
10. Reconnect the 115 VAC source to the K105-D.

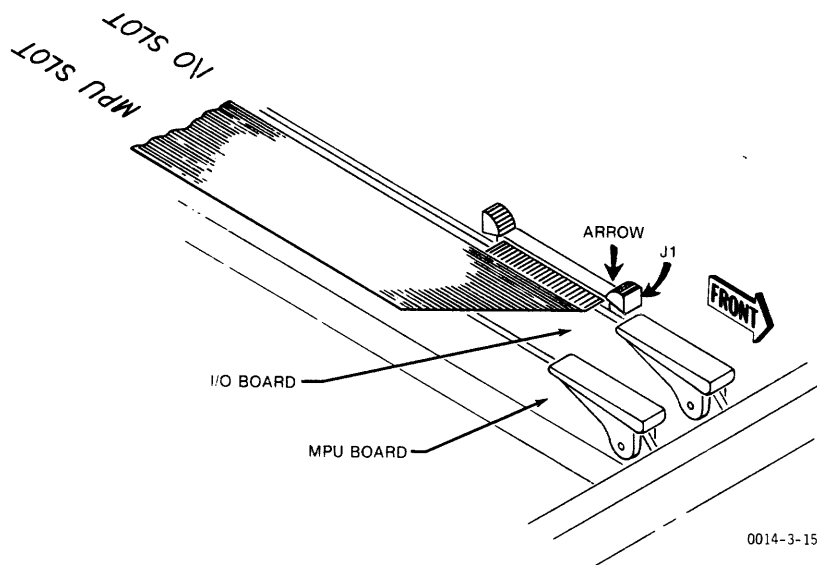

Figure 7-6. Disk Drive Ribbon Cable Connection to I/O Board

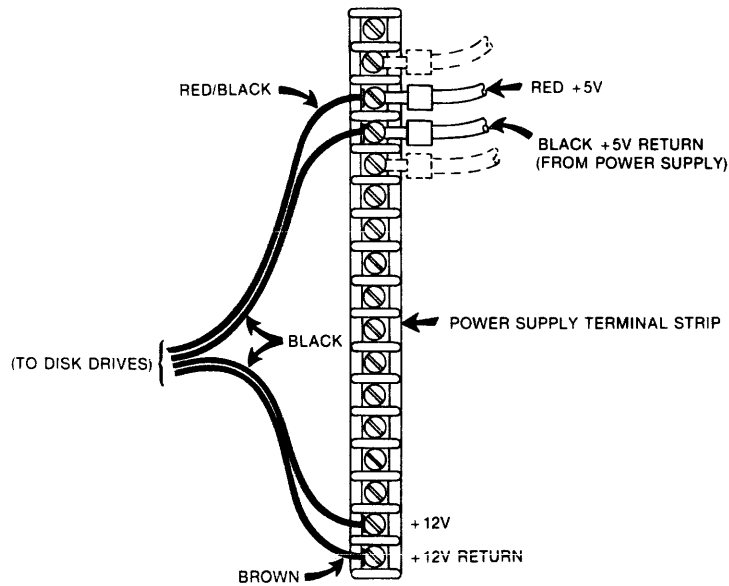

Figure 7-7. Disk Drive Power Harness Connections

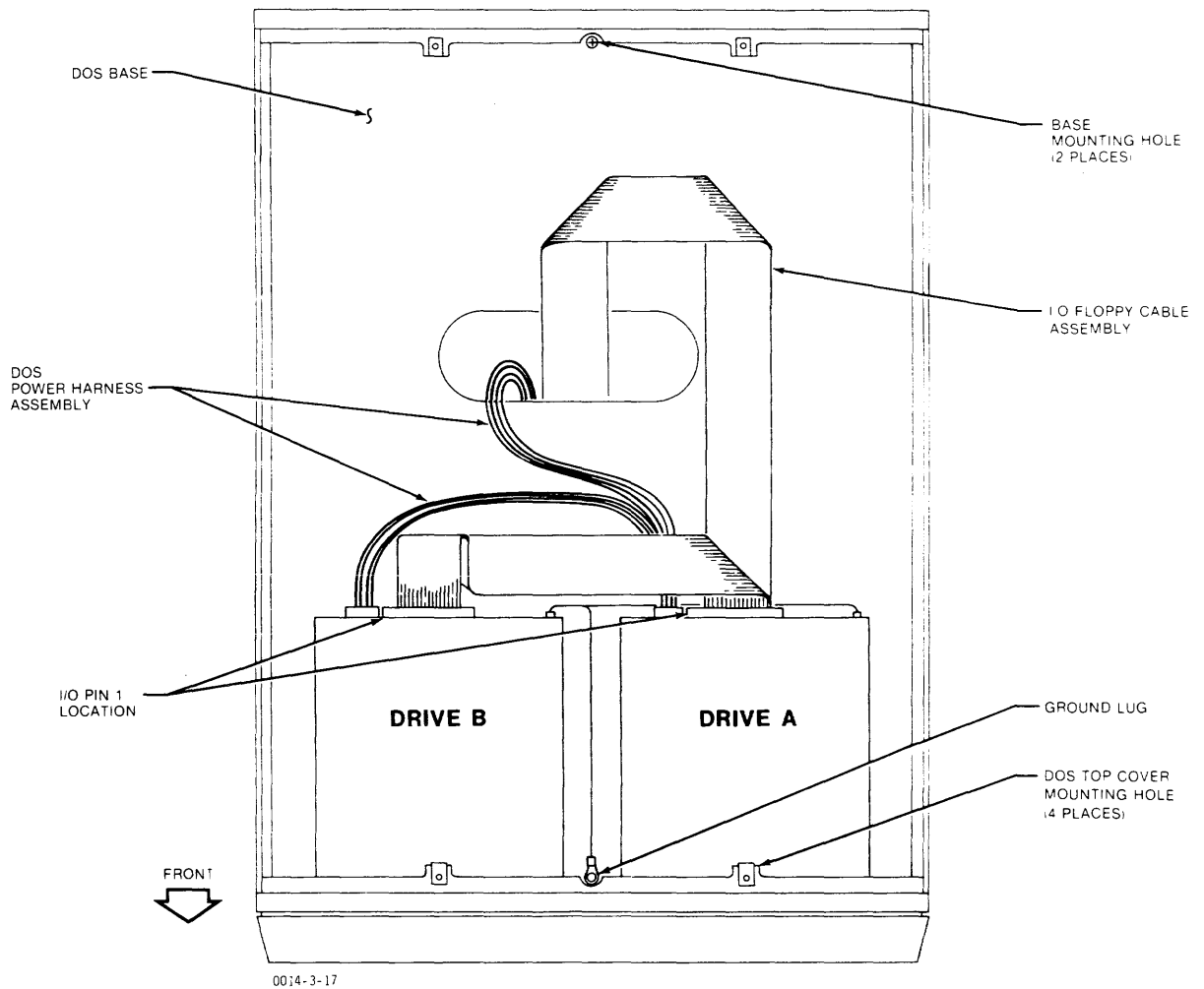

Figure 7-8. Top View of DOS Unit With Top Cover Removed

GLOSSARY OF TERMS

Acquisition Cycle

The cycle that a logic analyzer performs to acquire data consisting of the following steps:

1. Analyzer flushes all acquisition memory to 0 (zero).
2. Analyzer starts acquiring data.
3. End of record is reached.
4. Data is transferred from acquisition memory to system.
5. CRT display is updated with new data.

This cycle may be modified somewhat in auto-arm modes.

Active Field

The one data field on the CRT that is changed by pressing one of the data entry keys. The active field is identified by a blinking cursor.

Analog

In analog systems, information is encoded as a continuous range of signal values (voltage or current); in a digital system, information is encoded as signals that at any given time can only produce one of two states, 0 or 1.

Analog to Digital Conversion

The process of translating an analog signal into a sequence of binary digits that is representative of the analog signal level.

Arm Mode

The process of enabling the hardware to take a recording according to the following modes of operation as defined by the Arm Mode Set Up Screen when the ARM key is pressed.

1. Manual arm, in which one acquisition cycle is performed each time the ARM key is pressed.
2. Auto arm, in which the analyzer continuously rearms until the STOP key is pressed.
3. Auto arm with condition (also known as autostop), in which the analyzer rearms until some condition occurs.

GLOSSARY OF TERMS (Cont'd.)

Clock Transition

The change of state of a clock line. For each clock pulse, two transitions occur: the rising and falling edges of the pulse. In most cases, data is transferred only on one of these edges.

Data Domain Analysis

The use of the logic analyzer to view digital data decoded as symbolic values. Normally, the data is displayed as binary, octal or hexadecimal, although ASCII and EBCDIC representations can also be viewed.

Data Pattern Definitions

In the K105-D Logic Analyzer, the trace control system can be programmed to act on the appearance of a given pattern in the data stream. Part of the Trace Control screen is used for entering certain pattern values and assigning them symbolic names.

Data Transition

The change of state of a data line.

Delay Counter

A 16-bit counter on the trace control board that is loaded with a preprogrammed value whenever a trace control level is entered or re-entered. On each level, the counter can be programmed to decrement either on each clock or on occurrences of the advance pattern. Whenever a new level is entered, the hardware is in the state $COUNT < DELAY$. When the counter reaches zero, the hardware is in the state $COUNT = DELAY$. Thereafter, the state is $COUNT > DELAY$.

Demultiplex

Several microprocessors use a multiplexed bus, in which data, address and status information are sent over the same set of lines at different times. To simplify use of the logic analyzer with these processors, a demultiplex mode is provided, in which data from one set of probe inputs is routed to two different inputs internally, each of which can be clocked separately.

Event

In a logic analyzer, an "event" is a series of one or more sequential samples in which a particular condition is true, surrounded by samples in which that condition is not true.

GLOSSARY OF TERMS (Cont'd.)

Field

A field is a part of a display that shows one particular type of information. Usually the term refers to display items that can be altered by the operator.

Logic Analyzer

A logic analyzer is a device that records digital signals and displays the recorded data.

Loop Counter

A counter on the trace control board that can be used to keep track of the number of times that a given trace control level is entered. Note that this counter differs from the delay counter, which counts the number of occurrences of a given condition within one level.

Master Clock

The clock that moves data into the trace control board and on into the acquisition memory.

Occurrence

One "event" is an appearance of a given condition, for however long the condition remains true. One "occurrence" is the presence of a condition on any sample, regardless of whether it was also true on the previous sample. For example, if a condition is true for three samples in a row, this is considered three "occurrences" of that condition, but only one "event".

Pass Counter

A counter that keeps track of the number of arm cycles that have occurred since the ARM key was pressed.

Quick-Key

When setting up the K-105, most fields have a fixed number of legal choices. These fields are normally set using the NEXT or PREV keys, but can also be set by entering the hex digit associated with the desired choice. A hex digit key used in this manner is referred to as a "quick-key".

GLOSSARY OF TERMS (Cont'd.)

Radix/Radices

The radix of a number system is equal to the number of possible symbols for each digit. The binary number system has a radix of 2, since each digit is one of two possible symbols: 0 and 1. Octal has a radix of 8; hexadecimal has a radix of 16. In the K-105 logic analyzer, the term is used loosely to mean symbolic representation system, where the choices are: Binary (1 bit), Quad (2 bits), Octal (3 bits), Hex (4 bits), X (5 bits), ASCII-6 (6 bits) and ASCII-7 (7 bits).

Recording

A recording is the data traced during an acquisition cycle and retained when the acquisition cycle ends. If the logic analyzer traces more samples than its memory can store, only the most recent data is retained.

Threshold

A voltage limit above or below which a signal is recognized as a defined value, usually the binary digit of 1 or 0.

Threshold Range

A voltage range over which successive threshold measurements are made.

Time Domain Analysis

Time domain analysis displays the recorded data as idealized oscilloscope traces. This analysis is useful for viewing timing relationships among the signal lines.

Tolerance Comparison

The K-105 can compare the data stored in memory A with that stored in memory B. To enhance flexibility, the K-105 allows "Don't Care" samples to be stored in memory B. These samples are simply not compared with their counterparts in memory A. This condition allows tolerances to be placed around rising and falling edges in memory B. The comparison control screen (accessed with Shift-Compare), provides a means for generating tolerances around each edge in the memory B buffer.

GLOSSARY OF TERMS (Cont'd.)

Trace Control

Trace Control is a trademarked feature of Gould logic analyzers. It is a system for selectively storing events of interest while ignoring all other system activity.

Trace Command Sequence

In the K-105 logic analyzer, trace control is setup through a series of simple commands. These form a sequence of commands that are performed on each acquisition cycle, subject to conditional commands present in the sequence.

Trace Level

The K-105 trace control system has eight basic states, called levels, each of which has certain options and conditions. When each sample is traced, the trace level is stored along with the data. These levels can be viewed in the Data screen.

This appendix is a tutorial for trace control. Individual examples are provided for sequences in capturing specific trace events.

Example 1

FILL MEMORY WITH SAMPLES FROM ANYWHERE IN DATA STREAM

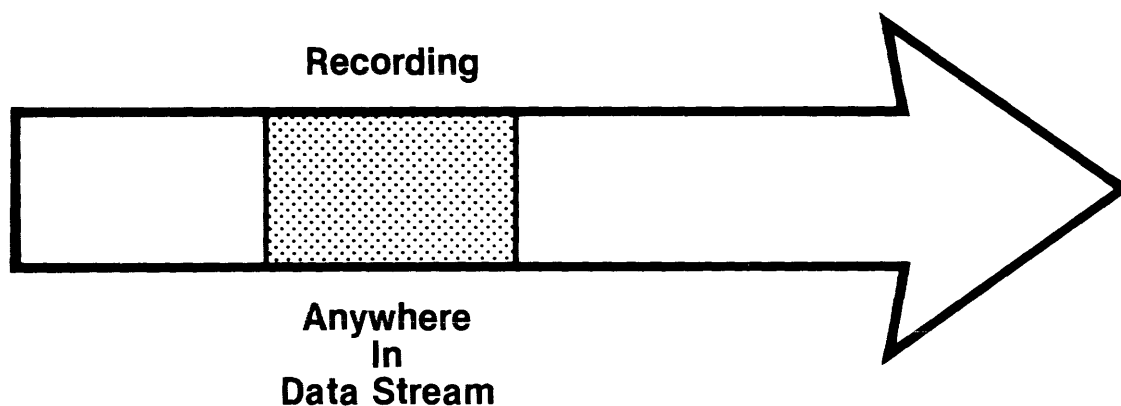

Purpose: To capture any sequential data sample window.

Benefit: Is the simplest method of checking if the system under test is operational, if the logic analyzer is set up properly, and to see what is happening in the system under test.

Procedure: Samples begin tracing into memory upon the ARM command and stop tracing when the memory is full.

```

SET UP MAIN TRACE
LVL COMMAND SEQUENCE:
0:TRACE FOR 01024 CLOCKS

```

COMMENTS

Stop inferred on Level 1.

Example 2

FILLING MEMORY AFTER A WORD

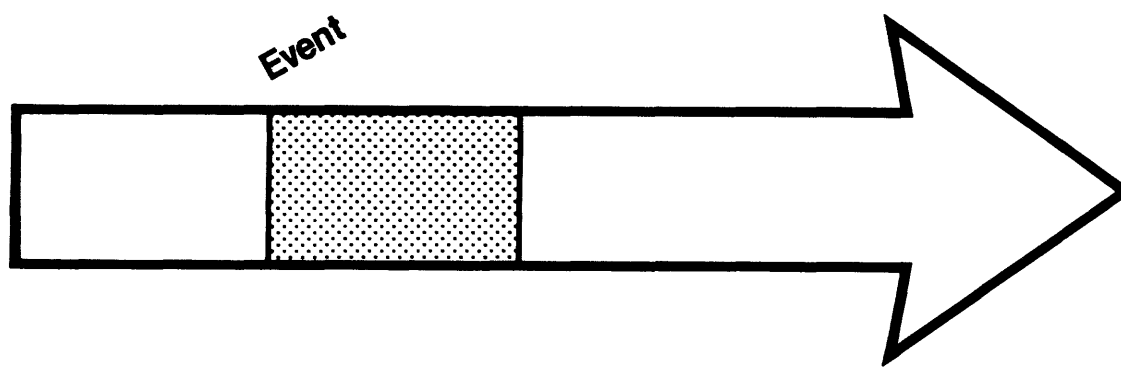

Procedure: Upon the occurrence of a specified event, begin tracing and stop when memory is full. (The specified event will be in the first memory location.)

```
                SET UP MAIN TRACE
LVL   COMMAND SEQUENCE:
0: TRACE IF .... SAMPLE = EVENT
      ADVANCE IF SAMPLE = EVENT
1: TRACE FOR 01023 CLOCKS
```

COMMENTS

- 0: Wait for event, trace the event and advance to the next level.
- 1: Trace until the rest of the memory is full.
- 2: inferred Stop.

Example 3

RECORD WHAT HAPPENS IMMEDIATELY BEFORE AN EVENT

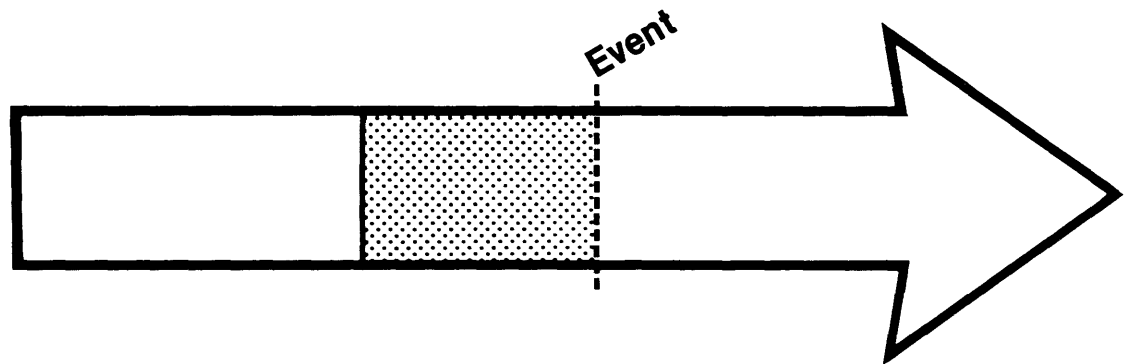

Procedure: Trace everything until a specific event occurs.
Stop tracing immediately.
(The event will be in the last memory location.)

```
SET UP MAIN TRACE
LVL  COMMAND SEQUENCE:
0: TRACE UNTIL SAMPLE = EVENT
```

COMMENTS

Stop immediately when
EVENT occurs.

Record everything.

Note: The event of interest could occur before 1024 samples have occurred, thereby having some samples still in memory which are unrelated to the current recording. The following will “fill” the memory with new samples before advancing to look for the event.

```
SET UP MAIN TRACE
LVL  COMMAND SEQUENCE:
0: TRACE FOR 01024 CLOCKS
1: TRACE UNTIL SAMPLE = EVENT
```

COMMENTS

Advance after a memory full of
(1024) of sample clocks has
occurred. Trace everything.

Example 3A

RECORD WHAT HAPPENS IMMEDIATELY BEFORE AN EVENT

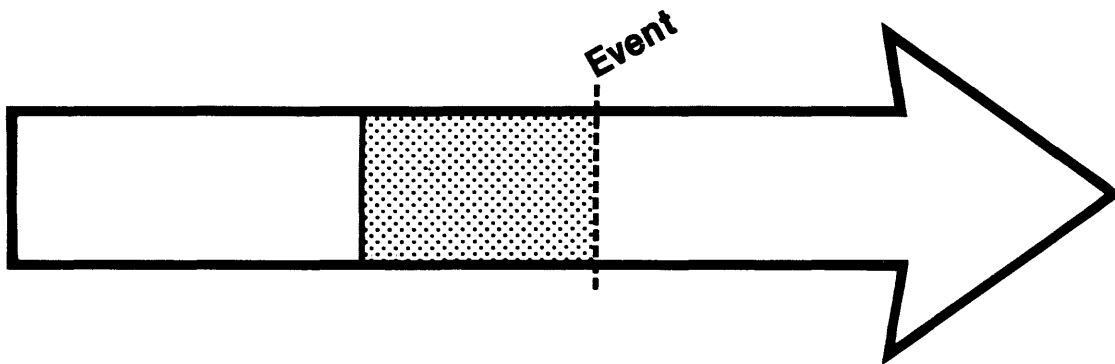

Procedure: Trace everything until a specific event occurs.
Stop tracing immediately.
(The event will be in the last memory location.)

SET UP MAIN TRACE
LVL COMMAND SEQUENCE:
0: TRACE UNTIL SAMPLE = EVENT

COMMENTS

Stop immediately when
EVENT occurs.

Record everything.

Example 3B

RECORD WHAT HAPPENS IMMEDIATELY BEFORE AN EVENT

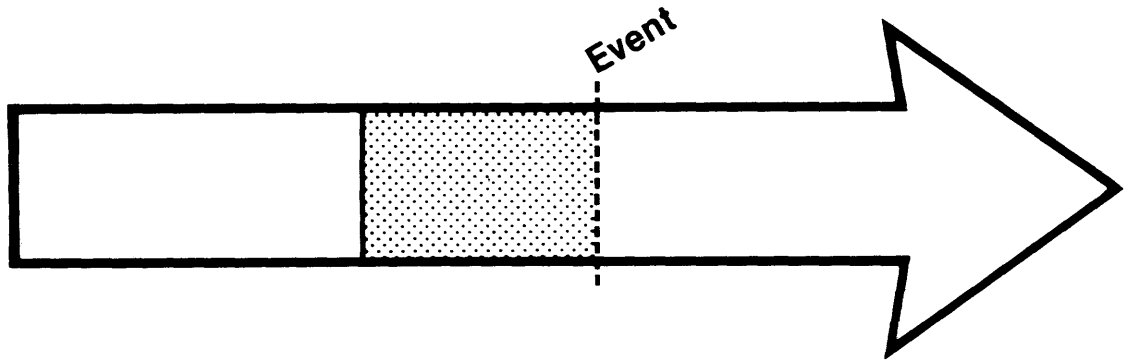

Note: The event of interest could occur before 1024 samples have occurred, thereby having some samples still in memory which are unrelated to the current recording. The following will “fill” the memory with new samples before advancing to look for the event.

```
SET UP MAIN TRACE
LVL  COMMAND SEQUENCE:
0: TRACE FOR 01024 CLOCKS
1: TRACE UNTIL SAMPLE = EVENT
```

COMMENTS

Advance after a memory full of (1024) of sample clocks has occurred. Trace everything.

Example 4

RECORD WHAT HAPPENS AROUND AN EVENT

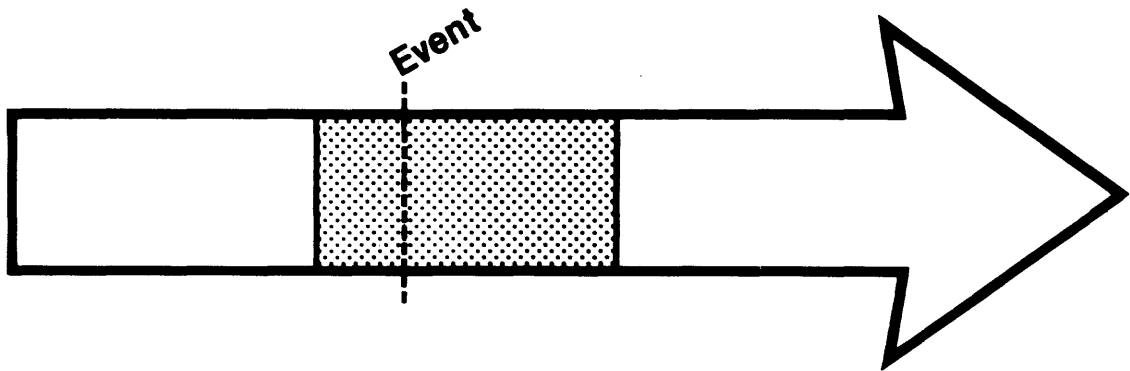

Benefit: By moving the window, different portions of the data stream can be quickly examined.

Procedure: Trace everything while waiting for an event to occur. When it occurs, count out the delay needed to position it where you want it in memory.

```
SET UP MAIN TRACE  
  
LVL   COMMAND SEQUENCE:  
0: SET DELAY TO 00512 CLOCKS  
   TRACE UNTIL SAMPLE = EVENT  
      AND COUNT ≥ 00512  
1: TRACE FOR 00512 CLOCKS  
2: STOP
```

COMMENTS

For this example the event will be centered in memory.

0: Fills the first half of memory with samples. After that the event is looked for. When the event occurs, the machine advances.

1: The rest of the memory is filled before stopping.

Note the two delays (both 512 here) must equal 1024 to fill memory. Use different ratios (i.e., 400:612) to alter the position of the event in memory.

Example 5

RECORD WHAT HAPPENS LONG AFTER AN EVENT

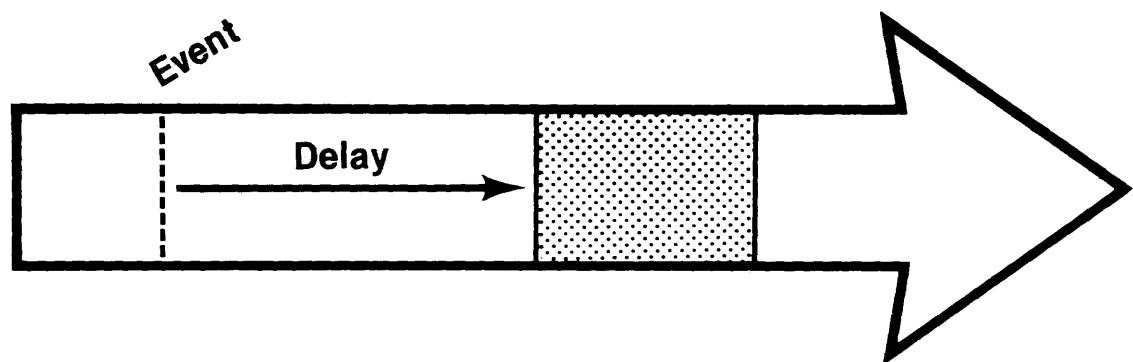

Benefit: Examining portions of the data stream occurring a long time after the initial event is possible. When the storage subsystem is used, many 1K byte windows may be stored, to create a wide angle picture of data streams that are megabytes long. This is useful for design verification.

Procedure: After an event occurs, delay the start of recording until a set period of time has passed. Record a segment and stop. (The event need not appear anywhere in memory.)

```

SET UP  MAIN TRACE
LVL     COMMAND SEQUENCE:
0: WAIT UNTIL SAMPLE = EVENT
1: WAIT   FOR   10000 CLOCKS
2: TRACE  FOR   01024 CLOCKS

```

COMMENTS

- 0: The event is found causing the machine to advance.
- 1: A delay is waited out (in this case 10000 clocks).
- 2: A recording is made for 1024 clocks.

Example 6

ONE WINDOW

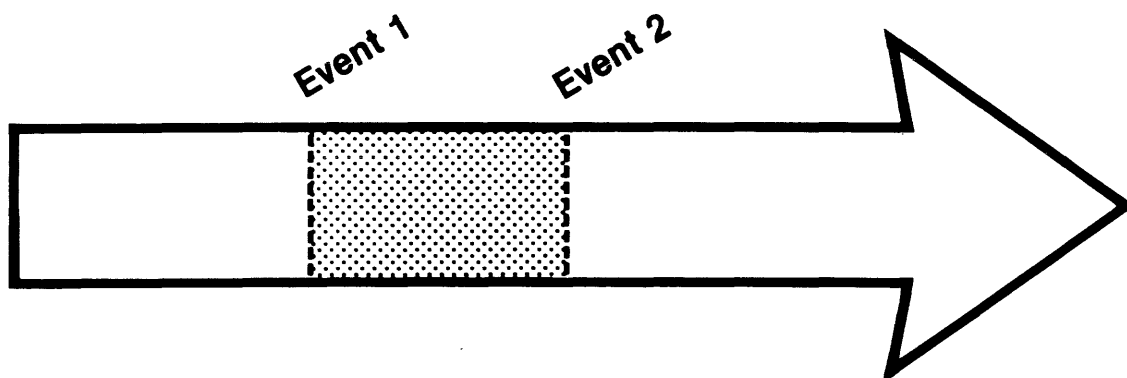

Purpose: To record samples only between (and including) two specified events.

Benefit: By using this capability in conjunction with disabling autoflush, or with the loop counter (STOP ON LEVEL ENTRY), several windows may be stored serially for verification of repeatability.

Procedure: Look for the first event, record it and everything following until the second event occurs, and then stop tracing.

```
SET UP MAIN TRACE
LVL COMMAND SEQUENCE:
0: TRACE IF ... SAMPLE = EVENT 1
  ADVANCE IF SAMPLE = EVENT 1
1: TRACE UNTIL SAMPLE = EVENT 2
```

COMMENTS

1: The recording will stop on this level unless level 2: is specified. STOP is inferred.

Example 7

TWO WINDOWS

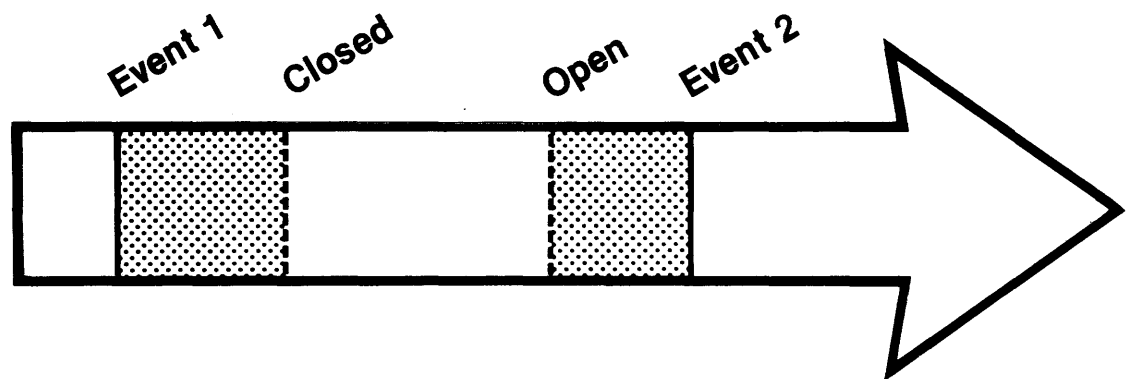

Purpose: To not record samples between two specific events.

Benefit: Captures cause and effect relationships in code execution, although they may be separated by megabytes.

Procedure: Trace during two windows defined by EVENT 1 and CLOSED (1st window) and OPEN and EVENT 2 (2nd window).

```
SET UP MAIN TRACE
```

```
LVL COMMAND SEQUENCE:
```

```
0: TRACE IF ... SAMPLE = EVENT 1
  ADVANCE IF SAMPLE = EVENT 1
1: TRACE UNTIL SAMPLE = CLOSED
2: TRACE IF ... SAMPLE = OPEN
  ADVANCE IF SAMPLE = OPEN
3: TRACE UNTIL SAMPLE = EVENT 2
```

COMMENTS

- 0: Only EVENT 1 is traced.
- 1: All samples are traced after EVENT 1 up to and including CLOSED.
- 2: Only OPEN is traced.
- 3: All samples are traced after OPEN up to and including EVENT 2.

Example 8

NESTED TRIGGERING

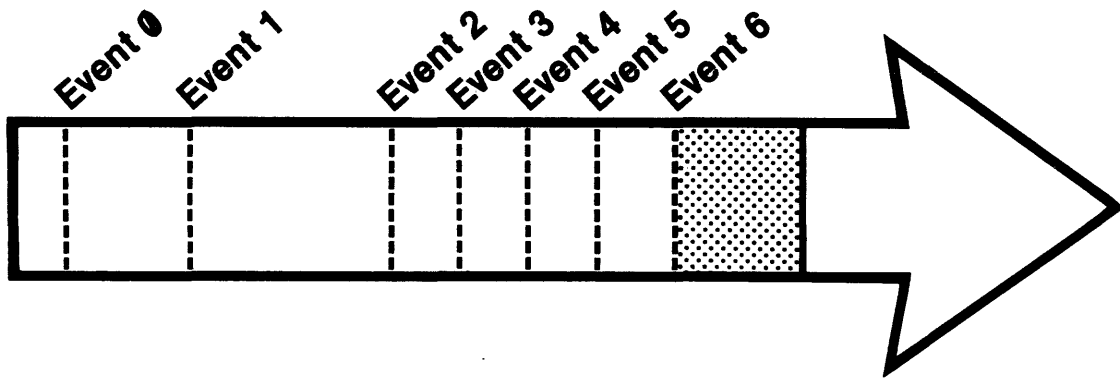

Purpose: A certain series of events must occur before a recording is made.

Benefit: Very precisely defines an area of interest to record, provides a way to get inside a multi-nested sub-routine or to follow a complex program path.

Procedure: Check for EVENT 0 to occur, then check for EVENT 1 to occur, etc., finally check for EVENT 6 to occur and record around it as desired.
(Record immediately after is shown in the following example.)

```

SET UP MAIN TRACE

LVL COMMAND SEQUENCE:
0: WAIT UNTIL SAMPLE = EVENT 0
1: WAIT UNTIL SAMPLE = EVENT 1
2: WAIT UNTIL SAMPLE = EVENT 2
3: WAIT UNTIL SAMPLE = EVENT 3
4: WAIT UNTIL SAMPLE = EVENT 4
5: WAIT UNTIL SAMPLE = EVENT 5
6: TRACE IF ... SAMPLE = EVENT 6
   ADVANCE IF SAMPLE = EVENT 6
7: TRACE FOR 01023 CLOCKS
  
```

COMMENTS

As shown, EVENT 6 will be the first sample in memory. To capture pre-event 6 samples start tracing on earlier levels and reduce the delay (1024) on level 7.

Example 9A

14 LEVELS OF SEQUENTIAL TRIGGERING

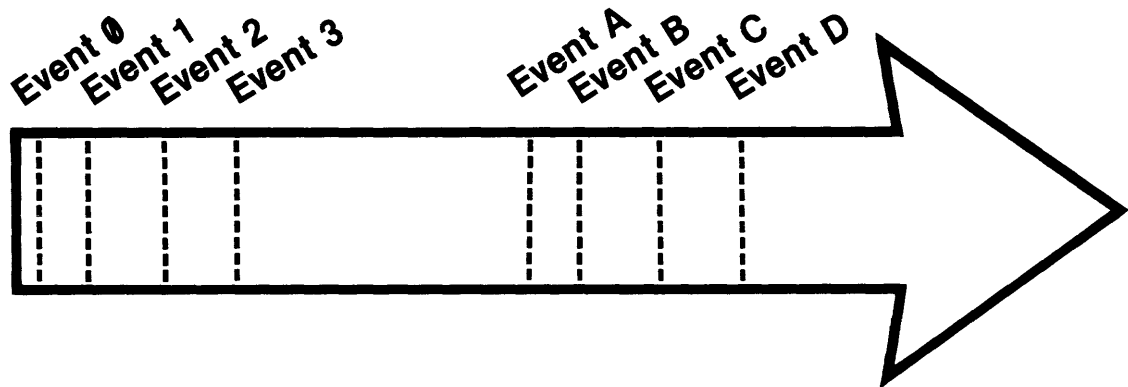

Purpose: A certain series of events must occur before a recording is made.

Benefit: Very precisely defines an area of interest to record, provides a way to get inside a multi-nested sub-routine or to follow a complex program path, up to 13 events may be defined before the final event.

Procedure: Check for EVENT 0 to occur, then check for EVENT 1 to occur, etc., finally check for EVENT D to occur and record around it as desired.
(Record immediately after is shown in the following example.)

Example 9B

14 LEVELS OF SEQUENTIAL TRIGGERING

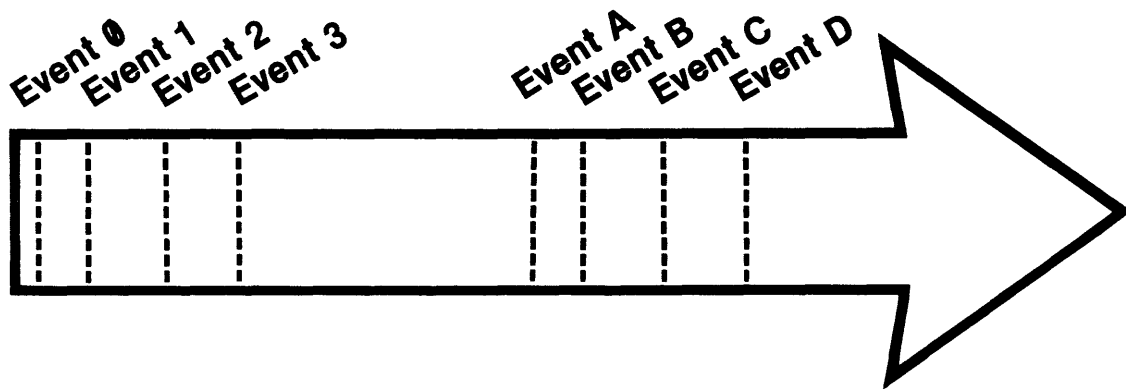

COMMENTS

```

                SET UP MAIN TRACE
LVL  COMMAND SEQUENCE:
0: TRACE UNTIL SAMPLE = EVENT 0
   OR UNTIL   SAMPLE = EVENT 7
1: TRACE UNTIL SAMPLE = EVENT 1
   OR UNTIL   SAMPLE = EVENT 8
2: TRACE UNTIL SAMPLE = EVENT 2
   OR UNTIL   SAMPLE = EVENT 9
3: TRACE UNTIL SAMPLE = EVENT 3
   OR UNTIL   SAMPLE = EVENT A
4: TRACE UNTIL SAMPLE = EVENT 4
   OR UNTIL   SAMPLE = EVENT B
5: TRACE UNTIL SAMPLE = EVENT 5
   OR UNTIL   SAMPLE = EVENT C
6: TRACE UNTIL SAMPLE = EVENT 6
   OR GO TO 0 IF SAMPLE = EVENT 6
7: TRACE FOR 02512 CLOCKS
```

Two paths are established; Levels 0 to 5 look for EVENT 0 to 5 respectively and advance on them. Until level 6 when EVENT 6 causes a jump to level 0.

The second path starts on level 0. Events 7 to D cause advance from levels 0 to 6 respectively, advancing into level 7 after EVENT D.

On level 7 the recording stops, after 512 more clocks. Vary the delay value in level 7 to change the position of EVENT D in memory.

Example 10

CHECK FOR EVENT 1 OR EVENT 2. TAKE A DIFFERENT PATH DEPENDING ON WHICH EVENT OCCURRED FIRST.

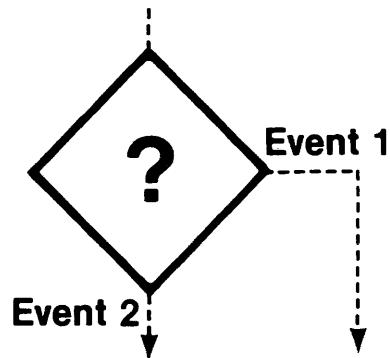

- Purpose:** Monitor a particular point in the program flow for the occurrence of one of two possible events.
- Benefit:** Gives the ability to follow program branches, take alternative paths, and make decision in real time. Trace Controls architecture is like program flow and can easily handle branching.
- Procedure:** Simultaneously check for 2 events. If EVENT 1 occurs, follow trace routine 1. If EVENT 2 occurs, follow trace routine 2.

```

SET UP  MAIN TRACE
LVL COMMAND SEQUENCE:
0: WAIT  ---
  ADVANCE IF SAMPLE = EVENT 1
OR GO TO 6 IF SAMPLE = EVENT 2

```

COMMENTS

If EVENT 1 occurs first, the trace control advances to level 1, if event 2 occurs first, the trace control jumps to level 6. Other building blocks should be used on levels 1 and 6.

Example 11

SELECTIVELY RECORD ONLY ONE KIND OF EXAMPLE

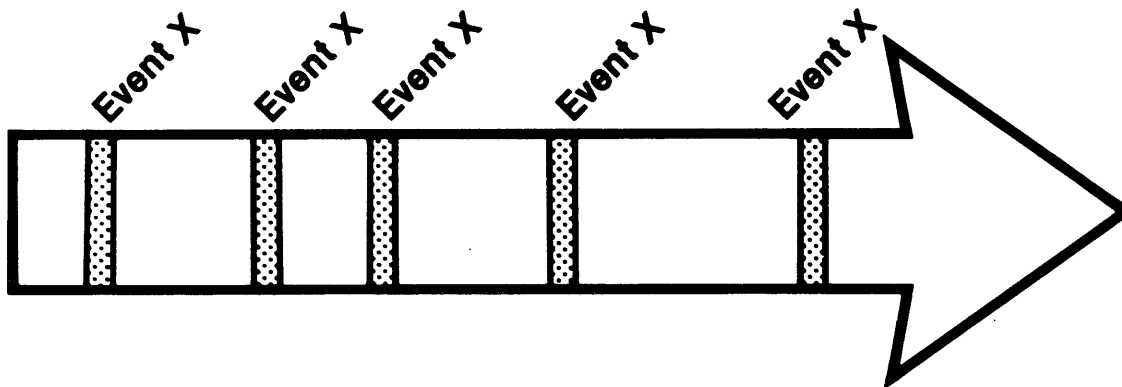

Purpose: To record only one specific type of sampled event.

Benefit: When "effects" do not occur reliably, this method will allow the examination of many effects in code execution.

Procedure: Look for and trace each and every occurrence of a specific event, trace only that event.

```
SET UP MAIN TRACE
LVL COMMAND SEQUENCE:
0: SET DELAY TO 01024 COUNTS OF SAMPLE = EVENT X
TRACE IF ...: SAMPLE = EVENT X ---
ADVANCE IF SAMPLE = EVENT X AND COUNT = 01024
1: STOP
```

COMMENTS

Only the last 1024 occurrences of EVENT X are captured. To capture the last of a longer string of EVENT X increase the delay value (i.e., a delay of 10,000 capture the last 1024 of 10,000 occurrences of EVENT X).

Example 12 TO CAPTURE A DEFINED NUMBER OF ITERATIONS OF A LOOP

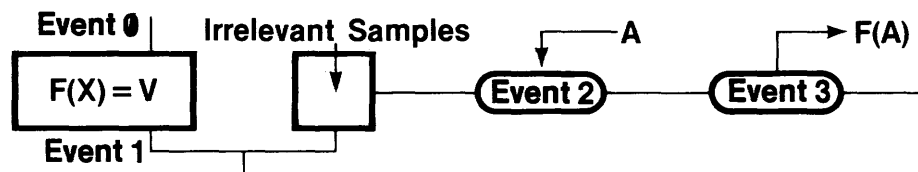

Purpose: Verify that a cause is having predicted effects for many samples of the effects.

Benefit: Hundreds of windows can be captured in a single recording, while irrelevant samples are ignored. For example: If the characteristic transfer function of an ADC is defined during an autocalibration to be some $F(X) = V$, it may be captured. Then capture of a value "A" can be made and then $F(A)$ where "A" is plugged into $F(X)$. The next iteration of the loop will allow capture "B" and $F(B)$ and so on (for 420 values and plug-ins). The repeatability with which the $F(X) = V$ function is followed can be tested.

Procedure: Capture from EVENT 0 to EVENT 1, then capture 420 executions of "LOOP."

```

SET UP MAIN TRACE
LVL COMMAND SEQUENCE:
0: TRACE IF ...SAMPLE = EVENT 0
  ADVANCE IF SAMPLE = EVENT 0
1: TRACE UNTIL SAMPLE = EVENT 1
2: TRACE IF ...SAMPLE = EVENT 2
  ADVANCE IF SAMPLE = EVENT 2
3: TRACE IF ...SAMPLE = EVENT 3
  ADVANCE IF SAMPLE = EVENT 3
4: STOP UPON ENTERING LEVEL
  420 TIMES GO TO 2
  
```

COMMENTS

- 0 and 1: Capture from EVENT 0 to EVENT 1.
- 2 and 3: Capture the value and plug-in respectively.
- 4: Goes back to 2 until it has been entered after the 420th insertion of the loop.

Example 13A

CONTINUOUS MONITORING FOR CORRECT OPERATION

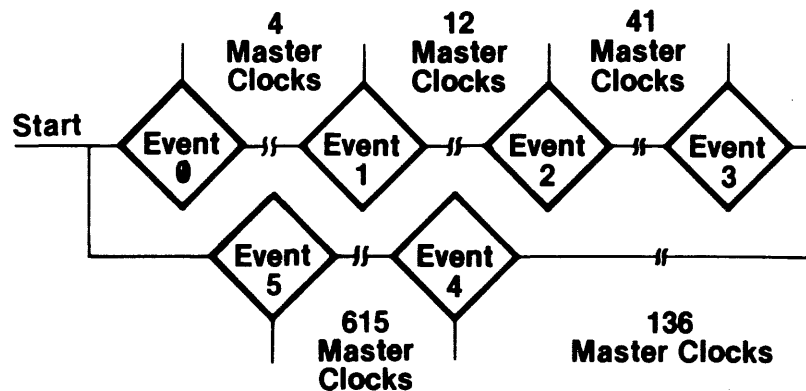

Purpose: To monitor a particular point in a program through repeated executions of the program.

Benefit: Exercises hardware and software through repeated testing. Traps intermittent errors.

Procedure: Check for an expected series of events to occur. If they do, run the program and trace test again. If an error ever occurs, stop tracing and look at what happened.

Example 13B

CONTINUOUS MONITORING FOR CORRECT OPERATION

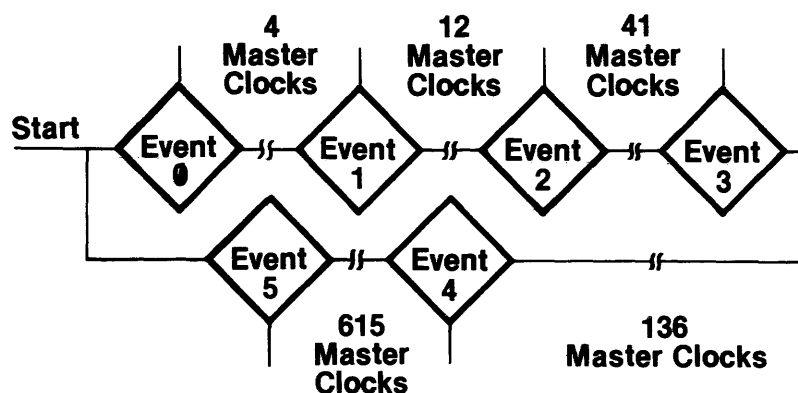

```

SET UP MAIN TRACE
LVL  COMMAND SEQUENCE:
0: TRACE UNTIL SAMPLE = EVENT 0
1: SET DELAY TO 00004 CLOCKS
   TRACE UNTIL SAMPLE = EVENT 1 AND COUNT = 00004
   OR GO TO 6 IF SAMPLE ≠ EVENT 1 AND COUNT = 00004
2: SET DELAY TO 00012 CLOCKS
   TRACE UNTIL SAMPLE = EVENT 2 AND COUNT = 00012
   OR GO TO 6 IF SAMPLE ≠ EVENT 2 AND COUNT = 00012
3: SET DELAY TO 00041 CLOCKS
   TRACE UNTIL SAMPLE = EVENT 3 AND COUNT = 00041
   OR GO TO 6 IF SAMPLE ≠ EVENT 3 AND COUNT = 00041
4: SET DELAY TO 00136 CLOCKS
   TRACE UNTIL SAMPLE = EVENT 4 AND COUNT = 00136
   OR GO TO 6 IF SAMPLE ≠ EVENT 4 AND COUNT = 00136
5: SET DELAY TO 00615 CLOCKS
   TRACE UNTIL SAMPLE ≠ EVENT 5 AND COUNT = 00615
   OR GO TO 0 IF SAMPLE = EVENT 5 AND COUNT = 00615
6: SET DELAY TO 00216 CLOCKS
   TRACE UNTIL COUNT = 00216

```

COMMENTS

The trace control looks for EVENT 0, then exactly 4 master clocks later EVENT 2, then 41 master clocks later EVENT 3, then 136 master clocks later EVENT 4, then 615 master clocks later EVENT 5.

If all of the above occurs exactly as expected, then the trace control resets and starts to wait for EVENT 0. Should the program path change and the expected not happen exactly as expected, the trace control jumps to level 6 where it stops after waiting 216 clocks.

Example 14

TRIGGER FILTERING

Purpose: To act when an event has been present for a predetermined number of clocks.

Benefit: When making an asynchronous recording, triggering on noise or glitches is undesirable. Triggering on stable inputs assures examination of the same section of code for each recording.

Procedure: EVENT 0 must be present for 9 master clock cycles to advance.

```
SET UP MAIN TRACE

LVL  COMMAND SEQUENCE:
0: GO TO 1
1: SET DELAY TO 00009 COUNTS OF SAMPLE = EVENT 0
   WAIT UNTIL SAMPLE = EVENT 0 AND COUNT > 00009
   OR GO TO 0 IF SAMPLE ≠ EVENT 0 ---
```

COMMENTS

This set-up will loop until 9 consecutive occurrences of EVENT 0 cause an advance to level 2.

Example 15A

CHECK FOR EXPECTED TIME PERIOD BETWEEN TWO EVENTS

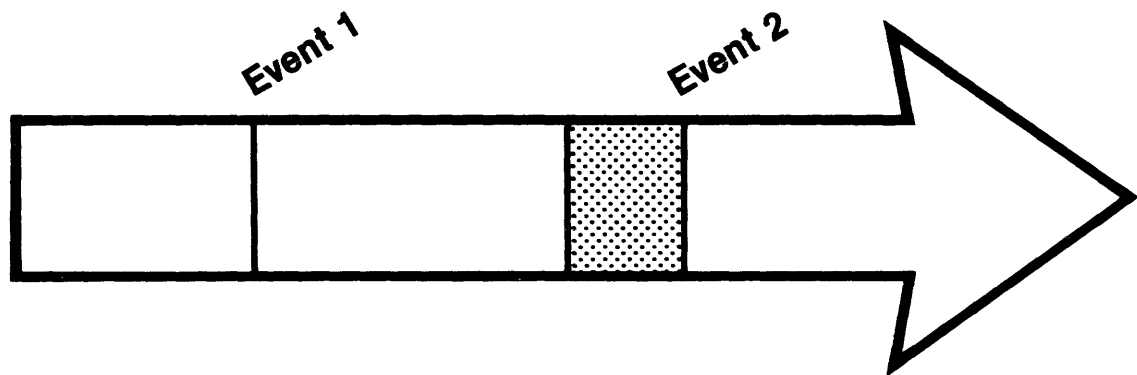

- Purpose:** To monitor the occurrence of two events and capture when the second event happens prematurely or too late relative to the first event.
- Benefit:** Develops confidence that the section of code (between EVENTS 1 and 2) is running in a predictable way, or presents evidence that it is not running as predicted.
- Procedure:** Find EVENT 1, look for EVENT 2. If EVENT 2 happens too early or too late then stop.

Example 15B

CHECK FOR EXPECTED TIME PERIOD BETWEEN TWO EVENTS

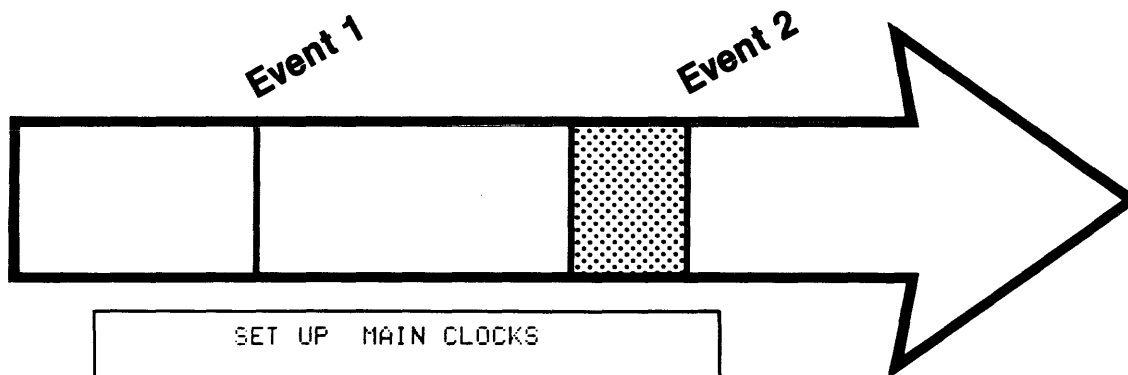

```

SET UP MAIN CLOCKS

CLOCK SOURCE      = INTERNAL
MASTER CLOCK     = 1 MICROSECONDS

SET UP MAIN TRACE

LVL  COMMAND SEQUENCE:
0: TRACE UNTIL SAMPLE = EVENT 1
1: SET DELAY TO 00400 CLOCKS
   TRACE UNTIL COUNT = 00400
   OR GO TO 3 IF SAMPLE = EVENT 2 AND COUNT < 00400
2: SET DELAY TO 00100 CLOCKS
   TRACE UNTIL COUNT = 00100
   OR GO TO 0 IF SAMPLE = EVENT 2 AND COUNT ≤ 00100
3: STOP

```

COMMENTS

- 0: Find EVENT 1 then advance to level 1.
- 1: If EVENT 2 occurs within 400 μ seconds, then stop by jumping to level 3, if 400 μ seconds elapse and EVENT 2 has not been detected (as it should not), then advance to level 2.
- 2: If EVENT 2 occurs within 100 μ seconds (as it should), then reset to level 0, because this iteration acted as predicted. If EVENT 2 does not happen during the 100 μ seconds, then stop by advancing to level 3.

The trace control will examine each and every iteration until EVENT 2 does not appear within the 100 μ second window as it should.

Example 16

4-DIGIT HEX COUNTER

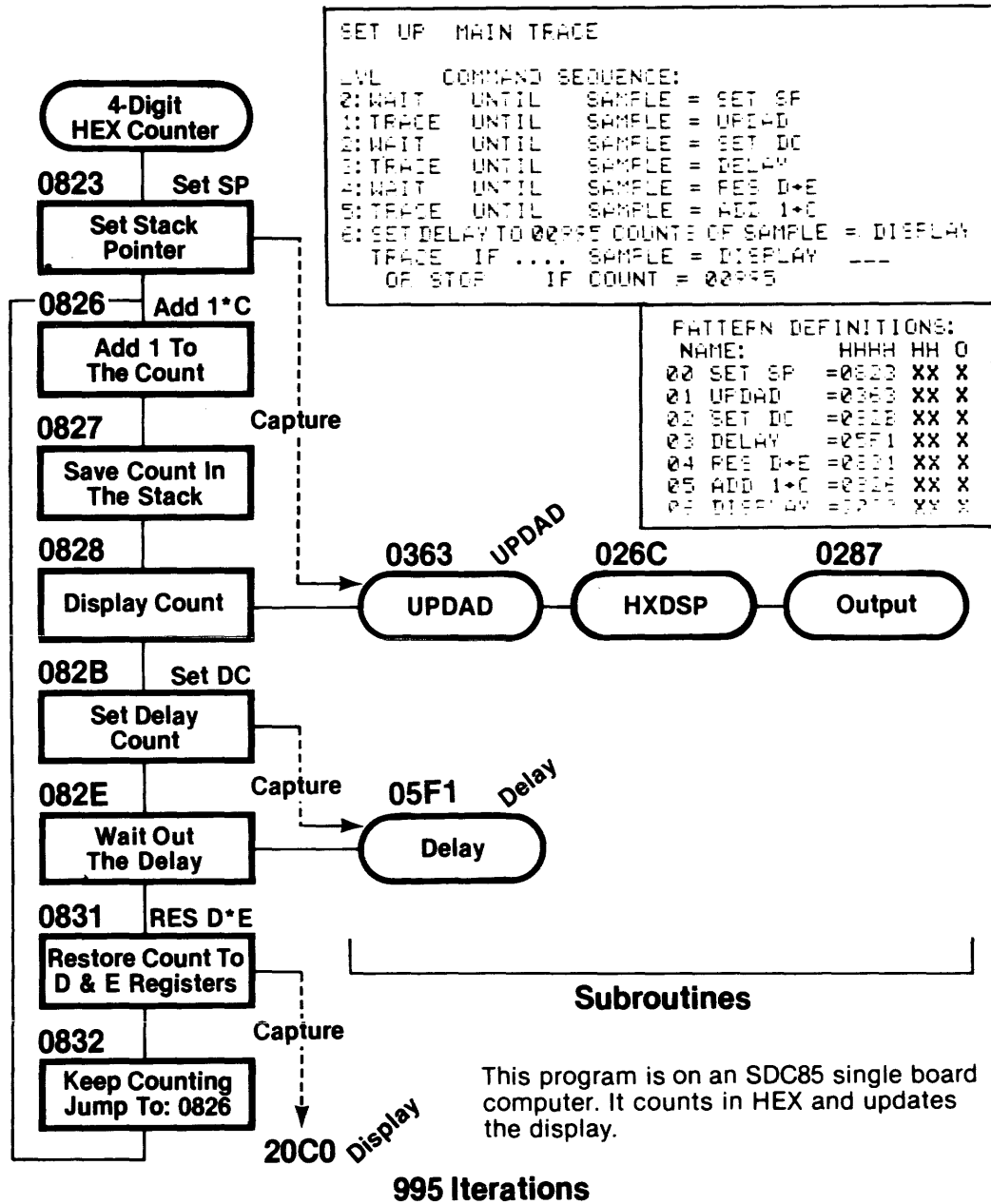

Example 17A

LINKING HIGH-SPEED AND MAIN TRACE (PART 1)

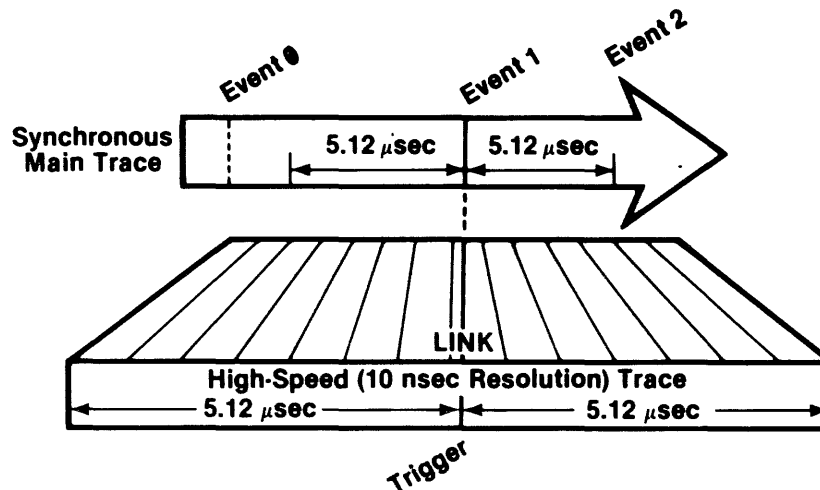

Purpose: Let an EVENT on the MAIN inputs cause a recording on the HIGH-SPEED section.

Benefit: Examining timing relationship during critical periods in programming execution, to find the causes of misexecution. Particularly valuable in the hardware/software integration process.

Procedure: Three events appear in sequence, EVENTS 0, 1 and 2 respectively. Capture all samples until EVENT 2 and make a high speed recording centered about the time EVENT 1 occurs.

Example 17B

LINKING HIGH-SPEED AND MAIN TRACE (PART 1)

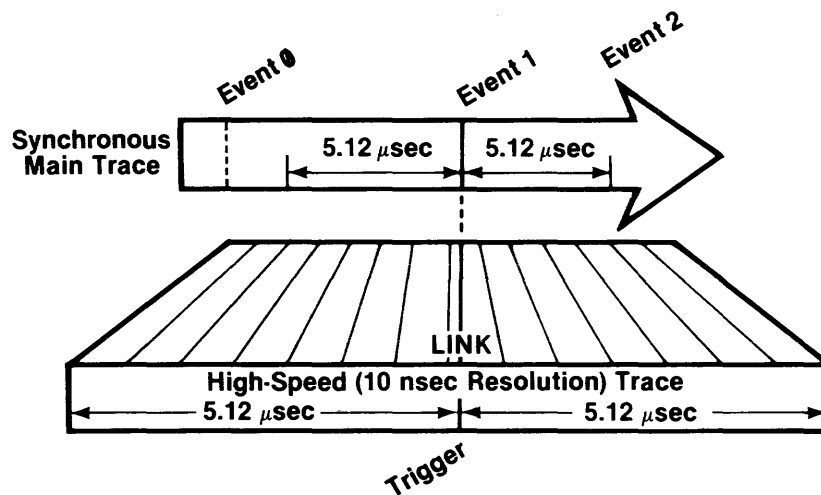

```

SET UP HIGH SPEED LINKED

RADIX:  B B B B B B B B
SEQUENCE:  7 6 5 4 3 2 1 0 01
TRIGGER:  IF      
          BECOMES TRUE & REMAINS TRUE FOR 01 SAMPLES
          THEN STOP AFTER 00512 00000
CLOCK
SOURCE = INTERNAL
CLOCK  10 NANoseconds
INPUT MODE = SAMPLE

NOAUTO REFRESH      ARM MODE
ARM MODE = MANUAL      ARM CHANNELS = MAINS & HS

SET UP MAIN TRACE

LVL  COMMAND SEQUENCE:
0: TRACE UNTIL SAMPLE = EVENT 0
1: TRACE UNTIL SAMPLE = EVENT 1
2: LINK ON ENTRY TO LEVEL
   TRACE UNTIL SAMPLE = EVENT 2

```

Example 18A

LINKING HIGH-SPEED AND MAIN TRACE (PART 2)

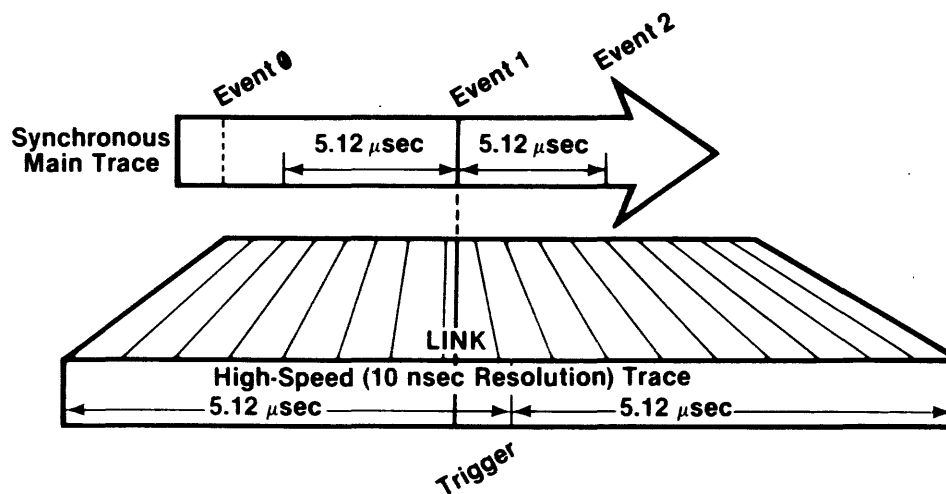

Purpose: Change the window in time the high-speed recording (from Part 1) takes place.

Benefit: Better definition of high-speed window position varies the perspectives making it easier to spot causes of program misexecution.

Example 18B

LINKING HIGH-SPEED AND MAIN TRACE (PART 2)

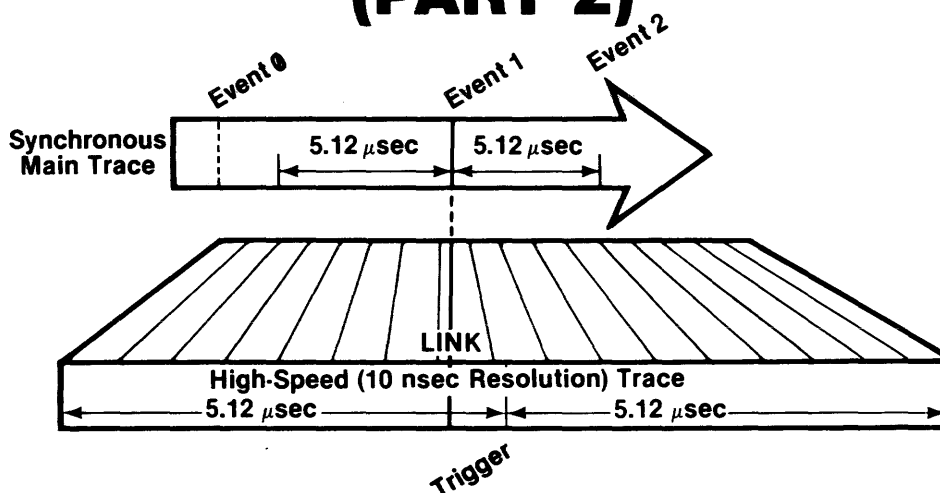

```

SET UP HIGH SPEED LINKED
RADIX:      B B B B B B B B B B B B B B B B
CHNL SEQN:  F E D C B A 9 8 7 6 5 4 3 2 1 0
TRIGGER:    IF 1 1 1 1 1 1 1 1 1 1 1 1 1 1 1 1
             BECOMES TRUE & REMAINS TRUE FOR 01 SAMPLES
             THEN STOP AFTER 00512 LINKS

```

COMMENTS

Use the main trace control
setup from Part 1.

Now the HIGH-SPEED recording is centered around the trigger word (FFFF). More control is available by changing the "Then stop after _____" to another value, so the trigger is no longer centered in memory.

Note: "1" "0" or "X" can be used to define trigger.

Example 19

LINKING HIGH-SPEED AND MAIN TRACE (PART 3)

Additional methods of linking.

Parts 1 and 2 use link on entry to level.

In addition, "link on stop in level," "link on jump from level," "link on advance or jump," "link on first trace in level," and "link on advance from level" are commands available to link HIGH-SPEED and MAIN sections.

The HIGH-SPEED section can act as a stand-alone 8 or 16 input logic analyzer by changing the high-speed setup to "not linked."

Benefit: Any event or series of events can cause a link which will enable the HIGH-SPEED sections. The HIGH-SPEED sections can be configured to move the captured window by varying the delay. The window size can also be varied by changing the internal clock rate.

Advantage: High-speed close-ups (high resolution recordings) can be made using the MAIN trace control to define some link point in the close-up. The link point can be defined in a variety of ways, each offering its own unique perspective. By varying delay and high-speed sample rate, many different windows can quickly be examined for relevant information until the one sought after is discovered. Discovery is quick but highly sophisticated in definition.

DOCUMENT REVIEW FORM

K105-D LOGIC ANALYZER
USERS MANUAL

Publication No. 0117-0014-10
June 1984

Dear Customer:

Your comments concerning this document help us to produce better documentation for you.

GENERAL COMMENTS

- | | |
|--|---|
| <input type="checkbox"/> Easy to read? | <input type="checkbox"/> Complete? |
| <input type="checkbox"/> Well organized? | <input type="checkbox"/> Well illustrated? |
| <input type="checkbox"/> Accurate? | <input type="checkbox"/> Suitable for your needs? |

SPECIFIC COMMENTS AND CORRECTIONS

Reference	Page
-----	-----
-----	-----
-----	-----
-----	-----
-----	-----
-----	-----
-----	-----

Please send your comments to:

GOULD INC., DESIGN & TEST SYSTEMS DIVISION
4600 Old Ironsides Drive
Santa Clara, Calif. 95050-1279
ATTN: Publications