

# RCA Computer design

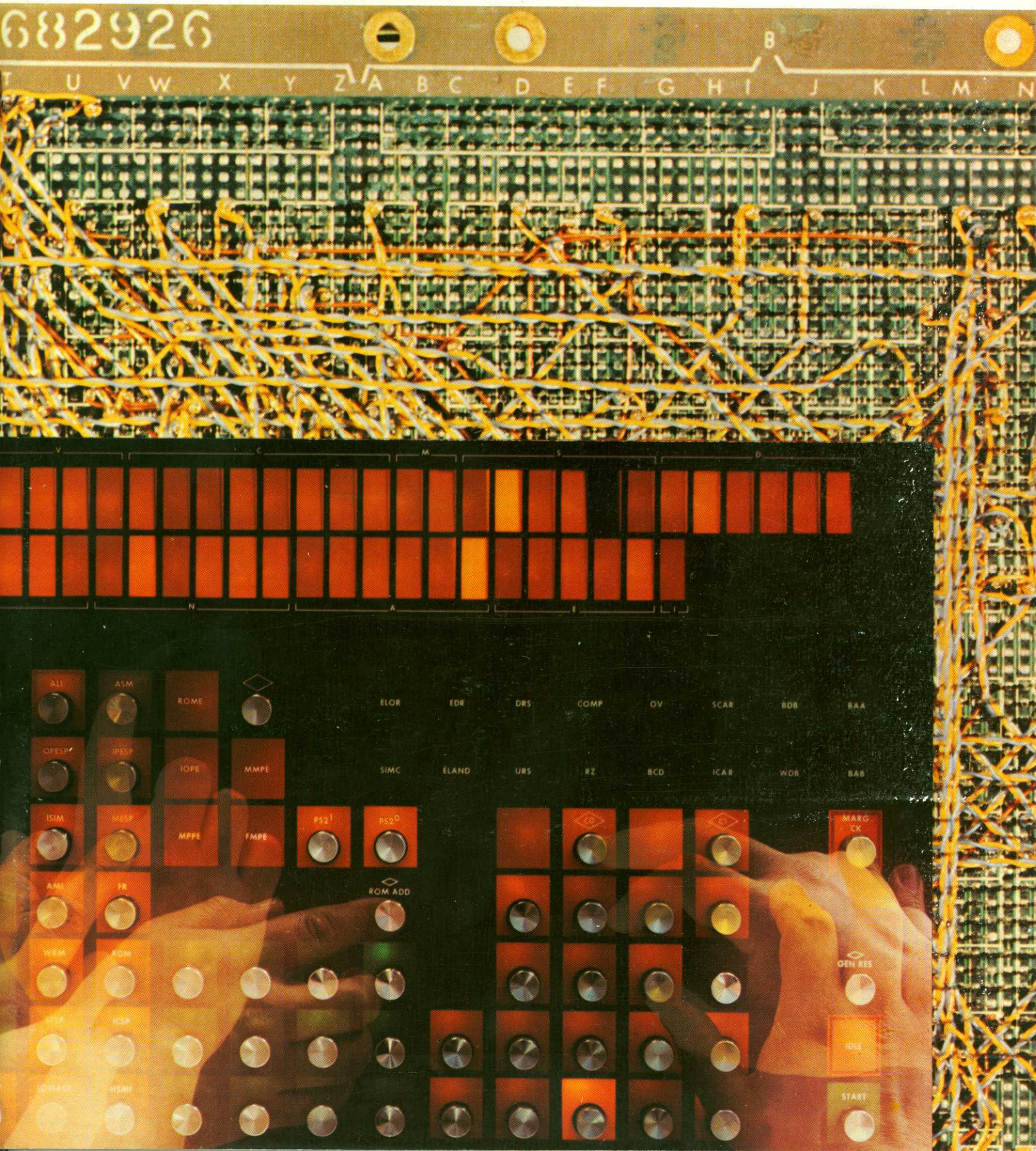

# Computer design

## Contents

---

### Papers

RCA computers: a technical review and forecast	B. W. Pollard	2
A purview of RCA's computer business	J. J. MacIsaac	7
An earth resources satellite	Dr. H. M. Gurk, B. P. Miller	10
Controlling noise in logic circuits	R. G. Saenz, E. M. Fulcher	15
Circuit concepts for the series 1600 computer	J. W. Haney, D. B. Ayres	20
Installation of computers	B. Aaront	24
Site planning and air conditioning of EDP rooms	L. K. Jurskis	28
Digital computers in space engineering	R. Goerss	32
Engineering school to industry	B. A. Bendel	36
Surface-state density from high frequency capacitance measurements	Dr. K. H. Zaininger	38
Methods of programming for numerically controlled production	Dr. R. L. Rosenfeld	41
Automatic generation of tests for combinatorial logic	H. I. Hellman	46
Computer-aided design of integrated-circuit platters	H. R. Beelitz, C. T. Wu	49
Digital control of Videocomp	S. A. Raciti	54
Application of retrodirective antenna systems to spacecraft	W. B. Garner, D. Z. McGiffney	58
Photo-dielectric tape camera systems	J. A. D'Arcy	62
The roll-up solar array	G. Kopelman	66
A partitioning algorithm for design automation	J. Smiley	70

---

### Notes

Data transfer circuit	W. A. Helbig, Sr., W. J. Davis	73
Looking into an ME's bag of tricks: investment casting for airborne equipment	W. Blackman	73
Thermal greases for heat conduction across sheet-metal interfaces	E. D. Veilleux	74
A fluid damper for spacecraft nutation	K. Ayache, R. Lynch	76
Data error rate improvement by redundant transmission	C. Mengani	77
Integrated S-band upconverter	P. Bura	78

# RCA computers: a technical review and forecast

B. W. Pollard

No review of computers, either in the data processing world at large, or within RCA, can cover all facets. It is therefore the object of this review to focus upon the primary purpose of the computer in the RCA market environment, to discuss how that purpose has been fulfilled in the past and the present, and to forecast future trends.



**Brian W. Pollard, Mgr.**  
Engineering—Camden  
Information Systems Division  
Camden, N.J.

received the BA and MA in natural and mechanical sciences from Clare College, Cambridge in 1944 and 1948. He joined RCA in January 1966 as manager of product planning for EDP. He was appointed to his present position in June 1967. Prior to joining RCA, he was with Burroughs Corporation from 1959 where he was director of engineering—data processing, and manager, data processing activity. From 1948 to 1959 he was with Ferranti, Ltd., England, and held the position of manager, computer department. He was chief US delegate to the first three international data processing standards conferences (1961, 1962, 1964); technical program chairman for the spring joint computer conference in 1963; and general conference chairman for the SJCC in 1967. He has nine patents issued, and is a senior member of the IEEE, and member of the IEE (UK).

**A**LTHOUGH THERE IS A SIGNIFICANT OVERLAP, the two major applications of computers can be characterized as *commercial* and *scientific*. The major market is the commercial one, covering the private and governmental enterprises of the country. Less than 20 years ago the first commercially built computers were delivered to customers. Today over 30,000 computers are integrated into the day-by-day

Final manuscript received December 11, 1968.

operations of industry, commerce, and the government.

## System emphasis

In the past, and still today to a degree, computers have been announced, and sold, on the basis of the technologies employed, the circuit speeds achieved, the construction techniques adopted, and so on. Today, and more so in the future, the emphasis is upon the capability of the *system* to do the tasks the customer requires to have done. It is at this point that the careful use of the word *system* rather than *computer* must be explained. By system we mean the total complex of hardware, software, and human operations that is required to function as an entity to perform the required tasks. It is this system, or at least the hardware and software components of it, which the customer expects to receive from the manufacturer.

## First generation

It is then in this context of commercial systems that this review of RCA work will be made. In 1950, RCA undertook a study of market areas related to data processing and identified a need for a large commercial data processing system structured around the commercial needs for sorting, merging, deleting or extracting data, together with manipulation and decision making. Accordingly RCA undertook the development of such a system for the Army Tank and Automotive Command. BIZMAC was, of course, a tube machine and was also the largest data processing installation delivered at that time (1955). It used 32,000 tubes and 600,000 other components, and yet had a maximum memory size of only 8,000 7-bit words.

It had, however, many advanced systems concepts:

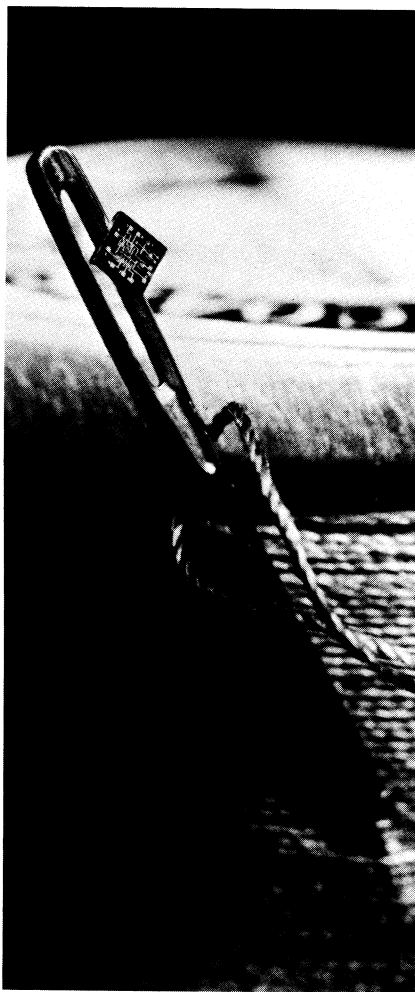
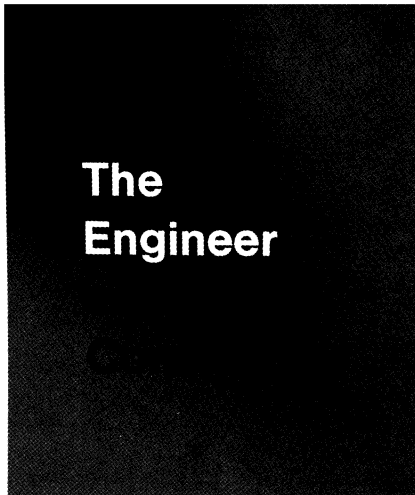

The integrated circuit (above)—being passed through the eye of a needle—contains approximately 15 transistors and 13 resistors. The IC was one of the major reasons for the drastic hardware-size reductions of the third generation computer.

The first commercial variable word length computer;  
A powerful and sophisticated set of 3 address instructions;  
A unique program library system using magnetic tapes and special tape readers;  
A special hand-wired program machine, the Sorter, for file resequencing, instructing, merging, and the like.

As can be seen from Table I, its speed—both circuit and memory—was rela-

tively slow by today's standards, but its capability for data manipulation of all kinds, and the minimized manual intervention, made it, as a system, well ahead of its time. For all its sophistication, it was still a first-generation computer, with programming done at the machine-code level; this allowed the (user) programmer to exploit the idiosyncrasies of the hardware, but of course severely limited the magnitude of the programs which could reasonably be written.

A later version of BIZMAC permitted sorting to be performed on the main processor, rather than on specialized hardware. Also some simultaneity of I/O operations with internal operations was provided for, although this had to be optimized in detail by the programmer.

### Second generation

The second generation of RCA equipment consisted of the 501, 301, and 601 in order of announcement. Second generation equipment is usually characterized as that which started to use semiconductors rather than tubes. However, there was another and important characteristic—the development and use of software which was somewhat more remote from the *machine code* of earlier systems. Procedure-oriented languages started to be used, and a wider variety of service programs were developed, including ones which permitted automatic execution from one job to another, and assignment of peripheral devices. Also during the second generation, problem-oriented languages began to be developed; one of the earliest COBOL compilers was developed by RCA.

The 501 was relatively slow, but it did allow for a large core store (up to 262,000 7-bit words) and it was the first commercially delivered transistorized computer. The 301, which came two years later, had very significant performance increases and had a characteristic which contributed significantly to its long life and popularity. It was the first computer to be designed with a generalized interface which simplified the design of electronics to attach literally any kind of peripheral equipment. Earlier systems had always required major surgery if a new peri-

pheral device was to be added after the design had been completed.

The 601 was planned to provide a system which was somewhat more oriented to the scientific world in that it provided powerful computational capabilities. In addition it utilized an interrupt scheme and provided multi-programming capabilities.

### The RCA 3301

Between the second and third generation, RCA developed a system which combined many of the characteristics of the 301/501 class and the 601 into one system, the 3301. This system was provided with major software support in the area of languages, service programs and operating systems.

### Third generation

The third generation of equipment has been variously defined, but the salient characteristic of these systems is their use of sophisticated operating systems that allow the user programs to be essentially decoupled from the specific hardware in use. The user is able to develop his programs in a high level language, such as COBOL or FORTRAN and then have these programs compiled and executed on systems appropriate to his needs. This decoupling from the hardware would be significantly more difficult if, as in the past, every computer had been designed as a unique, free standing device. Hence, another characteristic of the third generation, with some manufacturers at least, has been the adoption of the concept of compatibility. This concept requires that systems with a range of performance (speed) shall have essentially identical characteristics. Hence operating systems (and compiled programs) may be run without modification on systems within the compatible family.

The Spectra 70 family is, of course, a compatible family of systems, with, in addition a very significant degree of compatibility with RCA's major competitor—the IBM system 360. This compatibility with system 360 does not extend to all of the features which are used only by the operating systems. Thus there is no interchangeability of operating systems, but user programs may be compiled and executed under the operating systems of either family.

This form of compatibility means that any comparison of system performance must take the operating system into account, as well as the circuit and memory speeds of the computer. There is therefore another dimension, software, in any table of competitive performance. So far, with the Spectra 70 family, not only has each member of the family outperformed the equivalent member of the competitive family, but each of the RCA operating systems has been more efficient and hence faster than those of the competition.

When the Spectra 70 family was last discussed in the RCA ENGINEER (Volume 11, No. 3, October/November 1965) the family consisted of the 15, 25, 45 and 55 with the 70/35 announced just as that issue was going to press. Since then, the Spectra 70 time sharing system (70/46) has been announced and production units delivered; also, there has been a significant increase in the maximum data rate for the selector channels of the 70/45.

This review began with a discussion of the commercial market and its implications. How have the RCA systems fitted into this market, and what is the future?

### RCA equipment today

The second generation was a learning period. A large number of computers (probably 20,000) was built and installed and users became accustomed to having their computer systems intimately (and intricately) involved in their day-to-day operations. However, in general, each job was run separately and distinctly from each other job, and the total workload was accomplished by the use of multiple systems, each handling a given number of tasks. Since no integration between these tasks was possible, there was wasteful duplication and overlapping. Furthermore, programming in relatively elementary and unsophisticated languages made the development of lengthy programs difficult and time consuming, and modifications (by anyone other than the original programmers) virtually impossible. The RCA systems were in line with the general trend during this period, and the 301 particularly may be counted as a very successful system. In the second generation, sophisticated users recognized the

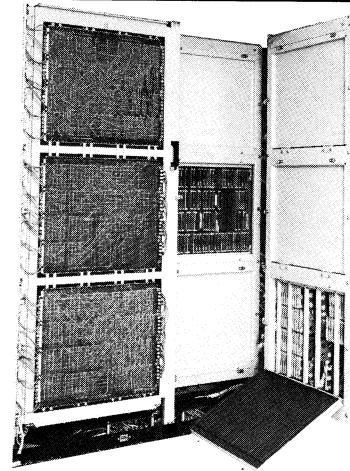
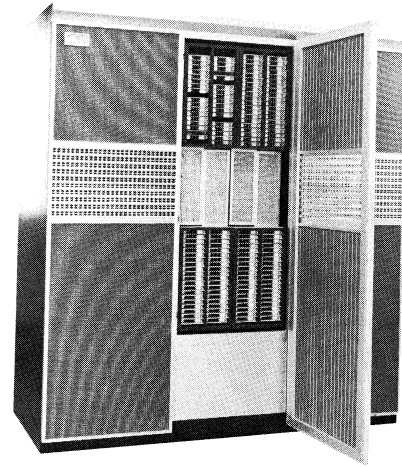
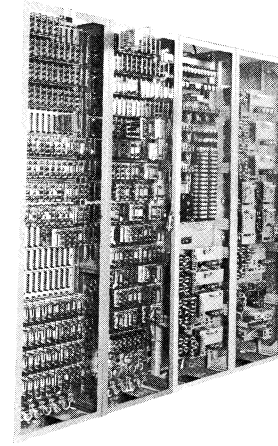
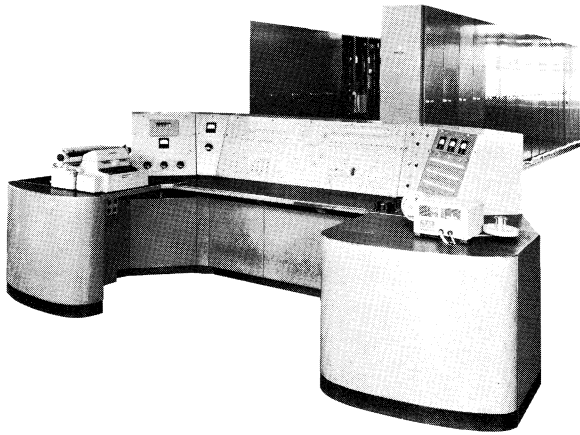

The Bizmac computer (top) was the largest data processing installation in 1955; it had a maximum memory size of 8,000 7-bit words. The RCA-501 (middle) was one of RCA's second generation computers; it was relatively slow but could store up to 262,000 7-bit words. The Spectra 70 (bottom) represented significant advances in the use of operating systems and in compatibility.

Advances in packaging have been among the most dramatic changes from the first through the third generation: top, Bizmac packaging; middle, RCA 601 packaging; bottom, Spectra packaging.

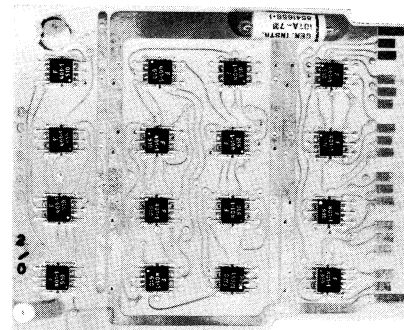
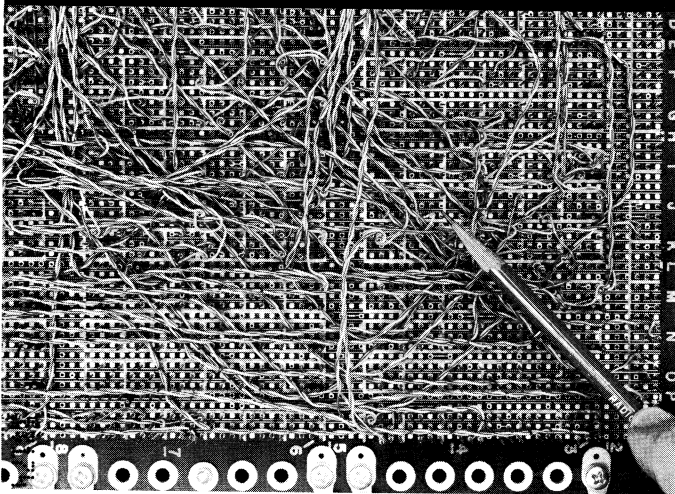
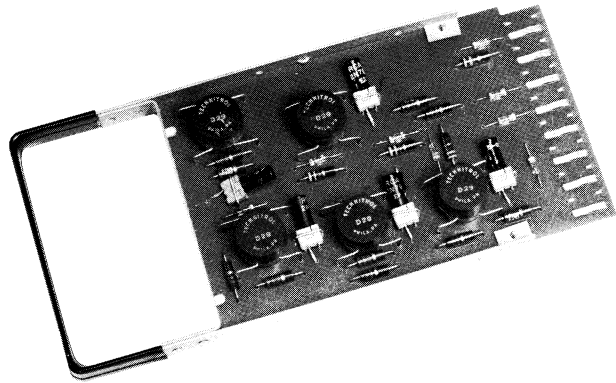
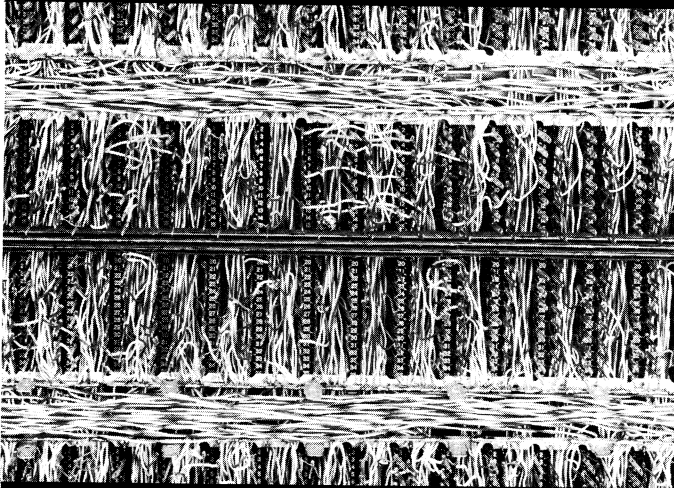
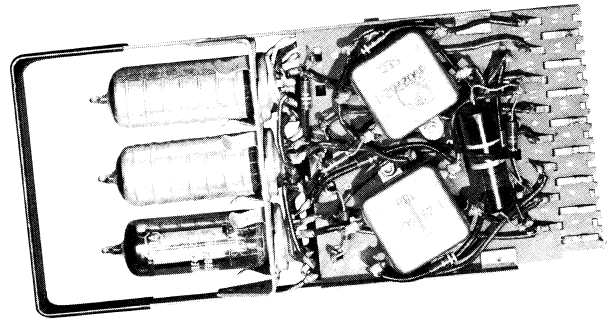
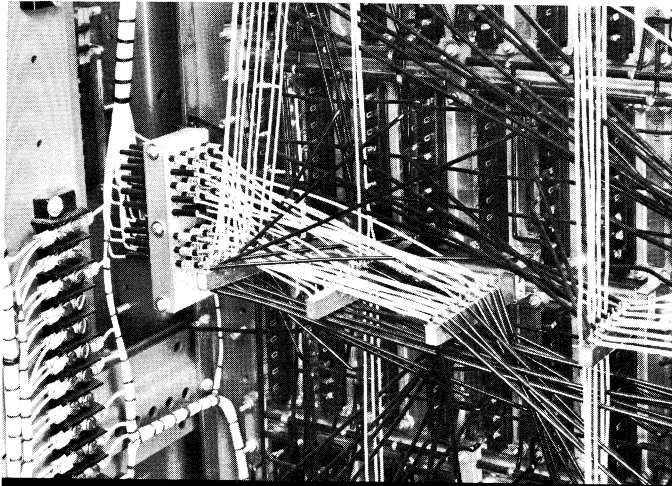

Corresponding to the packaging advances came improvements in wiring from the hard wired Bizmac (top) to the more compact RCA-601 wiring and ultimately to the printed wiring of the Spectra series.

From tubes to transistors to integrated circuits, the module sizes continually decreased and functional sizes increased. At top, the Bizmac tube-type board contains one flip flop; middle, the transistorized RCA-501 board contains about two flip flops; the Spectra board bottom, has about eight flip flops.

Table I—Chronology of RCA computer systems developments.

<i>Computer</i>	<i>Date announced</i>	<i>Circuit speed (ns) and type</i>	<i>Memory cycle time (<math>\mu</math>s)</i>	<i>Size range (bits per word)</i>
BIZMAC	Nov. 1955	250 diodes/tubes	20	4-8 K/7
501	Feb. 1958	1,000 resistor/transistor	15	16-262 K/7
301	Feb. 1960	230 diode/transistor	7	10-40 K/7
601	Feb. 1960	90 diode/transistor	1.5	8-32 K/56
3301	Feb. 1963	50 diode/transistor	1.5	40-160 K/7
70/15	Dec. 1964	60 diode coupled nand	2.0	4-8 K/8
70/25	Dec. 1964	60 diode coupled nand	1.5	16-65 K/8
70/35	July 1965	24 emitter coupled current mode	1.44	32-65 K/8
70/45 I	Dec. 1964	24 emitter coupled current mode	1.44	65-262 K/8
70/45 II	Mar. 1968	24 emitter coupled current mode	1.44	65-262 K/8
70/46	Apr. 1967	24 emitter coupled current mode	1.44	262 K/8
70/55	Dec. 1964	24 emitter coupled current mode	0.84	65-524 K/8

weaknesses of the relatively simple systems that were available, and looked for an integrated system which could truly perform all of the tasks required. The third generation, with its emphasis on operating systems, went a substantial way to meet this need.

### Operating systems

The Spectra 70 systems currently have six announced operating systems: pos (Primary Operating System), tos (Tape), dos (Disc), tdos (Tape-Disc), mcs (Multi-channel Communications System), and tsos (Time Sharing). Each of these operating systems should (and must) be considered the equivalent of a major hardware product. It requires many man years of development; it must be very thoroughly tested prior to release; it must be very well documented, not only for the users, but also for those who come later and may wish to make modifications. Because of its complexity, and in spite of prior testing, errors are sure to be discovered

in use; these must be corrected and the operating system updated. It should come as no surprise to note that there are approximately as many Systems Programmers as there are Design Engineers in the Information Systems Division.

As indicated earlier, these operating systems have been shown to perform very competitively and they, in conjunction with the Spectra 70 hardware, have provided a solid base for rapid growth.

### Communications capabilities

In meeting the user's need for an integrated system, in addition to being able to readily run multiple tasks or jobs and easily reassign peripheral devices from job to job, a communications capability is of major importance. The Spectra 70 family, with its 70/668 Communications Controller-Multi-channel has been shown to have great capability in this area. The combination of RCA's excellent reputation in

the communications field and the capabilities of Spectra 70 has resulted in significant successes. With the users tending more and more to the use of their own, and the common carriers' communication networks, the RCA communication capabilities are proving to be highly competitive.

### Future trends

Thus it may be stated that the current RCA systems (hardware and software) are in the very center of the most important trends of third generation requirements. What of the future? Sometimes it is questioned whether there will be a recognizable fourth generation; certainly the traumatic shift from second to third generation, with all of its needs for emulation and reprogramming is not likely to be attempted again. Hence evolutionary steps are the most probable, with significant compatibility being retained. As more users recognize the value of centralized data bases, so will the need for large and economic random access memories grow. Centralized data bases imply a significant amount of centralized computing, if only to keep their data bases updated. Centralized systems also imply complex communications networks, since there can be no justification for such a centralized system if it is to be a bottleneck to the enterprise which uses it. With a centralized data base, inquiries to that data base are to be expected and provided for, since the data base provides the latest and best information that is available. Hence we may expect such a system to be active during the day (11 hours coast to coast) with inquiry-response and vital outputs, and to use the remainder of the 24 hours for updating, data manipulation, and report preparation, to say nothing of inquiry-response from overseas for major international corporations. Thus these systems must be oriented toward large scale data storage, complex communications, time sharing (to allow for complex, as well as simple inquiry-response), and because of the scope of the overall task, be capable of running on a 24-hour, 7-day-a-week basis, with the minimum of human intervention. RCA's experience, technology, and capability provides a strong base for meeting these requirements of the future.

# A purview of RCA's computer business

J. J. MacIsaac

Every major division of RCA is involved in some way with the collection, transmission, storage, retrieval, conversion, and analysis of information; therefore, it is not unusual that the Information Systems Division should be largely devoted to the development and installation of computer-communications systems. Also, it is not unusual that the release of the Spectra 70/46 time sharing system and its allied software package, the Time-Sharing Operating System (TSOS), now places the company in a lead position for tomorrow's time-sharing market.

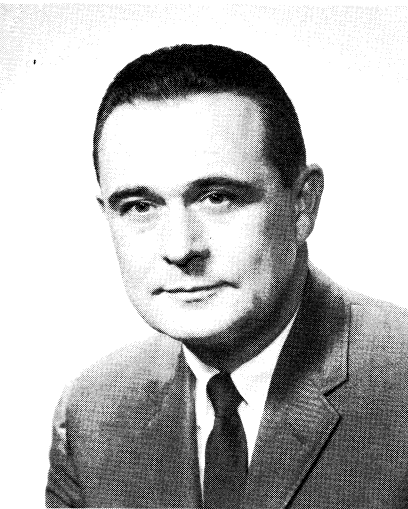

J. J. MacIsaac, Mgr.  
Market Planning  
Information Systems Division  
Cherry Hill, N.J.

received the BS in Marine Engineering and Naval Architecture, the MSE in Systems Engineering from the University of Michigan. Mr. MacIsaac was formerly associated with SCM Corp. in New York for more than four years as Vice President of the Data Processing Systems Division and Vice President of OEM Operations. Prior to that he was Director of Business Planning for the Diebold Corp. for two years. He has also served in management positions with Univac and the Stanford Research Institute. In his present position, Mr. MacIsaac is responsible for all long and short range planning for RCA's computer division.

**T**HIS YEAR, INDUSTRY DOLLAR SHIPMENTS of computer hardware should be slightly greater than in 1968, increasing the cumulative value of systems installed by about 20% a year. An average rate of 15% should continue through the early 1970's, with certain areas of the market expected to expand more rapidly.

Chief among these will be communications and time sharing systems, whose growing popularity reflects a shift on

the part of many computer users to combined batch, on-line and time-shared processing. This will generate a need for new equipment—particularly remote terminals and mass storage devices—with a resultant impact on the peripheral systems market.

## A look ahead

Concurrently, about 12% of computers installed around the world are communications-oriented. However, by 1975, 60 to 70% of all installed computers probably will be operating in a communications environment.

Many of these installations will be fourth-generation computers featuring improved third-generation architecture and machine organization. Inexpensive, small CRT display devices will be more readily available, and lower cost typewriter keyboards will permit rapid data entry to the computer plus high-speed information printout.

Fourth generation computers also will surpass current third-generation computers in their ability to unify batch processing and terminal transmission and perform many activities simultaneously.

*Businessmen*, using desk-top terminals, will query computer system records for needed information, even while the computer is processing engineering equations.

*Students*, using typewriter and visual display terminals, will answer computer-given questions, even while the computer is preparing next week's education program or producing next semester's classroom schedules.

*Housewives*, using touch-tone telephones will conduct routine financial transactions (such as, depositing money

## The Engineer and the Corporation

and paying bills). At the same time, a small numeric printing terminal will provide an instant record so husbands can reconcile these transactions on a daily basis.

*Architects*, using special graphic display terminals, will design buildings and have the computer automatically transform these designs into materials specifications, even while the computer is producing construction schedules for other buildings.

*Doctors*, using typewriter terminals to designate patient symptoms, will have the computer diagnose the illness, even while the computer is updating daily hospital records and preparing forms for insurance company submission.

*Motor vehicle departments*, using sensors placed along major traffic arteries, will have the computer analyze vehicle flow and schedule traffic light changes to achieve optimum vehicle movement.

These and other communications-based procedures even now are possible, many on systems such as the Spectra 70/45. Future communications/processing needs may be more economically handled, however, by time sharing systems such as the 70/46, or by 70/45's programmed for time sharing operation.

## Principles of time sharing

Movement to time-shared processing is a natural and logical consequence of improvements in computer capability coupled with man's desire to obtain greater processing power for the dollar.

Time sharing simply means the apparently simultaneous use of a single computer by several users (each user is unaware that there are other users). The user may be a company, a division or branch of a company, an institution,





RCA's new Corporate Information System Center at Los Angeles has the capability for handling inputs from remote card and paper-tape terminals.

a government agency, or even a group of dissimilar organizations requiring access to a central processor. Each user receives a share of time available, and many jobs are performed simultaneously within a time period.

This cooperative use can be achieved in several different manners: by interspersing programs rapidly on one computer; by multiprogramming; or by multiprocessing—using two computers that are joined to permit the sharing of each other's facilities. Multiprogramming enables several jobs to be handled concurrently, and is now considered the basic mode of almost all time sharing systems.

Multiprogramming is done by interleaving programs of the central processing unit, storage, and input/output devices. To do this, the control programs and equipment identify the point at which a problem program being executed must "wait" for the completion of some event. Then the control program begins another processing task that is ready to be executed. After this is accomplished, the control program goes on to something else or goes back to the previous, unfinished program. Since many programs may be in stages of partial completion, successful multiprogramming requires scheduling of levels of priority for the different procedures.

Multiprogramming, of course, has been a feature of some batch processing systems for some time. However, in a batch processing environment one usually thinks of three to six concur-

rently active operations, whereas in a time-sharing system 30 to 100 operations are considered typical.

In today's time-sharing system, the user also enters commands from a terminal, compared to batch processing where commands typically are entered by paper tape or punched card. This makes the control function more complex, for with terminal input, the system must be capable of accepting the command and giving the user a few hundred milliseconds of processor time. If the user's job is short and finishes in that time, he will receive the answer within seconds at his terminal. But, if the job is not short, time must be allocated for interspersment among other processing jobs so as to achieve rapid job completion.

From this description of time sharing principles, one might conclude that software is the fulcrum of system performance. But remember, in a time sharing system all the special data and commands must be rapidly shuttled between internal and external memories and between processor and input/output terminals. Furthermore, this data must be moved as single packages, and each package must be isolated so that data will not "leak" from one to another and interfere with the solution of another problem.

The best insurance of a marketable time sharing system is one which is engineered to provide full processing flexibility for the least possible dollar investment.

### RCA's time sharing position

Right now, RCA's Spectra 70/46 stands virtually alone in its ability to provide time sharing with a medium-scale computer. Since its release in 1967, it has come to be known as one of the best time sharing systems in the industry, incorporating features that probably will be included in most future industry time sharing systems.

This year, sales of the Spectra 70/46 will become a significant part of ISD's dollar volume. And, by 1975, it is anticipated that 75% of all sales activity will involve time sharing equipment.

RCA's Time Sharing Operating System (TSOS) also is one of the industry leaders, and of all advanced operating systems probably offers the easiest man-machine interface of any system of equal sophistication. TSOS incorporates a direct access, extended multiprogramming capability enabling concurrent local batch processing, remote batch processing, and interactive time sharing from remote terminals. TSOS also is capable of controlling up to 48 terminal users and up to 16 tasks in the background, thus enabling optimum computer utilization with little degradation in response time to terminal users.

### Time sharing applications

Of the Spectra 70/46 time sharing systems sold last year, applications will be wide and varied. At the Moore

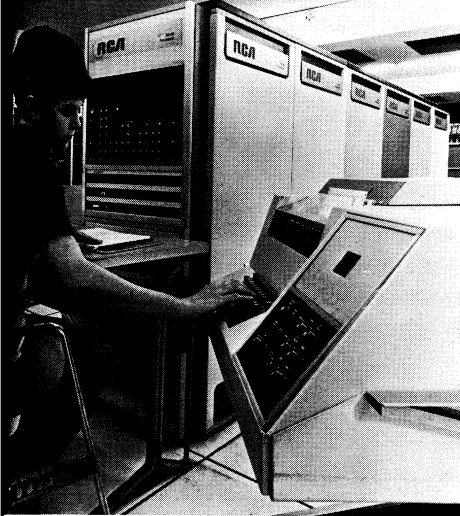

An RCA Spectra 70/46 time sharing system at Cherry Hill, N.J., was linked to a battery of remote video data terminals in RCA's exhibit at the 1968 Fall Joint Computer Conference. This system handles normal batch processing and, at the same time, provides remote terminal services to problem solvers, programmers, and those who seek immediate access to data banks for inquiry and response.



RCA Spectra Video Data Terminals being used by the Crime Information Center in Cincinnati, Ohio.



The RCA Spectra 70 Data Gathering System collects data and transmits it directly to a Spectra 70 computer or to a stand-alone controller for temporary magnetic storage—thus, providing a timely and reliable picture of business activity as it occurs.

School of Electrical Engineering at the University of Pennsylvania, researchers for the first time will have access to a large system that can be exclusively for computer research projects. At this time, these include 35 different procedures, including computerized studies of the human body, computer analysis of electric power systems designed to prevent blackouts, and production of educational films that use animation generated by a computer. Equipment used here includes a 70/568 mass storage unit, two disc drives, and various terminal devices.

For Burlington Industries, Inc., the Spectra 70/46 represents an additional source of revenue. The system, which will be used exclusively by Burlington Management Services Co., a division of the parent company, will provide interactive time sharing and remote batch processing simultaneously for industrial and other BMSC clients.

Work along similar lines also is getting started at Westinghouse Information Systems Laboratory in Pittsburgh, Pa. Here, however, the system will be used for customer numerical control operations.

Westinghouse has used various computers since 1962 to pioneer numerical control (N/C) techniques, including development of the Campoint N/C System—a special corporate software package. With the Spectra 70/46, Westinghouse expects to enhance this program by permitting outside manufacturer utilization and sharing of numerical control experiences.

Beginning this summer, Franklin and Marshall College, located in Lancaster, Pa., will lease its 70/46 to the Middle-Atlantic Education and Research Center, a non-profit corporation composed of six small schools and two research groups within a 100-mile radius of Lancaster. This marks the first time a group of small institutions has banded together as a cooperative to use a sophisticated computer for education and research. Some 35 teletypewriters will be linked to the computer from the various institutions, with the system operating up to 10 hours a day for 8,500 students, faculty, and researchers.

The University of Dayton (Ohio) also will be making available its 70/46 to other colleges who, with Dayton,

comprise the Dayton-Miami Valley Consortium. With this \$1.5 million installation, research, administrative, record-keeping and academic functions will be handled in a simultaneous batch and remote processing environment.

From these and other imminent installations—Equitable Life Assurance, Connecticut General, Lockheed Aircraft, Owens-Illinois, and others—it is apparent that RCA is off to a solid start in the run for time sharing leadership. But, for this momentum to be continued, constant software improvement and consistent updating of hardware capability will be required.

### Future time-sharing requirements

Changes in time shared processing will occur slowly. But they will occur. Tomorrow's systems will have to provide greater power for the dollar. This will require a closer alliance between software and design, thus a greater system's knowledge on the part of engineering.

*Reliability* will have to be assured, not only in the central processor but in all peripheral devices.

*Terminal capability* will have to be expanded. Besides visual display and typewriter devices, on-line graphics will be necessary.

*Greater simplicity* of system operation will be needed to provide faster and more efficient man-machine communication in a variety of unrelated processing environments.

RCA already is striving to meet these requirements—through development of better software procedures; and through total commitment to time-sharing market development.

All companies, of course, are seeking leadership in time sharing systems. And, for the moment at least, it's a wide-open market.

No company, however, or pair of companies, can match RCA's experience in the field of communications. Nor is there a company that can match RCA's experience in electronic display. These two factors, coupled with current Spectra 70/46 success, has to make RCA a leading contender among all computer producers.

# Circuit concepts for the series 1600 computer

J. W. Haney | D. B. Ayres

This paper traces the evolution of the circuit design for the series 1600 computer. A general approach to selecting an integrated circuit is presented, followed by the specifics for this particular application. A functional description of the circuit is given and the trends for this type of integrated circuit are discussed.

**G**IVEN THE TASK of specifying an integrated circuit for a particular application, there are nine areas that must be explored:

- 1) The Manufacturer
- 2) Fan-in, Fan-out (Current & Voltage Compatibility)
- 3) Speed
- 4) Noise Immunity
- 5) Power Supply Requirements
- 6) Power Dissipation
- 7) Family Logic Variations
- 8) Cost
- 9) Vendor Compatibility

## General considerations

### Manufacturer

The prime vendor or vendors must be major manufacturers of integrated circuits. Items for consideration are:

- 1) The engineering capability of the vendor.
- 2) The production capability of the vendor.
- 3) The total dollar volume of business with RCA.
- 4) The number of licensees or other manufacturers that produce the same products.

When considering engineering capability, it is important to gauge the appreciation of the vendor's device engineers regarding systems problems. The sources of noise in the system and the parameters of the integrated circuit that have major effects on system performance, and cost must be a mutual concern of the circuit designer and the device designer. Examples of these parameters are given in a subsequent article on "End of Line Reflections," and "The Pedestal Reflection."

The schedules and commitments of integrated circuit manufacturers are controlled to a large degree by Marketing. The engineering activity of the device manufacturer must be able to recog-

nize the need for technical changes in the product and have prompt action effected once a decision is made between the circuit and device engineers. The influence of the vendor's engineering department in his own house is very important to the system designer.

The production capability of the vendor is important. The best engineering talent in the world is useless unless the vendor has the capability to produce a reliable device and in the quantities needed. There are several yardsticks that can be applied to determine this. The past performance of the vendor, while doing business with RCA, can be provided by the purchasing department of RCA. They have local, as well as Corporate, history that is most helpful.

A plant visit can also be enlightening in this regard. A very desirable design goal is to specify as near as possible the vendor's product line device. His projected volume and existing production schedules then become pertinent. An RCA volume in addition to an industry volume, results in a lower unit cost than if the circuit is an RCA special.

The total dollar value of business that a vendor transacts with RCA is another consideration. If the amount is appreciable, it is sometimes very helpful to solicit the aid of RCA's purchasing activity in scheduling prototype parts for the design phase. They can overcome a lot of vendor inertia. Another item that a large volume of business can affect is component price. Sometimes the total dollar value in other areas can affect the price of an integrated circuit as much as, if not more than, the quantity.

It is axiomatic that two major integrated circuit manufacturers must be approved suppliers; however, after this



**J. W. Haney, Mgr.**

Memory and Power Supply  
Design Engineering  
Information Systems Division  
Palm Beach Gardens, Fla.

graduated from the Citadel in Charleston, South Carolina, in June 1956. He joined RCA on the engineering training program in June 1956, entered the Air Force in September 1956, and served as a Wing Communications Electronics Officer in the Strategic Air Command until April 1959. He returned to RCA in 1959, joining the Comlognet Design Group in Camden, where he worked in Memory Design for the Comlognet systems. In August 1962, he transferred to EDP, Palm Beach Gardens, Florida, with the Circuit and Memory Design Group. In July 1964, he was promoted to Engineering Group Leader, in Sustaining Engineering for BPU, Memories, and Power Supplies. In February 1966, he was appointed leader of Circuit Design Engineering. In May 1968, he was promoted to his present position. He attended the University of Maine and the University of Pennsylvania taking graduate courses in EE.

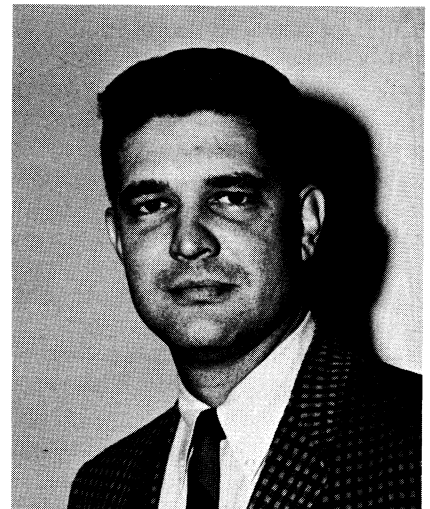

**Douglas B. Ayres, Ldr.**

Design Integration  
Information Systems Division  
Palm Beach Gardens, Fla.

received the BSEE from the University of Tennessee, Knoxville, in 1961. He was employed by Honeywell EDP, where he worked in the Circuit Design Group specializing in magnetic surface read/write circuitry. In 1964, he joined RCA-EDP, in Palm Beach Gardens. While in the Circuits Design Group, his primary responsibilities were in the field of analysing and specifying digital integrated circuits. In May 1968, he was promoted to his present position. Mr. Ayres has taken graduate work in electrical engineering at Northeastern University. He is the holder of two U. S. Patents.

has been effected it is extremely important to have secondary suppliers. It is quite advantageous to have at least one of the prime sources with an alternate that produces the same units. This further helps to protect RCA against having to be without components in the event of vendor problems. Licensees that can produce, but are lacking the full production capability of the larger companies, are valuable sources. There are times when the reaction time is less from the licensees.

**Fan-in fan-out (current & voltage)**

The fan-in and fan-out of the circuit to be considered should be given in terms of current and voltage as well as a number of like circuits it can drive.

This is done to indicate its capability to drive other circuits such as delay lines, one-shots, transmitter-receivers, as well as other types of integrated circuits.

**Speed**

The configuration of the computer logic dictates the speed of the circuit used. The circuit designer is usually given a maximum pair delay and the maximum skew (max PD - min PD) that can be tolerated in the logic design. This parameter is arrived at after many iterations that weigh the trade-offs between what is acceptable from a logic design point of view and what is possible from a circuit design point of view.

**Noise immunity**

When evaluating noise immunity before samples are available, the specification sheets of the vendor must be used. The DC noise immunity is specified by most vendors. This is not necessarily the worst-case noise immunity for the particular circuits; however, the voltage swing and the noise immunity can be used as a figure of merit for the particular circuit. Considerations must include not only the ability of a circuit to reject noises caused by other circuits; but should also take into account the ambient noise that exists from the electrical package, radiation, and other such effects. Noise immunity, of course, is considered from both the high and low level states of the circuit. The rise and fall time of circuits have a bearing on the speed and noise generating characteristics,

and should be considered when comparing circuit types.

A feel for the AC noise immunity can be derived by comparing DC noise immunity, voltage swing, rise and fall time, and circuit delay.

**Power supply requirements**

The number of power supply voltages required for an integrated circuit is also a consideration. Obviously, it is better to use one voltage rather than two, if circuit performance allows. This not only yields benefits in the power supply design, it also allows more pins for logic and less complicated power distribution schemes.

**Power dissipation**

Power dissipation within certain limits is not as important to the commercial computer designer as it is for many military applications; however, the speed-power ratio is a figure of merit of a circuit.

**Family logic variations**

The variations among members of a given integrated circuit family are not of uniform significance. For instance, the ECL circuit that provides a complementary output with each gate will not require as many family variations as will a TTL family. The TTL makes up for this with various gate configurations such as dual-4, single-8, and/or AND expanders, quad 2's, triple 3's, etc. An added advantage of TTL is that it contains "small arrays," such as the 16-bit memory elements that are located on a single chip. Within a particular IC family the number of variations is significant. To have a manufacturer create a set of masks to give a particular variation is very costly; therefore, the circuits that exist must be used where possible. Using the vendor's standard line allows for expansion at no development cost to the user when the vendor adds circuit configurations to this line.

**Cost**

At the outset, before the vendor is picked and the exact volume is known, a cost comparison for small quantities (1 to 999) is helpful. This relationship does not hold up as the volume increases, however.

**Vendor compatibility**

All circuit variations of a particular

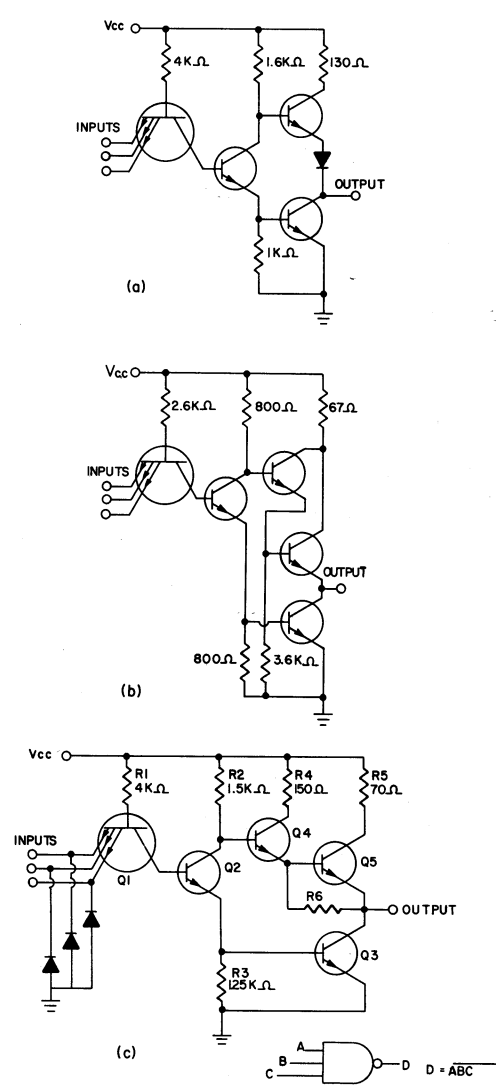

Fig. 1—Three circuit configurations: a) and b) were rejected, c) was the acceptable TTL circuit.

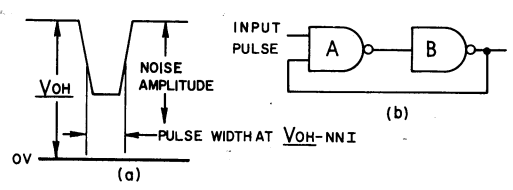

Fig. 2—Test for noise: a) input pulse, b) test circuit.

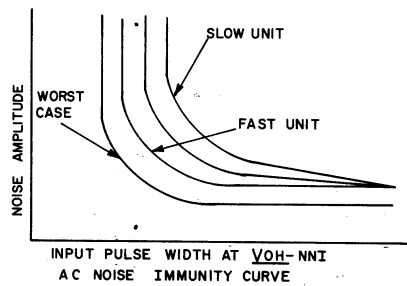

Fig. 3—Circuit noise measurements.

### The circuit chosen—and why

Comparative values derived from the nine general categories that were discussed in the previous section were used to select the type of circuit for the series 1600 systems. Each of the nine categories was weighed in light of the available integrated circuits. A scaling factor from 0 to 4 was used for each integrated circuit type. As can be seen from Table I, the items marked by an asterisk were multiplied by two as they were considered most important.

Table 1—IC Ratings

	TTL	ECL	DTL	CTL	VTL
Manufacturer	4	4	4	0	0
*Fan-in, Fan-out	8	4	6	6	2
*Speed	8	8	0	6	0
*Noise Immunity	6	4	6	4	8
Power Supply	4	4	4	0	0
Power Dissipation	3	2	4	3	1
Family Logic Variations	4	4	4	4	1
Cost	4	2	4	3	3
Vendor Compatibility	3	3	4	2	0
	44	35	36	28	14

levels and currents. These being the previously mentioned delay lines, one-shots, transmitter-receiver, etc. The ECL output was not compatible with these circuits.

The system packaging cost, plus the lack of compatibility with existing 2-series circuits, ruled out ECL.

These considerations, plus the large interest in TTL, which prevailed throughout the industry both in the USA and abroad (Siemens AG of Germany and Hitachi of Japan), made TTL the choice.

### Selecting the TTL family

Once TTL was chosen, it was necessary to decide which family of TTL to use. Its operation is essentially the same for all families considered. The gate circuit is characterized by a multi-emitter input transistor, a phase splitter, and an active pull up output. The high speed is a result of three factors:

- 1) The multi-emitter input transistor allows for smaller geometries, hence lower circuit capacities and faster switching;
- 2) The transistor action of the input stage in sweeping stored charge from the base of the phase splitter contributes to the fast turnoff of the device; and
- 3) The active pull up on the output gives the circuit a very low output impedance. This results in excellent capacitive drive capability.

The three circuit configurations considered are shown in Fig. 1. The circuit shown in Fig. 1a was not usable because:

- 1) The output impedance, with switching to a high level, is high enough to cause a pedestal in the threshold region;<sup>1</sup>
- 2) The circuit was too slow; and
- 3) Input clamp diodes, essential for controlling reflections, were not in the circuit.

The circuit shown in Fig. 1b was rejected because:

- 1) Poor AC noise immunity;
- 2) Fall time too fast; and
- 3) No input clamp diodes.

The circuit chosen, along with its logic symbol and Boolean equation is shown in Fig. 1c. This circuit was acceptable because:

- 1) The output impedance, when switching to a high level, is low enough to

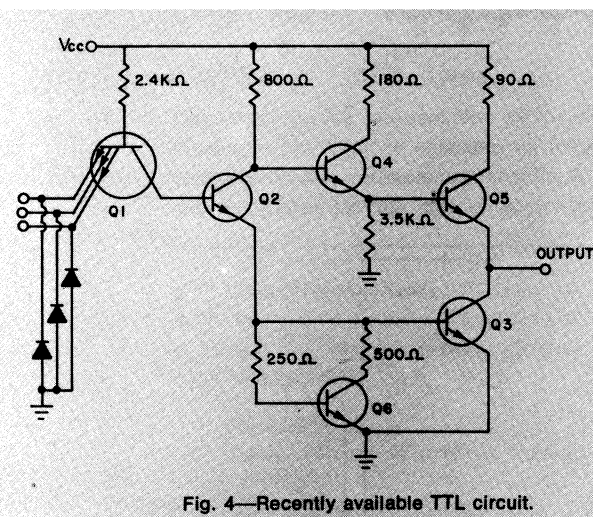

Fig. 4—Recently available TTL circuit.

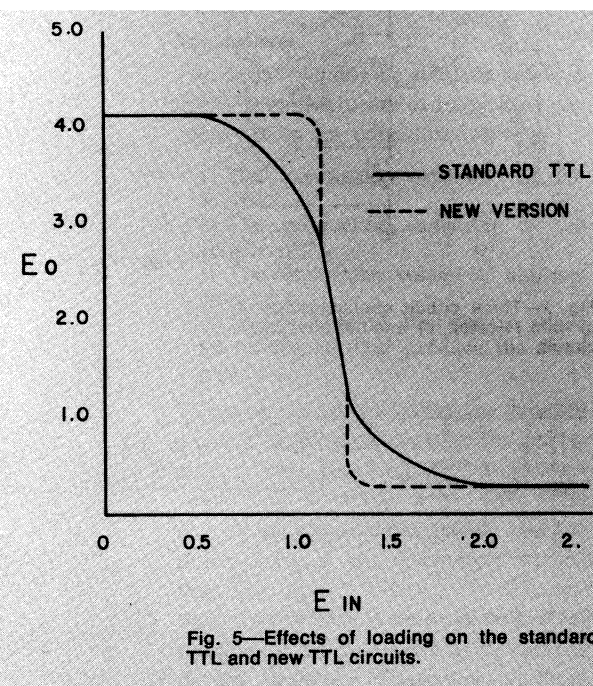

Fig. 5—Effects of loading on the standard TTL and new TTL circuits.

family must have the same voltage pins, supply voltages, and logic levels. The number of suppliers having units with these items in common provides an insight into the ease of multiple sourcing for a circuit family.

In considering the circuits only, DTL, TTL and ECL were quite close. There were, however, other application considerations that further affected the integrated circuit selection. The series 1600 system logic design could tolerate a worst-case pair delay in the order of 35ns; therefore, TTL and ECL met the speed requirements while DTL did not. This ruled out DTL.

The electrical package and its associated cost were a major factor in choosing between ECL and TTL. The package employed in the Spectra 70 computers using ECL was a known quantity. The platters, line terminators, and triple layer plug-in boards were estimated and compared to the 2-series package cost, also a known quantity. The 2-series package is used in Spectra 70 peripheral equipment and the 70/15 and 70/25 computers. It uses automatic wire wrap and printed backplane wiring techniques, and is less expensive than the platter approach.

The TTL circuits were tested using the 2-series package with double-sided plug-ins and found to be compatible, providing the backplane wire routing could be closely controlled. This was accomplished using the Gardner-Denver wire wrap machine with routing that was generated by design automation programs.

Many 2-series discrete circuits existed that were compatible with TTL voltage

prevent a pedestal in the threshold region;<sup>1</sup>

- 2) It met system speed requirements;
- 3) The vendors agreed to include the clamp diode in their standard lines; and
- 4) It has adequate AC noise immunity.

### TTL circuit description

When all inputs to the multi-emitter transistor  $Q_1$  (Fig. 1c) are held high, current flows through the base resistor  $R_1$  into the phase-splitter,  $Q_2$ , and to the lower output stage,  $Q_3$ . Transistor  $Q_2$  is in saturation, therefore, its collector is at a potential of  $V_{BE Q_3} + V_{CE(SAT) Q_3}$ . Transistor  $Q_3$  is in saturation with its collector current being supplied by the load. The output low level voltage is  $V_{OL} = V_{CE(SAT) Q_3}$ . Transistor  $Q_5$  is off;  $Q_4$  is either off or on by a trickle current.

When one or more inputs to the multiple-emitter gate  $Q_1$ , are low, no current flows to the base of  $Q_2$  and it is off; therefore,  $Q_3$  is off. The output high level voltage at this time is:

$$V_{OH} = V_{CC} - \frac{I_0 R_2}{h_{FE Q_4}} - V_{BE Q_4} - I_0 R_6$$

If  $I R_6 \geq V_{BE(ON) Q_5}$ , then  $Q_5$  is on, and the output voltage at this time is:

$$V_{OH} = V_{CC} - \frac{I_0 R_2}{h_{FE Q_4} h_{FE Q_5}} - \frac{V_{BE Q_5} (1 + h_{FE Q_5}) R_2}{h_{FE Q_4} h_{FE Q_5} R_6} - V_{BE Q_4} - V_{BE Q_5}$$

The DC noise immunity for this circuit is defined as follows:

**Positive Noise Immunity** =  $V_{IN(MAX, LOW LEVEL)} - V_{OL(MAX)}$  where  $V_{IN(MAX, LOW LEVEL)}$  at the input gives  $V_{OH(MIN)}$  at the output with  $I_0$  maximum.

**Negative Noise Immunity** =  $V_{OH(MIN)} - V_{IN(MIN, HIGH LEVEL)}$  where  $V_{IN(MIN, HIGH LEVEL)}$  at the input gives  $V_{OL(MAX)}$  at the output with  $I_0$  maximum.

The following worst-case values were determined for the basic gate circuit:

$$\begin{aligned} V_{IN(MAX, LOW LEVEL)} &= 850\text{mV} \\ V_{OL(MAX)} &= 350\text{mV} \\ V_{OH(MIN)} &= 2.6\text{V} \\ V_{IN(MIN, HIGH LEVEL)} &= 1.9\text{V} \end{aligned}$$

From the above values it is seen that  $PNI = 500\text{mV}$  and  $NNI = 700\text{mV}$ .

Defining AC noise immunity for the gate circuit is more complex. The most meaningful definition of AC noise is the

noise that will cause a flip-flop to latch. The method of measuring this noise is delineated in Figs. 2 and 3.

In the test circuit shown in Fig. 2b, gate B is a minimum turn-on delay limit unit. In Fig. 2a, the input pulse width and amplitude are varied until the flip-flop latches. The input is then measured to determine a point on the curve. Several units having different turn-off delays were used in the gate A position and a family of AC noise immunity curves were generated. It was observed that the curves moved to the left along the horizontal axis as a direct function of their measured turn-off delay. With this information and the minimum switching turn-off delay value, it was possible to limit the size of the "noise blocks" determined by crosstalk, reflections, and power distribution to values that would guarantee system operation under worst-case conditions. A similar method was used to determine the size of the blocks for a turn-on condition.

### Current spiking

When the output switches from a low to a high,  $Q_4$  and  $Q_5$  turn on faster than  $Q_3$  can turn off and a current spike appears on the  $V_{CC}$  line. Examination of the circuit shows that:

$$I_{CC(MAX)} = \frac{V_{CC} - V_{CE(SAT) Q_5} - V_{CE(SAT) Q_3}}{R_5}$$

The amplitude of this current spike depends on the value of  $R_5$  and is independent of loading. The very small saturation resistance of  $Q_3$  overrides any load resistance in parallel with it. The pulse width of  $I_{CC}$  is determined by several factors. First, pulse width varies as a function of load capacitance. Second, as the temperature increases, the  $h_{FE}$  of  $Q_3$  also increases causing it to turn-off slower; this increases the time that both  $Q_4$  and  $Q_5$  are on simultaneously. The current spike on the  $V_{CC}$  line is a major consideration in designing with TTL. Ground planes on the plug-ins and high frequency capacitors in the series 1600 controlled the effect of the current spike.

### A recent version of TTL

The circuit in Fig. 4 is a recently available version of TTL. The operation of this circuit is the same as those pre-

viously described except for the following:

On a rising input, the offset transistor,  $Q_6$ , remains off until its  $V_{BE}$  is overcome. When it turns on, the phase-splitter emitter will see an equivalent resistance of approximately  $570\Omega$  to ground.

Prior to the turn-on of  $Q_3$  or  $Q_6$ , there is essentially no current flowing in  $Q_2$ . This means that the collector node of  $Q_2$  and the output will be at a high potential until  $Q_3$  or  $Q_6$  turn-on. Then, the output changes rapidly (Fig. 5). When a resistor to ground is in the circuit, the collector of  $Q_2$  and the output change as shown in Fig. 5 (for standard TTL).

On a falling input,  $Q_2$  will remain in saturation until the potential at the emitter of  $Q_2$  falls below the  $V_{BE}$  drop of  $Q_3$  or  $Q_6$ ; at this time,  $Q_2$  has no path for emitter current and abruptly turns off. The collector of  $Q_2$  and the output node correspondingly rise to a high level.

The effects of this non-linear circuit in the emitter of  $Q_2$  are shown in the transfer characteristic in Fig. 5. It can be seen that the noise immunity of the circuit is improved. The purchase specification for the integrated circuit used in the series 1600 computer includes this new version of TTL.

### TTL trends

The series 1600 computer system TTL circuit is the standard Information Systems Division medium-speed integrated circuit. There are several recent developments that enhance the advantages of TTL, such as the many small arrays on the market that are TTL compatible. The wired OR function is being added to the family and is used where speed is not the primary consideration. The component price is such that it will be less expensive than DTL in the immediate future.<sup>2</sup> We feel the standard TTL is a very firm base from which to develop future computer circuit designs.

### References

1. Saenz, R. G., and Fulcher, E. M., "An Approach to Logic Circuit Noise Problems in Computer Design", this issue.
2. "Test Your IC IQ," Electronic Design, (Dec 1967).

# Installation of computers

**B. Aaront**

As RCA computer systems evolved from the small data processing unit to the large scale communications system, more efficient methods of installation, planning, and control were necessary. Previously the service manager who had a maximum of five or ten units to install could be on site as the equipment was being delivered. With large-scale communications systems having one or more computers, twenty or thirty tape stations, mass storage units, and multiple remote devices, it became apparent that this same manager could no longer operate intuitively. This paper emphasizes the growing need for formal planning and control techniques for the installation of RCA computers. It also documents the progress to date in applying these techniques.



**Bruce Aaront, Mgr.**  
Major Systems  
Information Systems Division  
Cherry Hill, N.J.

received the BA in Physics and Mathematics from New York University in 1950. He was employed as a Research Physicist in Electronics and Optics by the U.S. Government until 1952, at which time he joined RCA Service Company as Manager of the BIZMAC Computer Installation at ATAC in Detroit. In 1959 he returned to Cherry Hill as Manager of Field Support Engineering for Electronic Data Processing Services, and was responsible for installation of the first ten RCA 501 computers. He served in this position and subsequent positions as Manager of Project Control, Manager of Engineering and Training and Manager of Field Operations, until 1966 when he assumed his present position. Among his current duties is the management of the Field Service for Graphic Systems, Instructional Systems, Systems Centers, and Government Systems. Included in these responsibilities is the task of installing and maintaining the first computers of the new product lines.

**I**N THE COMPUTER INDUSTRY, competition has been increasing, profit margins have been shrinking, and it has become increasingly more difficult to obtain maintenance manpower.

Final manuscript received December 15, 1968.

Therefore, better methods to allocate our resources had to be devised. To accomplish this objective, a formal management control system was applied to the installation of major RCA computer systems. All resources available, such as manpower, material, time, money, and outside engineering assistance, would be catalogued and used as factors in the system. Restraints upon the project, such as installation due dates, system acceptance tests, customer needs, site facilitation, customer program implementation, and other factors would also be catalogued and used in the master project plan. Initial charting and planning techniques used were GANT charts, SHEWART charts, and an approach to PERT and critical path method.

## **SAMMS program**

One of the first systems to undergo this management planning was the SAMMS (standard automated material management systems) program. The master planning chart that evolved (Fig. 1), indicates that we used a combination of most of the presently accepted techniques. In retrospect we find a less than rigorous approach, in particular in the planning chart which does not conform to orthodox PERT or CPM planning. The planning combined both task and event orientation, and depended mainly upon event reporting. Basic tasks charted were:

- 1) Manpower training,
- 2) Manpower at manufacturing plant,
- 3) Design fabrication and system test schedule,
- 4) Equipment checkout at manufacturing plant,
- 5) Spare parts, test equipment and tools,
- 6) Engineering support, and
- 7) Environmental and site planning.

## **SAAMS manpower**

For each man assigned to the project a complete dossier was established, showing his education, present training and past job history. This was compiled into a continually expanding skills inventory. The skills inventory was used by project management as a guide to arriving at the appropriate timely decision. A major objective of our planning was to enable our management personnel to have all of the necessary information at their disposal to allow them to make these decisions at the decision points. Therefore, when a decision point was arrived at, management would have a concise listing of the objectives to be met, they would know what was required to meet the objectives, and would have the sum total of all the resources at their disposal.

## **Phase II**

Despite the departure from orthodox PERT and CPM planning techniques in the SAMMS installation, it was apparent the intensive planning and charting which occurred during this installation were in a large measure responsible for the successful completion of the installation. Therefore, work was started on more sophisticated and formal techniques of this type of planning. A new procedure for installation of major systems was embarked upon. This planning was to be based on task orientation and event reporting, with specific fall-back procedures at each critical juncture point.

The installation would be considered a closed system and careful planning and charting would be devoted to the following resources:

- 1) Manpower
- 2) Material
- 3) Time
- 4) Training

In addition, charting also included the following restraints:

- 1) Customer deadlines
- 2) Customer tests
- 3) Acceptance tests
- 4) Financial restraints

A diagrammatic approach of the arrow network type chart was decided upon, combining a modified PERT and a CPM technique. In addition, specific break points, dummy job lines, decision points, and alternate courses of action at the decision points would be inserted.

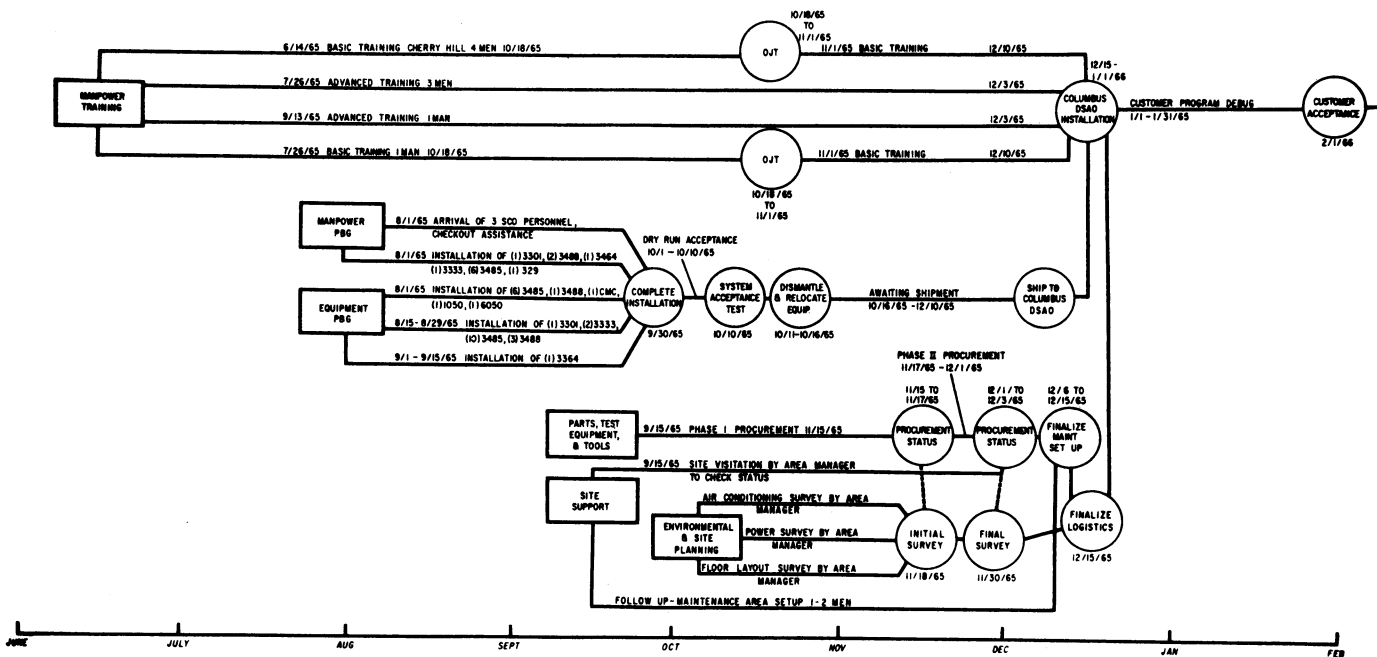

Fig. 1—Maintenance plan for the SAMMS program.

A fall-back plan was devised for each decision point. The plan included a complete list of all resources, both men and material, courses of alternate action, the effect upon the resources of each alternate course of action and the time frame within which the decision must be made.

#### Skills inventory

As a result of our SAMMS experience we expanded the skills inventory and insured it would be compiled for each major project. The skills inventory became a compilation of the individual and total manpower assigned to the project. For each man, a separate chart was prepared showing his past educational background, past experience, RCA experience and training, his present training, and his scheduled training. At any point in time, this skills inventory showed the total manpower resources available to the project manager.

#### Management information

Since it was essential to keep management completely informed as to the position of each particular project, each major Spectra installation was considered as a *separate* project. To provide the necessary information, the following items were charted:

- 1) Our objectives on a timely basis.
- 2) The men, material and other resources required.
- 3) Resources available.
- 4) The Decision Points at which alternate courses of action should or could be taken.

#### Installation diagram

The arrow network diagram was of prime importance in determining the proper work sequence in system checkout. It was essential that the model be one which could be related to the work on a one-for-one basis. In essence, this called for accurate timing of each task to be undertaken. Detailed analysis was made of each particular step of the installation. For example:

- 1) Initial pack of equipment at West Palm Beach and Camden, N.J.;
- 2) Deployment of key installation personnel and site representative;
- 3) Unloading from van;
- 4) Cartage to the site;
- 5) Physical installation at site;
- 6) Installation of power cables;
- 7) Installation of signal lines;
- 8) Preliminary checkout and debugging of equipment on a functional basis;
- 9) Running test and maintenance routines;
- 10) Running customer data; and
- 11) Running final acceptance test.

Each of these items was given a time cycle. In addition, time elements were applied to the sub-elements of the total job. For example, with respect to the checkout of the Processor, the sub-element time cycles were:

- 1) Installation of main racks;
- 2) Initial power-up test;
- 3) Installation of read only memory;
- 4) Basic time-cycle checkout;
- 5) Basic processor checkout;
- 6) Basic memory checkout;
- 7) Processor T&M checkout;
  - a) EO tests;
  - b) Buss-adder tests,
  - c) Fast memory tests,
  - d) Main memory tests,

- e) Snap shot and diagnose control,
- f) Staticizing,
- g) Exclusive functions, etc.
- 8) Checkout of monitor printer; and
- 9) Installation and checkout of special features.

The total grouping then, of sub-elements, elements, and major job cycles, gave the planner the total time necessary to complete the job and establish the break points. In addition, the scheduling criteria of each job was carefully examined. In particular, the necessity for start time was looked at very closely. A job was considered critical if the necessity for starting this particular job was tightly time oriented. If it was not time oriented, it was labeled a non-critical job. As in standard PERT and CPM planning, float and slack time determinations were made.

#### Additional advantages

Because of the necessity for careful analysis with respect to the planning itself, certain work that had been done in the past, always in a predetermined fashion by either habit or because it was "always done that way" was carefully analyzed. In some cases, it was found that the optimum sequence of work was other than it had been done in the past.

#### Specific applications

In late 1965, a letter of intent was given to RCA by the Department of Motor Vehicles of the State of California for a vast Computer Communications Network with an automatic realtime system. The system was to include a total



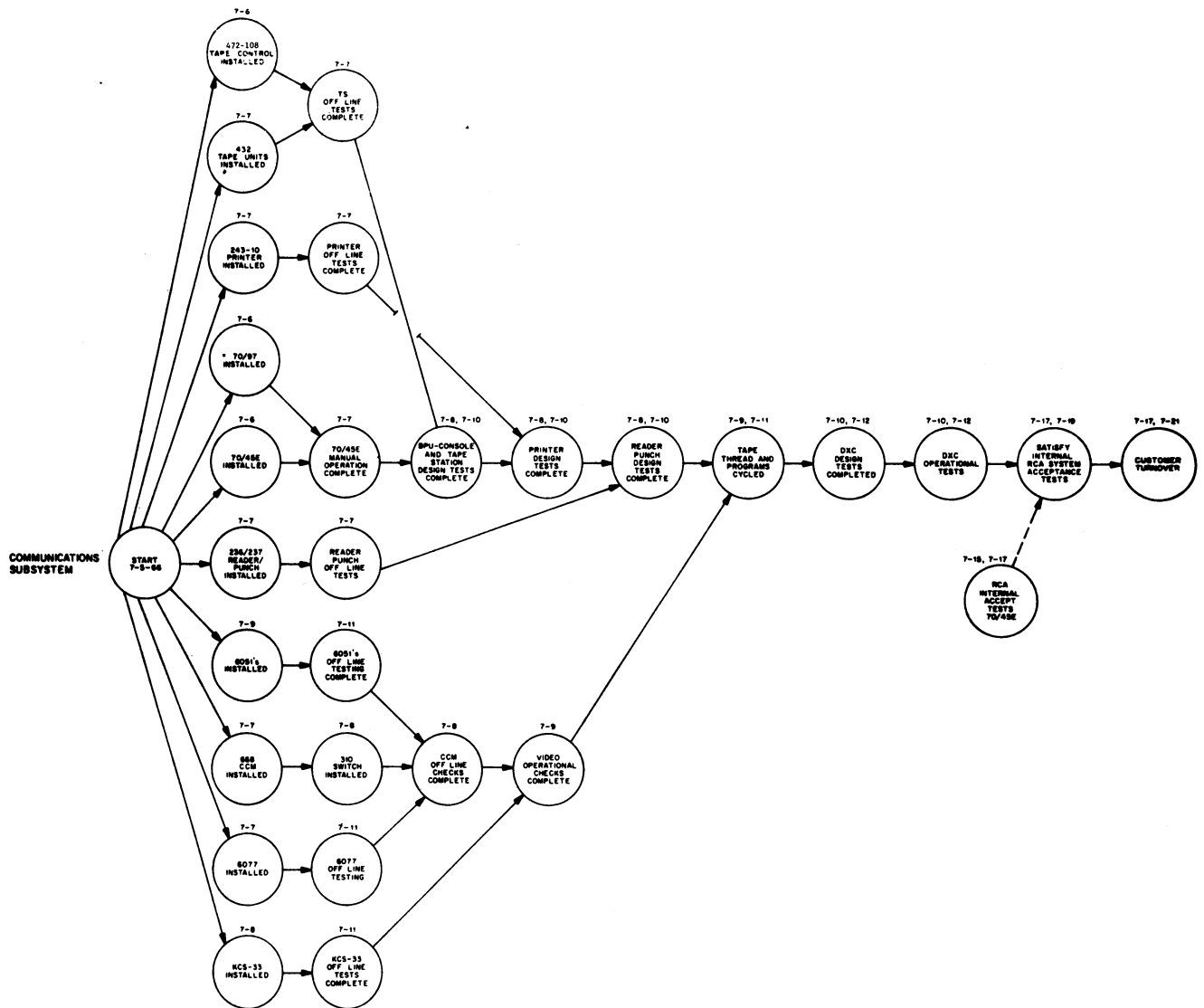

Fig. 2—Installation and checkout schedule for the California Department of Motor Vehicles system.

management information system, designed to be completely operational by 1970, with phase I implementation starting in 1965.

The main objectives of the system were:

- 1) Rapid service to California public;
- 2) Efficient, economic operation paced to rapid population growth;
- 3) Up to the minute information for the Department of Motor Vehicles (DMV) and related State and local activities;
- 4) Information for Management decision through a fully integrated management information system.

The system had to be capable of handling sixteen thousand transactions per peak hour and have an automated data bank located in Sacramento with storage capacity for over fifteen billion characters.

The DMV complex consisted of two separate systems: 1) a Spectra 70/45E data processing system with very large

mass-storage capability and 2) a very large Spectra 70/45G data communications system. Although each system was entirely separate, the installation, operation, and customer implementation had to be rigidly controlled so that both systems were operational at exactly the same time.

#### Planning

Detail charting and analysis of the project was started one year before installation. The planning and installation charts for the overall installation of the file control system and communication subsystem took the form of arrow diagrams and embodied most of the PERT and CPM techniques (Fig. 2). The arrow diagrams were task oriented with event milestones. Each event milestone showed both total starting or finish float. In addition, subcharts showed critical decision points, potential problem points, and points at

which fall-back procedures had to be invoked.

#### Job parameters

All planning must be congruent with the particular operation to be performed; therefore, prior to arriving at a final planning chart of the project itself it was necessary for management to decide the method of allocation of total resources. The basic resources available were men, material, money, and time.

In essence, three choices or modes of operation were open, they were:

- 1) Optimize both time and money—have an efficient and judicious distribution of men and material to obtain the maximum efficient output within an optimum time frame. This would not necessarily yield the minimum installation time.
- 2) Plan to have an installation completed with minimum money being spent. This would then give us unlimited use of time as a resource.

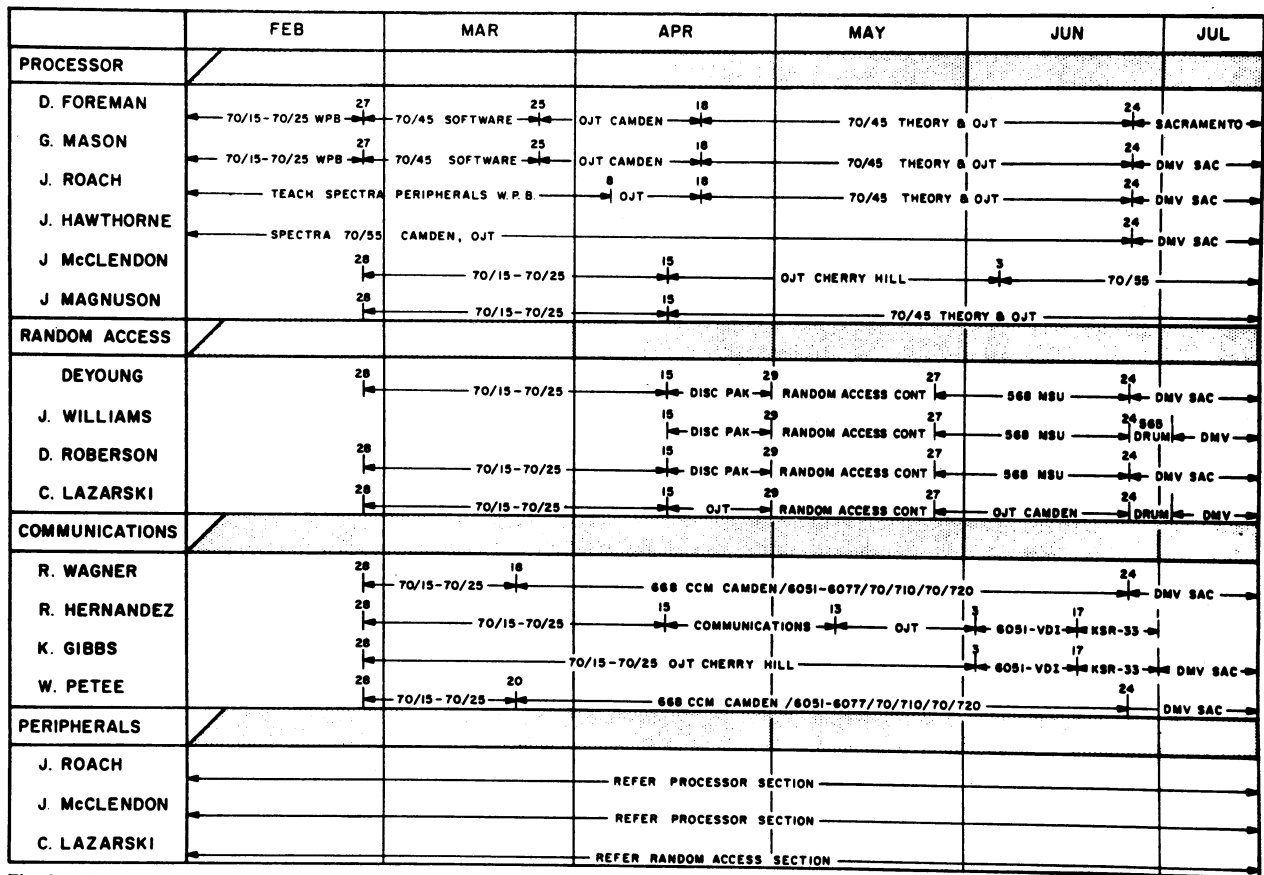

Fig. 3—Manpower training schedule for the Department of Motor Vehicles system.

3) Plan to have the installation completed in minimum time. This would allow the greatest use of manpower, material, and money.

Due to the critical nature of the installation with respect to the marketing of Spectra systems, it was decided that these systems should be installed in the minimum time. This minimum time interval was one that coincided with the needs of the State of California for implementation of its on-line communication system for both driver licenses and vehicle registration.

Planning was oriented to this mode of operation to achieve minimum installation time while still ensuring that it be done within reasonable financial bounds. It was mandatory that management be kept completely informed at all stages of the operation both on a technical and marketing basis. Accordingly, an event-oriented reporting procedure was established. This event orientation gave home office management bench marks in time, and in most cases these event-oriented points were also the critical or decision points.

#### Training

Sub-elements of the total system such as training, used a GANT chart method of presentation (Fig. 3). In essence,

the planning was handled on the main system installation chart, and the scheduling was handled on a sub-chart. The sub-chart deals with the training schedule, and shows the scheduling of the training for all of the men at the site. In particular, it indicates the high level of cross training given each man. Based on minimum installation time, the main planning document showed that to have a 90% chance of success at the decision points there had to be enough cross training in the skills inventory to allow for at least 20% attrition. To compensate additional men were trained for each particular piece of equipment. Each piece of equipment was covered by at least three fully trained men.

#### On-site application

Constant and careful surveillance of the critical path was provided by a rigid control system including a maintenance PERT diagram of all elements relating even indirectly to installation, training, and maintenance. Part of this control system was a complete weekly status report. In addition, a daily exception report was sent by TWX to the manager of major systems. As a result of the control system this resulted in operation of the Driver's License complex of equipment within a month after

delivery. Both the Spectra 70/45E and the 70/45G subsequently went to a 17 hour/day schedule and operated sometimes six and even seven days per week.

In three definitive cases, the operation did not meet a particular decision point. In these cases fall-back procedures were used, manpower scheduling was re-arranged and a *predetermined* plan of action was started. This was one of the greatest advantages of using formal planning techniques, that is, the problems were solved *before* they occurred.

#### Summary

It was apparent that the use of planning and control techniques increased efficiency, reduced the need for excess resource allocation, and increased customer satisfaction with the RCA product. These techniques, while sophisticated with respect to past installation techniques are gross and crude compared to approaches that can be used. A refinement of the above techniques took place with the installation of the Southern Bell Rate-Quote System, and further work is now taking place with the Field Engineering Department of Information Systems to provide a true PERT-CPM approach to computer installation.

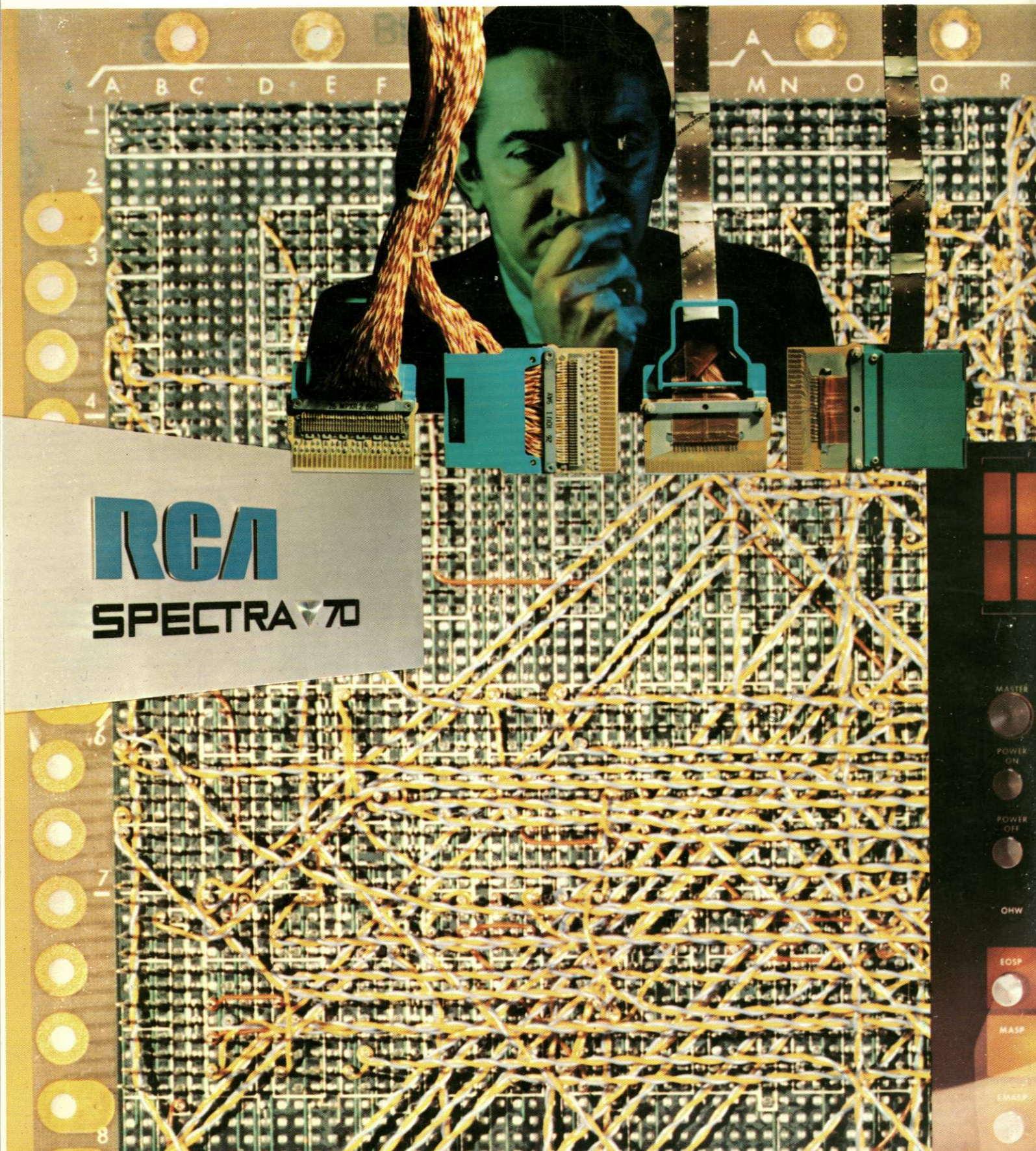

**RCA**  
**SPECTRA 70**

