

**MINDSET**

C A D D R A F T™

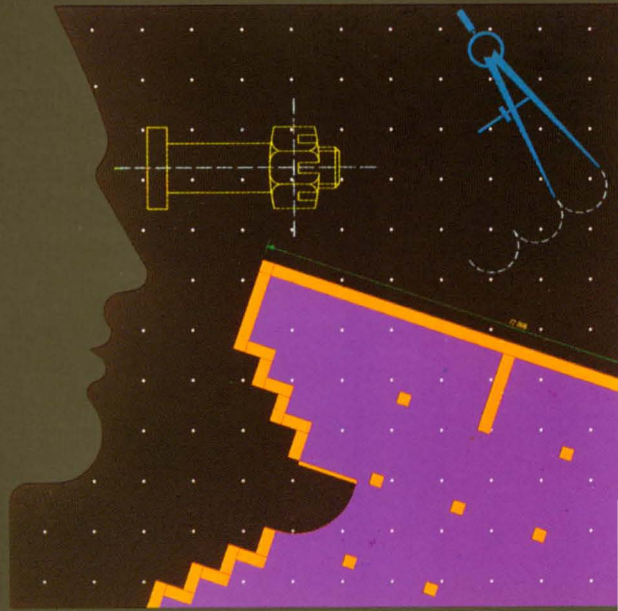

*User's  
Manual*

Information in this document is subject to change without notice and does not represent a commitment on the part of Mindset Corporation or Personal CAD Systems, Inc.

The software described in this document is furnished under a license agreement or non-disclosure agreement. The software may be used or copied only in accordance with the terms of the agreement.

MINDSET is a trademark of Mindset Corporation.

CADDRAFT is a trademark of Personal CAD Systems, Inc.

MS-DOS is a trademark of Microsoft Corporation.

Copyright © 1984, Mindset Corporation and Personal CAD Systems, Inc.  
All rights reserved.

Printed in U.S.A.

100521-001

# Contents

---

---

## CHAPTER 1

### Introduction

CAD and CADDRAFT	1-1
Designing with CADDRAFT	1-1
Easy to Learn and Use	1-2
How to Use this Manual	1-2

---

## CHAPTER 2

### CAD System Concepts

World Coordinate System	2-1
X and Y coordinates	2-2
Pixel Images	2-3
Database Units (DBUs)	2-3
Vertex Points	2-6
Digitize	2-7
Step Size	2-8
Rubberbanding	2-8
Grids	2-8
Layers	2-10
Symbols	2-11
Database Files	2-12

---

## CHAPTER 3

### Getting Started

Installing Your Mouse or Digitizer	3-1
Installing Your Printer	3-1
Installing Your Plotter	3-1
Loading CADDRAFT Into Your Computer	3-2

---

Help with the Operating System	3-2
Installing the CADDRAFT Program	3-2
Translation Program	3-3

---

## CHAPTER 4

### How to use CADDRAFT - A Brief Tutorial

Getting Started	4-2
Lesson One - Setting System and Job Parameters	4-3
Lesson Two - Simple Shapes	4-5
Lesson Three - Zoom and Pan	4-13
Lesson Four - Pan	4-15
Lesson Five - Changing Layers	4-16
Lesson Six - Move, Copy and Rotate	4-18
Lesson Seven - Delete	4-23
Lesson Eight - Save, Plot or Print	4-24
Lesson Nine - Load a File	4-29
Lesson Ten -Using Grid and View	4-30
Lesson Eleven - Symbols	4-32

---

## CHAPTER 5

Commands	5-1
----------	-----

---

### Section 1

Command Summary	5-3
-----------------	-----

---

### Section 2

DRAW Commands	5-9
ALIN (Any Line)	5-11
DLIN (Degree Line)	5-12
RECTangle	5-13
CIRCle	5-15
ARCS	5-17
ERASe	5-19
TEXT	5-20
WIDE	5-23

---

### Section 3

ZOOM Commands	5-27
---------------	------

---

ORGN (Origin)	5-28
WIN	5-29
IN or OUT	5-30
SIZE	5-32

---

<b>Section 4</b>	
PAN Command	5-35

---

<b>Section 5</b>	
GRID Commands	5-37
DISPlay	5-38
LOCK	5-39
SET	5-40

---

<b>Section 6</b>	
CHG (Change Layer or Data) Commands	5-41
WIN	5-43
IDEN	5-44

---

<b>Section 7</b>	
VIEW Commands	5-45
FIT	5-46
REDO	5-47
ALL and ACTV (Active Layer)	5-48
LAYer	5-49

---

<b>Section 8</b>	
MOVE Commands	5-51
WINdow	5-53
IDENtify	5-55

---

<b>Section 9</b>	
COPY Commands	5-57
MAKE SYM	5-59
WIN	5-61
IDEN	5-62

---

**Section 10**

EDIT Commands	5-65
ADDV (Add vertices)	5-66
MOVV (Move vertices)	5-67
DELV (Delete vertices)	5-68
BRK	5-69
MOVL (Move line)	5-70

---

**Section 11**

ROT(ate) Commands	5-71
WINdow	5-74
IDENtify	5-75
DEGRee	5-77

---

**Section 12**

SYMBOL Commands	5-79
DIR (Directory)	5-81
LOAD	5-83
LIST	5-85
PLAC	5-86
SAVE	5-87

---

**Section 13**

FILE Commands	5-89
DIRectory	5-90
LOAD	5-92
PACK	5-93
SAVE	5-94
BKUP (Backup)	5-95
ZAP	5-96
ERASe	5-97
QUIT	5-98

---

**Section 14**

PLOT Commands	5-99
PLOTter	101
PriNTEr	105

---

**Section 15**

DELEte Commands	5-109
-----------------	-------

---

UNDO	5-111
WINdow	5-112
IDENTify	5-113

---

**Section 16**

FIND Commands	5-115
DATA	5-116
DISTance	5-117

---

**Section 17**

INFO Page	5-119
Color or Monochrome	5-120
Active Layer	5-120
Display Ratio	5-121
Step Size	5-121
Database Units	5-121
Symbol	5-124
Default Drive	5-125
Plot from Comm Port	5-125
Active GRID	5-125
GRID (Displayed or Not)	5-125
GRID LOCK (On or Off)	5-126
Type of Input Device	5-126
Type of plotter	5-126
Plotter Default Drive	5-126
Cursor Definition	5-126
Text	5-127
Layer Information	5-128
Other Information	5-129

---

**Section 18**

Keyboard Commands	5-131
SYMBOL Conversion	5-133

---

**CHAPTER 6**

A DOS Primer	6-1
DOS Error Messages	6-7

---

## CHAPTER 7

### Hardware and Peripherals

Minimum System Requirements	7-1
Input Devices	7-1
Output Devices	7-2



# Chapter 1

---

## Introduction

# CAD and CADDRAFT

Computer-aided design is a technique for using a computer in creating, editing, and plotting designs. You enter your design into the computer's memory using a graphics tablet, or other digitizer.

Stored in the computer's memory as a series of X and Y coordinates, the design data can be easily and quickly edited, reducing the time required to make extensive design revisions.

The design data can also be plotted at any time on a high-speed pen plotter or graphics printer, producing accurate, high-quality plots in a fraction of the time it would take to draw them manually.

Until recently, CAD was possible only on large-scale mainframe and super-minicomputer systems. But with CADDRAFT from Personal CAD Systems, Inc., on your Mindset Computer you can enjoy virtually all the capabilities of large-scale CAD systems.

Created for two-dimensional design and drafting, CADDRAFT is already being used successfully by architects, engineers, designers, and draftsmen for a wide range of applications, including floor plans, tool design, mapping, and graphic documentation.

In addition, CADDRAFT allows you to transfer design file information to and from several industry-standard word processing and database programs. So using CADDRAFT along with the many application programs currently available for your Computer, you can now complete an entire design project--including word processing, financial and engineering analysis, and design--on one easy-to-use system while sitting at your own desk.

### Designing with CADDRAFT

CADDRAFT parallels the manual drafting process in many ways. To start a design, for example, you simply place a grid on your monitor screen, much as if you were using a quadrille paper tablet. You then create your design from a rich variety of graphic entities such as lines, circles, rectangles, arcs, symbols, and text.

Items to be used repetitively in a design can be drawn once, stored on diskette as symbols, and then placed automatically on your drawing as required. And if the specifications of a symbol change, you can make the required changes to the symbol on diskette, and automatically update your drawings with the revised symbol.

---

CADDRAFT's layering system is similar to standard overlay techniques such as pin registration, but more accurate. The system allows you to place design data or symbols on up to seven layers. So, you can place walls on layer 1, HVAC on layer 2, piping on layer 3, and so forth, and view each subsystem individually or in combination with other subsystems.

Depending on the scale you choose, you can create drawings up to 5,416 feet long, for example, with accuracy down to one inch. Whatever the scale, CADDRAFT allows you to scan your entire design on screen and to "zoom" in for greater definition. So you can work with great precision on exceptionally large and complex drawings.

When it comes to design revisions, CADDRAFT's range of functions enable you to respond to your client's whims quickly, easily, and with greater accuracy than is possible with manual drafting techniques.

## Easy to Learn and Use

Unlike many large-scale CAD systems, CADDRAFT is easy to learn and use. Typical users can begin to generate detailed designs within hours of starting on the system.

CADDRAFT commands--all readily understandable (DRAW, ROT)--are displayed on your screen. Once you select a command, the system displays several options for that command. Whenever you need additional information about a command or option, simply type a question mark and CADDRAFT displays helpful information right on your screen.

## How to Use This Manual

Your CADDRAFT User's Manual has been designed to serve both as a learning aid and as a reference book. The first section, "Getting Started," tells you how to set up your Mindset Computer System for using CADDRAFT and how to load CADDRAFT.

Once you're ready to start using CADDRAFT, it's recommended that you go through the next section, "How to Use CADDRAFT--A Brief Tutorial," for a "hands-on" introduction to the main functions and features of the system. Then you ought to be able to start your own design work with CADDRAFT, using the "reference" section of this manual, "CADDRAFT Commands," whenever you need step-by-step instructions for using a command or option.

Note: Don't forget that help is always available on your screen too, by pressing the ? key.

---

Finally, your CADDRAFT package includes a Quick Reference Guide that summarizes all the features of the system. As you become more proficient with CADDRAFT, the Quick Reference Guide may be all you'll need to guide you.

### **Help Is As Near As Your Phone**

If you're having a problem not covered in this User's Manual, or if you have suggestions for future enhancements, please call Personal CAD Systems at Nationwide (800) 882-7535. In California, call (800) 635-8306.

---

# CAD System Concepts

If you're a relative newcomer to CAD, there are several concepts used in computer-aided design that you should be familiar with before you start using CADDRAFT. The following topics are covered in this chapter.

World Coordinate System

X and Y coordinates

Pixel Images

Database Units (DBUs)

Vertex Points

Digitizing

Step Size

Rubberbanding

Grid

Input Layers

Symbols

Database Files

---

## World Coordinate System

The entire area available for you to draw on is your "world." World coordinates are the X and Y coordinates used to identify a specific point in this world.

With CADDRAFT, your world contains 65,535 world coordinates from top to bottom and 65,535 world coordinates from side to side. Since these coordinates are measured from the center (coordinates 0,0) you have . . .

+32,767 coordinates from center (0) to top

-32,768 coordinates from center (0) to bottom

+32,767 coordinates from center (0) to right edge

-32,768 coordinates from center (0) to left edge

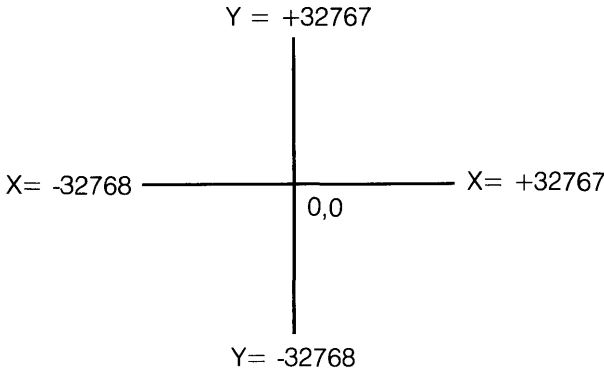

CADDRAFT always tells you where you are in the CADDRAFT "world."  
You'll see this at the bottom of your screen:

**-302**

X coordinate

**+ 85**

Y coordinate

These coordinates can be positive (+) or negative (-), depending on their world position.

---

## X and Y Coordinates

You find your way around your CADDRAFT world with X (horizontal) and Y (vertical) coordinates – much as you find a street location on a city map that has letters across the top and numbers down the side.

Although the number of world coordinates (65,535) does not change, your available drawing area will seem to shrink or expand according to the relationship you establish between the world coordinates and your database units. If you were working in feet and inches, with the smallest degree of accuracy set at 1 inch, your total drawing area would be 65,535 inches, or a little over a mile square.

---

## Pixel Images

A pixel, or “picture element,” is the smallest element you can use when designing on your screen.

The clarity, or resolution, of your screen image is measured in terms of the number of pixels in the X (horizontal) and Y (vertical) directions. For example, a 32 by 20 pixel image wouldn't be as clear as a 320 by 200 pixel image.

The resolution of the monitor you're using determines how accurately your CADDRAFT designs will be displayed on the screen. For instance, a square may appear to be rectangular, though when the square object is plotted, it will be accurately plotted as a square.

Resolution is a matter only of screen clarity. The clarity and precision of your finished drawings will depend on the type of printer or plotter you're using.

---

## Database Units (DBUs)

Database Units, or DBUs, are the smallest units of distance in a CADDRAFT drawing.

CADDRAFT allows you to define the Database Units for your designs. You can tailor DBUs for unit designations – for example, in, inch, INCH, ft., foot, FT., and so forth.

You can also tailor DBUs for the smallest degree of accuracy (in fractions or decimals) that you want. If you're an architect, you'll probably work most often in feet and inches. If you're a mechanical engineer, you may want to design in tenths of an inch or centimeters. You can decide whether you want your drawings to be accurate to one inch, 1/4 inch, 1/8 inch, and so on. If you're an engineer, you may want your drawings to be accurate to one thousandth of an inch. CADDRAFT lets you decide.

---

See the section on Database Units under INFO in Chapter 5 for more information on setting Database Units.

## DBUs for Drawing Scale

Using Database Units, you can draw a design for a circuit board that's accurate to one thousandth of an inch or create a floor plan that's accurate to one inch. In other words, both the maximum size of a design and its accuracy are determined by the Database Units you choose.

So it's important, when you're determining what DBUs to use, to visualize the smallest distance that you're likely to use in your design. If you choose 1 DBU = 1 inch, you'll be able to draw a structure that's 65,535 inches long (5,461 feet), and your drawing will be accurate to one inch. But you won't be able to show any object in fractions of an inch.

## DBUs While Drawing

CADDRAFT automatically measures the objects you draw while you're drawing. The measurements appear at the bottom of your screen in the Database units you've selected.

For instance, if you've chosen feet and inches, accurate to 1 inch, to draw a wall elevation, you might see something like this at the bottom of your screen:

120	7Ft. 2In.
(The angle)	(The measurement)

You see the same information when you use the FIND/DIST command.

## DBUs and Symbols

Symbols are very useful whenever an item is to be repeated in a design, or needed in more than one design. Anything that can be drawn can be made into a symbol and saved in a symbol "library."

---

For more efficient drawing, you'll probably want to store your symbols in DBUs that are consistent with the type of design they'll most often be used in. For instance, architectural symbols should probably be stored in DBUs of 1/4 or 1/8 inch, and engineering symbols in tenths or mils.

Sometimes, you'll want to use symbols in a drawing that you've created using different DBUs. If a symbol and a drawing use inconsistent DBUs, you'll see this prompt.

SYMBOL USES DBU # \_\_\_\_\_ ACTIVE SYMB is - CONTINUE Y/N

## DBUs and Text

CADDRAFT allows you to define the size of the text you use in your drawings. Text is stored and recalled in DBUs. This CADDRAFT function must be handled carefully.

When using the TEXT command, you need to keep track of two numbers:

1) the number the TEXT is stored under, and 2) the size, in DBUs, that you've assigned to each number.

For instance, TEXT 1 might be 6 DBUs (high), TEXT 2 might be 15 DBUs and TEXT 3 might be 32 DBUs. The higher the DBU number, the larger the TEXT.

The size of Text in relation to your drawing is a function of the DBUs established for the drawing. For instance, if your DBU is one inch, and the TEXT you use is set at 6 DBUs, the TEXT will show as 6 inches high in relationship to the drawing.

Keep in mind that if you change the size of a TEXT number, all text of that number will be changed. In other words, if you've been drawing with TEXT #4 set at 8 DBUs and decide to change TEXT #4 to 12 DBUs midway through the drawing or after the drawing is complete, all Text created with #4 will become 12 DBUs high.

See INFO and DRAW/TEXT in Chapter 5 for more information on TEXT.



## DBUs and Pixels

Database Units and pixels are closely related in CADDRAFT. Their relationship is shown in the DISPLAY RATIO in the INFO page. Briefly, at a 1 to 1 ratio, one pixel represents one DBU. With 2 to 1 ratio, two pixels equal one DBU.

As you use commands such as ZOOM to change the size of a drawing on your screen, one pixel may represent many DBUs; it's also possible for one DBU to encompass multiple pixels.

See the INFO section in Chapter 5 for more information on display ratio.

## Vertex (Vertices) Points

A vertex is any X, Y coordinate point in your design. So every design element is represented by a unique combination of vertices. For instance, the vertices of a straight line are it's beginning and end points. The vertices of a rectangle are the corners, and the vertices of a circle are its center and radius.

Although you may see a drawing like this . . .

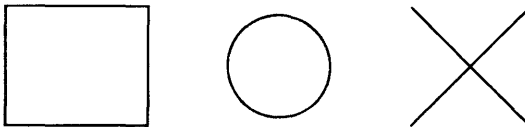

### ELEVATIONS

. . . all CADDRAFT sees is this:



---

In other words, CADDRAFT stores and sees only the vertices.

If vertex points are connected, like this . . .

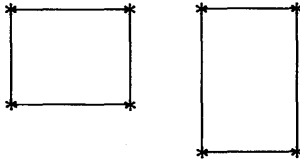

. . . CADDRAFT sees a single design element which can be MOVEd, COPYed, ROTated, and so forth.

But if CADDRAFT sees a design element with disconnected vertex points, like this . . .

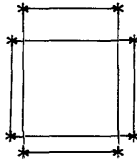

. . . CADDRAFT treats is as several design elements that will have to be WINdowed or linked as an IDENTified group in order to be MOVEd, COPYed, and so forth.

---

## Digitize

To digitize with CADDRAFT is to create vertex points using your mouse, graphics tablet, or keyboard. In other words, you choose the key points, and CADDRAFT does the drawing.

---

## Step Size

Step size is the distance the cursor will move on your screen, in DBUs, when you use your keyboard cursor control keys.

Step size depends also on the relationship between DBUs and pixels. For instance, at a Display Ratio of 1 pixel per 1 DBU, a step size of 6 would move the cursor 6 pixels per press of a cursor control key. At a display ratio of 2 pixels per 1 DBU (Display Ratio = 2), a step size of 6 would move the cursor 12 pixels per press of a cursor control key. When you're zoomed way out, it is possible to press the cursor control key many times, each time moving within the world but without moving from a pixel.

---

## Rubberbanding

"Rubberbanding" is a technique of moving vertex points around the screen before making a final decision on their placement.

Rubberbanding is possible with all the shapes in the DRAW menu.

---

## Grids

The use of GRID enables you to enter design data quickly and with more accuracy.

Grid will be familiar to you, of course, if you've ever used grid paper as an aid in drawing. With CADDRAFT, dots on your screen represent the intersection of lines on grid paper. The dots can be any size you choose.

---

The distance between grid points can be different on the X and the Y axes (see “X and Y coordinates” in this chapter).

Ten grid sizes can be preset or changed through the INFO Command. These sizes can then be selected for use through the GRID command on the main menu, you can easily change grids while drawing for greater or less detail.

Grid sizes are set in Database Units. A 12 by 12 grid would be 12 DBUs in the X direction and 12 DBUs in the Y direction. If your DBUs were set to feet and inches with 1 inch as the smallest degree of accuracy, this grid would represent 1 foot in either direction. If your smallest degree of accuracy were 1/2 inch the grid would be 6 inches in either direction.

To check for information on the active Grid and size, press **CTRL G**.

## Grid Locking

Grid Lock is a feature of CADDRAFT that assures drawing accuracy. It is “toggled,” or turned on and off, from the keyboard. At the bottom of the screen, a **G** appears when this feature is on. Design elements that you create on the screen will “snap” to grid points.

## Layers

Layers are analogous to transparent overlays on a drawing. In a floor plan, for example, the walls could be on layer 1, wiring could be on layer 2, and plumbing on layer 3. The layers of data can be displayed and plotted individually or in any combination with each other.

Layers can be differentiated by using different line types (solid, dotted, dashed, dash-dot) and, on systems that use color, by using different colors.

When plotting a design with a color plotter, you can assign any pen color to any layer.

This is what the layer page on the INFO menu looks like:

#	Type	% Pen	Info
[ 1	————	0	1
2	-----	0	2
3	.....	0	3
4	- . - .	0	4
5	————	0	5
6	-----	0	6
7	.....	0	7

Viewed layers are blocked  
 BUTTON #1 - select; BUTTON #2 - return to INFO menu

If this page were in color, the layers would be different colors. The line type on the screen represents the line type of the layer. The INFO heading means that you can assign an eight character (or less) description to each layer, for reference purposes.

---

The layers here are set for different colors, types, and relationship to plotter pens.

Layers require some planning. For instance, symbols can be created using several layers, then placed on other layers. It's a good idea to plan your designs so that items to be shown separately are on different layers.

Layer information is set through commands in the INFO menu and displayed through commands in the VIEW/LAY menu option. See Chapter 5 for more information.

---

## Symbols

Symbols can be used whenever an item is to be repeated in a design or is needed in more than one design. Anything that can be drawn can be made into a symbol and saved in a symbol "library."

For example, symbols can be saved for items of furniture (chair, desk, credenza) for interior design purposes, or for architectural symbols (sink, door, electrical outlets).

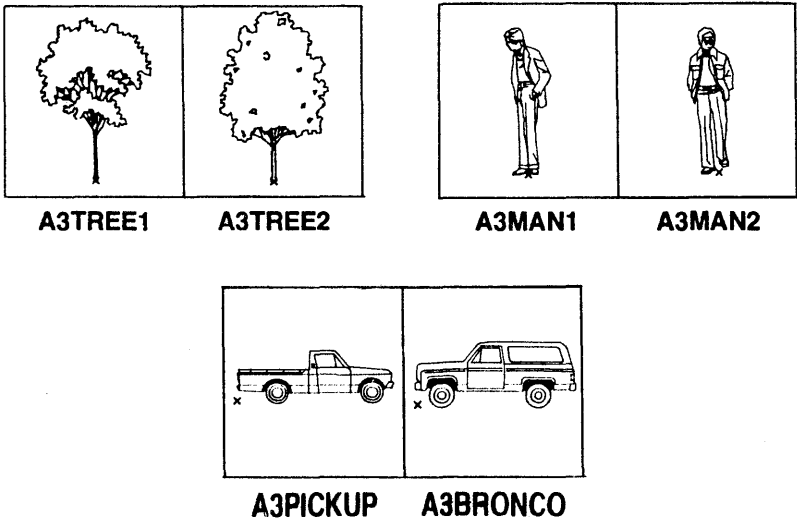

---

Symbols can be created from several different layers – for example, when you're using several colors in a symbol. A symbol can be placed on any layer, including the one it was created on.

You need to think ahead when storing symbols. See the SYMbol section in Chapter 5 for information on storing and displaying symbols in relationship to layers.

Frequent use of symbols will increase your efficiency and require less computer memory than drawing the same item several times. Symbols may be MOVEd, ROTated, COPIed, and EDITed to make new symbols.

Symbols are stored and placed through the SYM or COPY commands in the main menu.

---

## Database Files

A Database File is a design created on your computer and stored on a floppy diskette. It is typically stored on the default drive selected in #8 on the INFO page (described in the INFO section under Commands in this manual). To store a design as a Database File, you must assign it a unique name of up to eight characters.

When you examine your directory of files, you'll see that the extension .DBF has been automatically attached to your Database File names.

# Chapter 3

---

## Getting Started

Your CADDRAFT system includes five diskettes, this Users' Manual, and a Quick Reference Guide.

To run CADDRAFT, your Mindset Computer System must be equipped with at least 256K RAM, 2 320K disk drives, a monitor (color optional), and a cursor control device (mouse or digitizer). In addition, you'll need a plotter or printer to create hard copy output of your CADDRAFT designs.

Before loading CADDRAFT, make sure that your mouse or digitizer and plotter or printer are properly installed.

---

### Installing Your Mouse or Digitizer

Install your mouse or digitizer according to the instructions provided by the manufacturer. The proper DIP switch settings and cable configuration for several input devices can be found in Chapter 7. These should be checked as part of the installation procedure. If you have the Mindset Mouse, attach it to the right side of your keyboard and read the instruction guide.

---

### Installing Your Printer

If you have a graphics printer connect it to your Computer through a parallel port.

If your printer is an Okidata, you must install the Plug and Play option in order to have graphics printed on the printer.

See Chapter 7, Hardware and Peripherals for a description of switch settings for some printers.

---

### Installing Your Plotter

If you have only one RS-232C module which is used for your mouse or other input device, your plotter will have to share this port. This can be done by manually disconnecting your input device when you are ready



---

to plot and connecting your plotter to COMM.1. You will be prompted when it is time to do this.

DIP switch settings and cable configurations can be found in Chapter 7. These should be checked as part of the installation procedure.

---

## Loading CADDRAFT

Your CADDRAFT system includes the following diskettes:

Diskette	Contents
System Diskette A	CADDRAFT system
System Diskette B	CADDRAFT System
HELP Files On-line	HELP information on commands
Plotter Interfaces	Files to interface plotters to CADDRAFT
Sample Files	Sample drawings

---

## Help with the Operating System

Before starting to use CADDRAFT you will want to copy COMMAND.COM to your CADDRAFT SYSTEM A and SYSTEM B DISKETTES. If you are not familiar with the Operating System (DOS) commands that will enable you to copy and transfer files on these diskettes, please refer to the DOS Primer in Chapter 6.

---

## Installing the CADDRAFT Program.

When installing your CADDRAFT program using the following directions, remember the A: Drive is the one on the left and Drive B: is the one on the right for a two floppy system. Also, the words disk and diskette are used interchangeably. When you are required to type in a number from

---

the keyboard, do not use the 10 key pad, use the numbers at the top of the keyboard.

To load CADDRAFT into your computer, follow these steps:

1. Load DOS first

Because CADDRAFT is not a system disk, you must use your standard DOS disk to "boot" your system. Place your DOS diskette in drive A (the one on the left) and turn on the computer. If your computer is already on, place the DOS diskette in drive A and press ALT and RESET simultaneously.

NOTE: If you haven't already done so, you should format at least one blank double-sided, double-density diskette--for storing your CADDRAFT files--before going from DOS to CADDRAFT. See "A DOS Primer" in this manual for instructions.

2. When the **A>** prompt appears, type **B:** and press (Return) This selects drive B as the default drive of your system--the disk drive to be accessed to load or save CADDRAFT files.

3. Place the CADDRAFT System A diskette in disk drive A and the System B diskette drive B. Type **CDTWO**.

4. When this message appears at the bottom of the CADDRAFT title page--

Press Any Key

Press any key.

5. When prompted to do so, remove the System B diskette, put it back in its protective sleeve and return it to a safe place.

As you use the program, you'll have to insert other CADDRAFT diskettes, and your own formatted diskettes for file storage, in drive B. The program prompts you whenever you need to change diskettes.

---

## Translation Program

If you are upgrading your software from an earlier release of CADDRAFT (1.30 or 1.35), you will need to translate your files to 1.40 format. This is done with the translation program, CPTRANS, found on your SYSTEM B disk.

---

After you have "booted" DOS, according to the directions in the previous section, you can translate your files. It is recommended that you make a copy of your files using the DOS COPY Command and translate the copy, instead of the original files.

With a two floppy disk drive system, place your SYSTEM B disk in Drive A and your Files to be translated in Drive B.

When you see the prompt, A> Type:

**CPTRANS** press (Return)

You will see this information:

On which disk drive do Files and symbols reside? (A,B,C,D,E,F, or G)  
Enter the proper drive letter; no (Return) is necessary.

This program translates 1.30 and 1.35 File and Symbol databases to 1.40 format.

You will then see:

Translate a (F)ile or (S)ymbol, (E)xit, (C)hange Drive? (Enter F, S, E or C)

Enter **F**, **S**, **E** or **C**. If your Database Files contain Symbols, choose the **F** option exclusively. The Symbols will be translated automatically with the File. If you do not choose this option, you will have to translate the Symbols one by one.

You will then be prompted:

Enter name of file (.DBF) to be translated:

Enter the name of your file. You will be prompted:

Enter new name or (CR) for existing name:

---

You can rename your file at this point. If you wish to use the same name, press (Return). There is no option to rename symbols.

You will see:

Your file.DBF uses the above symbols - do you wish to translate all?  
(Y or N).

This is your only opportunity to automatically translate all Symbols used by your Database File. Answering (Y)es is strongly recommended.

CADDRAFT will automatically reformat the files to 1.40 format. When the file is translated you will see:

Translate another file? (Y or N)

You may now exit the program or translate another file.

## Chapter 4

---

# How to use CADDRAFT- A Brief Tutorial

This tutorial consists of a series of exercises which will help you learn CADDRAFT in a systematic way.

Before you begin this tutorial you should read the manufacturers' instructions for your computer and plotter or printer to be sure you have installed all components correctly.

You should also have read the section on System Configuration to be sure that you have adequate memory, disk drive capacity, and add-ons to operate this software.

Remember, your CADDRAFT diskette is not a MS-DOS system diskette and that you will have to boot the system with a system diskette before inserting the CADDRAFT diskette. If these terms are unfamiliar to you, refer to your owner's manual for your computer.

## Getting Started

After you turn your system on, your screen will look like this:

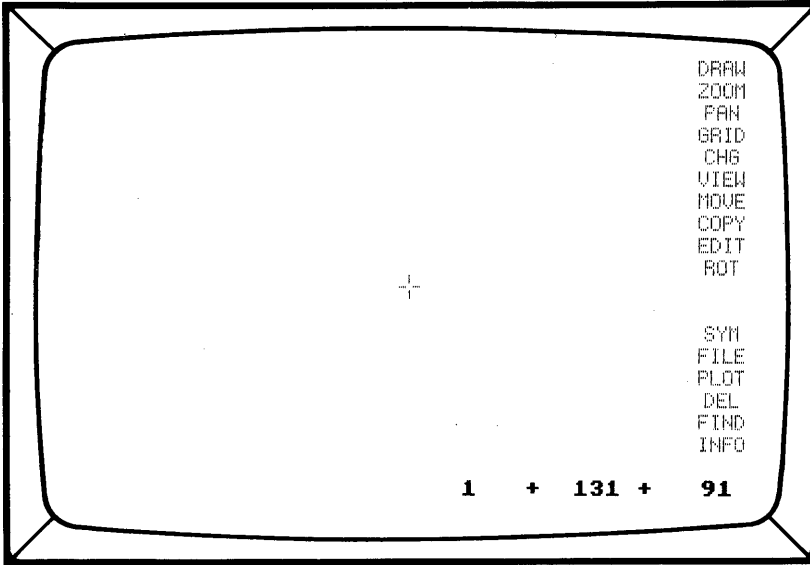

There are 16 commands in the MAIN MENU on the right of your screen.

To select a command, use your mouse to move the cursor to the command you want, then press the #1 Button. When a menu item is engaged, a submenu will appear with additional options.

To release or abort a command, press the #2 Button, the ESC key or (Return) key on your keyboard.

Throughout this tutorial, it's assumed that you're using a mouse. Button #1 refers to the left Button on the mouse. Button #2 will refer to the right or center Button.

The symbol that appears on the screen for either the mouse or the keyboard command will be called the cursor.

## Help Information

For onscreen HELP on any command, after selecting the command press ? and (Return).

# Lesson One

## Setting System and Job Parameters

The INFO command allows you to customize CADDRAFT for the output device (plotter or printer) that you are using and preset some of the CADDRAFT features such as grid size, size of text, line types, and so forth.

### PROCEDURE: Set Parameters

To customize the INFO menu for your monitor and output device, follow these steps:

1. Move the cursor to INFO, press Button #1. An information screen appears:

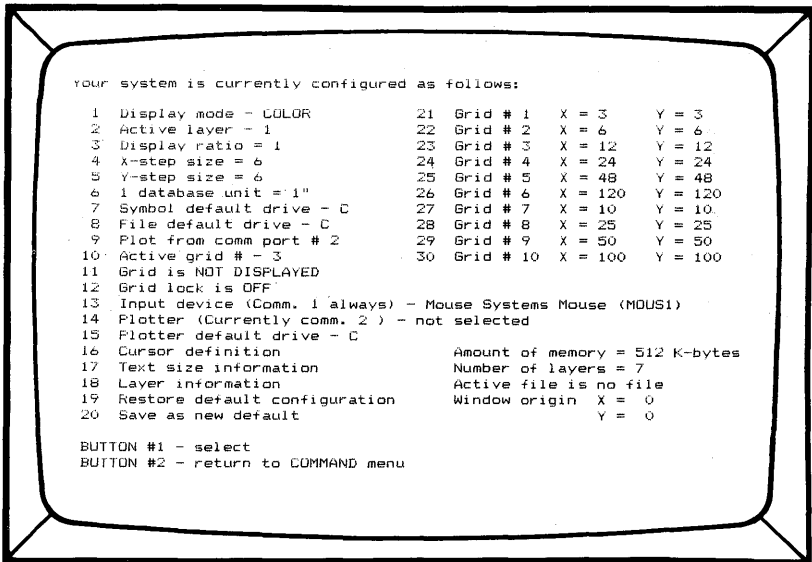

2. Set the parameters you want by moving the cursor to the parameter number and pressing Button #1. For instance, to select COLOR or MONOCHROME, move to #1 on the INFO menu and press Button #1. Then move the cursor to COLOR or MONOCHROME, press Button #1 again.

3. All parameters are set in a similar manner. You choose a number, press Button #1, then follow the prompts.

---

You can either return to the drawing area or make a new default INFO page by following 4. or 5. below.

4. To return back to the drawing area press Button #2 on your mouse.

5. To create new default parameters, (the default parameters are those that are used when starting up the system), move to #20 on the menu and press Button #1. At the prompt, "are you sure? NO YES", select YES by pressing **Y**. Press Button #2 on your mouse to return to the drawing area.



# Lesson Two

## Simple Shapes

CADDRAFT is designed for freehand drawing as well as precise technical drawing. This lesson shows you how to draw simple shapes that do not require precise dimensions, using the DRAW command and the options in the DRAW submenu. These are:

ALIN = Any line  
 DLIN = Degree line  
 RECT = Rectangle  
 CIRC = Circle  
 ARCS = Arcs  
 ERAS = Erase last entry  
 TEXT = Text  
 WIDE = Wide lines

### PROCEDURE: Draw Straight Lines

1. Position the cursor over DRAW and press Button #1. The submenu commands appear and your screen now looks like this:

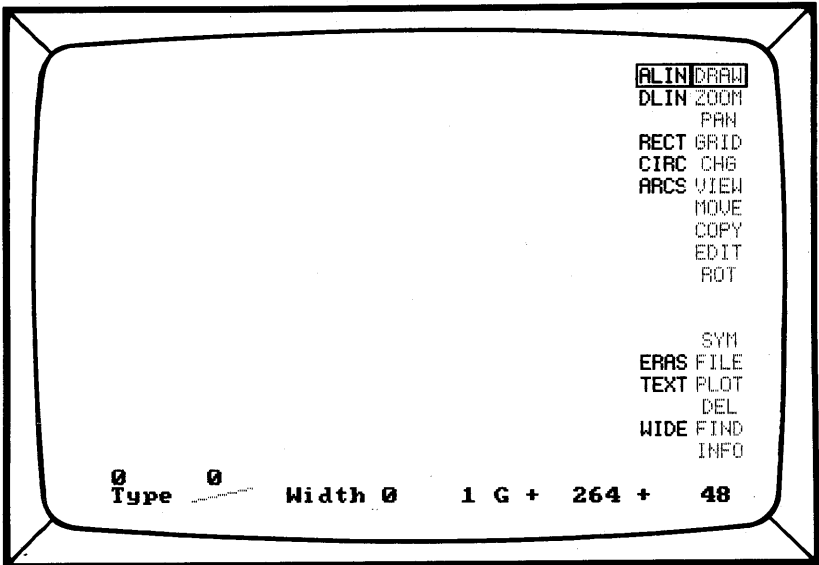

2. Move your cursor to the drawing area. Notice how the world coordinates at the bottom right of your screen change as the cursor moves.
3. Move the cursor to the place on the screen where you want to start the line. Press Button #1.
4. Move the cursor to the place on the screen where you want the line to end and press Button #1 again. Notice the "rubberbanding" of the line as you move the cursor around.
5. If you want to release the line and pick it up on another part of the drawing surface, press Button #2.

Your screen should look like this:

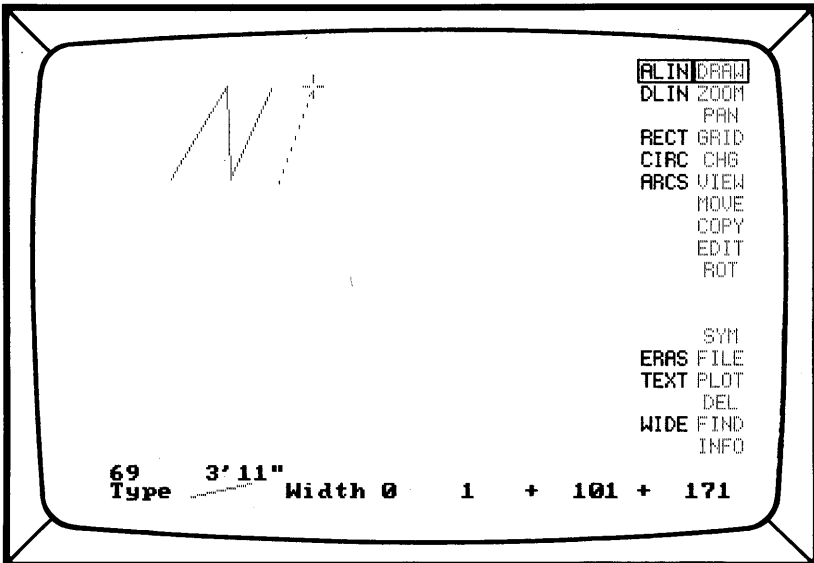

If your lines look different, don't worry. But try to leave room to draw five more shapes.

---

**PROCEDURE: Draw a Triangle**

1. Move the cursor to DLIN and press Button #1.
2. Move the cursor to the drawing area, position it where you like, and press Button #1.
3. Move the cursor and press Button #1, then repeat. Notice the "rubberbanding" as you move around the drawing area.

Your screen should look like this:

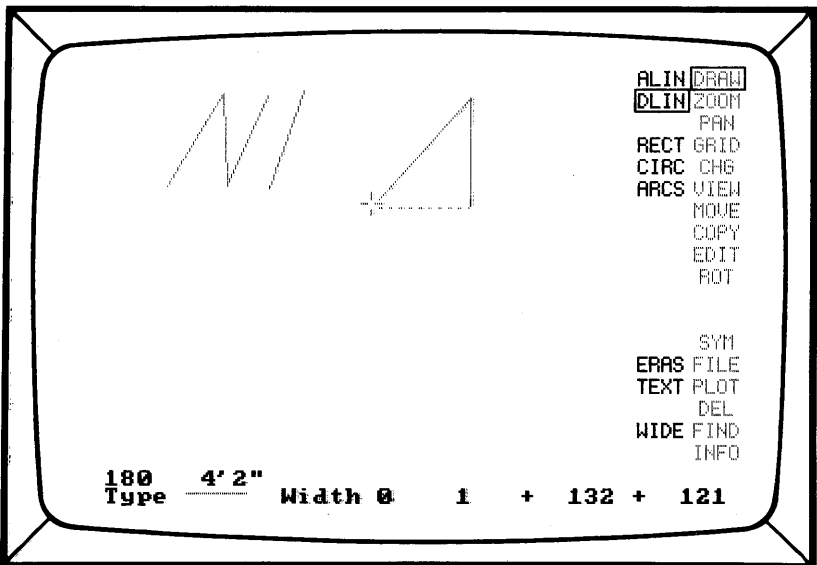

## PROCEDURE: Draw a Rectangle

1. Move the cursor to RECT and press Button #1.
2. Move the cursor into the drawing area and position it where you want the lower left corner of the rectangle to be, then press Button #1.
3. Move the cursor where you want the upper right corner and press Button #1. Notice the "rubberbanding" as you move the cursor, and that the broken lines become solid when you "set" the upper right corner.

Your screen should now look something like this:

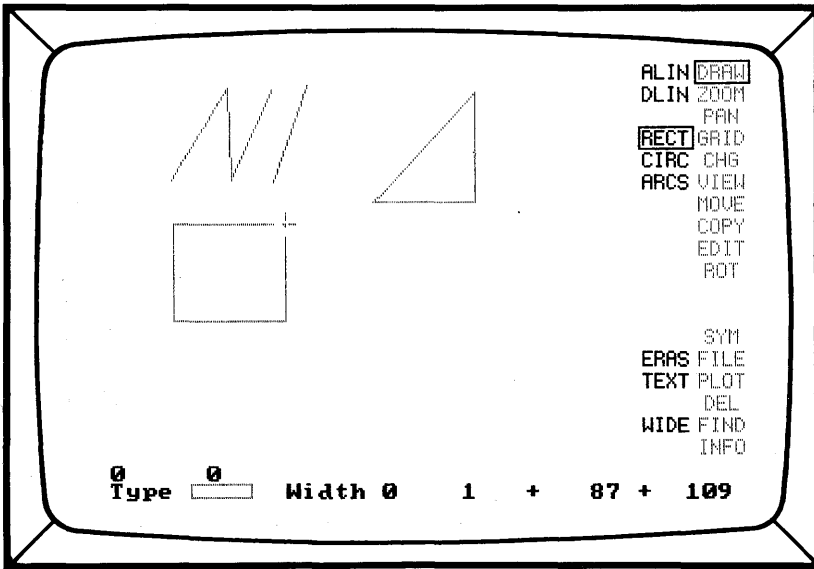

---

**PROCEDURE: Draw a Circle**

1. Move the cursor to CIRC and press Button #1.
2. Move the cursor into the drawing area, choose a position for the center of the circle and press Button #1.
3. Move the cursor away from the center point and position it where you want the circumference of the circle; then press Button #1.

Your screen should now look something like this:

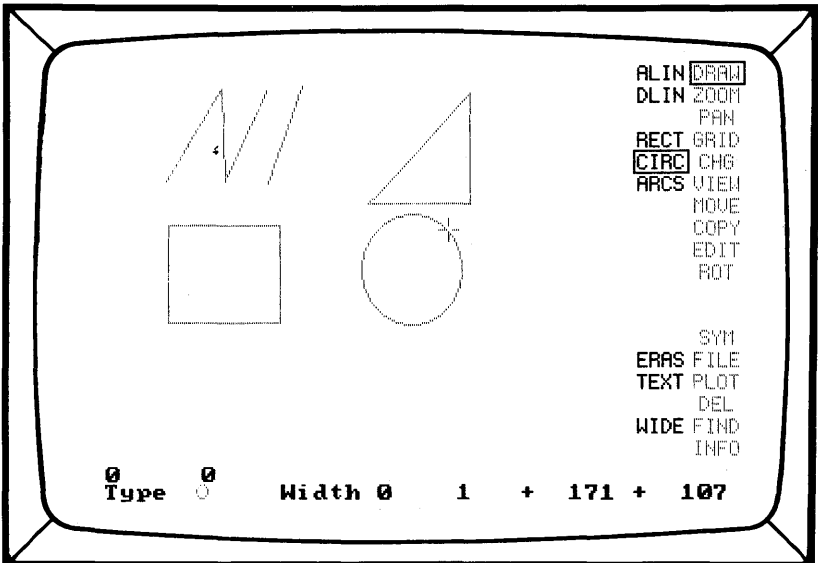

---

**PROCEDURE: Draw an Arc**

There are two methods of drawing arcs, the THREE- POINT method and the CENTER POINT/RADIUS method.

**CENTER POINT/RADIUS method:**

With this method, you first define a circle, then specify a segment of its circumference as your arc.

1. Move the cursor to ARC and press Button #1.
2. Move the cursor into the drawing area. Press Button #1 to set the center point of the circle.
3. Move the cursor to where you want the circumference of the circle--and the starting point of your arc--and press Button #1. A circle of broken lines appears.
4. By moving the cursor counterclockwise around the circle, you define your arc. You can also move the cursor clockwise to define the part of the circle you don't want as part of the arc. When it looks right, press Button #1.

**THREE POINT method (for ARCs and CIRCles):**

This method allows for more accuracy in positioning your arcs.

1. Move the cursor to ARC and press Button #1, then press the **3** key on your keyboard.
2. Move the cursor into the drawing area and select the two end points of the arc.
3. Now, by "dragging" the cursor around the screen, you can adjust the curve of the arc.
4. When the desired adjustments are made, press Button #1 to place the arc.

To abort a three-point arc operation, press Button #2.

Your screen should now look something like this:

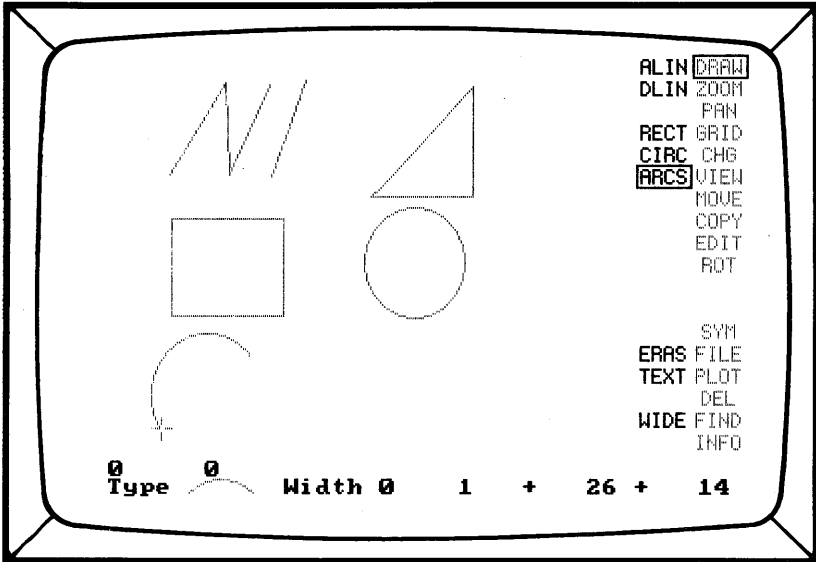

### PROCEDURE: Write Text

1. Move the cursor to TEXT and press Button #1.
2. Move the cursor into the drawing area and position it where you want to place your text, then press Button #1. The following prompt appears:

Move cursor to location for 1st letter, then Btn 1

3. Type in your text and press (Return).

You can use the BACK SPACE key to erase or ESC to cancel your command altogether.

Your screen should now resemble this:

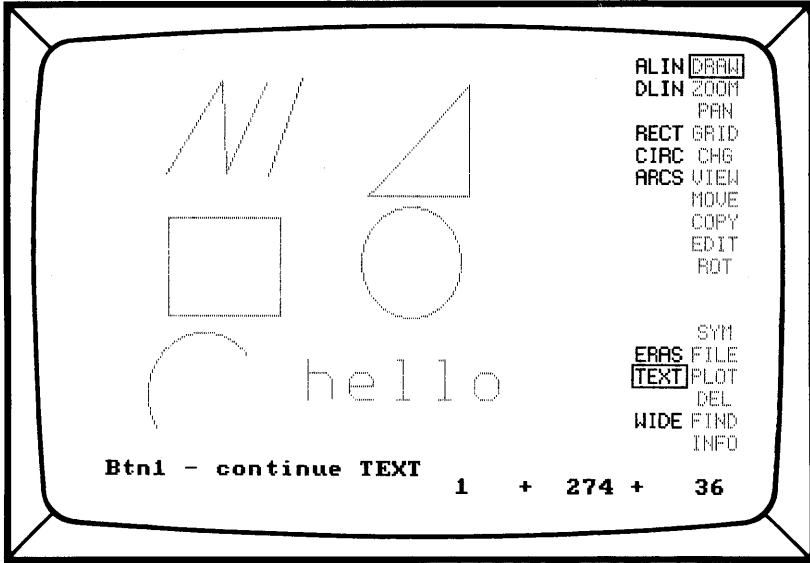

You've now practiced drawing the basic shapes with which you can design anything you can draw on paper. Leave your drawings and text on the screen to work with in the following lesson.



# Lesson Three

## ZOOM and PAN

The ZOOM command makes your design larger or smaller; it works much like the zoom lens on a camera.

The PAN command allows you to move, or scroll around the screen to work on different portions of the drawing area.

### PROCEDURE: ZOOM

1. To reduce the size of the shapes on your screen, move the cursor to ZOOM and press Button #1. This submenu appears:

```

ORGN
WIN
IN
OUT
SIZE

```

2. Move the cursor to OUT and press Button #1.

3. Move the cursor to the center of the drawing area and press Button #1 again. The shapes become much smaller, and your screen should look something like this:

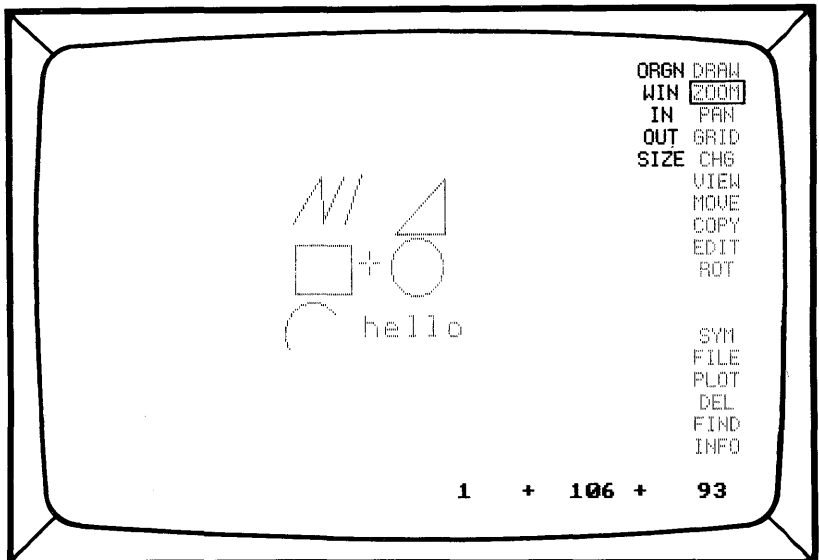

To increase the size of your drawing, select ZOOM and IN.

### PROCEDURE: PAN

1. Move the cursor to PAN and press Button #1.
2. Move the cursor to the upper left corner of the working area and press Button #1. The shapes on your screen shift to the lower right, allowing you to work on the rest of the screen. Your screen should look something like this:

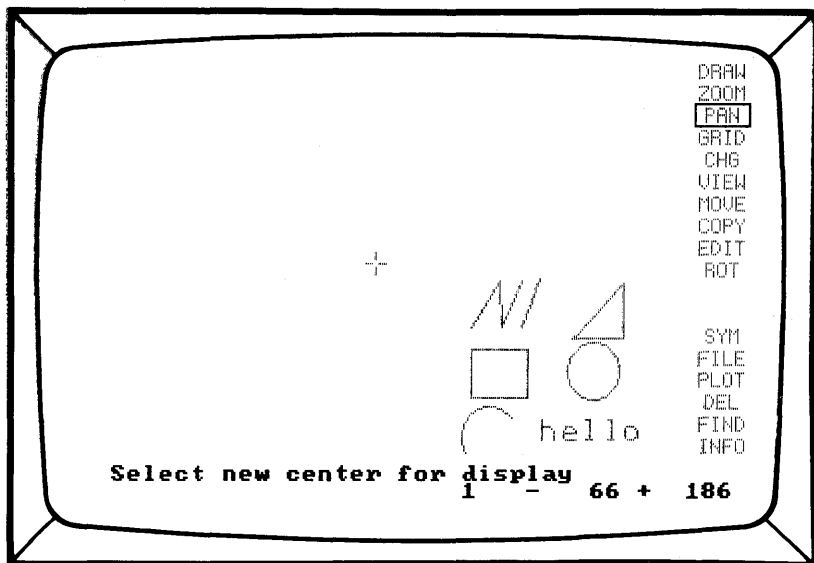

**Note:** It's possible, when you're using PAN, for your design to disappear completely from the screen. If this happens, you can use VIEW and FIT to bring it back into the work space.

---

# Lesson Four

## WIN and IDEN

These two options are available through any of the following main menu commands:

CHG (Change)  
MOVE  
COPY  
ROT (Rotate)  
DEL (Delete)

Though these main menu commands are covered only briefly in this tutorial, you can use WIN and IDEN to expand their functions in several ways.

You can use WIN to select a “window” of objects. This is done by moving the cursor to the lower left corner (press Button #1) and upper right corner (press Button #1 again) of an imaginary window enclosing the objects. The objects in the window are highlighted and can now be moved, copied, rotated, and so forth at one time. In order for you to use WIN to enclose a group of objects, all the objects must be on the same layer.

IDEN allows you to select or “identify” specific items, not necessarily connected or adjacent to one another, by positioning the cursor over each one and pressing Button #1. When you’ve finished selecting the items, press Button #2--the objects can now be moved, rotated, copied, and so forth at one time.

**Reference Point:** When using WIN or IDEN, you’re sometimes asked to choose a reference point. This is the point of reference from which the objects will be taken and placed in the new drawing when MOVE or COPY is used, or around which the objects will rotate when ROT is used.

# Lesson Five

## Changing Layers

The CHAnGe command can be used either to change layers or to transfer data from one layer to another.

With CADDRAFT, you have seven layers. Each layer can have a different line type and color. You can work with these layers using CHG alone or with one of these submenu commands:

WIN  
IDEN  
0-7

### **PROCEDURE: Change the Active Layer**

Move the cursor to CHG and press Button #1--you'll see this prompt:

(C)hange active layer, or  
(T)ransfer item(s) to another layer?

Type **C**. You'll see this prompt:

Btn1 - select new active layer Btn2 - change

To select the new active layer, first move the cursor over 0 in the submenu and press Button #1. Then select a number from 2-7 and press Button #1 again. Now press Button #2 to change the active layer to your new selection.

You can now draw on the new layer. At the bottom of the screen, the new layer is identified on the status line. To change back to layer 1, use the same procedure.

### **PROCEDURE: Move a Shape from one Layer to Another**

Move cursor to CHG and press Button #1--you'll see this prompt:

(C)hange active layer, or (T)ransfer item(s) to another layer?

---

Type **T**. You'll see this prompt:

Btn1 - select layer to transfer to Btn2 - change

Move the cursor over 0 in the submenu, and press Button #1. Then move the cursor over 5 and press Button #1 again. Press Button #2 to confirm layer 5 as your new layer selection to transfer items to. You'll see this prompt:

Select item(s) to transfer to layer 5

Move the cursor to any point on the rectangle and press Button #1. Notice that the rectangle is converted to the color and line type of layer 5.

Repeat the same procedure to move the rectangle back to layer 1.

# Lesson Six

## MOVE, COPY, ROTate

The MOVE command enables you to take shapes or sections of designs and move them to other locations in the drawing area.

The COPY command allows you to make multiple copies of shapes or sections of designs.

The ROTate command rotates design objects.

### PROCEDURE: Use MOVE

1. First, move the cursor to DRAW and press Button #1.
2. Move the cursor to RECT and press Button #1. Now draw a box adjacent to the design items you created in Lesson One. Use ZOOM to make the items smaller if necessary. Your screen should look something like this:

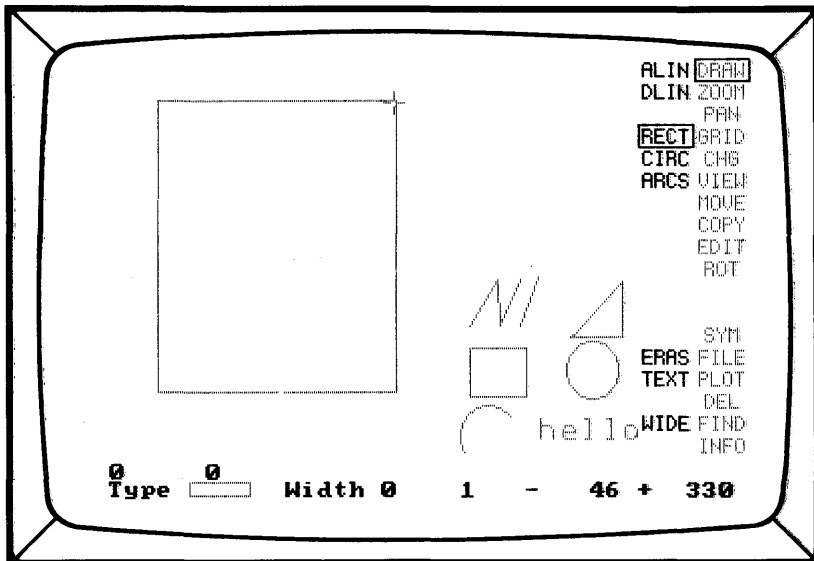

3. Move the cursor to the MOVE command and press Button #1.
4. Move the cursor to the circle and press Button #1 (the cursor must be touching a part of the circle). You'll see this prompt:

Btn1 - Select and move item Btn2 - Release

5. Move the cursor inside the box and press Button #1 to position the shape and Button #2 to release it. Your shape is now in the box.
6. You may also drag the object around the screen by pressing and holding down Button #1 as you move the cursor. Pressing Button #2 will release and place the object.

Repeat the procedure until all the objects are in the box. Remember when selecting text to position the cursor at a point just before the first word.

When you're finished, your screen should look something like this:

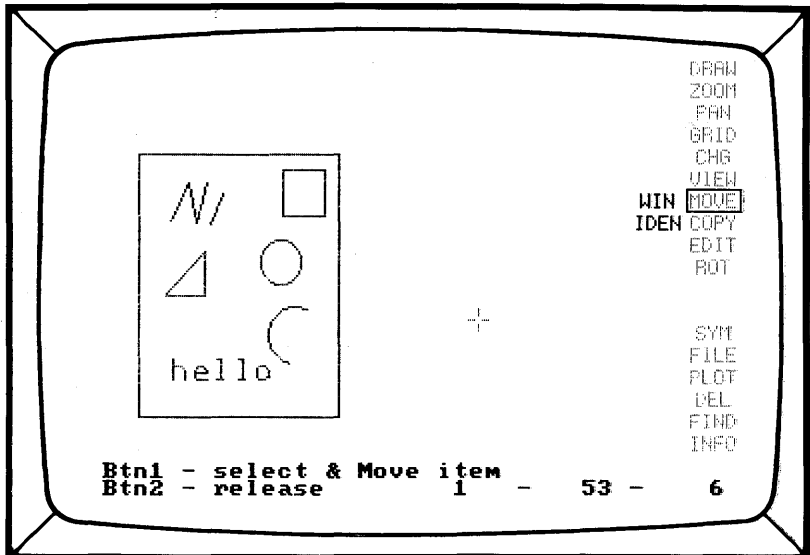

### PROCEDURE: Use COPY

Now make another box--you'll copy the same shapes into the box using the COPY command.

**Note:** If the box you've made is too small to contain all the shapes, use PAN to shift the screen or ZOOM to make the shapes smaller.

1. Move the cursor to COPY and press Button #1-- you'll see this prompt:

Btn1 - select & Copy item Btn2 - release

2. Move the cursor to any point on the shape you want to copy (or to the point just before the first letter of text) and press Button #1.
3. Move the cursor into the box and press Button #1 again. The shape is placed in the box. You can continue to press Button #1 to place more copies of the same shape in the box.

Continue to place your shapes in the box, using the COPY command, until your screen looks like this:

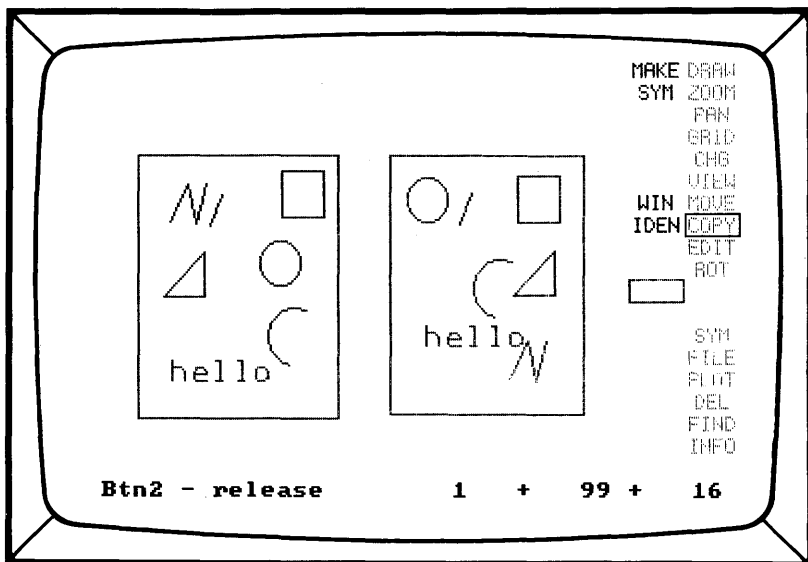

### PROCEDURE: ROTate the Triangle

1. Move the cursor to ROT and press Button #1. If you like, you can now use DEGR (degree) to choose the number of degrees to rotate the selected item(s). Otherwise, rotation takes place in 90 degree increments.



2. Move the cursor to one of the intersections on the triangle and press Button #1.
3. Press Button #1 again to rotate. Notice that the triangle rotates in 90 degree increments-- unless you used DEGR to specify a different number of degrees.
4. Press **R** on your keyboard to reverse the rotation.
5. To release the triangle, press Button #2.

Your screen should resemble this:

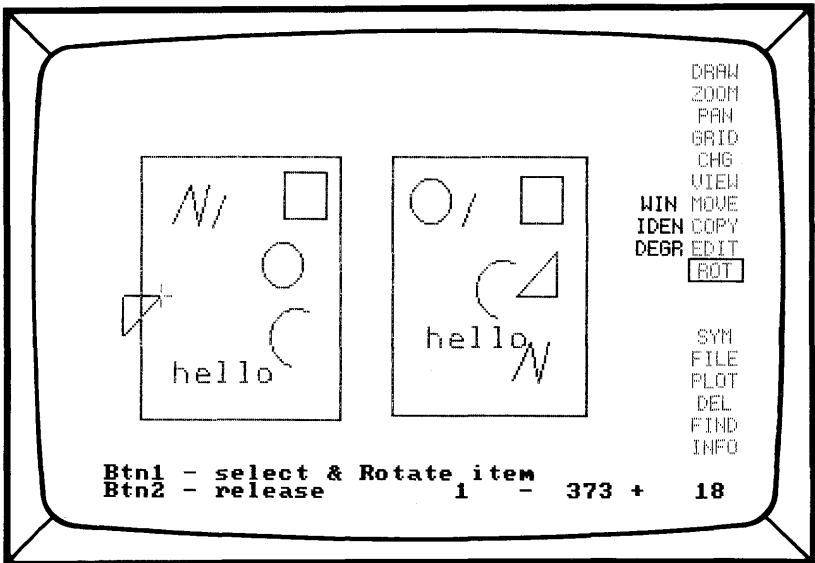

## PROCEDURE: Rotate TEXT

Choose ROTate and press Button #1. Move the cursor to a point just before the first letter of text and press Button #1 again. When the text is highlighted, follow the screen prompts to rotate the text.

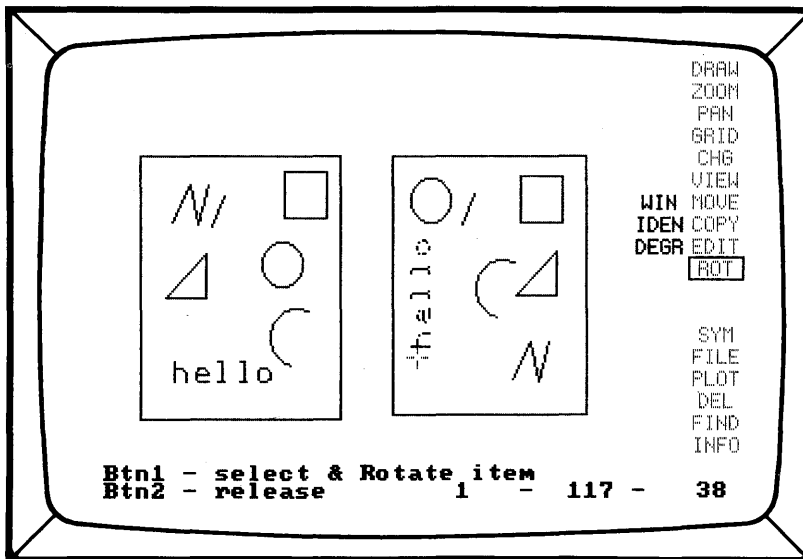

---

# Lesson Seven

## DELeTe

DELeTe removes items from the screen. Items removed using DELeTe are not, however, permanently removed from the data base. They can be restored using DEL UNDO.

### **PROCEDURE: Delete the Rectangle**

1. Move the cursor to DEL and press Button #1.
2. Move the cursor to any point on the rectangle and press Button #1. The rectangle is deleted.

### **PROCEDURE: UNDO DELeTe**

1. Move the cursor to DEL and press Button #1.
2. Move the cursor to UNDO and press Button #1. The rectangle is returned to the screen.

---

# Lesson Eight

## SAVE, PLOT, or PRINT

Before a design is plotted or printed, it should be saved to a diskette. After saving your design, CADDRAFT returns you to your design screen.

To plot or print, you must answer a series of questions asked in the form of prompts. You'll need to indicate the size of the hard copy, the scale, and whether or not you want a heading.

In this lesson, you'll be saving and printing the box with shapes that you created in the earlier lessons. You won't explore all the save or print options available with CADDRAFT--they're covered in complete detail in Chapter 5.

### PROCEDURE: SAVE

Save a drawing with the FILE command on the main menu.

1. Move the cursor to FILE and press Button #1-- you'll see the following submenu:

```
DIR
LOAD
PACK
SAVE
BKUP
ZAP
ERAS
QUIT
```

2. Move the cursor to SAVE and press Button #1--you'll see the following prompt:

Filename:

3. Type a name for your file--it can be up to 8 characters. For now, name your file **BOX** and press (Return). Your file is saved on the disk, ready to retrieve any time you want to work with it again.

---

**PROCEDURE: Output to a Printer**

Before beginning a print routine, you must fit and center your entire design on the screen using ZOOM, PAN, or VIEW/FIT. Here's how:

1. Move the cursor to PLOT and press Button #1-- you'll see this submenu and prompt:

PNTR

PLTR

STRT

Select PLTR (plotter) or PNTR (printer)

2. Move the cursor to PNTR on the submenu and press Button #1--now you'll see this prompt:

Select scale, <CR>, then STRT (start)

Type in the scale you want to use for your drawing. An example of a scale could be 1/4 in = 1 ft. With CADDRAFT you can select a scale in feet, inches, tenths, mils, units and so forth.

For instance, if you select 1/4 in = 1 ft, every 1/4 inch on the plot will be equal to 1 foot. A "frame" will surround the drawing. If the frame is too large or too small, try another scale--for example, 1/8 in = 1 in or 1/2 in = 1 in.

When you are satisfied with the placement of your drawing within the "frame", press Button #1.

3. Move the cursor to STRT and press Button #1-- you'll see this prompt:

BTN #1-move plot window. BTN #2-pick # of plots, P to start.

4. At this point you may adjust the position of the window by pressing Button #1.

5. Choose the amount of plots you want with Button #2, or just press P from the keyboard to print one copy of the design on your printer. For now, go ahead and press **P** to print--you'll see this message:

Plotting will take approximately 2 minute(s) and require \_\_\_\_ sheet(s)  
Continue (Y or N)?

6. Check to see that you have enough paper in your printer to complete the printing of your drawing(s). Then press **Y** to continue--you'll see this message:

Turn on PRINTER then press any key.

7. Make sure that your printer is on and press any key--you'll see this prompt:

Include messages? Y for yes, or any key.

8. Press **Y** to include the messages seen on the lower left of your screen with the printout. These messages tell you the sheet number of the drawing(s) as they print out, and also the scale you have selected for your drawing(s). An example might be:

Sheet 1 of 1

1/4" = 1'

9. Press any other key to print drawings only.

Your design should now be printing. If it's not, consult the checklist in Chapter 5, Section 14 of this manual.

### **PROCEDURE: Output to a Plotter**

1. Move the cursor to PLOT and press Button #1-- you'll see this submenu and prompt:

PNTR

PLTR

STRT

---

Select PNTR (printer) or PLTR (plotter).

2. Move the cursor to PLTR on the submenu and press Button #1. Now you'll see this prompt:

FILE SHOULD BE SAVED BEFORE CONTINUING!  
Hit A to abort PLOT, or any key

If you haven't yet saved your plot, abort the plot routine by pressing **A** on the keyboard. If you have saved the plot, continue by pressing any key.

3. If you have not already selected a plotter through the INFO command --you'll now see this prompt:

PLOTTER NOT SELECTED Dos Error #\_\_\_\_ Hit any key

See Lesson One, INFO, to select a plotter and then continue to plot your drawing(s). Press any key--you'll see this prompt:

Select scale, <CR> then STRT (start)

4. Type in a scale you want to use for your drawing. An example could be 1/4 in = 1 ft. With CADDRAFT you can select a scale in feet, inches, tenths, mils, units, and so forth. For instance, if you select 1/4 in = 1 ft, every inch on the plot will be equal to 1 foot.

When you've selected a scale for your plot, a "frame" will surround the drawing on your screen. If the "frame" is too large or too small, try another scale--for example, 1/8 in = 1 in or 1/2 in = 1 in. When you are satisfied with the placement of your drawing within the "frame", press Button #1.

5. Move the cursor to STRT and press Button #1-- you'll see this prompt:

BTN #1-move plot window. BTN #2-pick # of plots, P to start.

---

You can adjust the window to fit your drawing at this point by pressing Button #1 and moving the cursor around the drawing area.

6. When the window is positioned as you want it, press **P** to start--you'll see this prompt:

Plotting will take approximately 2 minute(s) and require \_\_\_\_ sheet(s)  
Continue (Y or N)?

7. Check to see that you have enough paper in your plotter to complete the printing of your drawing(s). Then press **Y** to continue--you'll see this message:

Turn on PLOTTER then press any key.

8. Make sure that your plotter is on and press any key--you'll see this prompt:

Include messages? Y for yes, or any key.

9. If you want the scale you've chosen to be printed on the plotted sheet and a frame to be drawn around the drawing, press **Y** at this point. Otherwise, press any other key to begin plotting.

10. If you are plotting more than one page, you will see this prompt:

When plotter stops, change sheets  
Any key to continue, A to Abort PLOT.



---

# Lesson Nine

## File LOAD

### PROCEDURE: LOAD

1. To load an existing file from a diskette, move the cursor to FILE and press Button #1.
2. Move the cursor to LOAD in the submenu and press Button #1--you'll see this prompt:

Existing database will be overwritten Continue? Y/N

Select **Y**.

3. You'll now see this prompt:

Filename:

4. Type in the name of the file to LOAD--in this case, type **BOX**, then press (Return). The file previously saved to disk is loaded into your computer.

---

# Lesson Ten

## Designing with Precision: GRID and VIEW

A CADDRAFT grid is a series of reference points displayed on the screen that can be used for precision drawing. The grid can be made larger or smaller using the SET command in the GRID submenu.

The cursor can be locked with the LOCK command in the GRID submenu, or by pressing **G** on the keyboard. When the grid is locked, the cursor will “snap” to the grid when Button #1 or #2 is pressed. You can define and use up to 10 different grids. These can be seen on the INFO page.

VIEW provides a variety of options for examining layer information and “refreshing” a design after editing and moving.

Now create the same sequence of shapes, using GRID, as you saved previously. If you need help refer back in the tutorial.

### PROCEDURE: GRID

1. Move the cursor to GRID and press Button #1-- you'll see a submenu that looks like this:

```
DISP
LOCK
SET
1
2
3
4
5
6
7
8
9
10
```

2. Move the cursor to SET and press Button #1-- you'll see this prompt:

Select grid # to set (1-10)

3. Move the cursor to 3 and press Button #1-- you'll see this prompt:

New X Grid ? (2 to 1000) Grid #3 X = # Y = #

4. Enter **12** for both the new X and the new Y grid coordinates, then press (Return). The new grid is displayed.

12 represents twelve database units. Since you're working in feet and inches (where the smallest unit of measurement is one inch), 12 DBU = 1 foot.

If you were working in tenths, 12 DBU would equal 12/10 of an inch or 1.2 inches; in mils 12 DBUs would equal 12/1000 of an inch.

5. Now move the cursor to LOCK and press Button #1.

You now have a grid that is set up so that the cursor will "snap" to the nearest grid point. The distance between any two grid points on the grid is one foot.

If the grid is too small, use ZOOM to adjust it until you feel comfortable.

To turn the grid display off, type **D** on the keyboard--the grid disappears. Type **D** again--the grid reappears. You can turn your grid on and off as often as you wish. This is called a "toggle switch," much like a light switch. You can also turn your grid on and off through the GRID menu.

To turn the grid lock off, type **G** on the keyboard--the G at the bottom of the screen disappears. You can now draw between the points of the grid. Type **G** again to turn the grid lock on again. You can turn the grid lock on or off as you work, depending on the precision you need. You can also turn it on and off through the GRID menu.

With the grid lock and grid display on, continue.

Move the picture off the screen using PAN. Draw some design shapes in the new area, using whatever commands you like--DRAW, ROT, MOVE, ZOOM, VIEW, and PAN.

Move and rotate the shapes. If gaps appear in your design after you've moved shapes around, use VIEW/REDO.

---

# Lesson Eleven

## SYMBOLS

SYM and COPY are the commands used to create, store, retrieve, place, and view symbols.

A symbol is a design item--a desk, a chair, or even a building elevation--that will be used more than once or in more than one design. Symbols can be stored in a CADDRAFT file and recalled for repeated use.

COPY/MAKE SYM will store one symbol at a time.

SYM/SAVE will store an entire data base (up to 3000 vertices).

### PROCEDURE: Create a Symbol

Create two symbols from your design. Use the entire contents of the design as the first symbol, and the triangle as the second symbol.

1. First, retrieve your file named BOX. Select FILE/LOAD from the main and submenus and follow the prompts.
2. To store the entire layout as a symbol, select SYM/SAVE--you'll see this prompt:

Before saving ... select origin

3. Move the cursor out to the working area and choose a vertex or other place on the drawing as an origin--that is the point you'll use as a reference when adding the symbol to other designs.

It's always a good idea to mark your origin point at the same place--for example, in the lower left corner of your symbol. Press Button #1--you'll see this prompt:

Filename:

4. Type in a filename--in this case use **BOXSYM**. Press (Return)--BOXSYM is saved as a symbol.

---

5. To store the triangle as a symbol, first move the cursor to COPY and press Button #1.

6. Move to MAKE SYM on the submenu and press Button #1--you'll see this prompt:

To save a (WIN)dow area as a symbol,  
Pick LL and UR pts

Move the cursor to the lower left corner of the "window" and press button #1.

7. Move the cursor to the upper right corner of the "window" and press Button #1--you'll see this prompt:

Proceed with symbol save? Y/N

If the symbol is highlighted correctly, press **Y**. If you need to realign the lower left and upper right points again, enter **N**. If you select **Y**, you'll see this prompt:

Btn1... select origin

Choose a point of origin and press Button #1. It's always a good idea to mark your origin point at the same place--for example, in the lower left corner of your symbol. When you've selected your point of origin, you'll see this prompt:

Filename:

Type **TRIANGLE** and press (Return)--your shape is saved as a symbol under the filename TRIANGLE.

### **PROCEDURE: Recalling Stored Symbols**

1. Move to a blank space on your screen using PAN.

---

2. Move the cursor to SYM and press Button #1-- you'll see this submenu:

DIR  
LOAD  
LIST  
PLAC  
SAVE

3. Select Load to load a symbol into your computer's memory for editing or placement in a design. You'll see this prompt:

Filename:

4. Type **BOXSYM** and press (Return)--you'll see this prompt:

Load symbol for (P)lace or (E)dit?:

(E)dit allows you to make changes to a single symbol and store it again under the same name. Note that Edit loads a symbol just like a database, clearing the entire screen before loading.

(P)lace allows you to load one or more symbols for placement in a design. Type **P** for placement-- you'll now see this prompt:

Filename:

5. Type **TRIANGLE** and press (Return) to load the TRIANGLE symbol.

**Note:** You cannot make a symbol out of other symbols. This is called "symbol nesting" and you will receive an error message.

6. To list a directory of all symbol files currently on disk, first select SYM from the main menu and then DIR from the submenu. You'll see this prompt:

Drive for symbol directory (A-G)?

---

7. Type the letter of the disk drive containing your symbol files. You'll see this prompt:

Symbol Prefix (1 or 2 characters)

A symbol prefix can be used to isolate a group of symbols. Examples of isolation might look like this:

Drive for symbol directory (A-G)? A  
Symbol Prefix? (1 or 2 characters)? AB

ABC .SYM ABCCHAIR.SYM ABCDESK .SYM ABCPLANT.SYM  
ABCRUG .SYM ABCEXEC .SYM ABCFILE .SYM ABCSYM .SYM

8. Press the SPACEBAR to continue.

If you entered the prefixes shown, these files would be listed--

AB	CB	XY
ABCDESK	CBRADIO	XYZ
ABCRUG	CBSUGAR	XYCOORD

But these would not--

AGREE	CHAIR	XMAS
DOG	CAT	RAT

Press the SPACEBAR to return to the main menu.

9. To list the active symbols, first select SYM from the main menu commands and then LIST from the submenu. Active symbols (those that have been loaded by first selecting SYM and LOAD) will be listed. LIST allows you to select a symbol from this list for placement into the design. Your Screen should resemble this:

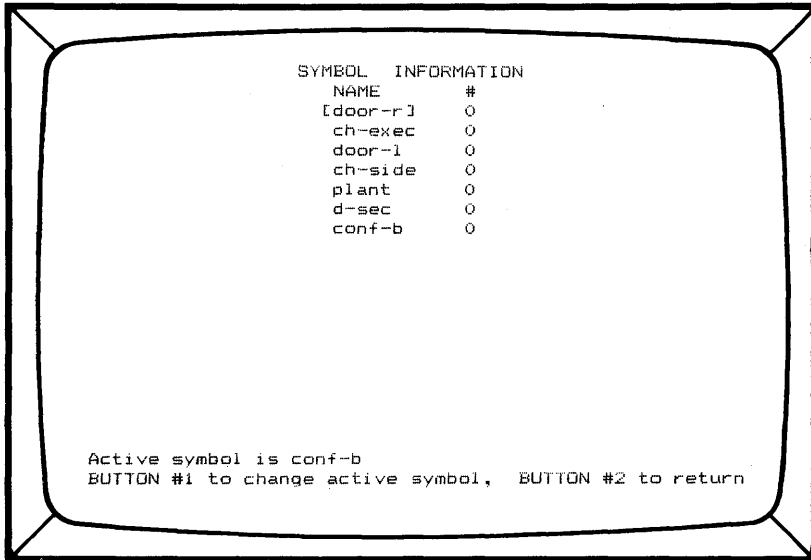

To select a symbol for placement, press button #1, until a box appears around the symbol you want to place; then press button #2. That symbol becomes the active symbol, ready for placement.

To place a selected symbol in a drawing, move the cursor to PLAC and press button #1. Now move the cursor to the desired location and press button #1. You can make single or multiple placements.

**Note:** Once a symbol is placed, it cannot be edited.

You now have experience with the basic techniques for using CAD-DRAFT. As you explore the other options in the menus, remember--you can always press the ? for on-line help.



# Chapter 5

---

# Commands

CADDRAFT is made up of 16 Main Menu commands, 50 Submenu Commands, and a handful of Keyboard Commands. These are explained in this Chapter.

Section 1—Command Summary. This section provides a brief description of each of the Main Menu and Submenu commands.

Sections 2-17—Commands. These sections describe each command in detail.

Section 18—Keyboard Commands. Each Keyboard Command is explained.

---

# Section 1

---

## Command Summary

The following is a brief summary of CADDRAFT commands.

---

**DRAW** - The DRAW command and submenu options allow the user to enter design data. A status line at the bottom of the screen reflects the degree and length of lines and the radius of circles and arcs.

ALIN - (ANY LINE) - Allows the user to draw lines at any angle by digitizing a beginning and ending point.

DLIN - (DEGREE LINE) - Draws lines which snap to a user specified angle. Most common use is 45 degrees for orthogonal line entry.

RECT - (RECTANGLE) - Rectangular objects are drawn from two diagonal corner points.

CIRC - (CIRCLE) - Draws 2 point circles of a user specified radius or 3 point circles defined by 3 points on the circumference.

ARCS - Draws 2 point arcs of a user specified radius and arc length or 3 point arcs defined by 2 end points and a 3rd point on the circumference.

ERAS - (ERASE) - Erases the last item entered.

TEXT - Text can be inserted into a drawing at any size and at a choice of four angles. It can be left, right, or center justified.

WIDE - (WIDE) - Sets line width for graphic entry of lines, rectangles, circles and arcs.

---

**ZOOM** - The ZOOM command contains a number of submenu items which provide ease of movement around a drawing.

ORGN - (ORIGIN) - Positions the screen display according to a user specified window origin.

WIN - (WINDOW) - Selects a portion of the drawing (using a window) for a new screen display.

IN - Zooms in in increments of two for more detail. This command can be repeated multiple times. This will automatically center the drawing, or allow you to choose the center point.

---

**OUT** - Zooms out by a factor of two for more overview. This command can be repeated multiple times. Also allows you to choose the center point and automatically center items.

**SIZE** - Enables the user to choose the new display ratio of the drawing on the screen.

---

**PAN** - Moves the screen view of the drawing to the left, right, up, down, or diagonally.

---

**GRID** - Grids are used like graph paper to provide exact points for placement of design objects. Grids can be displayed or not displayed, locked or not locked. 10 Grid sizes are pre-set for quick recall.

---

**CHG** - (CHANGE) - The CHG command works with layers to change the active layer, or transfer items from one layer to another.

**WIN** - (WINDOW) - Selects window of items to be transferred to another layer.

**IDEN** - (IDENTIFY) - Identifies disconnected items to be transferred to another layer as a group.

---

**VIEW** - Various options for VIEWing your drawing.

**FIT** - Fits your entire design in the screen boundaries.

**REDO** - Redraws a screen after editing to restore any screen images that have been disturbed. Also used after **VIEW - ALL/ACTV** , or **LAY** to reflect the changes made.

**ALL** - Displays all layers on the screen.

**ACTV** - (ACTIVE) Displays only the active layer.

**LAY** - Displays selected layers on the screen.

---

**MOVE** - Moves simple design items from one place on a drawing to another.

---

WIN - (WINDOW) Selects a window of items to be moved.

IDEN - (IDENTIFY) Identifies disconnected design items to be moved as a group.

---

**COPY** - Design items can be copied once or multiple times by selecting COPY alone, or with one of the submenu items: WIN and IDEN. Copies of items can be retained as SYMBols to be reused in other drawings with the submenu item MAKE SYM.

MAKE SYM - (MAKE SYMbol) - A design item or entity can be stored to be used in different drawings. This feature eliminates repetitive drawing of commonly used design elements.

WIN - (WINDOW) - Selects window of items to be copied.

IDEN - (IDENTIFY) - Identifies disconnected items to be copied as a group.

---

**EDIT** - The EDIT commands permit the designer to EDIT basic design elements.

ADDV - (ADD VERTEX) - Adds a vertex to a line segment. This vertex can then be used to edit the line by moving it with MOVV. The vertex can also be used with Vertex Locking to position design elements precisely.

MOVV - (MOVE VERTEX) - Moves a vertex to change the line shape. Lines are dynamically stretched.

DELV - (DELETE VERTEX) - Deletes a vertex.

BRK - (BREAK) - Breaks a line, circle, or arc at two points.

MOVL - (MOVE LINE) - Moves an existing line. Attached lines are dynamically stretched.

---

**ROT** - (ROTATE) - Rotates objects. Objects are rotated 90 degrees at a time unless DEGR is chosen also.

WIN - (WINDOW) - Selects window of items to be rotated.

---

IDEN - Identifies disconnected items to be rotated as a group.

DEGR - (DEGREE) - Allows the user to select the degree of rotation in 5 degree increments.

---

**SYM** - (SYMBOL) - The SYMBol commands manage the creation, storage, and retrieval of SYMBols. Other commands relating to SYMBols are in COPY (MAKE SYM) and FILE (ERAS).

DIR - (DIRECTORY) - Shows a directory of SYMBols.

LOAD - Loads SYMBols from disk storage to the active drawing area.

LIST - Displays a list of the SYMBols which have been loaded to the active drawing and the number of times each SYMBol has been placed.

PLAC - (PLACE) - Places SYMBols in the active drawing.

SAVE - Saves data as a SYMBol and places it in storage.

---

**FILE** - Manages the users' Database Files.

DIR - (DIRECTORY) - Shows a directory of Database Files stored on the user specified default disk drive.

LOAD - Loads a file from disk storage onto the screen.

PACK - Permanently deletes design data removed by the DEL (DELETE) command. Before this is used, or the file is SAVED, the data can be returned with DEL/UNDO.

SAVE - Writes the active file to disk.

BKUP - Saves a file with the SYMBols used in it, to a user specified disk drive.

ZAP - Erases the active drawing from the screen and clears the database.

ERAS - (ERASE) - Erases a file from the disk.

QUIT - Exits to the operating system.

---

**PLOT** - Sends items to a plotter or a dot matrix printer with graphics capability.

---

**DEL** - Deletes design items from the screen.

**UNDO** - Returns items to the screen that have been deleted since the last **SAVE** or **PACK**.

**WIN** - (**WINDOW**) - Selects window of items to be deleted.

**IDEN** - (**IDENTIFY**) - Identifies disconnected items to be deleted as a group.

**0-7** - Used to select **LAYer** to restore deleted data or **DELeTe** an entire layer.

---

**FIND** - Finds information about design items.

**DATA** - Finds information such as **LAYer**, and **SYMBOL** information.

**DIST** - (**DISTANCE**) - Computes the distance between two points.

---

**INFO** - Sets parameters for your design, such as default drives, grid sizes, units of measurement, size of text, **LAYer** line type and color, and type of input and output devices.

---

Two additional programs have been included with **CADDRAFT 1.4**, but which must be run separately are:

**CPSCALE** - Rescales symbols to different Database Units.

**CPTRANS** - Translates 1.30 and 1.35 files to 1.40 format.





# Section 2

**COMMAND:** DRAW

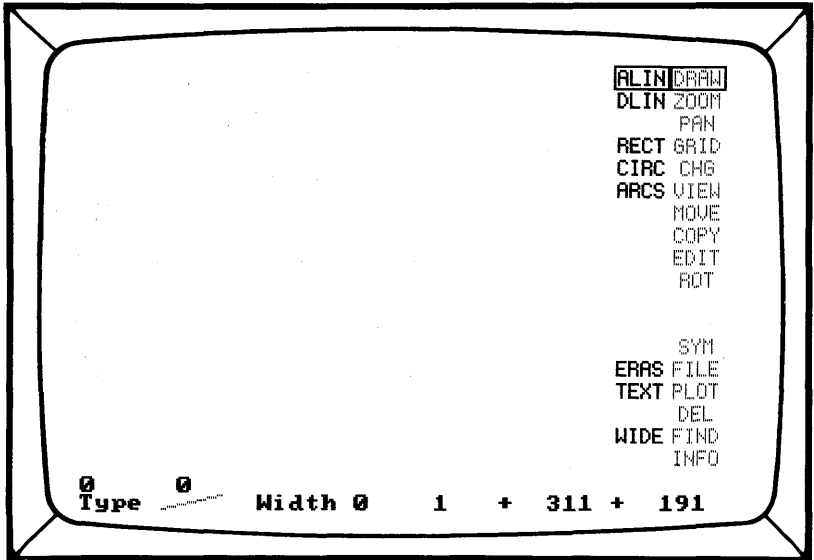

**PURPOSE:**

Allows creation of design data

**EXIT:** Press Esc key or Button #2

**PROCEDURE:**

Select DRAW and choose a submenu option.

When any of the design data types above are selected, two status lines are displayed at the bottom of the screen. The first status line displays the angle and length of the line from the last point entered to the cursor. The second status line displays the data or line type and color, current line width, active layer and the X and Y coordinates of the cursor position. They look like this:

```
220      3 Ft. 5 In.
Type    _____ Width 0      1 + 260 - 90
```

As you DRAW, the angle and length display and the X and Y coordinate display on the status line are automatically updated to reflect the new cursor position. Note that while the cursor is in motion, the displays are unchanged. The update occurs immediately after the cursor stops moving.

GRID locking is frequently used with the DRAW commands to simplify data entry and insure the accuracy of a design. For example, GRID lock might be used to input a series of lines a set distance apart.

If you wish to DRAW with absolute precision while you are zoomed out to the extent that you have many world coordinates per pixel, use the keyboard step keys and the X key (in place of Button #1) and the space bar (in place of Button #2). When you use the step keys you may be moving the cursor a slight distance even though the cursor doesn't appear to move on the screen. However, the X, Y coordinate and line length displays are updated to reflect the new cursor position. Use of the X key in place of mouse Button #1 insures accurate coordinate entry.

NOTE: Any of the design shapes may look a little distorted depending on the resolution of the screen. For instance, squares may look slightly rectangular, or circles may not be exactly round. They will, however, plot with precision.

---

**SUBCOMMAND: ALIN****PURPOSE:**

(Any LINE) Draws line segments at any angle

**EXIT:** Press Esc key or Button #2

**PROCEDURE:**

Select DRAW from the Main Menu and ALIN from the submenu.

To draw ALINs, position the cursor at the starting point and press Button #1. Move the cursor to locate the line end point. A dashed line will “rubberband” between the first point entered and the cursor. The angle and line length display will be updated (status line #1).

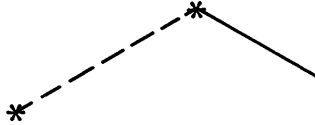

When the line is positioned correctly, press Button #1 again to confirm the line placement.

The line will now become the line type and color of the active layer.

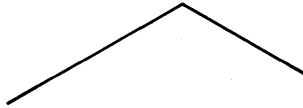

Move the cursor to another point. The line continues to rubberband from the last point entered. Press Button #1 again. The line is entered.

You now have a line with connected vertices, which will function as a single entity when selected for MOVE, COPY, ROTate, etc. When edited using the EDIT commands, such as MOVL, one line will move and the other will stretch to meet it.

To release the line and begin a new line (with ALIN still engaged), press Button #2.

---

**SUBCOMMAND: DLIN****PURPOSE:**

(Degree LINE) DLIN draws lines which are snapped to 45 degree angles.

**EXIT:** Press Esc key or Button #2

**PROCEDURE:**

Select DRAW from the Main Menu and DLIN from the submenu.

Position the cursor at the starting point and press Button #1. Position the cursor at the end of the line segment and press Button #1 again.

To move to a new starting vertex, press Button #2 to release and Press Button #1 again at the new location.

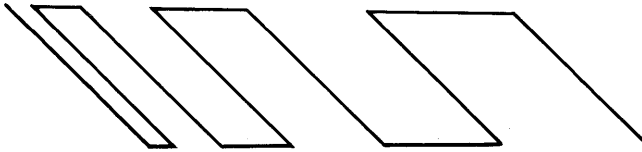

Connected angled lines

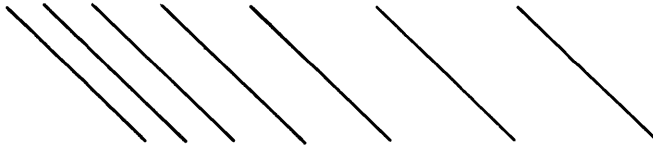

Disconnected angled lines

---

**SUBCOMMAND: RECT****PURPOSE:**

Draws RECTangles.

**EXIT:** Press Esc key or Button #2

**PROCEDURE:**

Select DRAW from the Main Menu and RECT from the submenu. Draw a RECTangle by digitizing two diagonal corners. Move the cursor into the drawing area to the point where the first corner of the RECTangle will be. Press Button #1. Move the cursor to the diagonal corner, Press Button #1 again. If you wish to release the command to move to a new starting point, Press Button #2.

The "rubberbanding" feature allows you to see the size of the RECTangle, (as a dashed line), before it is digitized into the database.

Start at a vertex point.

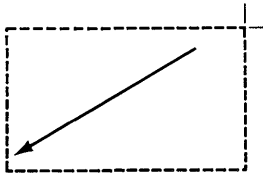

Rubberband until it is positioned correctly.

Press Button #1 to confirm.

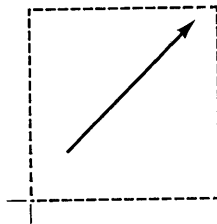

---

You can draw any type of RECTangle with this command.

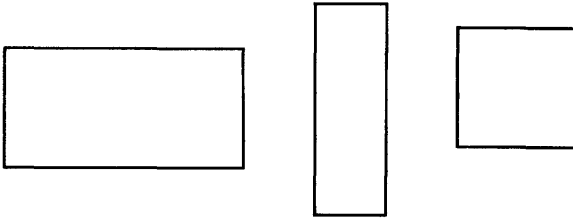

The measurement at the bottom of the screen represents the angle of the diagonal of the RECTangle and the width (X) and height (Y) of the RECTangle

NOTE: RECTangles consist of five vertex points. The four points of the RECTangle and the original vertex comprise the five points.

**SUBCOMMAND:** CIRC**PURPOSE:**

Draws CIRCles.

**EXIT:** Press Esc key or Button #2

**PROCEDURE:**

Select DRAW and CIRC.

CIRCles are created in two ways:

1. By digitizing a center point and a radius (default)
2. By digitizing 3 points - (Press 3 on the keyboard after choosing CIRC)

Option #1: CIRCles are created by digitizing a center first, (Button #1), and then a radius, (Button #1).

The rubberbanding feature allows you to see the size and position of the CIRCle, (as a dotted line), before it is confirmed. The status line displays the angle and the radius of the circle.

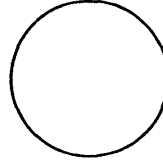
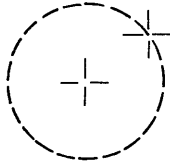

Digitize center point      Button #1 to confirm  
and radius using Button #1

To temporarily release the CIRCle command and start over, Press Button #2.

Option #2: CIRCles are created by digitizing three points, accomplished by pressing the number **3** on the keyboard while in the CIRCle mode. The status line will say:

3 point circle

---

Locate 3 points on the circumference and press Button #1 at each point.

Point #1

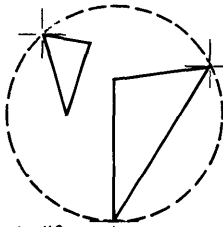

Point #2

Point #3

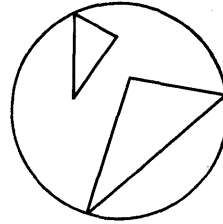

Confirmed by

Button #1

To temporarily release the CIRCLE command and start over, Press Button #2.



**SUBCOMMAND:** ARCS

**PURPOSE:**

Draws ARCS.

**EXIT:** Press Esc key or Button #2

**PROCEDURE:**

Select DRAW and ARCS.

ARCS are created in two ways:

1. By digitizing a center point and radius, or
2. By digitizing 3 points - (press 3 from the keyboard after pressing ARCS)

Option #1: ARCS are created by digitizing a center first, (Button #1), and then a radius, (Button #1). At this point there is a "rubberbanded" CIRCle. Move the cursor around the edge of the "rubberbanding" arc to determine the arc length and press Button #1 to confirm.

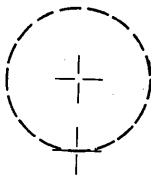

Defining

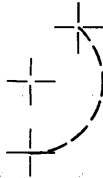

Confirmed with Button #1

To temporarily release this feature to change the vertex points, press Button #2.

Option #2: ARCS created by digitizing three points are achieved by pressing the number 3 on the keyboard. The status line will say:

3 point arc

---

Locate 3 points on the circumference and press Button #1 at each point.

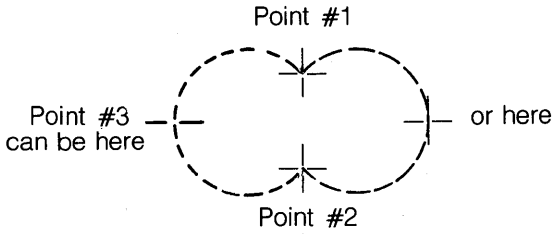
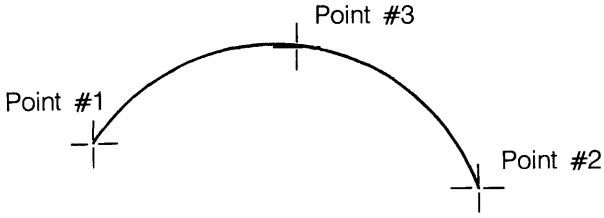

You can drag Point #3.

To temporarily release this feature to reposition the cursor, press Button #2.

The degree of the arc angle and length of the radius are displayed in the status line.

Example: 180 4'6"

---

**SUBCOMMAND: ERAS****PURPOSE:**

Erases last entry in layer

**EXIT:** Move cursor to next selection

**PROCEDURE:**

Select DRAW and ERAS. You do not have to move the cursor to the object you want to ERASe. The last entry in the active layer will be ERASed.

ERASe is used while in the DRAW command to eliminate the last item(s) drawn. To use the ERASe option, create some data. Select the ERASe option. Press Button #1 to ERASe each entry in succession.

**NOTE:** Because a rectangle is created from line segments, it ERASes segment by segment. Circles and arcs ERASe completely each time Button #1 is pressed.

**IMPORTANT:** When ERASe is selected, the item is permanently removed from the database. It will not be returned with UNDO.

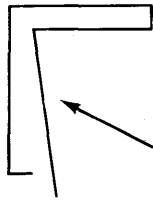

When you make a mistake

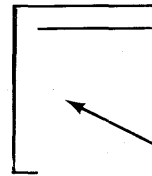

Press ERASe

---

**SUBCOMMAND:** TEXT**PURPOSE:**

Draws letters, numbers, or other keyboard characters

**EXIT:** Press Esc key

**PROCEDURE:**

Select DRAW from the Main Menu and TEXT from the submenu. You will see this prompt:

Move cursor to location for 1st letter then press Button #1.

The monitor will display a flashing horizontal line to indicate the location and the width of the characters. You will see this prompt:

Angle: 0 Number: 3 Size: 18  
Type in text or spacebar to change

**NOTE:** The default size for TEXT is always number 3. Refer to the INFO page (Item #17) to find out what other TEXT sizes are available, or to establish a new TEXT size.

If you don't want to change the angle, number, or size, enter the TEXT exactly as you would on a typewriter. Use the following keys for editing:

Backspace to delete one character at a time.  
Press the Enter or (Return) key to end the string.  
Press the Esc key to erase the current string.

If you do wish changes, press the Spacebar. You will see this prompt:

Change (A)ngle, (N)umber  
(S)ize or (J)ustification?

---

At this point you can change any of the above options by entering **A**, **N**, **S**, or **J**. Your options are:

A = Angle:0 - 3

N = Number:1 - 15

S = Size:1 - 1500 DBU's

J = Justification:(Left),(C)enter,(R)ight

If you type **A**, you will see the prompt:

Current angle is 0  
Select new angle (0,1,2 or 3)

The numbers 0, 1, 2, and 3 correspond to the following angles:

ANGLE	ANGLE 0	ANGLE 1
3	ANGLE 2	ANGLE

If you type **N**, you will see the following prompt:

Current number is 3  
Select new number (1-15):

This number is associated with the TEXT sizes created as defaults on the INFO page.

If you type **S**, you will see the following prompt:

Number to change (1-15)?

This allows you to change the size associated with a particular TEXT number. The TEXT page in INFO will automatically be updated.

---

**IMPORTANT:** Any other TEXT created using the TEXT number being changed will also be changed.

If you type **J**, you will see the following prompt:

Current justification is on the LEFT  
Select (L)eft, (C)enter, or (R)ight

RIGHT  
JUSTIFIED

CENTER  
JUSTIFIED

LEFT  
JUSTIFIED

### Samples of TEXT Justification

It is a good idea to turn GRID LOCK OFF before entering TEXT. For information on TEXT sizing, check the INFO section of Menu Commands.

---

**SUBCOMMAND: WIDE****PURPOSE:**

Increases width of lines

**EXIT:** Press Esc key**PROCEDURE:**

Select DRAW and WIDE to set the width of lines.

You will see this prompt:

Current line width = 0  
Enter line width (0-127):

Enter the number of Database Units for the line width. WIDE lines can be drawn with ALIN, DLIN, and RECT. CIRCles or ARCs will also have a line width equal to the number of DBUs. The WIDE line command will remain active until you turn it off by selecting a width of **0**.

For ALIN, DLIN, AND RECT, the line will display with the width on the left side following the direction of travel.

For example, a line input from left to right will display the width upwards.



A line input from right to left will show the width downwards from the line.



Likewise, a line created from top to bottom will show width to the right of the line,



A line drawn from bottom to top will show width to the left side.



Rectangles also follow the direction of creation

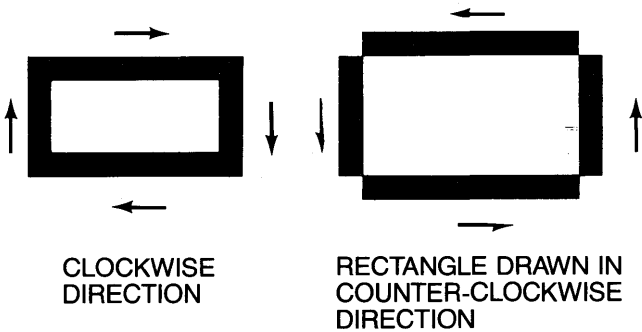



---

Circles and Arcs - The Width Builds Out



NOTE: When printed, a dot matrix printer will fill in the WIDE lines. Most plotters will not fill in the lines. However, a Hewlett-Packard 7475, 7580 or 7585 plotter or JSC plotter will crosshatch straight WIDE lines.

---

# Section 3

**COMMAND:** ZOOM

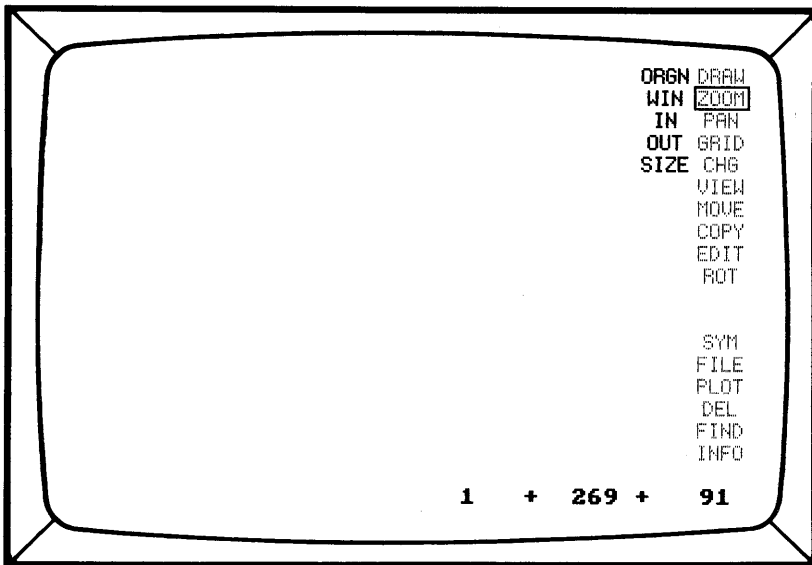

**PURPOSE:**

Enlarges or reduces viewed area

The ZOOM command has a series of submenu items which will enable you to make the apparent size of your drawing larger or smaller on the screen, (even though the actual size does not change).

**EXIT:** Press Esc key

**PROCEDURE:**

Select ZOOM and a submenu option.

---

**SUBCOMMAND:** ORGN**PURPOSE:**

Allows positioning the screen display according to exact X and Y coordinates.

The new coordinates will be at the lower left of the screen.

**EXIT:** Press Esc key

**PROCEDURE:**

Choose ZOOM and ORGN. You will see this prompt:

Window origin:  
New X? (-32768 to 32767)  
  
New Y? (-32768 to 32767)

The current window origin (lower left point on the screen) is shown in the prompt.

Choose the new window origin by typing in the X coordinate and press (Return). Enter the Y coordinate and press (Return). This X,Y coordinate will be shown on the lower left corner of the screen.

**SUBCOMMAND: WIN****PURPOSE:**

Selects a WINDOW for the new screen. You can select a portion of the drawing for a new screen display by creating a WINDOW around it.

**EXIT:** Press Esc key

**PROCEDURE:**

Choose ZOOM and WIN. You will see this prompt:

Btn 1 - Select LL & UR points

Choose the lower left and upper right portions of the window of the new screen display. Press Button #1 after each choice.

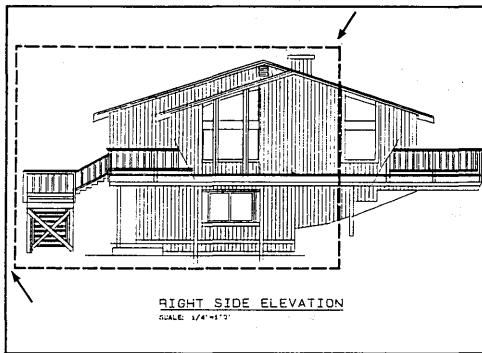

Pick a WINDOW

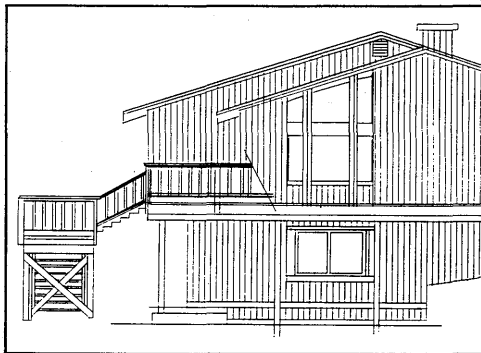

It becomes your new screen

---

**SUBCOMMAND:** IN or OUT**PURPOSE:**

Enlarges or reduces picture size

**EXIT:** Press Esc key or Button #2

**PROCEDURE:**

Select ZOOM and IN or OUT. You will see this prompt.

select point... 2x per hit

Do one of the following:

1. Leave the cursor on the IN or OUT option and press Button #1 (This option ZOOMS in or out from the center of the screen), or
2. Move the cursor to a point on the drawing and press Button #1. (This will let you determine the new center point.)

Button #1 can be pressed once to either double (IN), or halve (OUT) the picture size, or it can be pressed multiple times (within 1/2 second each) to continue reducing or enlarging the picture by increments of 2.

Options:

IN - Reduces the viewed area of your design.

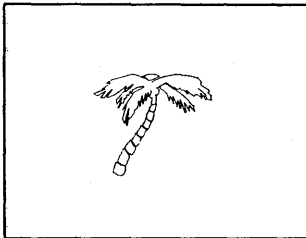

From this

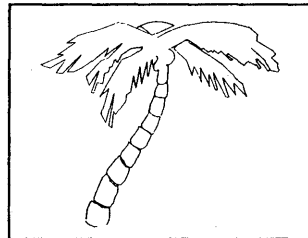

To this

---

OUT - Enlarges the viewed area of the design.

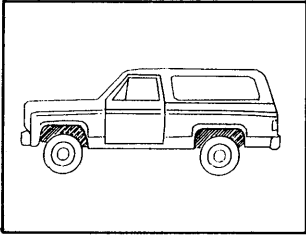

From this

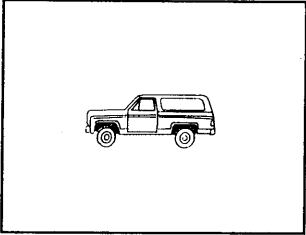

To this

---

**SUBCOMMAND: SIZE****PURPOSE:**

Change display ratio. This feature lets you choose a specific numeric display ratio to enlarge or reduce the drawing display.

**EXIT:** Press Esc key.

**PROCEDURE:**

Select ZOOM and SIZE. You will see this prompt:

Present ratio:  
New ratio:? (.004 - 32.0)

Type in a number (may be a decimal). If the number you type in is smaller than the present display ratio, the apparent SIZE of your design will be smaller, and visa versa.

The Display Ratio is the relationship of pixels to Database Units. This is explained in more detail in the INFO Section of Chapter 6, under Display Ratio.

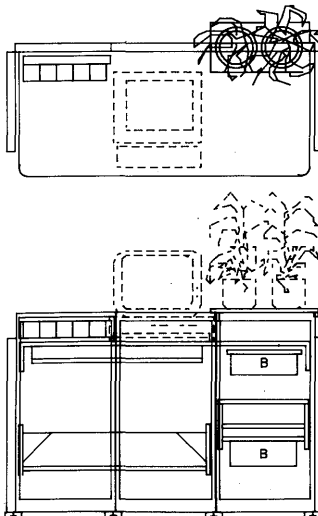

Ratio of 1.325



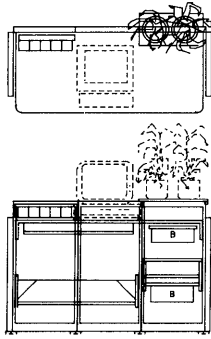

New Ratio of .95



# Section 4

**COMMAND:** PAN

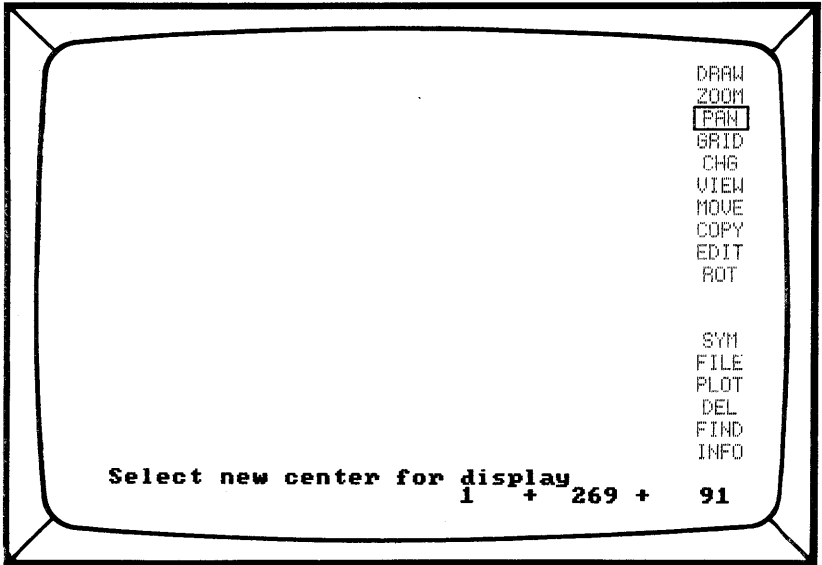

**PURPOSE:**

Shifts the viewed area

This command allows you to move to different sections of your design. It functions much like a camera PANning over a landscape. If you have considerable detail on a drawing, you can PAN to check it. It can also be used to move your data entirely off the monitor to work in another area.

**EXIT:** Press Esc key

**PROCEDURE:**

Select PAN. The monitor displays:

Select new center for display

Move your cursor to a new location and press Button #1.

---

The system will redisplay your design with the cursor position as the center of the new view.

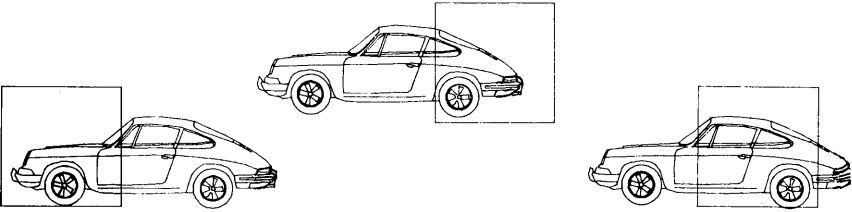

PAN will shift the viewed area.

# Section 5

**COMMAND:** GRID

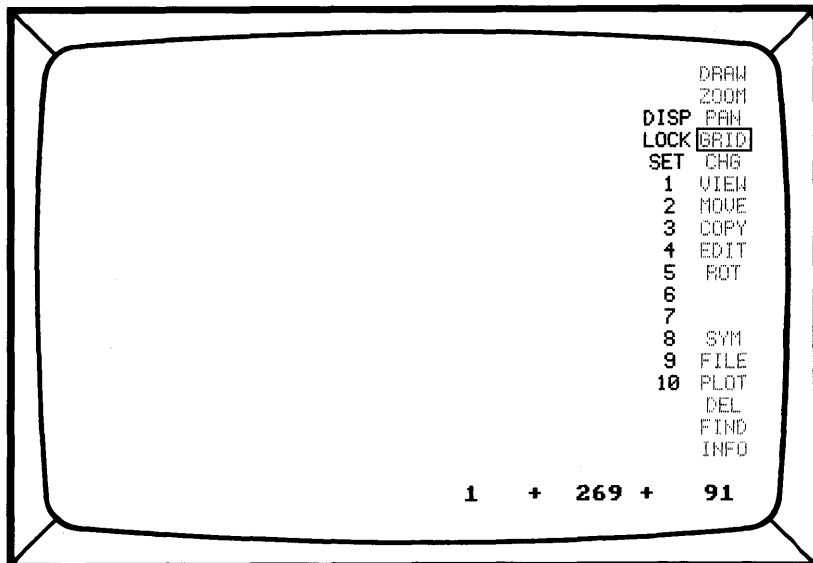

**PURPOSE:**

Shows an array of points on monitor for reference when entering design data.

NOTE: See GRIDS under CAD System Concepts (Chapter 2) of this manual. Refer to Keyboard Commands (Chapter 5, Section 18) for step sizes, GRID display, and GRID lock toggles.

**EXIT:** Move cursor to next selection

**PROCEDURE:**

Select GRID and a submenu option:

Ctrl G : - Press **Ctrl G** to find the active GRID, GRID size, and whether the GRID is on.

The screen displays:

```

active grid is #3   Display OFF
X = 12 Y = 12

```

**SUBCOMMAND:** DISP

**PURPOSE:**

Displays the grid.

**EXIT:** Press Button #1

**PROCEDURE:**

Select DISP and the screen displays a dot at every grid point.

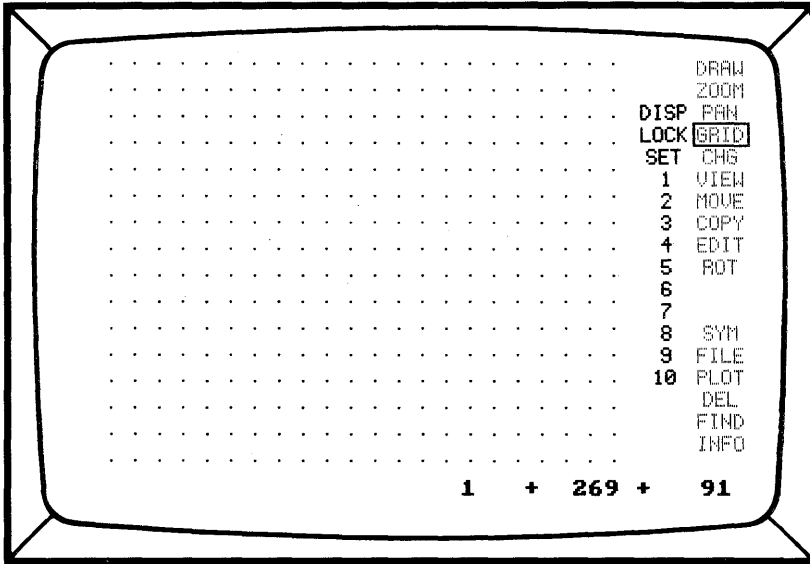

GRID displayed

If the GRID size is too small to be displayed you will see this message:

Grid too small

The grid can still be "active", even when it is too small to be displayed.

The GRID is still active and can be "locked" although it does not appear.

The GRID DISPLAY can also be turned on and off, or "toggled" from the keyboard, by typing the letter **D**.

---

**SUBCOMMAND: LOCK****PURPOSE:**

Digitized points "snap" to the grid.

**EXIT:** Press Button #1

**PROCEDURE:**

Select GRID. and LOCK. The message at the bottom of the monitor will read **G**.

When the GRID LOCK is on, every point digitized "snaps" to the closest GRID point, whether the GRID is displayed or is too small to display.

GRID LOCK can be turned off by selecting LOCK again.

GRID LOCK can also be turned on and off, or "toggled" by typing **G** on the keyboard.

**SUBCOMMAND: SET****PURPOSE:**

This option allows you to define up to 10 grid sizes.

**EXIT:** Press Esc key

**PROCEDURE:**

Select SET and you will see the following prompt:

Select grid # to set (1-10)

Select a number from the submenu using Button #1. You will then be prompted:

NEW X GRID (2 to 1000)  
GRID #1 X = 6 Y = 6

Type in a new X coordinate, press (Return).  
Type in a new Y coordinate, press (Return).

The new grid will be displayed.

The GRID/SET feature is also found in the INFO menu. This allows you to set default Grid sizes.

**HINT:** Grids can be extremely useful if they are set up properly. For instance, if your DBU = 1/2 In., you may wish to set:

GRID 1 = 2 DBUs (1 In.)  
GRID 2 = 12 DBUs (6 In.)  
GRID 3 = 24 DBUs (1 Ft.)  
GRID 4 = 120 DBUs (5 Ft.)

and so forth. You can continue to change grids as your need to fill in detail or draw large design elements changes.

**NOTE:** When grid lock is **ON**, the step size is ignored. Each time you press an **ARROW** key, the cursor moves one grid point. For information on step sizes, see the Keyboard Commands section (Chapter 5, Section 18).



# Section 6

**COMMAND:** CHG

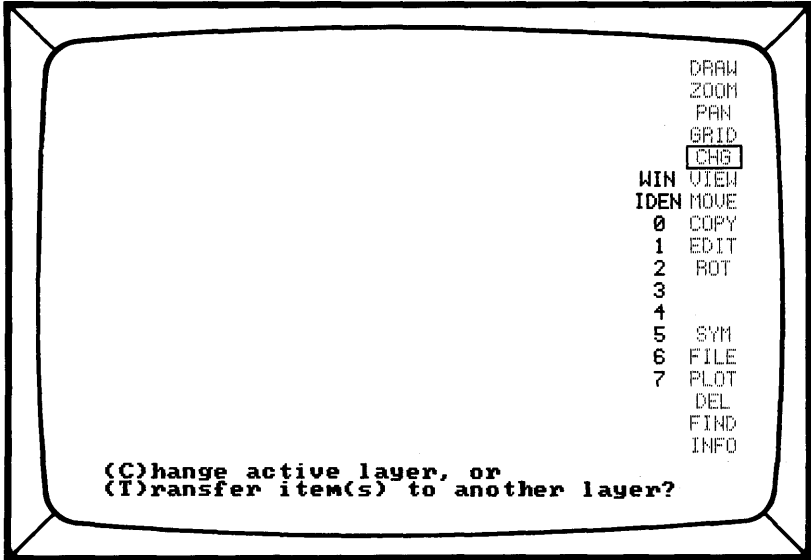

**PURPOSE:**

CHanGes the active layer or transfers data from one layer to another.

The first number (1) represents the active layer. The other numbers are used to choose a new layer.

**EXIT:** Press (Return) key

**PROCEDURE:**

Select CHG, you will then see this prompt:

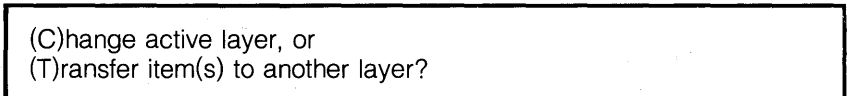

Press keyboard **C** or **T**.

---

If you select (C)hange, you will see the following prompt:

Btn1 - select new active layer  
Btn2 - change

Select the layer with a double digit entry (01, 02, 03, etc.) For example, to select layer #7, move to 0 and press Button #1. Then move to 7 and press Button #1. Now press Button #2 to change to the new layer selection.

This layer is now the active layer. The layer number on the status line will be updated.

If you select (T)ransfer, you will see this prompt:

Btn1 - select layer to transfer to  
Btn2 - change

Follow the directions above for changing layers. The selected layer is the layer the items will be transferred to.

You will see the following prompt:

Select item(s) to transfer to layer \_\_\_\_

Move the cursor to the item to be transferred and press Button #1. The item will be redrawn with the line type and color of the new layer. If you wish to transfer a group of items, select the WIN or IDEN commands.

HINT: An effective way to make a copy of all data on another layer is to use the CHanGe command to transfer the data from one layer to another, (CHanGe layers), and then UNDO the original layer.

---

**SUBCOMMAND:** WIN**PURPOSE:**

Transfers a WINDOW of design items

**EXIT:** Press Esc key

**PROCEDURE:**

Select CHG. You will be prompted:

(C)hange active layer or (T)ransfer items to another layer?

Select **C** or **T**

If you select **C**, you can change the active layer with a 2 digit command. Confirm with Button #2.

If you select **T**, you will see the following prompt:

Btn1-Select layer to transfer to  
Btn2-Change.

Select the layer to transfer to with a 2 digit command. Select WIN - you will be prompted:

Btn1 - Select LL & UR points

Select the window of items to be transferred using Button #1. The objects inside the window will now be highlighted. You will see this prompt:

Btn1 - change Btn2 - cancel

If you press Button #1, the selected items will be transferred and redrawn with the line type and color of the new layer.

**NOTE:** To transfer items from a current layer to a new layer using WIN, design items must be on the current layer. After the transfer, CADDRAFT switches to the new layer.

---

**SUBCOMMAND: IDEN****PURPOSE:**

IDENTifies design items, one by one and transfers them as a group

**EXIT:** Press Esc key

**PROCEDURE:**

Select CHG. You will be prompted:

(C)hange active layer or (T)ransfer items to another layer?

Select **C** or **T**

If you select **C**, you can change the active layer with a 2 digit command. Confirm with Button #2.

If you select **T**, you will see the following prompt:

Btn1 - select layer to transfer to Btn2 - change

Select the layer to transfer to with a 2 digit command. Select **IDEN**. You will then be prompted:

Btn1 - add selected items  
Btn2 - stop adding

Select the items you want to add to the group to be transferred using Button #1. Press Button #2 to stop adding and confirm selection. You will then be prompted:

Btn1 - change  
Btn2 - cancel

If you press Button #1, the selected items will be transferred and redrawn with the line type and color of the new layer.

NOTE: CHanGe actually makes a copy of the item on the new layer and marks the item on the present layer as deleted. If an undelete, (DEL/UNDO), is performed later, the original item will reappear. Use the FILE and PACK command to permanently remove the deleted data.

---

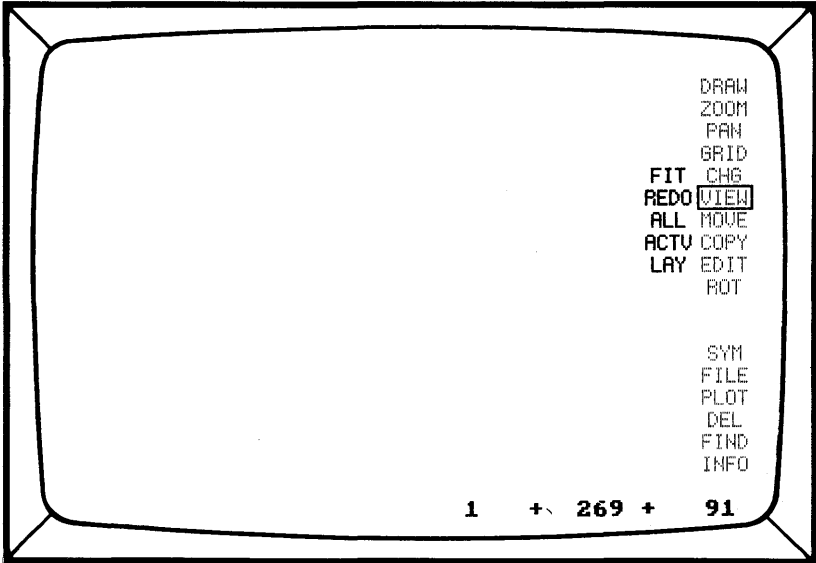
**COMMAND: VIEW****PURPOSE:**

Options for VIEWing the Design

The VIEW submenu commands allow the user to view the drawing in many different ways involving size and layers. It also has a command, REDO, for redrawing a screen display if some of the pixel images are disturbed.

**EXIT:** Move cursor to next selection

**PROCEDURE:**

Select VIEW from the Main Menu and choose a Submenu option.

---

**SUBCOMMAND:** FIT**PURPOSE:**

FITS Your drawing onto the Monitor

This command scans your entire database and FITs it onto the monitor. It is a useful command if you temporarily get lost in your design.

**EXIT:** Move cursor to next selection

**PROCEDURE:**

Select VIEW and FIT. You will then see this message:

Locating database boundaries

Your entire drawing, including all the viewed layers, will be redrawn on the screen.

**NOTE:** Text on the outer edges of your design may not be included in the redraw. Place a rectangle around your text to mark it for FITting.

Even though the world is 65,535 x 65,535, it is only possible to VIEW 65,534(X) and 43,570(Y) at one time. If the Y value exceeds 43,570 units, the system will FIT as much of the database as is possible, leaving the remainder of the drawing to be viewed with a single pan to the top of the screen.

If you are working on a portion of your design, you can bring it all to the screen with VIEW/FIT

---

**SUBCOMMAND: REDO****PURPOSE:**

Redraws all data on the currently VIEWed layers.

This option is useful in "cleaning up" the drawing after editing, moving, or copying if some of the pixel images are erased.

If any grid points are erased during editing operations, they will be displayed once again after REDO.

**EXIT:** Move cursor to next selection

**PROCEDURE:**

Select VIEW and REDO.

If you want to stop the REDO before it is finished, press the space bar. The data remains in the database, but will not be displayed on the screen.

REDO should also be used after VIEW/LAY, and VIEW/ALL or ACTV to show the new layers viewed. It can be used after COPY/MAKE SYM to return data to its original color.

---

**SUBCOMMAND:** ALL and ACTV

**PURPOSE:**

Instructs CADDRAFT to display ALL the layers or just the ACTIVE layer.

ALL - All layers become visible.

ACTV - Only the current or active layer is visible.

**EXIT:** Move cursor to next location

**PROCEDURE:**

Select VIEW and ALL or ACTV.

REDO must be used to display the VIEWed layers after they have been set.

Select VIEW, ACTV, and REDO to view the ACTIVE layer only. You will see this message:

Only layer \_\_\_\_ is viewed

To return the unviewed layers, use the VIEW, ALL, REDO commands. Data stored on all layers will now appear on the monitor. You will see this message:

All layers are viewed

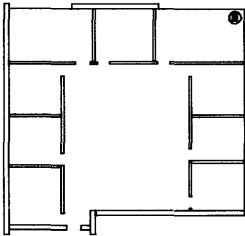

ACTIVE layer

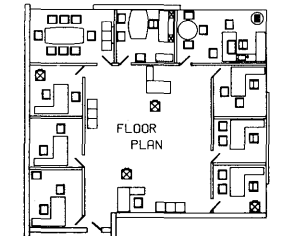

ALL layers



**SUBCOMMAND: LAY****PURPOSE:**

Turns LAYers On and Off

This option allows you to see selected LAYers by turning the LAYers on and off. You can see one, all, or a selection of LAYers.

LAY will display the LAYer Page of the "INFO" command, showing the LAYers that are currently being viewed, (or displayed), and the percentage of each LAYer that is filled with design data. It also shows pen settings for plotters and the INFOrmation associated with each LAYer.

**EXIT:** Press Button #2

**PROCEDURE:**

Select VIEW and LAY

To change the VIEWed layers, select the layer using Button #1, then select either YES or NO with Button #1.

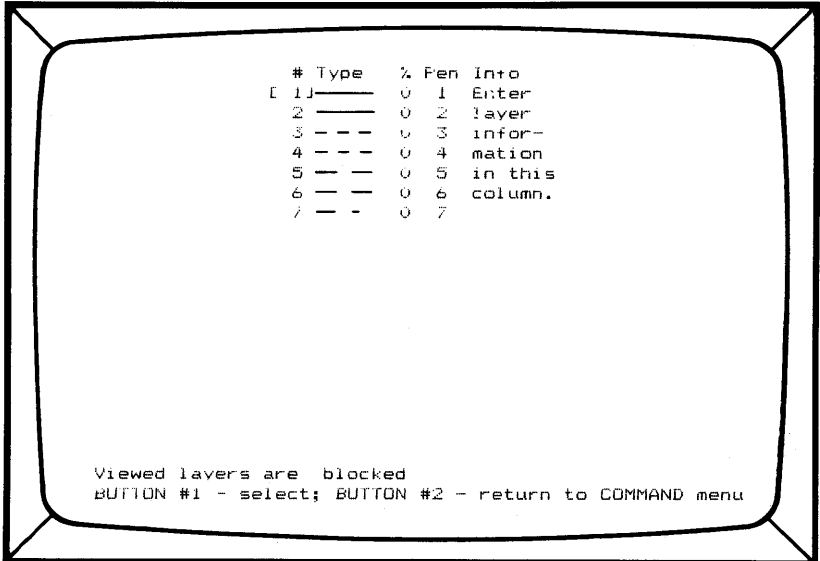

**NOTE:** Be careful when choosing LAYers that contain SYMBols to view. You must have visible the LAYers the SYMBols were created on, as well as the LAYers the SYMBols were placed on. See SYMBol Commands, (Section 12), for more information.



# Section 8

## COMMAND: MOVE

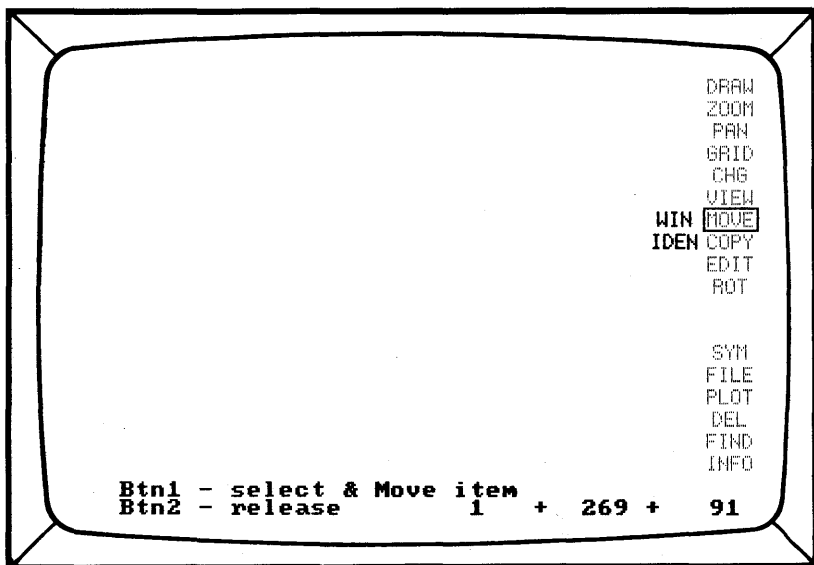

### PURPOSE:

Moves existing data to new locations

The MOVE command is used to move existing data, either single or groups of design elements, from one place on a layer to another.

**EXIT:** Press Esc key

### PROCEDURE:

Select MOVE.

MOVE can be used without options to move one object with connected vertices, (data, text, or SYMBols), at a time. Select MOVE from the main menu. You will then see this prompt:

Btn1 - select & Move item  
 Btn2 - release

Move the cursor to any place on the object. Press #1. The object will be highlighted.

CADDRAFT will move to the layer the object is placed on.

Move the cursor to the new location, and press Button #1 again. The object will be moved to a new location on that layer.

For precision, you can move objects with the GRID lock on (GRID/LOCK or keyboard G).

You may hold down Button #1 to "drag" the object to the desired location, and then press Button #2 to place it in the desired position. It is recommended that the grid lock be turned off while "dragging" objects across the monitor unless you want to snap objects to GRID points.

### Reference Point:

In WIN and IDEN, you will be asked to pick a "reference point". This point will be the place where the object enters the new location. For instance, if you are moving a desk from one room to another, you will choose a reference point, like the lower left corner, for easy positioning in the next picture. Think of it as the "handle" of your design.

NOTE: Single items can be moved from any layer-- you do not need to be in the active layer. Also, single items do not need a reference point. The point you use to select the item is used as the "handle".

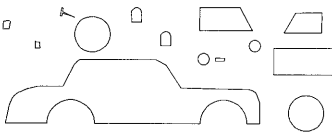

Choose a vertex  
Press Button #1

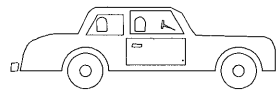

MOVE and Press Button #1

**NOTE:** Move was used several times to assemble this drawing.

---

**SUBCOMMAND: WIN****PURPOSE:**

MOVES a WINdow of Design Data

A box or WINdow of data is designated and moved. The active layer must be the layer the items were created on.

**EXIT:** Press Esc key

**PROCEDURE:**

Select MOVE, and WIN. You will see this prompt:

Btn1 - Select LL & UR points

This means to choose the lower left, and upper right of the WINdow. Press Button #1 for each point. All items selected in the window will be highlighted.

You will see this prompt:

Btn1 - Select point to move from  
Btn2 - Release

Now, choose a reference point, and press Button #1. You will see this prompt:

Btn1 - Select point to move to  
Btn2 - Release

Move the cursor to the new location and press Button #1. The items will be MOVED and redrawn in their original color.

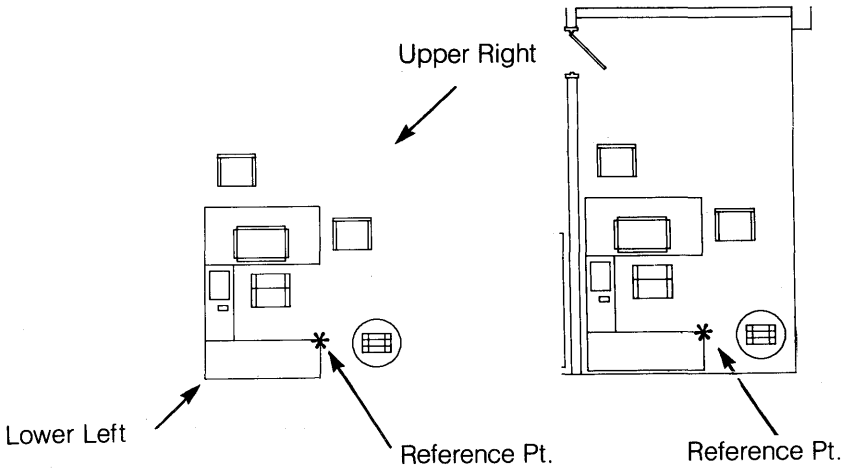

Select lower left and upper right points. Then select the reference point to move from. Now place the object by the reference point.

---

**SUBCOMMAND: IDEN****PURPOSE:**

IDEN selects multiple items and moves them as a group. The items must be on the same layer. The active layer must be the layer the items were created on.

If you are unsure as to what layer the items are on, use the FIND/DATA commands.

**EXIT:** Press Esc key

**PROCEDURE:**

Select MOVE, and then IDEN. You will see this prompt:

Btn1 - add selected items  
Btn2 - stop adding

Position the cursor on any spot on the first object to be moved. Press Button #1. The object will be highlighted.

Now repeat the step for multiple objects. When you have IDENTified all the objects that you wish to move, press Button #2. You will see this prompt:

Btn1 - Select point to move from  
Btn2 - Release

Move the cursor to a reference point. Press Button #1. You will see this prompt:

Btn1 - Select point to move to  
Btn2 - Release

Move the cursor to the new location and press Button #1 again. You can "drag" items by holding down Button #1 and moving the cursor around the screen. To confirm the position, press Button #2.

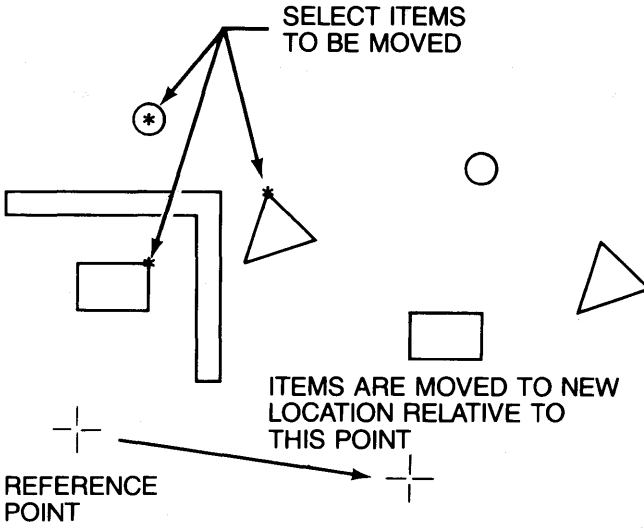

IDENTify group and select the reference point.



# Section 9

**COMMAND:** COPY

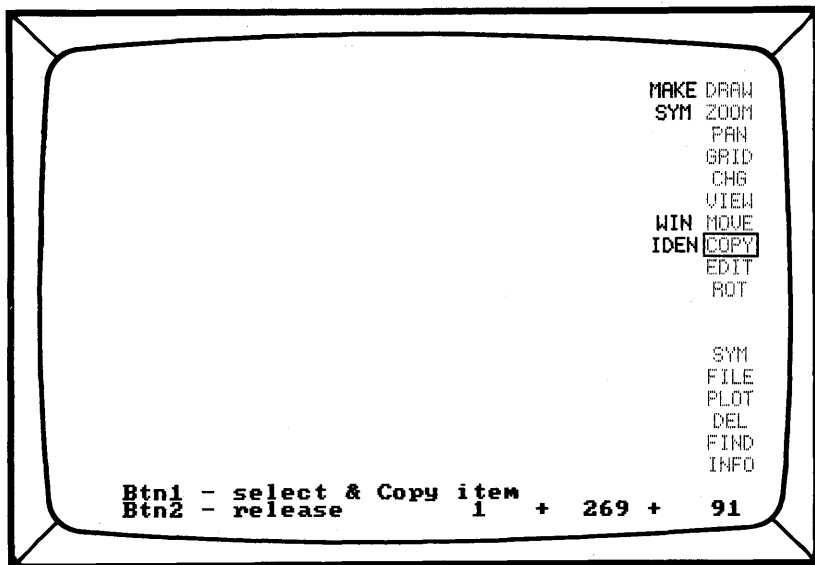

## PURPOSE:

COPY copies an item or group of items to a new location. COPY also makes hard data into SYMBols.

CADDRAFT will move to the layer the first object it is placed on when COPY is used alone. COPY used with any of the other subcommand options will require that you move to that layer before COPYing.

If COPY is used without a submenu option, it will duplicate existing items with connected vertices, one at a time.

For precision, you can COPY objects with the GRID Lock on (GRID/LOCK or keyboard G).

## Reference Point:

In WIN and IDEN, you will be asked to select a "reference point". This point will be the place where the object enters the new location. For instance, if you are moving a desk from one room to another, you would pick a reference point, like the lower left corner for easy positioning in the next picture. Think of it as the "handle" of your design.

---

Symbols use their "origin" as the reference point. With TEXT, the reference point is a vertex below and to the left of the first character of text in a string.

**EXIT:** Press Esc key

**PROCEDURE:**

Select COPY. You will see this prompt:

Btn1 - select & Copy item  
Btn2 - release

Move the cursor to any point on the object to be copied. CADDRAFT will move to the layer that object is placed on. Press Button #1. The object will then be highlighted.

Move the cursor to the new location using the place where you originally put the cursor as the reference point. Press Button #1.

Repeat this step to place multiple copies in your design.

When you are finished, press Button #2 to release the original object.

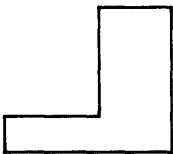

Choose a simple object  
(Origin if a SYMBOL or Text)

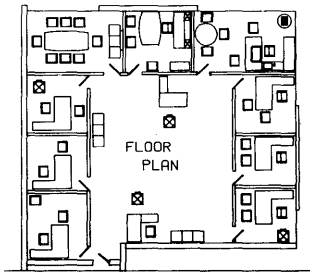

COPY it once or multiple times

---

**SUBCOMMAND: MAKE SYM****PURPOSE:**

Makes a SYMbol

This option allows you to save objects in your design as a SYMbol. MAKE SYMbol allows you to WINdow out a section of the database and save only the data within the window as a SYMbol. The data can be on more than one layer. If you use the SYMbol/SAVE feature, you will make the entire database into a SYMbol. SYMbolS are stored on your SYMbol default drive.

NOTE: See CAD System Concepts (Chapter 2), and SYMbol Commands (Chapter 5, Section 12) for a complete description of saving and loading SYMbolS and some "plan ahead" steps, before writing SYMbolS to a SYMbol file. The INFO section has information on the SYMbol default drive.

**Origin:**

When you save a SYMbol, you will be asked to pick an "origin". This is the same as a reference point in other commands such as MOVE/WIN/IDEN, or COPY/WIN/IDEN. It is the point used to reference the SYMbol in the file.

**EXIT:** Press Esc key

**PROCEDURE:**

Select COPY and MAKE SYM. You will see this prompt:

To save a window area as a Symbol pick LL and UR pts.

Position the cursor at the lower left, (LL), point of a WINdow that encloses the object to be saved. Press Button #1. Repeat this step for the upper right, (UR), point on the "window". The objects will now be highlighted. You will see this prompt:

Proceed with Symbol save? Y/N

Select YES or NO by typing **Y** or **N**. If you choose Yes, you will see:

Btn1 - select origin

---

Choose the origin by positioning the cursor on the data and pressing Button #1.

HINT: It is a good idea to establish a convention for placing the origin of SYMBols in the same place each time. For instance, if you always choose the lower left corner, this will be easier to remember when placing the SYMBol.

You will see this prompt:

Filename:

Type in a SYMBol name, (such as "DESK"). Press the (Return) key.

Your SYMBol will now be saved to the SYMBol default drive (established on the INFO Page). When saving the SYMBols, CADDRAFT will give it the three letter extension, .SYM. The only time you will need to use the .SYM extension is when you are using the FILE/ERASe feature.

NOTE: The data that the SYMBol was created from is still hard data. VIEW/REDO will restore the original color. To load the SYMBol, use SYM/LOAD.

---

**SUBCOMMAND: WIN****PURPOSE:**

With WIN, a box or WINDOW of data is designated and copied. The objects to be copied must be on the active layer.

**EXIT:** Press Esc key

**PROCEDURE:**

Select COPY, and WIN. You will see this prompt:

Btn1 - Select LL & UR points

This means to choose the lower left, and upper right of the WINDOW using Button #1.

You will see this prompt:

Btn1 - Select point to copy from  
Btn2 - Release

Now, choose the reference point and press Button #1. You will see this prompt:

Btn1 - Select point to copy to  
Btn2 - Release

Move the cursor to the new location and press Button #1 to place the objects. Continue to use Button #1 to place objects or use Button #2 to end the copying process.

---

**SUBCOMMAND: IDEN****PURPOSE:**

Selects multiple items and copies them as a group.

**EXIT:** Press Esc key

**PROCEDURE:**

Select COPY and IDEN. You will then see this prompt:

Btn1 - add selected items  
Btn2 - stop adding

Position the cursor at any point on the first object to be copied. Press Button #1. The object will be highlighted.

Now repeat the step for multiple objects. When you have IDENTified all the objects that you wish to copy, press Button #2. You will see this prompt:

Btn1 - Select point to Copy from  
Btn2 - Release

Choose a Reference Point, Press Button #1. You will see this prompt:

Btn1 - Select point to Copy to  
Btn2 - Release

Move the cursor to the entry point at the new location. Press Button #1 again. The entire group of objects will be copied to the new location.

Press Button #2 to release the objects.

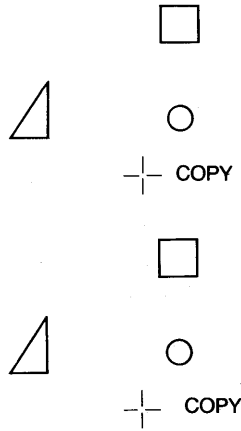
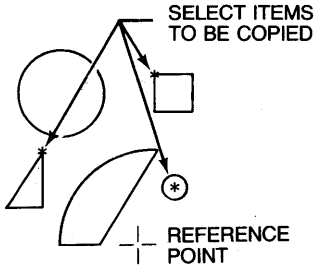

IDENTify a group and  
select the reference point

and COPY





# Section 10

**COMMAND:** EDIT

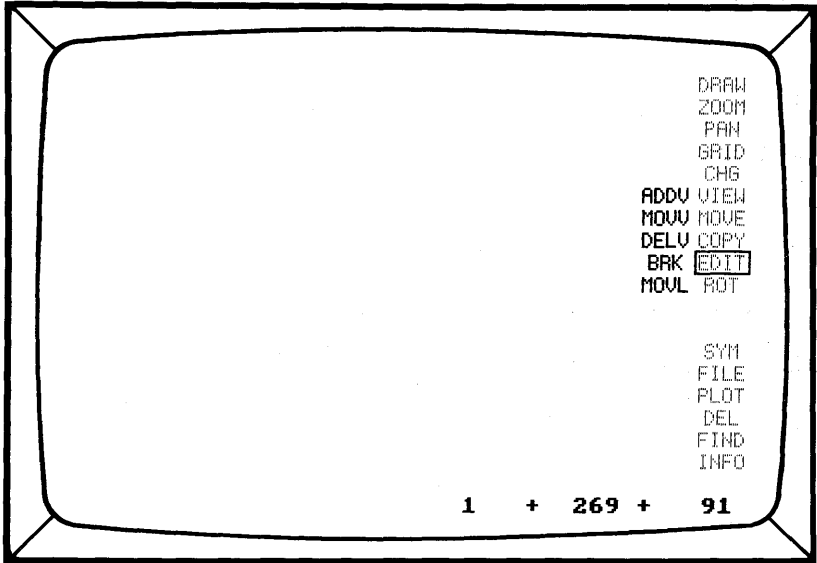

**PURPOSE:**

Edits existing design items

**EXIT:** Move cursor to next selection

**PROCEDURE:** The EDIT command edits design data by adding, moving, or deleting vertices, and by stretching, shrinking and breaking lines, circles and arcs.

When you select an item to edit, the active layer will automatically become the layer the item was drawn on.

**SUBCOMMAND:** ADDV**PURPOSE:**

Adds vertices to an existing line segment.

**EXIT:** Press Esc key

**PROCEDURE:**

Select EDIT and ADDV. You will see this prompt:

Btn1 - Select line

Position the cursor on the point on the line where an additional vertex is to be added. Press Button #1. The object will be highlighted. You will see this prompt:

Btn1 - position new vertex  
Btn2 - freeze

Press Button #1. ( The line can be "rubberbanded" in real time by moving the cursor and holding down Button #1 until the desired location is reached.)

When the new vertex is in the desired location, press Button #2.

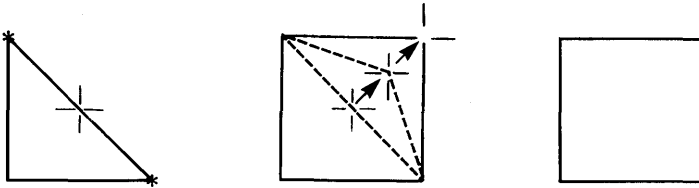

You can add a vertex point by using ADDV

---

**SUBCOMMAND: MOVV****PURPOSE:**

Moves existing vertices to new locations.

**EXIT:** Press Esc key

**PROCEDURE:**

Select EDIT and MOVV. You will see this prompt:

Btn1 - Select vertex

Position the cursor on the vertex you wish to move. Press Button #1. You will see this prompt:

Btn1 - position vertex  
 Btn2 - freeze

Move the cursor to the new position.

Press Button #1. (The line can be "rubberbanded" by holding down Button #1 until the desired location is reached.)

When the new vertex is in the desired location, press Button #2.

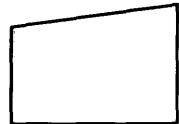
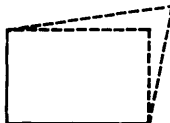
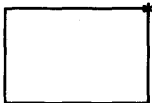

You can move a vertex point by using MOVV

---

**SUBCOMMAND:** DELV**PURPOSE:**

DELetes vertices from line segments.

**EXIT:** Press Esc key

**PROCEDURE:**

Select EDIT and DELV. You will see this prompt:

Btn1 - Select vertex

Move the cursor to the vertex to be deleted. Press Button #1. The object will be highlighted and then deleted.

When the vertex is deleted, a straight line will automatically be drawn between the two adjacent vertices.

For example, a rectangle will be changed to a triangle when one vertex is deleted.

Press Button #2 when you are finished to enter the edited data. If you do not press Button #2 the changes are not entered. VIEW//REDO will return the drawing to its original state.

**NOTE:** DELV marks the vertex as deleted. If an undelete (DEL/UNDO), is performed later, the edits will be UNDONE and the original lines will be redrawn. Use FILE/PACK to completely remove the deleted vertex from the database. This will also insure the maximum space available for data storage.

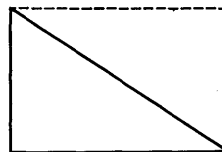
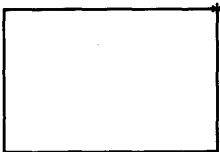

You can delete a vertex with DELV

---

**SUBCOMMAND:** BRK**PURPOSE:**

Breaks a LINE, CIRCle or ARC

**EXIT:** Press Esc key

**PROCEDURE:**

Select EDIT and BRK. You will see this prompt:

Btn1 - Select first break point

Move the cursor to a the first point where the line is to be broken. Press #1. You will see this prompt:

Btn1 - Select second break point  
Btn2 - Cancel

Move the cursor to the second point where the line is to be broken and press #1 again.

**IMPORTANT:** Design items modified by using BRK cannot be restored to their original shape by using VIEW/REDO. This, like DRAW/ERASE, is a permanent deletion of data.

Circles require a third point to identify which segment to remove. You will see this prompt:

Btn1 - Select side to delete  
Btn2 - Cancel

LINEs, CIRCles and ARCS can be broken with BRK.

**SUBCOMMAND: MOVL****PURPOSE:**

Moves one line segment in a rubberband mode.

**EXIT:** Press Esc key

**PROCEDURE:**

Select EDIT and MOVL. You will see this prompt:

Btn - Select line

Move the cursor to any point on a line. The entire line, including connected vertices, will be highlighted. You will see this prompt:

Btn1 - position line  
Btn2 - freeze

Move the line segment, using the cursor, until it is positioned correctly. Press Button #2 to enter.

If the cursor is moved and digitized at different places, the line segment moves, keeping the same length and angle it originally had, and the two adjoining segments are stretched or shrunk to match it.

Press Button #2 to release the line segment.

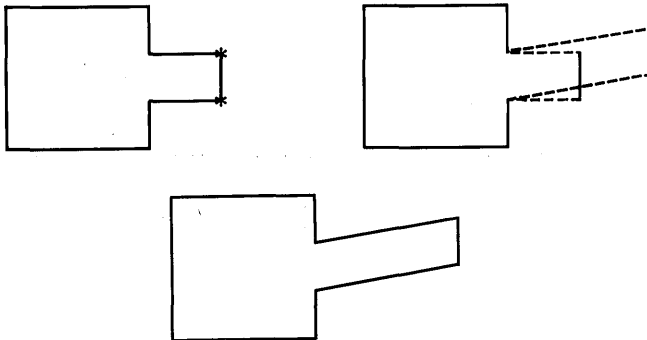

You can move a line segment with MOVL

# Section 11

**COMMAND:** ROTate

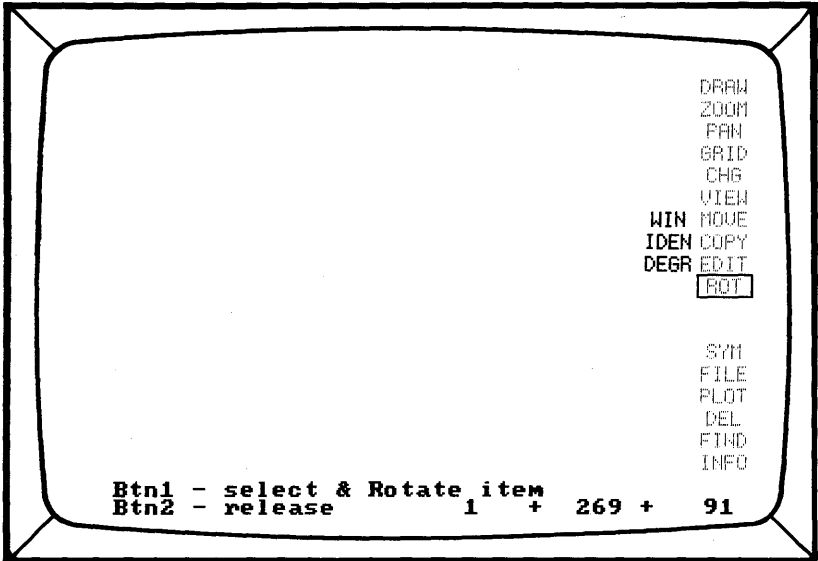

## PURPOSE:

Changes the angle of objects

Single design items with connected vertices, windowed design items, or groups of unconnected design items can be rotated around a user defined point at either 90 degree increments or user defined degree increments.

CADDRAFT will move to the layer the items are DRAWn or placed on for simple design items. For ROTating groups of items using WIN or IDEN, you must first move to the active layer.

To reverse rotation, press **R** on the keyboard.

## Reference Point:

In WIN and IDEN, you will be asked to select a "reference point". This point will be the point around which the object ROTates. For instance, if you are rotating a desk, you would choose a reference point, like the lower left corner. The desk will then rotate around this corner. Think of it as the "handle" of your design.

TEXT and SYMBols (with WIN or IDEN) can be rotated either around their origins or a user defined reference point. When either of these items are contained in a drawing, you will see one or both of the following prompts:

Rotate SYM about (O)rg or (R)ef pt?  
 Rotate TEXT about (O)rg or (R)ef pt?

ROTated items may look somewhat distorted on the screen depending on the degree of rotation. This does not affect the accuracy of the plot.

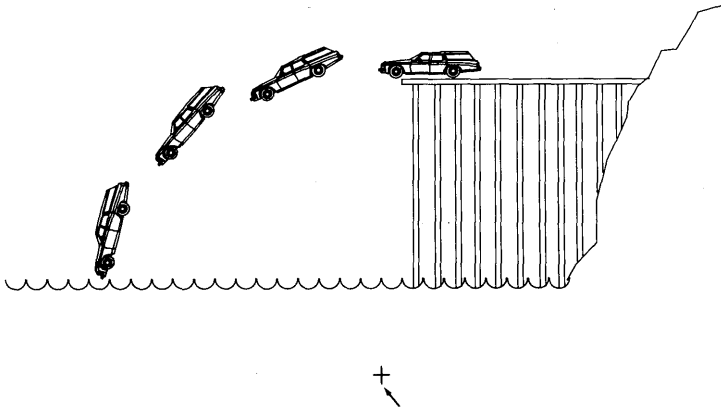

Symbols rotating around a reference point

**EXIT:** Press Esc key.

**PROCEDURE:**

Select ROTate to rotate simple shapes with connected vertices. You will then see this prompt:

Btn1 - select & Rotate item  
 Btn2 - release

Select the item to be rotated. To select a symbol, you must select the origin. Press Button #1. The object will be highlighted.

Each time you press Button #1, the object will rotate 90 degrees about the selected vertex. Press Button #2 to release the object. To rotate by any other degree (in 5° increments) choose ROT and DEGR.



---

NOTE: If an object is ROTated several times at odd degree increments, some distortion might occur.

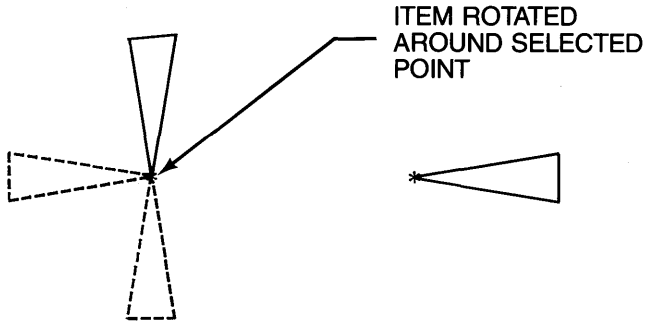

Simple Shapes can be rotated 90 degrees by using the ROTate command alone

**SUBCOMMAND: WIN****PURPOSE:**

This command creates a box or WINDOW around objects to be ROTated. Objects must be on the active layer.

**EXIT:** Press Esc key

**PROCEDURE:**

Select ROT, and then WIN. You will see this prompt:

Btn1 - Select LL & UR points

Enter the lower left and upper right of the WINDOW using Button #1. You will see this prompt:

Btn1 - Select point to rotate about

Choose a reference point to rotate around. Remember, text or SYMBOLS can rotate around either their origin or a user defined reference point.

Use DEGR to change DEGREE of rotation.

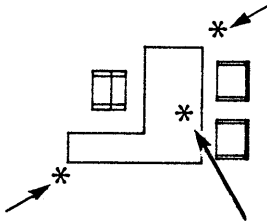

Select lower left, upper right and reference point

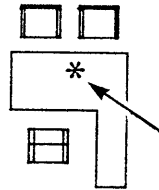

Then ROTate

---

**SUBCOMMAND: IDEN****PURPOSE:**

Selects multiple objects to be ROTated as a group.

IDEN will allow you to choose simple design shapes with either one vertex or connected vertices, one-by-one, then rotate them as a group. The objects must be on the active layer.

**EXIT:** Press Esc key

**PROCEDURE:**

Select ROT and IDEN. You will then see this prompt:

Btn1 - add selected items  
Btn2 - stop adding

Select the items to be included on the group using Button #1. When you have IDENTified all the objects that you wish to ROTate, press Button #2. You will then see the following prompt:

Btn1 - Select point to rotate about

Move the cursor to the reference point. Press Button #1. You will be prompted:

Btn1 - Rotate  
Btn2 - Release

If you press Button #1 the entire group will be rotated by the specified number of degrees about the selected point. If you continue to press Button #1 the rotation will continue. Press Button #2 to release and enter the rotation.

---

Use ROT/DEGR to change the DEGRee of rotation.

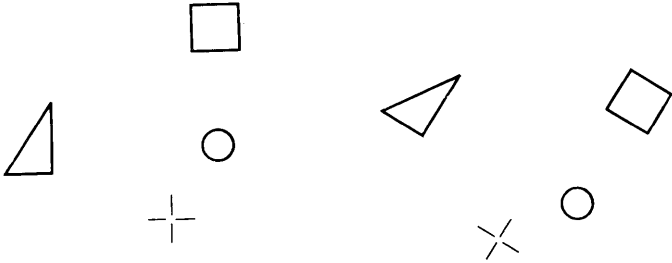

IDENTify a group and select  
the reference point

Rotate

---

**SUBCOMMAND:** DEGR**PURPOSE:**

Permits objects to be ROTated by a specified number of degrees in 5 degree increments.

**EXIT:** Press Esc or (Return) key

**PROCEDURE:**

Select ROTate and DEGRee. You will then see this prompt:

Current angle =  
Enter new angle (180 max)

Type in your choice of degree, such as **15** degrees and press the (Return) key.

Now select ROT (alone), or ROT with WIN, or IDEN. Follow the screen prompts to rotate.

To reverse the order of rotation, Press **R** on the keyboard.

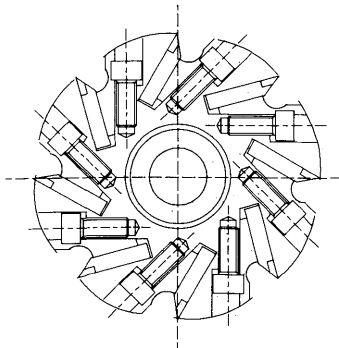

You can ROTate by any 5 Degree increment.



# Section 12

**COMMAND:** SYMbol

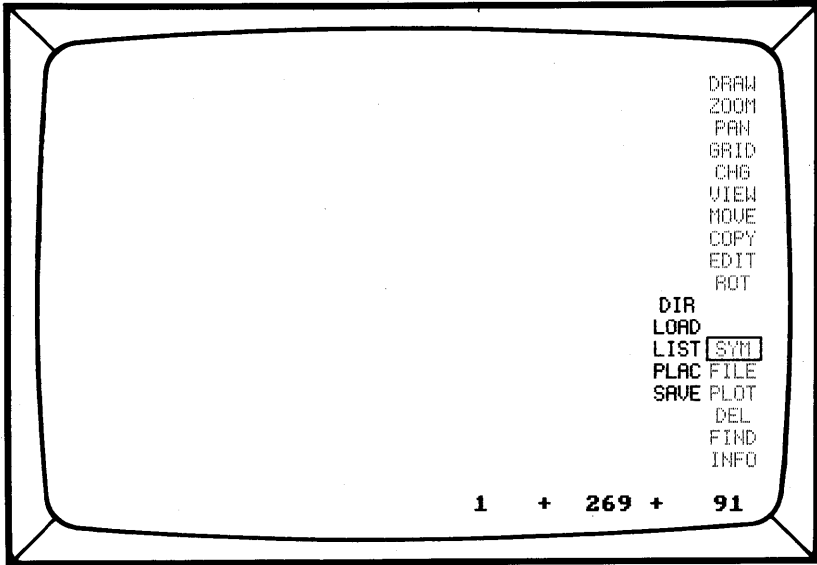

**PURPOSE:**

Create, Place and Edit SYMBols

**EXIT:** Move cursor to next selection

**PROCEDURE:**

Any object that appears in multiple places on a drawing, or in more than one drawing, can be created once, stored as a SYMbol, and placed any number of times in several different drawings.

Several Main Menu Commands are involved in the use of SYMBols. Following is a brief outline. You should be familiar with DRAW, COPY, and INFO before attempting SYMBols. SYMBols are also described in the CAD System Concepts section of this manual.

- Create the SYMbol using DRAW commands.
- Set the SYMbol default drive in INFO.
- Store the SYMbol using COPY/MAKE SYM or SYM/SAVE commands.
- Load the SYMbol using SYM/LOAD.
- Change the active SYMbol using SYM/LIST.
- Place the SYMbol using SYM/PLAC.
- Edit the SYMbol using SYM/LOAD for EDIT.

---

## Origin

The "Origin" of a SYMBol is its reference point or handle. It is the point by which the SYMBol is stored, retrieved and placed.

The use of SYMBols saves repetitive drawing and saves computer memory and storage. Even though a SYMBol may have many vertices, once it is stored as a SYMBol, it is referenced by only one point, its origin. Any change to a SYMBol is reflected in each subsequent use of that SYMBol. It is a good idea to designate a block of layers just for symbols. That way, you won't have any surprises when you are trying to view or print a single layer full of SYMBols on a complicated design. Also, avoid creating and placing SYMBols on a layer that contains hard data.

## Plotting SYMBols

SYMBols will plot with the plotter pen designations assigned to the layers they are created on.

## SYMBols and Database Units

CADDRAFT stores all files in Database Units, including SYMBol files.

CADDRAFT can convert your SYMBols to the appropriate DBUs for your design. If you attempt to insert a SYMBol that was created in Mils into a database that was created in feet and inches, CADDRAFT will prompt you to rescale one or the other.

## Editing SYMBols

You may want to change or combine SYMBols from time to time. You can edit a SYMBol through SYM/LOAD/EDIT. You can convert existing SYMBols to a different Database Unit by using the program CPSCALE. (For information on CPSCALE see the SYMBol Conversion section of this manual.)



---

**SUBCOMMAND:** DIR**PURPOSE:**

Lists all or selected SYMbol files.

**EXIT:** Press Esc or (Return) key

**PROCEDURE:**

Select the SYM and DIR commands. You will see this prompt:

Drive for symbol directory (A-G)?

If you have a dual floppy disk drive system, your SYMbol default drive should be **B:**.

Type in the letter of the disk drive the SYMbol is stored on. If it is stored on the SYMbol default drive (see INFO), press the (Return) key. You will see:

SYMbol prefix? (1 or 2 characters)

If you wish to isolate a group of SYMBols that begin with the same letter(s) follow this prompt. If you wish to see the entire directory, press the (Return) key.

CADDRAFT will display the list of all SYMBols, (each one followed by .SYM). It will look something like this:

```

Drive for symbol directory (A-G)? b
Symbol prefix? (1 or 2 characters)
DOOR-R .SYM CH-EXEC .SYM DOOR-L .SYM
CH-SIDE .SYM PLANT .SYM CONF-B .SYM
D-SEC .SYM

Present symbol default drive is b
Enter new default (A-G) or SPACE BAR

```

You can also change the "SYMBOL default drive" while the SYMBOL directory is displayed. See the prompt at the bottom of the page:

```

Present symbol default drive is
Enter new default (A-G) or space bar

```

If you want to change the default drive for SYMBols at this point, type in the new default drive letter **B:**. This will automatically update the Symbol Default Drive option (#7) in the INFO page.

Press the space bar to return to the menu page.

---

**SUBCOMMAND: LOAD****PURPOSE:**

Loads a SYMbol from disk into memory

You can LOAD up to 120 SYMbols at one time. A total of 3000 symbol vertices can be placed in a drawing file at one time.

**EXIT:** Press Esc or (Return) key

**PROCEDURE:**

Select SYM and LOAD. You will see this prompt:

Filename:

Type in the filename of the SYMbol, (i.e. CREDENZA), then press the (Return) key. You will then see this prompt:

Load for (P)lace or (E)dit?

(P)lace will allow you to load one or a group of SYMbols for placement on the design using the (P)lace command.

To select the SYMbol for placement, use SYM/LIST.

Type **P** to (P)lace the SYMbol. You will then see this prompt:

Filename:

---

You can now type in another SYMbol name or press (Return). Refer to the SYM/PLAC command for procedures on PLACing the SYMbol.

Type **E** to (E)dit the SYMbol. You will see this prompt:

Existing database will be overwritten Continue? Y/N

Type **Y** to LOAD your SYMbol for Edit or **N** if you don't want your database overwritten.

If you choose (E)dit, the SYMbol will be displayed on the monitor with an X at the origin.

(E)dit will allow you to make changes to the SYMbol. If you choose this option, the changes you make to the SYMbol will override the old SYMbol if you store the SYMbol under the same name. You can keep both copies by giving the EDITed SYMbol a new name.

**NOTE:** If your SYMbol is a different scale (in Database Units) than your current screen, you will be prompted accordingly and allowed the option of loading or not loading the SYMbol. You can rescale the SYMbol using CPSCALE.

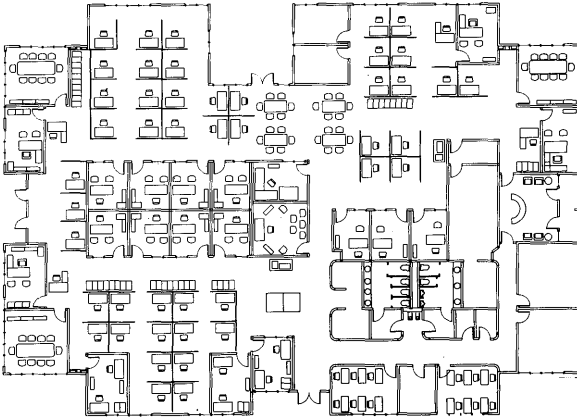

Most of the furniture and fixtures in this drawing are SYMbol.

**SUBCOMMAND: LIST****PURPOSE:**

LISTs the library of SYMBols that are currently loaded into the active drawing file.

**EXIT:** Press Esc key

**PROCEDURE:**

Select SYM and LIST. CADDRAFT will display the names of all the SYMBols in the SYMBol library that are currently active (ready to place) and the number of times that each SYMBol has been placed in your design. It will look something like this:

```

SYMBOL INFORMATION
NAME          #
[ch-side]    0
door-r       0
door-l       0
ch-exec      0
plant        0
d-sec        0
conf-b       0

Active symbol is conf-b
BUTTON #1 to change active symbol,  BUTTON #2 to return

```

To choose a SYMBol for placement, move the cursor until it "boxes" the name of the SYMBol you want to place and press Button #1. CADDRAFT will automatically go to SYM/PLACe. You will see this prompt:

Btn1 - place symbol Active Sym:

**SUBCOMMAND:** PLACe**PURPOSE:**

PLACes SYMBols into your design file.

PLACe is the final step in the SYM, LOAD, LIST, PLACe sequence.

**EXIT:** Press Esc key

**PROCEDURE:**

Select SYM and PLAC.

Move the cursor to the position where the origin of your SYMbol is to be PLACed. Press Button #1.

You may place multiple copies of this SYMbol by repeatedly moving the cursor and pressing Button #1.

---

**SUBCOMMAND: SAVE****PURPOSE:**

Stores the active drawing file as a SYMbol or stores an EDITed SYMbol

**EXIT:** Press Ésc key

**PROCEDURE:**

Select SYM and SAVE. You will see this prompt:

Btn 1 - select origin

Move the cursor to the chosen origin of the SYMbol. You will see this prompt:

Filename:

Type in the name of the SYMbol (up to 8 characters). The SYMbol will be SAVEd on the Symbol default drive set in INFO.

**NOTE:** To save an object, or a WINdow of objects as a SYMbol and exclude other design data in the database, use COPY/MAKE SYM.





# Section 13

## COMMAND: FILE

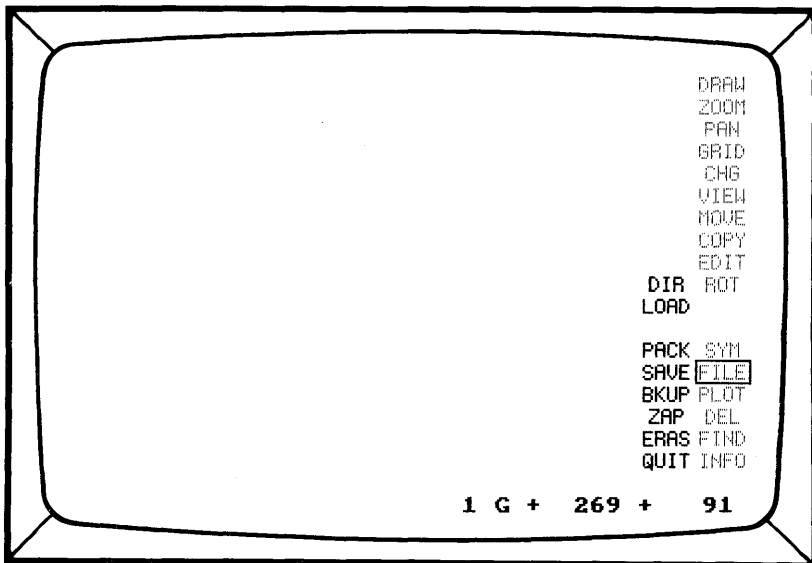

### PURPOSE:

Saves, loads, and deletes Database Files.

**EXIT:** Move cursor to next selection

### PROCEDURE:

Select FILE. Choose a submenu option.

The FILE submenu is your file manager. It allows you to recall a file from the disk to the screen (LOAD), and permanently store (SAVE) (BKUP) Database Files. You can see a DIRectory of your files with the DIR command. It also permanently removes deleted data from the database through the PACK command. The ZAP option clears the database and screen for you and QUIT exits to the operating system. Finally, you can eliminate files from the disk with the ERAS command (including .SYM and .DBF files).

NOTE - FILE commands use the default drive specified in INFO.

---

**SUBCOMMAND: DIR****PURPOSE:**

Displays a DIRectory of Database Files on a specific disk drive.

**EXIT:** Press Esc or (Return) key

**PROCEDURE:**

Select FILE and DIR. You will see this prompt:

Drive for file directory (A-G)?

Type in your drive letter or press the (Return) key for the default drive.  
You will see this prompt:

File prefix? (1 or 2 characters)

You can isolate files by typing the first character, or two characters of the file name(s).

This gives you the option to view specific files that have been designated with any one or two letter combination. To display all files, press the (Return) key. The system will display all Database Files stored on that drive.

CADDRAFT adds “.DBF” at the end of each file to distinguish them as Database Files.

---

The directory looks like this:

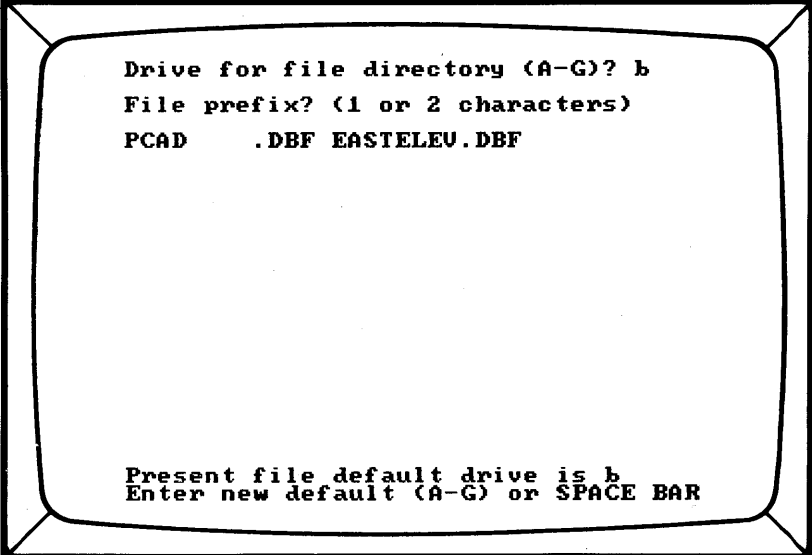

Drive for file directory (A-G)? b  
File prefix? (1 or 2 characters)  
PCAD .DBF EASTELEU.DBF

Present file default drive is b  
Enter new default (A-G) or SPACE BAR

---

**SUBCOMMAND:** LOAD**PURPOSE:**

LOADs a Database File from disk into memory.

**EXIT:** Press Esc or (Return) key

**PROCEDURE:**

Select FILE and LOAD. You will then see this prompt:

Filename:

Type in the disk drive the file is SAVEed on followed immediately by the name of your Database File, for example, **B:PCAD**, then press the (Return) key.

If the file is stored in the default drive as set in INFO, you do not need to type in the disk drive letter. You will see the message:

Loading from Disk:

CADDRAFT will LOAD the file into the memory and display it on the monitor.

You can stop the draw of a file you have loaded by pressing the spacebar.

---

**SUBCOMMAND: PACK****PURPOSE:**

Removes DELETED objects permanently from the Database File and compresses, or PACKs the remaining data to its smallest size.

If you have DELETED any design items while building your design, they will remain stored in memory although they are not displayed on the monitor if they have not been SAVED.

**EXIT:** Move cursor to next selection

**PROCEDURE:**

Select FILE and PACK. The PACKing will be performed and CADDRAFT will return you to the menu.

PACK permanently removes deleted objects from the Database File.

NOTE: FILE/SAVE automatically PACKs the database before saving.

---

**SUBCOMMAND: SAVE****PURPOSE:**

Copies the current design file to disk.

**EXIT:** Press Esc or (Return) key

**PROCEDURE:**

Select FILE and SAVE. When prompted type in the name of your file (i.e.,DESIGN1), and press the (Return) key.

CADDRAFT will PACK the data and SAVE it on the default disk drive as established in INFO.

---

**SUBCOMMAND:** BKUP**PURPOSE:**

Backs UP a FILE by making a copy of the Database File (.DBF) and all associated SYMbols (.SYM).

**EXIT:** Press Esc or (Return) key

**PROCEDURE:**

Select FILE and BKUP. You will then see this prompt:

Backup to which drive:

Type in the disk drive letter of your destination. (On a two floppy system this will always be A:) You will see this prompt:

Database Filename:

Type in the name of the file, and press the (Return) key. You do not need to type in the source drive letter or the extension.

SYMbols must be stored on the SYMbol default drive currently established in INFO in order to be copied with the file.

BackUP is normally used to transfer a design to a floppy disk for archival storage. Not only is the database saved, but a copy of each required symbol file is saved as well.

---

**SUBCOMMAND:** ZAP**PURPOSE:**

Clears the existing Database (and monitor display) from memory.

**EXIT:** Press Esc or (Return) key

**PROCEDURE:**

Select FILE and ZAP. You will see this prompt:

Clear database? Y/N

If you want to clear the database, type **Y**. CADDRAFT will clear all layers of data and display a blank work area and the menu on the monitor. The screen will have the center at 0,0 and a Display Ratio of 1 to 1.

If you do not wish to clear the database, press **N**.

**IMPORTANT** - ZAP does not erase the file from disk. However, edits that are not **SAVEd** before using ZAP will be lost.



---

**SUBCOMMAND:** ERASe**PURPOSE:**

ERASes any DOS File.

**EXIT:** Press Esc or (Return) key

**PROCEDURE:**

Select FILE and ERASe. You will see this prompt:

Name of file to erase? (with extension)

Type the disk drive letter followed immediately by the name of the file to be ERASed, and the extension.

B:DESIGN1.DBF

B:S-CHAIR.SYM

and press the (Return) key.

CADDRAFT will ERASe the file from the directory.

**SUBCOMMAND:** QUIT**PURPOSE:**

Exits CADDRAFT

**EXIT:** Press Esc or (Return) key

**PROCEDURE:**

Select FILE and QUIT. You will see this prompt:

Quit Job ? Y/N (Is drawing saved?)

Type **Y** or **N**.

**HINT:** You may also type **Ctrl C** on the keyboard to exit from CADDRAFT at any time without going to the FILE/QUIT option.

# Section 14

## COMMAND: PLOT

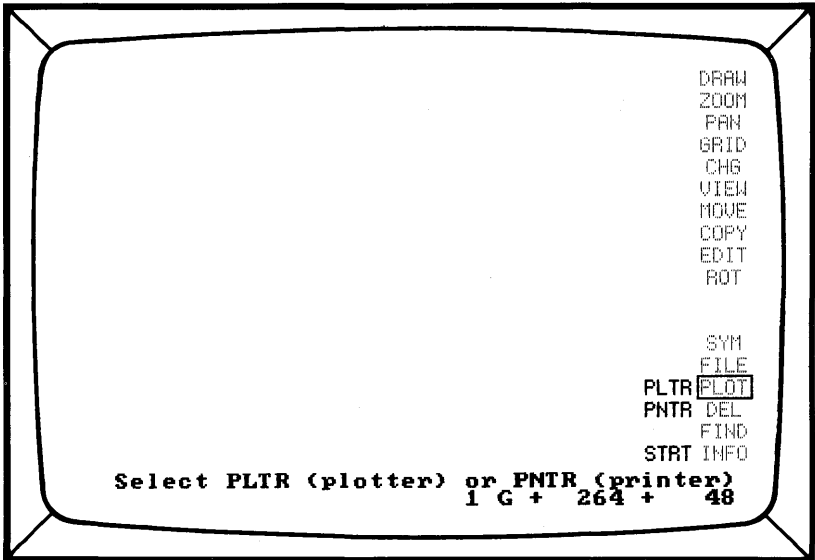

### PURPOSE:

Creates plots or prints from the current job

**EXIT:** Press Esc or Button #2

### PROCEDURE:

PNTR or PLTR are the submenu options for directing the output to a dot matrix Printer or Pen Plotter.

Your plotter must be one of the ones supported by CADDRAFT. See the back of this manual under "Hardware and Peripherals".

Your printer must have graphics capability to actually produce a hard copy.

When the desired plot or print is larger than one sheet of paper, the system will allow you to break the drawing into sections.

Only data that is displayed on the monitor will plot or print, so be sure all data is showing before you begin.

---

NOTE: You will be prompted to load the CADDRAFT SYSTEM B disk in Drive B.

## Plot Scale

Your plot or print scale can be whatever you like within these limits: It must use one of these words or abbreviations:

IN	INCH	INCHES
FT	FOOT	FEET
'	"	
MI	MIL	MILS
M		
CM		
MM		

Plot Scale can be in whole numbers, fractions or decimals. All of these would be acceptable plot scales:

Measured on Plotter		Represented in Database
1/4IN	=	1FT
.25IN	=	1FT
5CM	=	1M

---

**SUBCOMMAND:** PLTR**PURPOSE:**

Directs output to a plotter.

**IMPORTANT:** Before using the PLTR option, be sure the INFO page has been updated to show the correct Plotter (Parameter #14) and Plotter Default Drive (Parameter #15). Refer to the INFO command section for additional information.

When plotting, any color can be used for any layer through the layer set up in the INFO page. Wide lines are not filled (unless you are using an HP7475, HP7580 or JSC plotter).

**EXIT:** Press Esc or (Return) key

**PROCEDURE:**

Select PLOT. You will see this prompt:

Select PLTR (plotter) or PNTR (printer)

Select PLTR. You will see this prompt:

FILE SHOULD BE SAVED BEFORE CONTINUING!  
Hit A to abort PLOT, or any key

If your file is not saved, go to FILE/SAVE at this point and save it. If your file is saved, press any key.

Your next prompt(s) will be according to the type of plotter you have chosen in the INFO menu.

If you have a dual floppy drive system, you should load the CADDRAFT PLOTTER INTERFACES disk in the default Plotter Drive (See INFO) and press any key.

You will need to answer the PLOT questions according to the type of plotter you have and how many colors you will be using.

When you have answered these questions, you will see this prompt:

Enter scale <CR>, then STRT

---

## Scale

At this point you will need to decide your output scale.

For instructions in the use of the SCALE option, turn to the beginning of the PLOT section.

When you have chosen a scale, a box will appear beginning in the lower left of your monitor. This represents the size of the plotter paper. CAD-DRAFT will compute this based on the plotter you have installed in the INFO page.

You can change the scale easily by using the X key to reselect PLTR and entering another scale. When you are satisfied with the size of the box or the plot scale, select STaRT.

## Single Sheet Plotting

If you want your design to be plotted on a single sheet of paper, change the scale until the design fits within the box. Then select STRT to STaRT the output. You will see this prompt:

Btn1 - move plot window;  
Btn2 - pick # of plots, P to start

You can adjust the box to fit your drawing at this point. Position the cursor where you want lower left corner of box and press Button #1. You can reposition the box in this manner until it is positioned correctly. It will encompass all or a portion of your drawing. The plotter will only plot the enclosed area.

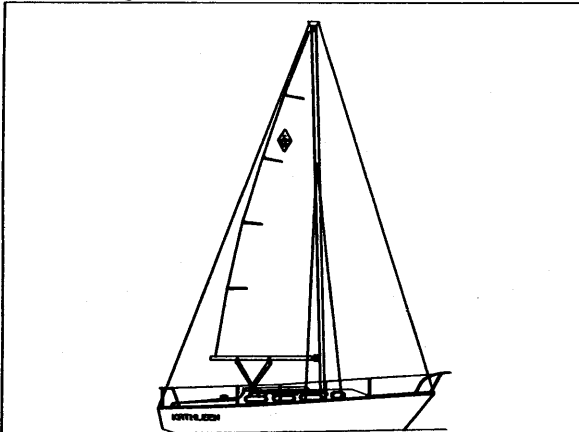

---

When you are finished, select **P**. You will see this message:

Plotting will require\_\_\_\_ sheet(s)  
Continue (Y or N)?

Type **Y** to start the output process.

You will see this prompt:

Plug PLOTTER into COMM Port #  
Turn on Plotter and press any key.

Press any key, you will see this prompt:

Include messages and outline box?  
Y for yes, or any key

If you wish the scale to be plotted on the sheet, (i.e. 1/4 inch = 1 foot) and a frame drawn around the drawing, press **Y** at this point. If not, press any key. Subsequent prompts will depend on the type of plotter you are using.

### Multiple Sheet Plotting

If you have a large design and would like to plot the design in multiple sheets, choose a scale then select **STaRT**.

Next move the cursor to the lower left portion of your design. Press **But-ton #1**. The box will now appear. If you want to reposition the box, do so by moving the cursor to a new location and press **Button #1**.

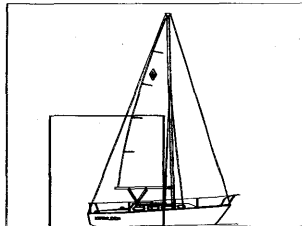

Now move the cursor to the upper right portion of the design and press Button #2. CADDRAFT will overlay multiple boxes on your design to show you the number and contents of each plot.

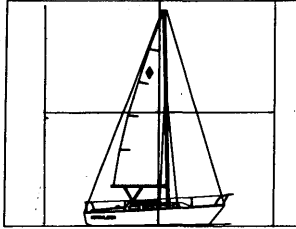

You can move all the boxes simultaneously by using Button #1.

When you are finished, select **P**. You will see this message:

Plotting will require \_\_\_\_ sheet(s)  
Continue (Y or N)?

Type **Y** to start the output process.

You will see this prompt:

Turn on PLOTTER then press any key

You will see this prompt:

Include messages and outline box? Y for yes, or any key

If you wish the scale to be plotted on the sheet, (i.e. 1/4 inch = 1 ft.), and a frame drawn around the drawing, press **Y** at this point. If not, press any key.

You should be plotting. If you are not, check the following:

1. Is the plotter turned on?
2. Is it attached to the right port on the computer?
3. Is CADDRAFT configured properly for the output device? (See INFO)
4. Is the paper installed in the device?
5. Are plotter pens installed?



---

**SUBCOMMAND:** PNTR**PURPOSE:**

Directs output to a dot matrix printer with graphics capability.

On a dot matrix printer, colors are plotted as gray contrast, and wide lines are filled.

**EXIT:** Press Esc or Button #2

**PROCEDURE:**

Select PLOT. You will see this prompt:

Select PLTR (plotter) or PNTR (printer)

Select PNTR. You will see this prompt:

Enter scale, <CR>, then STRT

**Scale**

At this point you will need to decide your output scale. Type in the SCALE, following the rules in the PLOT introduction.

When you have chosen a scale, a box will appear beginning in the lower left of your monitor. This represents the printer paper. You can now see whether you need to print in multiple sheets or whether one sheet will be sufficient.

You can change the scale easily by using the X key to reselect PNTR to enter another scale.

When you are satisfied with the size of the box, or the print scale, select STRT.

---

## Single Sheet Printing

If you want your design to be printed on a single sheet of paper, change the scale until the design looks like it will fit within the box. Then select STRT to start the output. You will see this prompt:

Btn1 - move plot window;  
Btn2 - pick # of plots, P to start

Now, position the cursor where you want the lower left corner of the box to be and press Button #1. You can reposition the box in this same manner until it is positioned correctly. It can encompass all or a portion of your drawing. The plotter will only plot the enclosed area.

When it is positioned correctly, press **P**.

Type **Y** to start the output process or **N** to stop. If you type **Y** you will see this prompt:

Turn on PRINTER then press any key

Turn on the Printer. Press any key. You will see this prompt:

Include messages? Y for yes, or any key

Choose either option. If you choose yes, CADDRAFT will print your scale on the output.

## Multiple Sheet Printing

If you have a large design and would like to print the design in multiple sheets, choose a scale then select STaRT.

Next move the cursor to the lower left portion of your design. Press Button #1. The box will now appear. If you want to reposition the box, do so by moving the cursor and pressing Button #1.

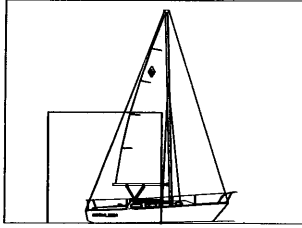

Now move the cursor to the upper right portion of the design and press Button #2. CADDRAFT will overlay multiple boxes on your design to show you the number and contents of each plot.

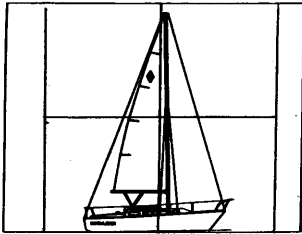

You can move all the boxes simultaneously by using the cursor control and Button #1.

When you are finished, press **P**.

Type **Y** to start the output process. You will see this prompt:

Turn on PRINTER then press any key

Turn on the Printer. Press any key. You will see this prompt:

Include messages? Y for yes, or any key

Choose either option. If you choose yes, CADDRAFT will print your scale on the output.

You should be printing. If you are not, check the following:

1. Is the printer turned on?
2. Is it attached to the right port on the computer?
3. Is the paper installed in the device?

---

# Section 15

## COMMAND: DEL

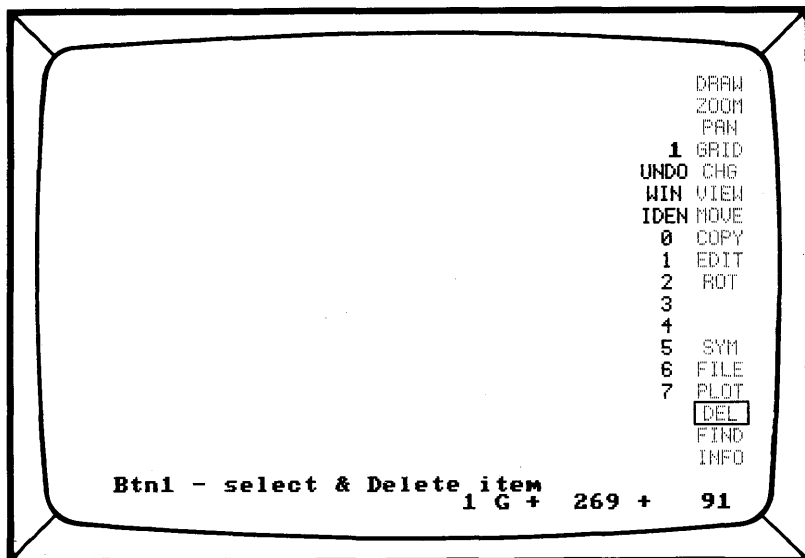

### PURPOSE:

DELEtes data and SYMbols

This command allows you to DELEte data and SYMbols from your design and to delete entire layers.

The number on top tells you which layer is active. The other numbers are for selecting a layer to delete with a digit command.

**EXIT:** Press Esc key.

### PROCEDURE:

DELEte, used without a submenu option, will remove single design items with connected vertices. It will DELEte groups of items using WIN and IDEN.

DEL used alone will automatically move to the layer the object is placed or drawn on. DEL with WIN or IDEN will require the prior step of changing to the layer the objects are placed or drawn on.

NOTE - DELEted items can be restored to the screen with DEL/UNDO. This is because DELEte does not remove the data from the Database; it simply removes it from the monitor. To completely remove the data from your database, you must select the PACK or SAVE options.

**PROCEDURE:**

Select DEL. You will see this prompt:

Btn1- select & Delete item

Move the cursor to any point on the object or to the origin on a SYMbol. The layer the object is drawn or placed on will become the active layer. Press #1. The object is DELETED.

DElete used alone will also DElete an entire layer. Choose DEL. Choose a layer number by moving the cursor over the numbers 0-7 to give a two digit command. (02, 03, 07 would be acceptable). Press Button #1 to confirm each digit. You will see this prompt:

Delete all data on layer \_\_\_\_? Y/N

Type in **Y** or **N**. If you choose YES or **Y**, the entire layer will be deleted.

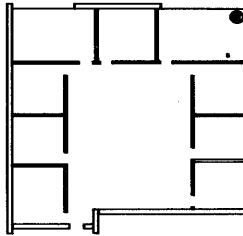
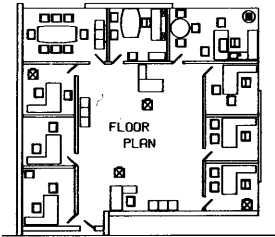

Choose an object, Press Button #1. The item is deleted.

If all of the Furniture is on one layer, which is DELETED only the outer walls and partitions will appear on the screen

---

**SUBCOMMAND: UNDO****PURPOSE:**

Undeletes all DELETED objects on a selected layer.

If you inadvertently or deliberately DELETED data on a layer, the data is still stored in memory, (unless you PACKED or SAVED your file after the DELETED) although the data is not shown on the monitor.

**EXIT:** Press Esc key.

**PROCEDURE:**

Select DELETED and UNDO. You will see this prompt:

Select layer to undelete

Choose the layer the data was DELETED from by a two digit command (i.e. 07 for layer #7 ). For instance, if the data is on layer 2, move the cursor to 0 and press Button #1 then move the cursor to 2 and press Button #1 again. Press Button #2 to confirm. The data that was previously DELETED on that layer is now restored.

**NOTE:** This will not work if the data has been PACKED or SAVED.

**HINT:** An effective way to make a copy of all data on another layer is to use the CHANGe command to transfer the data from one layer to another, (CHANGe layers),and then UNDO the original layer.

**SUBCOMMAND: WIN****PURPOSE:**

A box or WINDOW of data on the active layer is designated and then DELETED.

**EXIT:** Press Esc key

**PROCEDURE:**

Select DEL, and then WIN. You will see this prompt:

Btn1 - Select LL & UR points

This means to choose the lower left, and upper right of the WINDOW using the cursor control and Button #1.

The items to be DELETED will be highlighted. You will be prompted:

Btn1 - delete  
Btn2 - cancel

Press Button #1 and items in the WINDOW will be deleted.

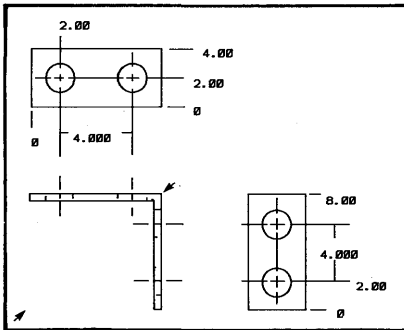

Select lower left and upper right

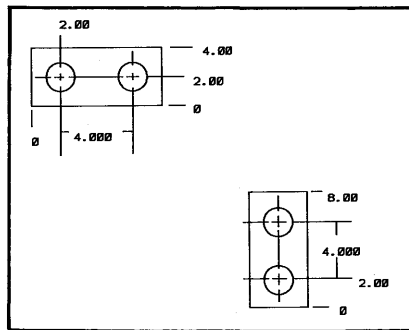

Then DELETE

**NOTE:** The data can be restored by using DEL/UNDO



---

**SUBCOMMAND: IDEN****PURPOSE:**

Selects multiple items on the active layer and deletes them as a group.

**EXIT:** Press Esc key.

**PROCEDURE:**

Select DEL and IDEN. You will then see this prompt:

Btn1 - add selected items  
Btn2 - stop adding

Position the cursor at any point on the first object to be deleted. Press Button #1. The object will be highlighted.

Now repeat the step for multiple objects. When you have IDENTified all the objects that you wish to delete, press Button #2 to stop IDENTifying and Button #1 to DElete.

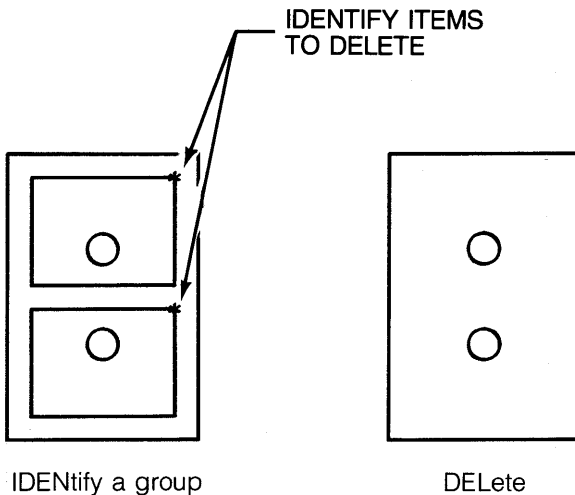

NOTE: Data can be restored using DEL/UNDO



# Section 16

---

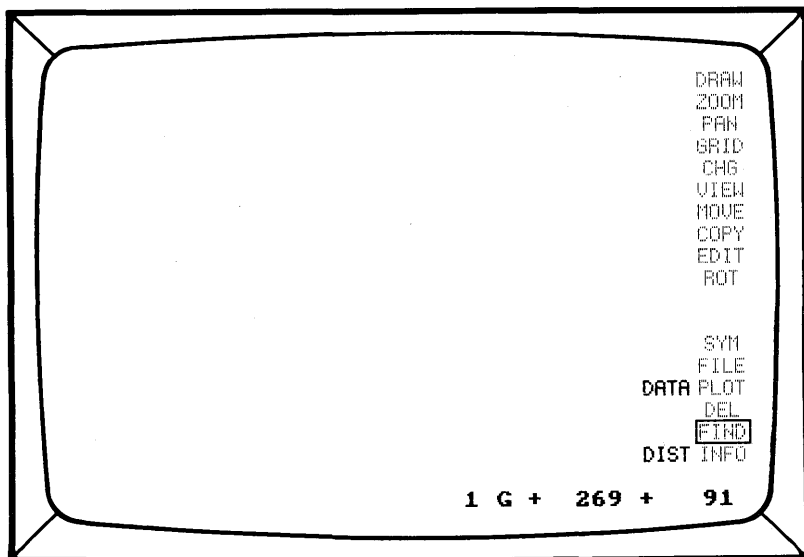
**COMMAND: FIND**

**PURPOSE:** The FIND command gives you information about your drawing, i.e. what layer an object is on, TEXT size and ROTation. It also does mathematical computations displaying distance.

**EXIT:** Move cursor to next selection

**PROCEDURE:**

Select FIND. Choose a submenu option.

All of the FIND command results are displayed in the Database Units set in Parameter #6 in INFO. In other words, the numbers will be displayed according to the Database Unit set in INFO #6.

---

**SUBCOMMAND: DATA****PURPOSE:**

Finds important DATA

Displays information about your data, such as layer number, text size and rotation, symbol name, etc. It may be used for either hard data or symbols.

**EXIT:** Press Esc key or Button #2

**PROCEDURE:**

Select FIND and DATA. You will then see this prompt:

Btn1 - Select item for layer display

Move the cursor to any point on the object that you require additional information about. Press Button #1. CADDRAFT will display the following:

For Symbols:

1. Layer number.
2. SYMbol name.
3. Total number of Symbols placed.
4. Rotation.

For Text:

1. Text size.
2. Rotation.
3. Layer number.
4. Text number.

For Data:

1. Layer number

---

**SUBCOMMAND:** DIST**PURPOSE:**

Measures the distance between two points that you select.

**EXIT:** Press Esc key

**PROCEDURE:**

Select FIND and DIST. You will be prompted:

Distance from...select first point

Move the cursor to the first point and press Button #1.

You will be prompted:

To...select second point

Move the cursor to the second point and press Button #1.

Locate the points using Button #1.

CADDRAFT will display the DISTance and the number of Database Units between the two points.

After you enter the points, you can continue using Button #1 to check the distance from the first point or you can use Button #2 to enter a new first point.



# Section 17

## COMMAND: INFO

```

Your system is currently configured as follows:

 1 Display mode - COLOR                21 Grid # 1 X = 3 Y = 3
 2 Active layer - 1                    22 Grid # 2 X = 6 Y = 6
 3 Display ratio = 1                  23 Grid # 3 X = 12 Y = 12
 4 X-step size = 6                    24 Grid # 4 X = 24 Y = 24
 5 Y-step size = 6                    25 Grid # 5 X = 48 Y = 48
 6 1 database unit = 1"              26 Grid # 6 X = 120 Y = 120
 7 Symbol default drive - b           27 Grid # 7 X = 10 Y = 10
 8 File default drive - b             28 Grid # 8 X = 25 Y = 25
 9 Plot from comm port # 2           29 Grid # 9 X = 50 Y = 50
10 Active grid # - 3                  30 Grid # 10 X = 100 Y = 100
11 Grid is NOT DISPLAYED
12 Grid lock is ON
13 Input device (Comm. 1 always) - Mouse Systems Mouse (MOUS1)
14 Plotter (Currently comm. 2 ) - not selected
15 Plotter default drive - C
16 Cursor definition                  Amount of memory = 512 K-bytes
17 Text size information              Number of layers = 7
18 Layer information                  Active file is no file
19 Restore default configuration      Window origin X = -131
20 Save as new default                Y = -91

BUTTON #1 - select
BUTTON #2 - return to COMMAND menu

```

### PURPOSE:

Displays the system and job parameters

The INFO command is an important menu option which enables you to tailor the default settings for specific jobs. It also enables you to set the desired default configuration for CADDRAFT.

### PROCEDURE:

To use this command choose INFO from the main CADDRAFT menu. Next, move the cursor over the Parameter # you wish and press Button #1. Button #2 will return you to the main CADDRAFT or command menu.

After you choose an option, you will be prompted to make choices. Sometimes these will be YES or NO questions. If so, you will see a prompt like this:

YES NO

---

Move the cursor over the choice and press Button #1, or type **Y** or **N** from the keyboard.

Sometimes the Parameter you choose will require the input of a number(s). If this is the case, you will see something like this:

0123456789+-.C or 000000

You can move the cursor over the numbers, pressing Button #1 after each choice, or you can input numbers from the keyboard and press the (Return) key. To CANCEL a command, move the cursor to the C and press Button #1, or type **C** from the keyboard.

### To Create New Default Settings

INFO Menu options become default settings by choosing Parameter 20 and typing Y.

### To Tailor Settings for a Specific Design

You can create a temporary job setting by pressing Button #2 after the parameters are changed. This will be saved with your file when you choose FILE/SAVE, but will not change the default settings.

### To Restore the Default Setting

Choose Parameter 19. This will "restore" the default INFO page.

### Parameter #1 - Display Mode

This parameter tells CADDRAFT whether you are using a monochrome monitor or a color monitor.

You will need a color/graphics card with either option.

### Parameter #2 - Active layer

This setting lets you decide which layer you usually want to begin your work on, or your default layer. You can also use this feature to change the active layer while you are working, although the CHG command is usually used for this.



---

**Parameter #3 - Display Ratio**

This setting allows you to determine the screen display ratio of your drawing. For instance, if you set the display ratio at "1", your screen will reflect one design Database Unit per one screen pixel image. If you have a setting of 2, your screen will reflect one Database Unit per two screen pixel images, .5 would be half of a pixel image and so forth. This can be in whole numbers or decimals (1.3654).

The number on the INFO page will change as you adjust the screen display using the ZOOM and VIEW commands.

**Parameter #4 - X-step size =****Parameter #5 - Y-step size =**

The "step size" is the number of Database Units the cursor will move in the X or Y direction using the keyboard arrow keys. This works only when the GRID lock is off. For instance, if the step size is 1, the cursor will move 1 Database Unit per keystroke. If the step size is 10, the cursor will move 10 Database Units per keystroke.

The X and Y step sizes do not have to be the same.

If you are working with a design with many Database Units per pixel image (for instance, when you are ZOOMed out to see a whole drawing), you may find that the keyboard arrows will have to be pressed several times for every movement of the cursor on the screen. Each pixel on the screen will contain a number of world coordinates.

When not GRID locked and ZOOMED out (many world coordinates/pixel) each pixel may represent a range of world coordinates. When using a mouse, CADDRAFT will constantly recompute the world coordinates in the pixel to the center of the world coordinate range. If you want the screen to reflect the exact world coordinates displayed, use the X key and space bar in place of the mouse buttons for point entry.

The cursor movements from a mouse or other input device will not be affected by the step size setting.

**Parameter # 6 - 1 Database Unit =**

With this setting, you will determine the type of measurement you will use and the smallest degree of accuracy.

The Database Units you define here will be reflected in screen measurements when you use DRAW; in the FIND command when you want to check DISTANCE; and in PLOT when you are ready for a hard copy of your design.

There are a total of sixty possible DBU settings. Each setting displays the DBU #, DBU value, description (Fraction, Decimal, Metric etc.) and the display units (FEET, INCH, FT-IN). The first forty are preset for your convenience to commonly used units. The last four definitions are the DBU settings used in CADDRAFT version 1.35. All of these units are permanently set.

To choose one of these, move the cursor over the setting and press Button #1. Then select CHAnGe. You will see this screen:

USER DEFINABLE DATABASE UNITS											
#	DBU	Description	#	DBU	Description	#	DBU	Description	#	DBU	Description
1	1	Unit	21	.002"	Decimal	INCH	41	User	Definable		
2	1"	Fraction	22	.001"	Decimal	INCH	42	User	Definable		
3	1\2"	Fraction	23	.0005"	Decimal	INCH	43	User	Definable		
4	1\4"	Fraction	24	1.0	Decimal	FEET	44	User	Definable		
5	1\8"	Fraction	25	.1	Decimal	FEET	45	User	Definable		
6	1\16"	Fraction	26	.01	Decimal	FEET	46	User	Definable		
7	1\32"	Fraction	27	.005	Decimal	FEET	47	User	Definable		
8	1\64"	Fraction	28	.001	Decimal	FEET	48	User	Definable		
9	1\128"	Fraction	29	1.0	Decimal		49	User	Definable		
10	1\128"	Fraction	30	.5	Decimal		50	User	Definable		
11	1.0"	Decimal	31	.1	Decimal		51	User	Definable		
12	.5"	Decimal	32	.05	Decimal		52	User	Definable		
13	.25"	Decimal	33	.01	Decimal		53	User	Definable		
14	.125"	Decimal	34	.005	Decimal		54	User	Definable		
15	.1"	Decimal	35	.001	Decimal		55	User	Definable		
16	.0625"	Decimal	36	.0005	Decimal		56	User	Definable		
17	.0625"	Decimal	37	1mm	Metric		57	1"	FT-IN (1.35)		
18	.05"	Decimal	38	.1mm	Metric		58	0.1"	TENTHS (1.35)		
19	.01"	Decimal	39	.01mm	Metric		59	0.001"	MILS (1.35)		
20	.005"	Decimal	40	.001mm	Metric		60	1	UNITS (1.35)		

Current DBU is # 57  
 BUTTON #1 to select, BUTTON #2 to return to INFO menu

If you need a type of measurement that is different from the preset measurements, or if you want one of the existing measurements to have a smaller or larger tolerance, or degree of accuracy, you can define your own. Settings 41 - 56 allow you to define any unit and type of display you desire.

For instance, if the DBU is set to 1 inch and you find that you need greater precision, you can choose the degree of accuracy to be any fraction or decimal value that you like.

---

Besides the smallest unit of accuracy, other user defined features are the ability to choose the type of display (fractions, decimals etc.), the unit designation such as: inch, in, feet, foot, ft, ' , " , mm, cm, M , etc. and the format of the display.

To set user definable units, select the number of the DBU you wish to define (DBU numbers 41 through 56). Then select REDEFINE and enter the following DBU information:

1. DBU NAME - This is up to six characters and is usually set to the DBU value. The DBU NAME is what appears after Parameter #6 in the INFOrmation page.
2. Description - The description might include information about the display type, the display format and the level of precision (Display Accuracy). It can be a maximum of 14 characters.

For example, units #2 - #10 use a FRACTIONAL display in FT and INches such as 20' 1/8" (CADDRAFT will automatically display the lowest common denominator of the fractions). DBU description #7 includes a Display Accuracy of 1/8. In this case, one DBU = 1/16" but the display will round to 1/8" (useful for dimensioning etc.)

3. 1 DBU = - This will be your smallest level of tolerance or your smallest degree of accuracy. This is for your information, and is an optional Step. It could look like this:

1 DBU :1CM  
 1 DBU :1In  
 1 DBU :1/4IN  
 1 DBU :2MILS

#### 4 - 9 Definition -

This is where you will let CADDRAFT know your measuring system. The first definition, #4 is the most important. This is the Database Unit you will build the rest of your measuring system around. The rest of the numbers can be multiples or fractions of this DBU.

4. Definition :primary Database unit

all of these would be acceptable:

4. Definition :1=1"	4. Definition :1 = .125"
4. Definition :1 = 1CM	4. Definition :1=1/8"
4. Definition :1=1 FOOT	4. Definition :1=1/4 Inch

The subsequent definitions (5-9) are for additional measurements. All of these will be in multiples or fractions of your smallest unit of measurement, or 1 DBU. For instance, if 1 DBU = 1/4 Inch then you would need to let the system know that 48 DBU's = 1 Ft., otherwise, drawings exceeding a foot would still be represented in inches (i.e. 72 3/4 inches)

A File for Metric Measurements could look like this:

```
DBU NAME           :METRIC
Description        :CM to METER
1 DBU              :1 CM
definition         :1=1CM
definition         :10=1DM
definition         :100=1M
definition         :
definition         :
```

Error Messages:

Use Parameter #20 to set this as a default DBU setting.

If you see this error message:

ERROR IN DEFINITION

Check the following:

1. Missing equal sign (=) or unit name
2. Definitions are not in ascending order
3. Unit name is repeated
4. Zero is defined
5. No Database Unit name

Note: Although the size of the "world" remains the same no matter what the Database unit, the available drawing area may expand or contract according to the smallest level of accuracy chosen.

For instance, if you choose 1 inch as the smallest level of tolerance (1 DBU=1"), you will have 65,535 inches in each (X and Y) direction, or just over a mile. But if you choose 1/2 inch as the smallest degree of accuracy, you will cut this distance in half, or have about a half a mile of drawing area.

### **Parameter #7 = SYMBOL default drive**

With this setting you choose the disk drive that CADDRAFT will place your SYMBols on and retrieve them from.

---

In normal system configurations, your SYMBol default drive will be **B:** on a two drive system.

**Parameter #8 - FILE default drive=**

With this setting you choose the disk drive that CADDRAFT will place your files on and retrieve them from.

In normal system configurations, your file default drive will be **B:** on a two drive system.

**Parameter #9 - Plot from Comm Port #**

You need to let CADDRAFT know which communications port you will attach the plotter to. "Comm ports" are the connectors on your computers that communicate with your output device such as your plotter, and your input device, such as your mouse. Your minimum system configuration requires that you have at least one RS-232, or asynchronous, port to run your input and output device.

If you are also using a plotter, it is recommended that you install an additional RS-232C Module.

Your input device must be on Communications port #1. You can also use this port for the output device by changing cables when you are ready to plot.

However, if you have an input and output port, the output, or plotter port, will be on Comm. port #2.

See the back of this manual, "Hardware and Peripherals" for more information on communications devices.

**Parameter #10 - Active Grid #**

The default grid can be set here. This will be one of the GRIDs in Parameter settings 21-30.

For instance, if Grid #3 is 6x6 and you choose this as the active grid, this will be the grid that is displayed unless changed through the GRID settings or through the INFO page.

**Parameter #11 - Grid is #**

The two options are: NOT DISPLAYED

DISPLAYED

---

This is a default setting. If you always want your program to start with a displayed grid, you would set Parameter #10 to DISPLAYED.

### Parameter #12 - Grid Lock is

The two options are: ON            OFF

If you want your program to come up with the Grid Lock on, set ON. If you want your program to come up with the Grid Lock off, set OFF.

### Parameter #13 - Input device #

This parameter will be one of the input devices supported by CADDRAFT. Check the back of this manual under "Hardware and Peripherals" for a complete list.

If you are using more than one input device, you will need to change this setting as you change devices.

### Parameter #14 - Plotter

This parameter will be set for one of the plotters that runs on an RS-232 port that is supported by CADDRAFT. Check the back of this manual under "Hardware and Peripherals" for a complete list.

If you are using more than one output device, you will need to change this setting when you change devices.

### Parameter 15 - Plotter Default Drive

In this Parameter, you will tell the program which drive you will be inserting your plotter disk in when you are ready to plot. On a two disk drive system, this must be **A:**.

### Parameter 16 - Cursor Definition

This setting allows you to choose between three cursor types.



The Cross



The X

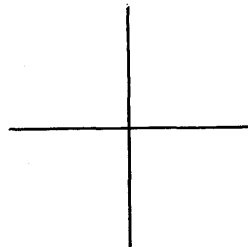

The whole Screen

---

Follow the screen prompts to choose the size of the cursor, the size of the center, the type, and the color. The size of the gap must be set using odd numbers.

### Parameter 17 - TEXT Size Information

Through this command, you can pre-set 15 of your most commonly used text sizes to recall with a single keystroke command (numbers 1 through 15). TEXT sizes can be from 1 to 1500 Database Units.

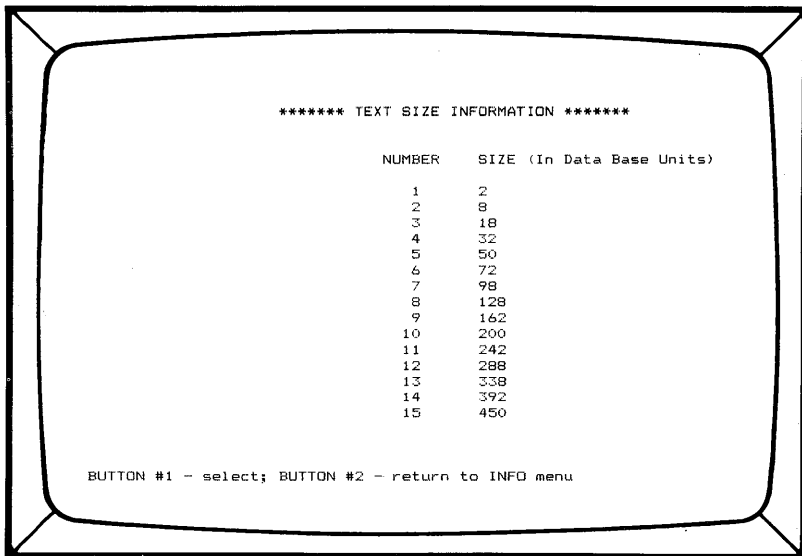

```
***** TEXT SIZE INFORMATION *****  
  
          NUMBER      SIZE (In Data Base Units)  
          1           2  
          2           8  
          3          18  
          4          32  
          5          50  
          6          72  
          7          98  
          8         128  
          9         162  
         10         200  
         11         242  
         12         288  
         13         338  
         14         392  
         15         450  
  
BUTTON #1 - select; BUTTON #2 - return to INFO menu
```

TEXT can be changed while drawing by following the TEXT command prompts. The TEXT size changes made this way will also appear on the INFO page.

It is important to remember that TEXT is used in a drawing by the number which precedes the TEXT size on the INFO page. If the TEXT size that corresponds to this number is changed, the size of the TEXT in the drawing will also be changed.

See the TEXT section under the DRAW commands for more information on TEXT.

## Parameter 18 - Layer information

You will see this screen:

#	Type	%	Pen	Info
[ 1]	——	0	1	
2	——	0	2	
3	- - -	0	3	
4	- - -	0	4	
5	——	0	5	
6	——	0	6	
7	- - -	0	7	

Viewed layers are blocked  
 BUTTON #1 - select; BUTTON #2 - return to INFO menu

Layer information tells you:

- Layer numbers and layers viewed
- Line type and color
- Percent of the layer used
- Plotter pen designation
- Descriptive INFORMATION about each layer

It is possible to have up to 7 layers with CADDRAFT.

Use the cursor and Button #1 to select the layer you wish to change. You will then be prompted for the following:

**COLOR:** Mindset gives you a choice of 16 colors. If you have a monochrome monitor they will all be the same color.

**LINE TYPE:** A line can be a solid, dashed, dotted, or dash-dot.

**VIEW LAYER:** Viewed layers will be blocked when you call up the layer Screen. They can be turned on and off through this menu option or through the VIEW/LAY command.



---

**PEN NUMBER:** Plotter pen designation. You can have any color available on your plotter on the printed copy. In other words, if layer is listed on your screen as a dotted yellow line, and you have assigned that to pen #1 on your plotter, it will plot the color of pen #1 on the plotter.

**INFOrmation:** You may enter a brief description of each layer (maximum 8 characters), such as: WIRING, PLUMBING, WALLS, etc.

You will also see a % displayed at the top of the layer column. This represents the data storage of the layer. Each layer can hold up to 1,000 vertices. Remember, CADDRAFT only sees and stores vertices even though you see a whole design. The % full lets you know how much data has been stored on that layer.

### **Parameter 19 - Restore default configuration**

This option will bring back your default setting if you have modified the INFO page for a particular drawing.

### **Parameter 20 - Save as new default**

With this parameter, you can save your current INFO page as the default. The default is the INFO page that will be active when the system is booted or when you choose Parameter 19.

### **Parameters 21 - 30 - Grid**

This parameter allows the user to set 10 grid sizes for later recall.

The grids are set in Database Units with X and Y coordinates. These should reflect consistency with the Database Units chosen for the total picture.

For instance, a 10X10 grid for a drawing with Data Base Units in tenths of an inch would be one inch between gridpoints.

A 12x12 grid with one Database Unit equal to one inch would be one foot by one foot.

The grids are recalled by Grid #1-10 through the GRID menu.

---

To change the grids, move the cursor to the grid to be changed (21-30) and press Button #1. You will first choose the X grid size, then the Y grid size using the cursor control and mouse buttons. To save your new grid size as a default, choose Parameter 20.

Other items listed on the INFO page include:

- amount of memory
- number of available layers
- active database file
- current window origin.

# Section 18

---

## Keyboard Key Commands

### Exiting Commands

Most CADDRAFT commands can be exited by pressing the (Return) key or the ESC key. Commands can also be exited by moving the cursor to a new command and pressing Button #1 on the mouse. Commands in INFO are exited by pressing **C** and return or moving the mouse over the C and pressing Button #1.

### Keyboard Commands in Response to Prompts:

Some of the keyboard keys are used for answers to prompts. These sometimes work in conjunction with the input device by having you give single keystroke answers to prompt such as: **Y** for Yes, **P** for Print, **S** for Save.

You are also asked for numeric entries from time to time to reflect world coordinates, plot scale, text number, angles, etc. Type the entry and press (Return).

### Keyboard Commands Equivalent to Menu Commands

Some other commands are duplicate menu commands. These are for convenience and are generally faster than moving the mouse to the menu items. These are:

D = Turns Grid Display On/Off. This is also found in the GRID submenu option DISP

G = Grid Lock On/Off. This is also found in the GRID submenu option LOCK

Ctrl G = Grid Information. This duplicates information found in the INFO page and GRID menu

---

S = Step Size. This sets the distance the cursor will move in Database Units when moved from the directional arrow keys on the keyboard (when the grid lock is off). This is also set through the INFO page.

### **Keyboard Commands Which Enhance Menu Commands**

Some keyboard commands modify or enhance a menu command engaged through an input device, such as a mouse. These are:

R = Reverses rotation when used with ROT/DEGR command.

3 = Allows 3 point ARCS and CIRCles when used with these DRAW subcommands

It is helpful to memorize these keyboard commands as they are not given as prompts in CADDRAFT.

### **Keyboard Commands Equivalent to Input Device Functions**

Some keyboard commands can be used for cursor movements and in place of buttons on an input device, such as a mouse. These are:

X - Same as Button #1 on the mouse.

Spacebar - Same as Button #2 on the mouse.

Directional arrow keys - moves the cursor up, down, left, or right.

### **Other Keyboard Commands**

Ctrl K - This keyboard command allows you to turn off the "click" on the Mouse Systems Mouse.

Ctrl I - This command will redraw the main menu if the menu options become disarrayed.

Ctrl C - Aborts job

---

# SYMBOL SCALING PROGRAM

There are three optional symbol libraries which can be purchased with CADDRAFT 1.40. These are the Architecture, HVAC and Electronics libraries. The Architecture and HVAC libraries were created at 1 DBU = 1/4 inch. The Electronics library was created at 1 DBU = 1 mil.

If you wish to convert (scale) these symbols to different DBUs to make them consistent with your drawing DBUs, use the symbol scaling program, CPSCALE, found on your System B disk. This program may also be used to convert (scale) symbols you have created using CADDRAFT.

After your software is installed according to the directions in the previous sections, you can scale your symbols. It is a good idea to first make a copy of the symbols you have already created with CADDRAFT. Use the MS-DOS COPY command and copy the symbols in their existing DBUs, so you may recall them later.

NOTE: Your symbol must be translated to 1.40 format to use CPSCALE. If it has not been translated, see CPTRANS in the Getting Started Chapter.

## **CPSCALE**

With a two floppy disk drive system, place your System B disk in drive A and the disk with your symbols to be scaled in drive B. With A> on the screen, type:

CPSCALE, and press (Return)

You will see this information:

This program scales 1.40 symbol databases.

Recognizes (upper and lower case): FT IN MILS M CM MM only

Enter drive letter for symbol directory (A,B,C,D,E,F or G):

---

Enter the proper drive letter, no (Return) is necessary. At the bottom of the screen you will be asked:

Do you want symbol directory to be displayed?

A yes response will show you the total number of symbols on the selected drive and their names. You will then be asked to enter the name of the symbol to be scaled. Type in the symbol name. At this point you may elect to change the name of your symbol which is to be scaled. To change a symbol name, type in the new name and press (Return). If no name change is desired, just press (Return).

When your symbol has been scaled you will see the following prompts at the bottom of the screen.

Old DBU number: DBU description Do you want to scale symbol \_\_\_\_  
by using new DBU?

This tells you the DBU which was used in creating the symbol and asks if you would like to convert it to a new DBU value from the 60 DBU selections available in 1.40. If you want to select a new DBU, type **Y**. The symbol will be scaled and stored on disk under the new name and the symbol directory will be updated. If you want to select a new DBU, type **N**. The system displays the following prompt:

Enter scaling factor:

Type the scaling factor (i.e. 2.5) and press (Return). The symbol will be scaled and stored on the disk under the new or original name you have selected. The symbol directory will also be updated.

After the symbols are scaled, the program asks:

Continue.....(Y/N)?

If you type **Y**, the Scaling Program continues. If you type **N**, the program returns you to DOS.

# Chapter 6

---

## A DOS Primer

This primer outlines the basics of Mindset MS DOS--it covers most of what you need to know about DOS to use CADDRAFT:

For more information on MS-DOS, see your Introductory Guide to MS-DOS and MS-DOS Reference Manual.

---

### DOS Prompt

The > is the DOS prompt. It tells you that it's your turn to enter information. It also tells you that DOS has completed a previous command and is waiting for you to enter another command from the keyboard.

The letter preceding the > (either A or B) designates default drive--the drive that DOS will access to save a file, load a file, or execute some other command unless you specify another drive in your command.

---

### Changing Disk Drives

To change the default drive, you enter the new designation letter followed by a colon. For example:

```
A> (original prompt)
A>B: (new drive designation) (Return)
B> (new prompt)
```

---

### Rules for Using DOS

#### Upper or Lower Case .

When specifying a drive or typing a filename, you can use either upper or lowercase letters.

#### Files and Filenames

Each file on a diskette must have a unique name.

Filenames enable DOS to find specific information quickly and easily.

---

Filenames may be from one to eight characters, optionally followed by a period and an extension of up to three characters. The characters in a filename can be:

the letters of the alphabet,

the numbers 0 through 9, or

these special characters: \$ # & @ ! % { } ' ' -

Examples of filenames with extensions are:

FLORPLAN.NO1  
DESIGN.FEB  
PCAD.2

If a filename includes an extension, you must use both parts when telling DOS about that file.

## Filenames You Cannot Use

Do not use the following sequences of characters in your filenames: CON, AUX, COM1, COM2, LPT1, PRN, LPT2, LPT3, or NUL. The use of these sequences in filenames will cause unpredictable behavior in your computer system.

---

## Function Keys

Refer to your Mindset Operation Guide, Introductory Guide to MS-DOS, and MS-DOS Reference Manual to determine how the function keys on your keyboard work with MINDSET MS-DOS.

---

## To Stop a Command

As soon as you press (Return) after entering a command, DOS begins to execute the command. To stop the operation in progress, press the **Ctrl** and **C** keys simultaneously.

---

## To Start DOS Again

If you want to reset DOS and start over, put your MS-DOS diskette into drive A. Press **ALT** and **RESET** simultaneously.



---

## Formatting a Diskette

Formatting a diskette prepares it to store data by organizing its tracks and sectors. While formatting a diskette, MS-DOS also checks the diskette for bad tracks and sectors, builds a directory for the files you'll be storing, and--if you like--copies DOS onto the diskette.

### Caution

Do Not reformat a diskette that already contains information that you want to keep. The process of formatting erases ALL information currently on the diskette.

To format a diskette, follow this procedure:

1. With your MS-DOS diskette in drive A, insert a blank double-sided, double density diskette in drive B.
2. Type **FORMAT B:** and press (Return)

As your disk drive goes to work, the word "formatting...." appears on your screen. When formatting is complete, you're asked if you want to format another diskette. If you do, type **Y** or yes and press (Return); if not, type **N** or no and press (Return). DOS also displays the number of bytes of storage space available on the diskette and whether or not the system files have been copied (see next section).

---

## Making a Bootable Disk

If you want to be able to load CADDRAFT on a two-drive system without having first to load MS-DOS each time, you should make your CADDRAFT System Diskette A a bootable diskette. To do this, enter the following command when you format the diskette (in drive B):

### **FORMAT B:/S**

--and press (Return). DOS puts its "system" files on the diskette while formatting it. Then COPY CADDRAFT System A files onto the newly formatted diskette.

---

## Copying Diskettes

You'll want to make copies of your CADDRAFT System Diskettes as well as the data diskettes on which you store the files you create with CADDRAFT. To do so, you will need to use the COPY command.

---

You can copy:

- an entire diskette using DISKCOPY
- one file at a time, using COPY; or
- selected files, using COPY and the \* wildcard.

**Important:** Always be sure to write-protect your "source" or original diskette before copying it. Failure to do so could result in the loss or change of information if your diskettes are inserted in the wrong drive.

CADDRAFT System Diskette B is copy protected and can not be copied.

## DISKCOPY

The DISKCOPY command is used to copy entire diskettes.

To use it, make sure your MS-DOS diskette is in drive A. Then type **DISKCOPY A: B:** and press (Return). Then follow the prompt that appears on your screen:

Insert source diskette in drive A:  
Insert target diskette in drive B:  
Press any key when ready

When the copy is complete, the message

copy complete, copy another (Y/N)?

appears.

Type **N** and press (Return), then remove both diskettes.

## COPY

COPY can be used as an alternative to DISKCOPY if you want to copy only one file on a diskette. You can also use COPY to copy all or selected files on a diskette using wildcards (see next section).

To use COPY to copy a CADDRAFT file called FLORPLAN, for example, you would type:

**COPY A:FLORPLAN.DBF B:**

---

--then press (Return).

### **Wild Cards**

You can copy an entire diskette or selected files using the wild card character (\*). The \* can be used to stand for either part of a filename, the filename proper or the extension.

To copy all the files on diskette, for example, you would type:

**COPY A:\*.\* B:**

--and press (Return).

To copy all of your Data Base Files, you would type:

**COPY A:\*.dbf B:**

To copy all of your CAD files, you would type:

**COPY A:CAD.\* B:**

See your MS-DOS manual for more information.

---

## **Information**

### **Finding Out What's On a Diskette**

To find out what's on a diskette, use the DIR (directory) command. With your MS-DOS diskette in drive A and the diskette for which you want a directory listing in drive B type:

**DIR B:**

--and press (Return).

You'll see a directory listing of the contents of the diskette in drive B.

For a directory listing of the diskette in drive A, you could just type **DIR** and press (Return).

### **Storage Space and other Information**

To see how many bytes of storage space are left on a diskette in drive B, type **CHKDSK B:** --and press (Return). DOS displays a status report on the diskette in drive B, including the number of bytes free for further storage.

---

## Changing a Filename

### The RENAME Command

Using the RENAME command, you can rename a file, changing its filename, its extension, or both. Before beginning the renaming process, be sure that the diskette containing the file you wish to rename is in the active drive. Then type **RENAME**, a space, the current filename, a space, and the new filename you want. Then press (Return). For example:

**RENAME USER.MAN CADDRAFT.MAN**

--and press (Return)

In a few seconds, the prompt **A>** or **B>** will reappear on the screen. To check whether your file has been renamed, use the DIR command.

---

## Deleting Files

You can erase any file with the DEL or ERASE command.

**IMPORTANT:** Before you erase any file, be sure that you really want to delete that particular file. Once erased, a file is gone forever.

To delete a file, type **DEL** or **ERASE**, a space, the drive designation, and the filename of the file. Then press (Return). For example

**ERASE B:PCCAPS.MAN** or **DEL B:PCCAPS.MAN**

--and press (Return)

The file to be deleted need not be on the default drive. By using the drive specifier you can delete a file on any drive in the system. For example, if the prompt shows **B>**, to delete a file on drive A type:

**ERASE A:PCCAPS.MAN** or **DEL A:PCCAPS.MAN**

--and press (Return).

---

## DOS ERROR MESSAGES

Number	Message
1	NEXT without FOR
2	Syntax error
3	RETURN without GOSUB
4	Out of data
5	Illegal function call
6	Overflow
7	Out of memory
8	Undefined line number
9	Subscript out of range
10	Duplicate Definition
11	Division by zero
12	Illegal direct
13	Type mismatch
14	Out of string space
15	String too long
16	String formula too complex
17	Can't continue
18	Undefined user function
19	No RESUME
20	RESUME without error
22	Missing operand
23	Line buffer overflow
24	Device Timeout
25	Device Fault
26	FOR without NEXT
27	Out of paper
29	WHILE without WEND
30	WEND without WHILE
50	FIELD overflow
51	Internal error

---

Number	Message
52	Bad file number
53	File not found
54	Bad file mode
55	File already open
57	Device I/O error
58	File already exists
61	Disk full
62	Input past end
63	Bad record number
64	Bad file name
66	Direct statement in file
67	Too many files
68	Device unavailable
69	Communication buffer overflow
70	Disk write protect
71	Disk not ready
72	Disk media error
73	Advanced feature
74	Rename across disks
75	Path/file access error
76	Path not found -- Unprintable error -- Incorrect DOS version

# Chapter 7

---

## Hardware and Peripherals

This section describes the input and output devices you can use with your Mindset Computer.

---

### Input Devices

You can use either the Mindset Mouse, which attaches to the right side of your keyboard or choose from the other input devices described in this section which will attach to RS-232C Module #1.

---

### Monitors

CADDRAFT requires a graphics monitor.

---

### Communications Ports

All systems require at least one RS-232C module. With one RS-232C module, you will need to disconnect the mouse and connect the plotter in order to plot. The software will tell you when to do that.

With two RS-232C modules (Comm Port #1 and Comm Port #2) you can leave your input and output device plugged in at all times without having to switch connectors.

---

## Output Devices

Output can be to either a dot matrix printer with graphics capability or to a plotter. CADDRAFT comes with two plotter interfaces: Hewlett Packard 7470 and Hewlett Packard 7475. The following plotter interfaces can be ordered separately.

- IBM XY 749 - A
- IBM XY 750 - B
- Calcomp M84 - A
- Calcomp M81
- Houston Inst. DMP-29 - A,B
- Houston Inst. DMP-40 - A,B
- Houston Inst. DMP-41 - C,D
- Houston Inst. DMP-42 - C,D
- Hewlett Packard 7580
- Hewlett Packard 7585
- Gould Colorwriter DS-10
- JSC
- Nicolet Zeta

## Contents

---

### Input Devices

Mindset Mouse	7-5
Mouse Systems Mouse	7-5
GTCO Digitizer	7-6
Hitachi Tiger Pad with special EPROM	7-7
Kurta Digitizers, Series 1 and 2	7-8 7-9

---

### Plotters

Hewlett Packard 7470	7-10
Hewlett Packard 7475	7-11



---

## Printers

Epson FX-80	7-12
Epson MX-80 (with Graphics)	7-12
Epson FX-100 8-1/2 x 11	7-12
Okidata with Plug and Play	7-12
84, 92, 93, 82 A	

---

## MINDSET MOUSE

Plug your Mindset Mouse into the right side of your keyboard.

---

## MOUSE SYSTEMS MOUSE

SWITCH 1 - OFF  
SWITCH 2 - OFF  
SWITCH 3 - OFF  
SWITCH 4 - ON  
SWITCH 5 - OFF  
SWITCH 6 - OFF  
SWITCH 7 - OFF  
SWITCH 8 - OFF

The Mouse Systems Mouse comes ready to use with CADDRAFT. Simply plug it into RS-232C Module #1.

You may or may not have to calibrate the mouse by running it over the pad in a clockwise motion for about ten seconds. To verify calibration, press one of the Mouse buttons. The red L.E.D. lamp(s) on the underside should not blink. This calibration must be performed every time power is turned on.

Also, if you are using the software provided by Mouse Systems for applications other than CADDRAFT, you should first power down the Computer and reboot DOS. CADDRAFT includes its own software for operation with DOS. If you do not follow this procedure, the cursor will move in a random and erratic pattern on the monitor.

## RS232 INTERFACE FOR GTCO DIGI-PAD 5 DIGITIZING TABLET

### GTCO PORT J5 (MALE PLUG)

PIN 1  
PIN 2  
PIN 3

PIN 4 > strap  
PIN 5 >

PIN 6 > strap  
PIN 20 >

PIN 7

### PC COMM 1 PORT (FEMALE PLUG)

PIN 1  
PIN 3  
PIN 2

PIN 4 > strap  
PIN 5 >

PIN 6 > strap  
PIN 20 >

PIN 7

### SWITCH SETTINGS

#### SW1

1-ON  
2-ON  
3-ON  
4-OFF  
5-OFF  
6-OFF  
7-OFF  
8-ON

#### SW2

1-ON  
2-OFF  
3-OFF  
4-OFF  
5-ON  
6-OFF  
7-OFF  
8-OFF

#### SW3

1-OFF  
2-OFF  
3-ON  
4-ON  
5-OFF  
6-OFF  
7-ON  
8-OFF

---

RS-232 INTERFACE FOR HITACHI TABLET 2  
(Tiger Pad with Special EPROM - HDGIII BA/O)

DSW1	DSW2	DSW3
1-ON	1-ON	1-ON
2-OFF	2-OFF	2-ON
3-OFF	3-OFF	3-ON
4-OFF	4-ON	4-ON
5-OFF	5-OFF	5-ON
6-OFF	6-ON	6-ON
7-OFF	7-OFF	7-OFF
8-OFF	8-OFF	8-OFF

---

**RS-232 INTERFACE for the KURTA DIGITIZER****KURTA SERIES ONE****SW1**

1-OFF  
2-OFF  
3-OFF  
4-OFF  
5-OFF  
6-OFF  
7-OFF  
8-ON

**SW2**

1-OFF  
2-OFF  
3-OFF  
4-ON

**CABLE**

PIN 1  
PIN 2  
PIN 3  
PIN 4  
PIN 5  
PIN 6 } STRAP  
PIN 8 }  
PIN 7  
PIN 8

PIN 1  
PIN 2  
PIN 3  
PIN 4  
PIN 5  
PIN 6 } STRAP  
PIN 8 }  
PIN 7  
PIN 8

---

KURTA SERIES TWO

SW1

- 1-ON
- 2-OFF
- 3-ON
- 4-OFF
- 5-OFF
- 6-OFF
- 7-OFF
- 8-OFF

SW2

- 1-OFF
- 2-OFF
- 3-OFF
- 4-OFF

CABLE

- PIN 1
- PIN 2
- PIN 3
- PIN 4
- PIN 5
- PIN 6 \ STRAP
- PIN 8 /
- PIN 7
- PIN 8

- PIN 1
- PIN 2
- PIN 3
- PIN 4
- PIN 5
- PIN 6 \ STRAP
- PIN 8 /
- PIN 7
- PIN 8

## H P 7470

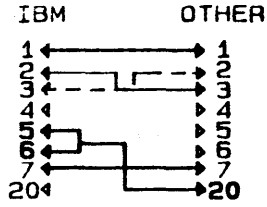

S2



S1



Y



US



B4



B3



B2



B1

SWITCH  
SETTINGS



# H P 7475

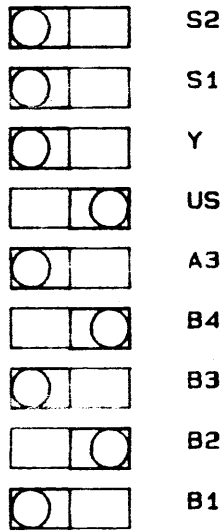
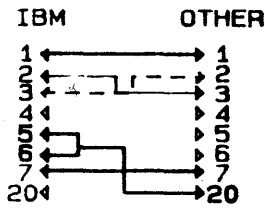

## SWITCH SETTINGS

---

 SWITCH SETTINGS FOR EPSON PRINTERS

ON	OFF	ON	OFF
1. X		1.	X
2. X		2.	X
3.	X	3.	X
4.	X	4.	X
		5.	X
		6. X	
		7. X	
		8. X	

## OKIDATA with PLUG AND PLAY

ON	OFF
1.	X
2.	X
3.	X
4.	X
5.	X
6.	X
7.	X
8.	X

