

GA27-3185-0  
File No. S370-09

**Systems**

**IBM Data Communication  
Device Summary**

**IBM**

GA27-3185-0  
File No. S370-09

**Systems**

**IBM Data Communication  
Device Summary**



## Preface

This publication provides basic information about current IBM data communication (teleprocessing) equipment (devices and systems) that can operate remotely over a communication line with an IBM processor.

Where it is important in this publication to point out that the arithmetic, logical, and control functions of a processor are directly affected during an operation, the term "CPU" is used instead of "processor" because a processor may physically contain a CPU and storage, and sometimes channels. For a discussion of the CPU, see the appropriate Principles of Operation publication.

This publication is divided into two sections:

- Section 1 describes data communication concepts and includes the type of attachment needed for remote data communication devices and systems (terminals).
- Section 2 describes the data communication devices and systems.

Appendix A is a glossary of terms and abbreviations that do not appear in the *IBM Data Processing Glossary*, GC20-1699.

Input/output devices and systems that can be remotely attached to a particular IBM processor are listed in the input/output configurator for that processor.

For further information about the devices and systems described in this manual, consult the *IBM System/370 Bibliography*, GC20-0001, for the order number of the appropriate reference manual.

### *First Edition (October 1978)*

Changes are periodically made to the information herein; before using this publication in connection with the operation of IBM systems (or equipment), consult the latest *IBM System/370 Bibliography*, GC20-0001, for the editions that are applicable and current.

Publications are not stocked at the address given below; requests for IBM publications should be made to your IBM representative or to the IBM branch office serving your locality.

A form for reader's comment is provided at the back of this publication. If the form has been removed, comments may be addressed to IBM Corporation, Publications Development Department E02, PO Box 12195, Research Triangle Park, NC, U.S.A. 27709. IBM may use or distribute any of the information you supply in any way it believes appropriate without incurring any obligation whatever. You may, of course, continue to use the information you supply.

## Contents

<b>Section 1. Introduction</b> . . . . .	1-1	<b>DATA TRANSMISSION MULTIPLEXERS</b> . . . . .	2-7
Elements of a Data Communication Network . . . . .	1-2	2701 Data Adapter Unit . . . . .	2-7
Host Processor . . . . .	1-2	3704 Communications Controller Models A1, A2, A3, and A4 . . . . .	2-8
Communication Control Devices . . . . .	1-2	3705 Communications Controller Models A1, A2, B1-B4, C1-C6, D1-D8, E1-E8, F1-F8, G1-G8, and H1-H8 . . . . .	2-9
Modulation/Demodulation Devices . . . . .	1-2	<b>MODULATOR/DEMULATOR UNITS</b> . . . . .	2-11
Communication Lines . . . . .	1-2	2711 Line Adapter Unit . . . . .	2-11
Line Disciplines . . . . .	1-4	3872 Modem . . . . .	
Terminals . . . . .	1-4	3874 Modem . . . . .	
Programming Systems . . . . .	1-5	3875 Modem . . . . .	2-11
Data Communication Applications . . . . .	1-6	<b>DISPLAY DEVICES</b> . . . . .	2-12
Systems Network Architecture (SNA) . . . . .	1-6	3275 Display Station Models 1, 2, 11, and 12 . . . . .	2-12
Advanced Function for Communication . . . . .	1-7	<b>SYSTEMS</b> . . . . .	2-13
Attachment of Data Communication Equipment . . . . .	1-7	1030 Data Collection System . . . . .	2-13
		1050 Data Communication System . . . . .	2-14
		3270 Information Display System . . . . .	2-15
<b>Section 2. Data Communication Equipment</b> . . . . .	2-1	3600 Finance Communication System . . . . .	2-17
<b>AUDIO COMMUNICATION DEVICES</b> . . . . .	2-1	3650 Retail Store System . . . . .	2-20
7770 Audio Response Unit Model 3 . . . . .	2-1	3660 Supermarket System . . . . .	2-23
<b>DATA TERMINAL DEVICES</b> . . . . .	2-2	3740 Data Entry System . . . . .	2-24
1001 Data Transmission Terminal . . . . .	2-2	3770 Data Communication System . . . . .	2-26
2740 Communications Terminal Models 1 and 2 . . . . .	2-2	3790 Communication System . . . . .	2-28
2741 Communications Terminal . . . . .	2-3		
3735 Programmable Buffered Terminal . . . . .	2-4	<b>Appendix A. Glossary and Abbreviations</b> . . . . .	A-1
3767 Communication Terminal . . . . .	2-5		
3780 Communications Terminal . . . . .		<b>Index</b> . . . . .	X-1
3781 Card Punch . . . . .	2-5		

## Section 1. Introduction

Data communications (teleprocessing) is the processing of data that is received from or sent to remote locations by way of communication facilities.

A data communication network consists of a number of communication lines (communication facilities) connecting a data processing system with remote data communication devices (Figure 1-1). Such devices can be terminals, control units, or other data processing systems. In this overview, any machine or group of machines capable of generating and/or receiving signals transmitted over communication lines will be referred to as a terminal or terminals. Thus, terminals may be data processing systems, communication systems such as the IBM 3270 Information Display System, or a single unit such as the IBM 2740 Communications Terminal.

As an example of how a data communication network functions, a clerk in an insurance company's branch office receives a telephone call asking for information about an insured's account. Asking the caller to hold the line, the clerk enters the information request into a terminal, and the request is sent over a communication line to the IBM processor at the insurance company's main office. When the request reaches the computer,

several things happen. The computer interrupts processing whatever job it is working on and saves all necessary data and instructions so that it can resume processing the job at the exact point of interruption. As the information is received over the communication lines, the communication module in the control program converts the data into machine language, stores it in a buffer area, and checks to see that it was transmitted correctly.

The nature of the request may dictate that a number of operations be performed. To process the request, the data communication program directs the IBM processor to examine the appropriate policy file and bring the insured's record from storage. The program then searches the record for the information requested and sends it over the communication lines to the clerk who originated the request. The clerk reads the information as it is displayed or typed out at his terminal and relays the information to the policy holder or adjuster waiting on the telephone.

At the main office, the control program has returned the processor to its status prior to the interruption, and the computer has resumed processing. As a result of the

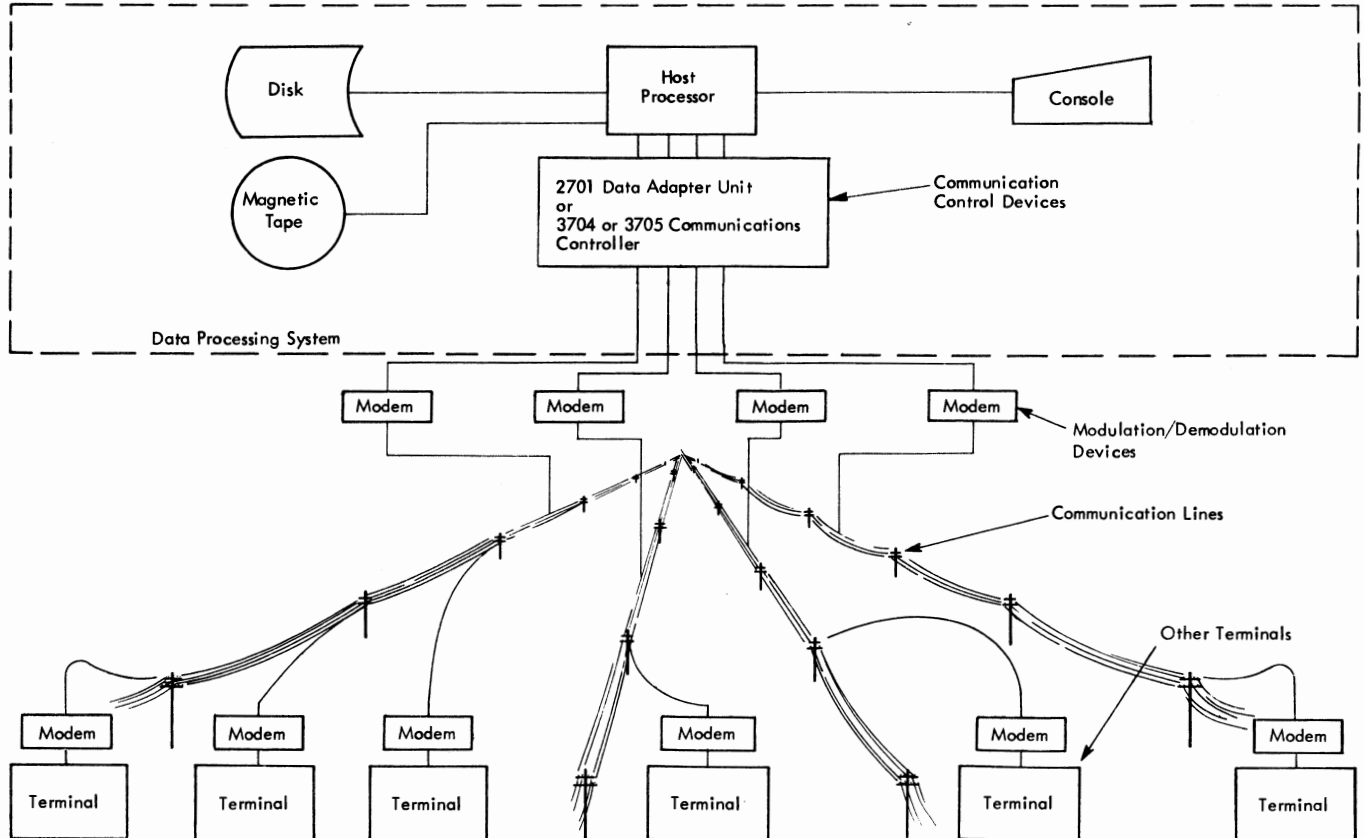

Figure 1-1. A Data Communication Network

telephone inquiry, the clerk in the branch office may update the insured's record and transmit this information to the IBM processor at the main office at a later time.

## ELEMENTS OF A DATA COMMUNICATION NETWORK

The elements of a data communication network (Figure 1-1) consist of a host processor, communication control devices, modulation/demodulation devices (modems), communication lines, other terminals, and programming systems. Three of these elements, the communication control devices, modems, and communication line, constitute a *data link* (Figure 1-2).

### Host Processor

IBM processors are able to serve as the host processor in a data communication network. Requirements for the host processor include multiprogramming capability, adequate storage capacity, storage protection, adequate speed for the applications required, and, for planning purposes, the potential for expanding storage capacity and speed.

The host processor for a data communication network must be able to handle random and unscheduled input, as well as serialized and scheduled input.

### Communication Control Devices

Communication control devices are hardware components that link the communication lines to the host processor. These devices can be external to the processor, such as the IBM 3704 or 3705 Communications Controller, or they can be a part of the processor, such as the integrated communications adapter feature. When control devices are external units, they can be classified as data transmission multiplexers.

The transfer of data requires noninformation transmissions for setting up, controlling, checking, and terminating information exchange. These noninformation exchanges constitute *data link control*. Communication control devices handle data link control; thus, functions of these devices include:

- Synchronization (getting the receiver in step with the transmitter)
- Identifying the sender and receiver
- Delimiting the beginning and ending of information (code translation)
- Error detection and recovery

In order for a host processor to send data over communication lines, the data must be converted

(serialized) to a serial stream of binary digits. Likewise, when the host processor receives data from a remote terminal, this data must be reconverted (deserialized) into machine language for processing (Figure 1-2). Control devices perform this function.

### Modulation/Demodulation Devices

After data which is to be transmitted is serialized by the control device, the binary signals must be converted to audio-frequency signals (modulated) for transmission over communication lines and reconverted (demodulated) at the other end. A modulation/demodulation device or modem performs this function. One modem is required at each end of a data link (Figure 1-2). Data sets and line adapters have the same functions as a modem.

Depending upon the type of communication lines and modem equipment, transmission of data can be voice grade (permits transmission of both data and human voice) or subvoice-grade (transmission of data only). A modem can be an integral part of a control device or terminal, or it can be an external unit.

### Communication Lines

Communication lines are classified according to:

- Configuration
- Transmission direction
- Type
- Transmission mode

#### Configuration

Two basic communication line configurations are:

- Point-to-point (connects two terminals).
- Multipoint (connects multiple terminals). In a multipoint configuration, one terminal must always be designated as the primary (control) terminal, and all others are secondary (tributary) terminals.

#### Transmission Direction

A communication line that transmits data in either direction, but not simultaneously, is called *half-duplex*. A line that transmits in both directions at the same time is called *duplex* or *full duplex* (Figure 1-3).

#### Type

Basically, two types of communication lines are available: *switched* and *nonswitched*.

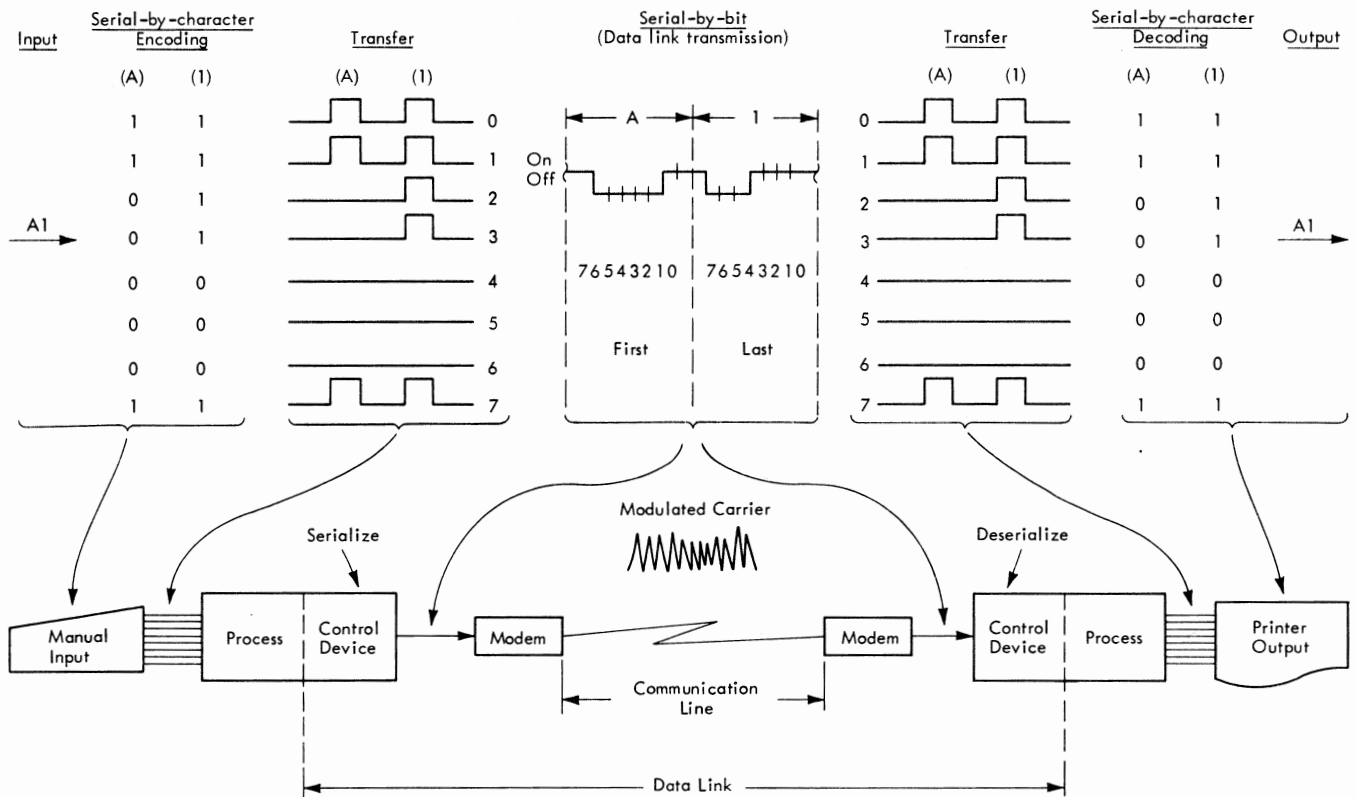

Figure 1-2. Data Conversion for Data Transmission

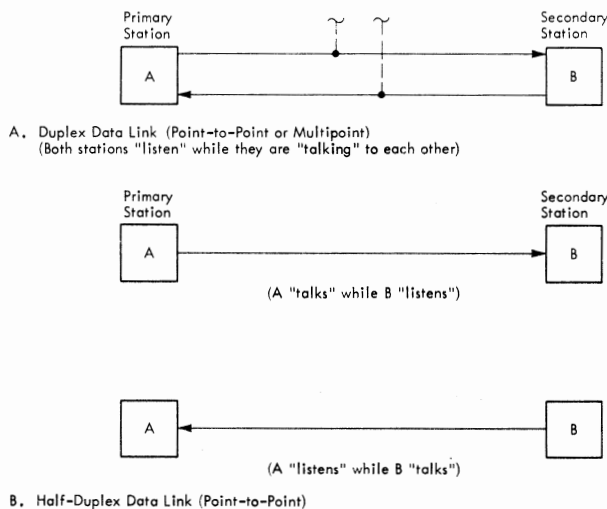

Figure 1-3. Communication Line Configurations

**Switched lines** (also called dial) connect terminals by means of common carrier exchange equipment. Dialing establishes a connection, which is maintained only while data is being transmitted. Switched lines are half-duplex only.

**Nonswitched lines** are available for use at any time, and dialing is not required to make a connection. Nonswitched lines may be either leased or private lines.

Leased lines are leased from a communication common carrier and are usually telephone or telegraph lines. Private lines are privately owned and may be supplied by the data communication network owner or by a communication equipment company.

Duplex transmission requires leased or private lines (nonswitched).

### Transmission Mode

Communication lines can transmit in asynchronous mode (also called serial start-stop mode) or synchronous mode.

Asynchronous transmission requires the use of start and stop bits to designate the beginning and ending of transmission.

Synchronous transmission is transmission in which the sending and receiving terminals are operating continuously at substantially the same frequency: the receiving terminal on a communication line operates in step with the transmitting terminal through the recognition of a specific bit pattern (sync pattern) at the beginning of each transmission. Synchronous mode, therefore, eliminates the need for start and stop bits and permits continuous uninterrupted transmission, increasing transmission speed and reducing turnaround time.

### Codes

A variety of codes can be used to represent data characters when transmitting over communication lines.

Two of the most commonly used are ASCII (American National Standard Code for Information Interchange) and EBCDIC (Extended Binary Coded Decimal Interchange Code). ASCII offers 128 possible characters. EBCDIC has 256 possible code combinations, of which 17 are used for control purposes, 96 are used for text characters, and the remaining are unassigned.

### Line Disciplines

A line discipline provides a set of rules for the orderly transfer of data from one location to another using communication facilities. Two line disciplines currently used are binary synchronous communications (BSC) and synchronous data link control (SDLC).

### Binary Synchronous Communication

Binary synchronous communication (BSC) procedure provides for synchronous transmission of binary-coded data. BSC expands transmission capability in a data communication network through its ability to accommodate three different transmission codes and a broad range of medium- and high-speed equipment. BSC offers intermix capabilities which allow different types of BSC terminals to communicate with the host processor (functioning as the control terminal) on a nonswitched multipoint network, or with the host processor (functioning as the central terminal) over a switched point-to-point network. Also available with BSC is a transparency feature which permits greater versatility in the range of coded data that can be transmitted. This versatility is achieved because all data, including the normally restricted data link line control characters, is treated as specific "bit patterns" (data only) when transmitted in transparent mode. Thus, unrestricted coding of data is permitted for transparent mode operation. This is particularly useful for transmitting binary data, floating-point numbers, packed decimal data, and so on.

### Synchronous Data Link Control

Synchronous data link control (SDLC), a more sophisticated line discipline than BSC, provides for the efficient management of synchronous data transmission between buffered terminals using centralized control over communication lines.

SDLC can transmit over duplex or half-duplex, switched or nonswitched lines. Whereas SDLC configurations may be point-to-point, multipoint, or multi-multipoint (Figure 1-4), BSC uses point-to-point or multipoint configurations. Also, SDLC will accommodate *any* code while BSC accommodates three codes.

SDLC offers a fixed format for transmission which eliminates many of the control characters required for BSC transmission. When using SDLC:

- Message delimiting is not required.
- Error checking is automatic.

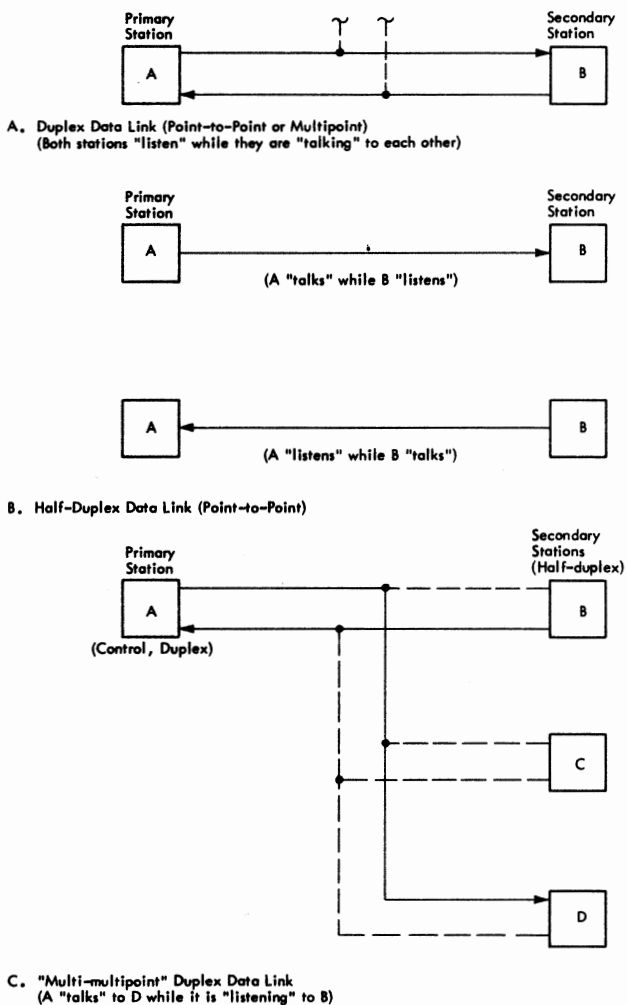

Figure 1-4. Data Link Configuration

- Previous transmissions can be confirmed at the same time that additional data is being transmitted.
- Any type of data, coded or noncoded, can be transmitted.

SDLC allows terminals with different characteristics to share a single communication line. Thus hard-copy (printer) terminals and video-display terminals can share the same communication lines.

### Terminals

The type of terminal used for handling data flow in a data communication network depends upon the complexity and capability (applications) required for a specific network. The terminals are the workhorses of the network. All useful data is received from or sent to the terminal.

Terminals can be keyboard displays, keyboard printers, a communication system such as the IBM 3270 Information Display System, or a System/370. Terminals can prerecord data on diskettes or tape for batch transmission or mailing. Terminals can accommodate asynchronous (start-stop) and synchronous (BSC and



SDLC) modes of transmission. Many combinations of these features and other features are possible.

### Programming Systems

A programming system is a developed, tested, and documented group of support programs which include:

- Controlling and scheduling of I/O devices
- Job, task, and data management
- Application programs
- Utilities

Included in data management is data communication device support which provides a link between the application program and remotely connected data communication terminals via the communication control device. This support is divided into three access methods which aid the host processor application programs in obtaining data from remote terminals.

*Basic or Virtual Telecommunications Access Method (BTAM/VTAM)* directs the transmission of data between the host processor application programs and terminals. BTAM/VTAM provides basic capabilities to:

- Receive messages
- Send messages
- Chain input buffers
- Dial and answer (switched lines)
- Detect and correct errors
- Perform code translation

Stated simply, BTAM/VTAM controls terminal input/output operations.

If queued control is required in an asynchronous transmission mode network, *Queued Telecommunications Access Method (QTAM)* is available. QTAM includes BTAM capabilities as well as message queuing, routing, and logging.

If queued control is required in a synchronous transmission mode network, *Queued Telecommunications Access Method (TCAM)* is available. For example, data can be directed to an inactive terminal and held in the queue until that terminal is activated and connected.

SDLC line discipline utilizes VTAM which connects, disconnects, and controls access between the application programs and all the terminals in the network whether they are locally or remotely attached. Although a terminal may be allocated at one time to a specific application, the communication control devices and communication lines are shared among concurrently active application programs. Different terminals, multidropped on one line, may concurrently communicate with different application programs. When an IBM 3704 or 3705 Communications Controller is installed as the control device, VTAM allocates some of the network management responsibilities to this unit.

The *Network Control Program/Virtual Storage (NCP/VS)* operates with the IBM 3704 or 3705 to route data through the network. Through commands sent from VTAM, the NCP/VS assumes much of the responsibility for controlling communication lines (Figure 1-5). Thus, valuable host processor space is freed for higher, application-related functions. Also, because some control is exercised locally (in the 3704 and 3705), line traffic is reduced and line costs are lowered.

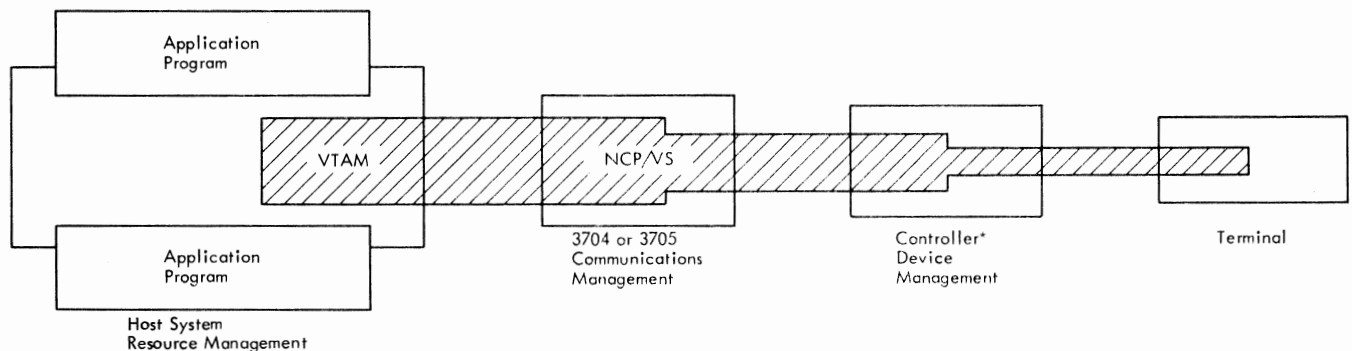

\* 3601, 3651, and 3791 are examples

Figure 1-5. Concept of Function Distribution under Programming Control

## DATA COMMUNICATION APPLICATIONS

The types of applications which are provided by a data communication network are many and varied. Some of the most widely used applications include:

- *Data Entry.* Entry of data from a remote terminal into a host processor via a communication link by a remote terminal.
- *Record Update.* Alteration, deletion, or addition of data contained on existing data files stored at the host processor site via a communication link from a remote terminal.
- *Remote Job Entry.* Entry of logic functions from a remote terminal to be executed at the host processor location via a communication link.
- *Message Switching.* The ability to relay a message from one remote terminal to one or more remote terminals via a host processor and a series of communication links.
- *Time Sharing.* The allocation of host processor resources so that many remote terminals may execute programs concurrently and may interact with the programs during execution.
- *Data Acquisition and Process Control.* A high-speed data acquisition system is designed to maintain constant communication with a process for such purposes as:
  1. Determining whether the process is operating within acceptable limits.
  2. Providing records for accounting or management decisions.
  3. Providing a record of data obtained during a research experiment.

A process control system usually incorporates data acquisition facilities and has the additional capability of using the acquired data as a basis for supervising and controlling the process.

## SYSTEMS NETWORK ARCHITECTURE (SNA)

Systems Network Architecture reorganizes the best of what is already known about data communication networks and produces greater equipment utilization and economy in operation. By combining a single access method, a single network control program, and a single communication line control, SNA offers an orderly approach to supplying current communication needs and a sound foundation for advanced applications (future needs). See Figure 1-6.

SNA introduces standardization into communication systems:

- A single, standardized line discipline—SDLC
- A single, standardized access method—VTAM
- A network control program—NCP/VS
- A family of standardized, mutually compatible terminals:
  - IBM 3270 Information Display System (Models 11 and 12)
  - IBM 3600 Finance Communication System
  - IBM 3650 Retail Store System
  - IBM 3660 Supermarket System
  - IBM 3767 Communication Terminal
  - IBM 3770 Data Communication System
  - IBM 3790 Communication System

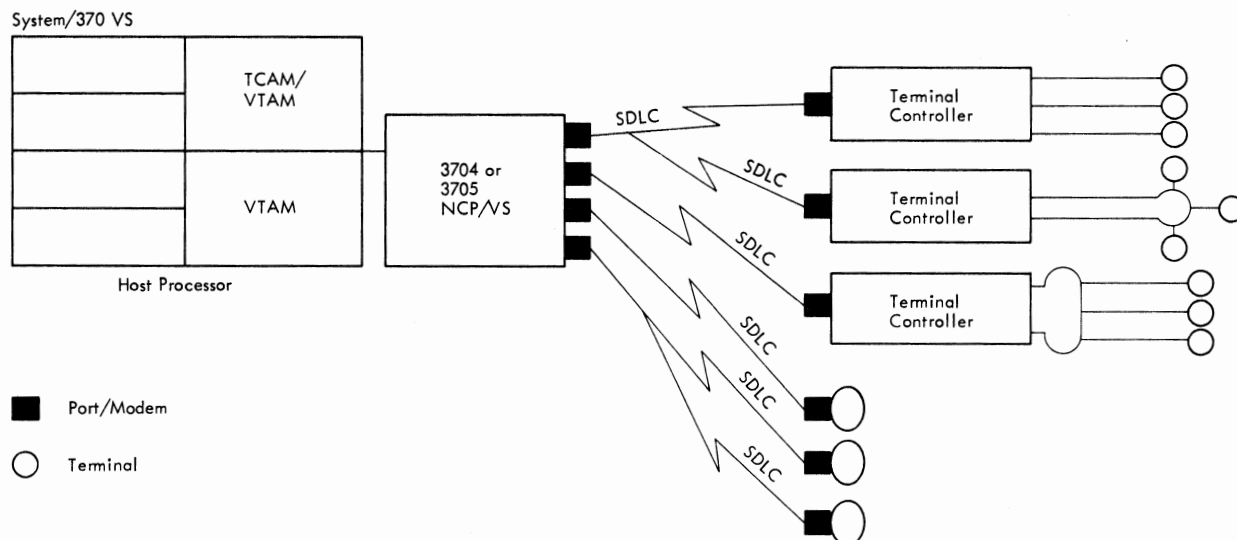

Figure 1-6. Systems Network Architecture

## ADVANCED FUNCTION FOR COMMUNICATION

An extension of SNA, advanced function for communication ties this mutually compatible family of terminals and virtual system operations into a unified communication structure. This structure, through partitioned emulation programming (PEP), allows the IBM 3704 and 3705 Communications Controllers to operate as an IBM 2701 Data Adapter Unit, thus permitting attachment of terminals that use BSC or start-stop line control within the same network (Figure 1-7).

## ATTACHMENT OF DATA COMMUNICATION EQUIPMENT

IBM equipment that can be attached to a communication line for remote operation with an IBM processor includes:

1. I/O devices and systems (terminals), which, with their associated controls (may be integrated or a separate device), can communicate with IBM processors over communication lines that have a modem at each end of the line.
2. Data transmission multiplexers, which include the IBM 2701 Data Adapter Unit, the IBM 3704 Communications Controller, and the IBM 3705 Communications Controller. These devices can be

attached to an IBM channel to control communications between the system and the remote I/O equipment.

3. The integrated communications adapter (ICA) on an IBM processor, which permits direct attachment of one or more communication lines and provides communication control between the system and one or more remote terminals.
4. Modulator/demodulator devices, which include the IBM 2711 Line Adapter Unit, the IBM 3872 Modem, the IBM 3874 Modem, and the IBM 3875 Modem. These devices perform signal conversion between a communication line and the sending or receiving equipment. The 2711 can be attached to some IBM processors that have either the ICA installed or to the 3704 or 3705 Communications Controllers. The 3872, 3874, or 3875 can be attached to sending or receiving equipment at each end of a communication line.
5. The IBM 7770 Audio Response Unit, which provides an audio response to a signal from a remote inquiry terminal. The 7770 can be attached to an IBM channel.

Figure 1-8 shows which IBM I/O devices and systems (terminals) can be attached to IBM processors for remote online operation over communication lines. For further information about these attachments, see the IBM Input/Output Configurator, for the processor.

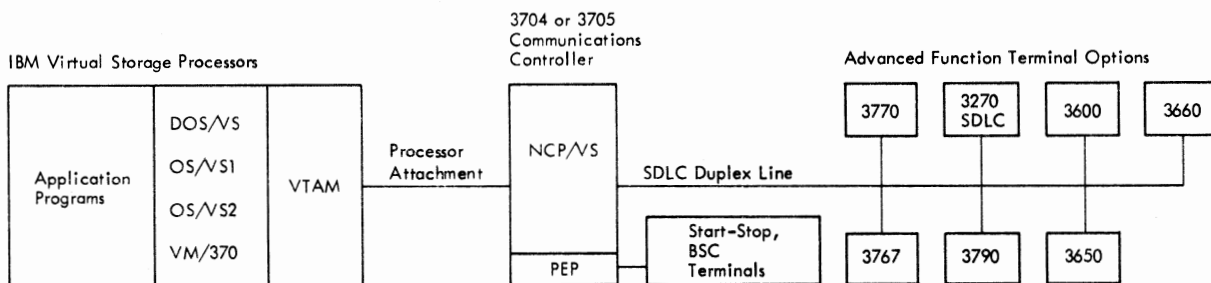

Figure 1-7. Advanced Function for Communication

I/O Device, Control, or System (Terminal)	Model	Attachment to Line*
<b>Audio Communication Devices</b>		
7770 Audio Response Unit*	3	Direct
<b>Data Terminal Devices</b>		
1001 Data Transmission Terminal	1	Direct
2740 Communications Terminal	1, 2	
2741 Communications Terminal	1	
3735 Programmable Buffered Terminal	1	
3767 Communication Terminal	1-3	
3771 Communication Terminal	All	
3773 Communication Terminal	All	
3774 Communication Terminal	All	
3775 Communication Terminal	All	
3776 Communication Terminal	All	
3777 Communication Terminal	All	
3780 Data Communications Terminal	1	
<b>Data Transmission Multiplexers</b>		
2701 Data Adapter Unit**	1	Direct
3704 Communications Controller**	A1-A4	
3705 Communications Controller**	All Models	
<b>Display Devices</b>		
3275 Display Station	1, 2, 11, 12	Direct
<b>Systems</b>		
1030 Data Collection System	—	1031**
1050 Data Communication System	—	1051**
3270 Information Display System**	—	3271-1, -2, -11, -12**
3600 Finance Communication System**	—	3601/3602**
3650 Retail Store System**	—	3651-A50, -B50**
3660 Supermarket Scanning System**	—	3651-A60, -B60**
3660 Supermarket Key-Entry System**	—	3661**
3740 Data Entry System	—	3741-2, -4, 3747**
3770 Data Communication System**	—	Direct
3790 Communication System**	—	3791**

**Legend:**

- \* Includes modulation/demodulation equipment at each end of the line (may be part of the sending or receiving device).
- \*\* Part of the remote system.
- Not applicable.

Figure 1-8. Attachment Data for Data Communication Equipment

## Section 2. Data Communication Equipment

### Audio Communication Devices

#### 7770 Audio Response Unit Model 3

The IBM 7770 Audio Response Unit Model 3 (Figure 2-1) provides a composed audio response to digital inquiries from a 1001 Data Transmission Terminal, a telephone set, or other inquiry-type terminals. The spoken response is composed from an American English vocabulary prerecorded in voice form on a magnetic drum within the 7770. The response is transmitted over appropriate common-carrier communication facilities back to the inquiring terminal. When the 7770 is operating in conversational mode, the inquiry-response sequence may be repeated any number of times without redialing the 7770.

To make an inquiry of the 7770, the calling party enters a series of characters from his terminal. The 7770 passes these characters one by one via the byte multiplexer channel to the CPU which processes the inquiry and sends a response message back, character by character, to the 7770. This response message is a series of drum word addresses that the 7770 uses to select the proper words for its spoken reply. There is no limitation on the length of the inquiry or of the response.

The 7770 Audio Response Unit Model 3 attaches to the CPU via the byte multiplexer channel. Each 7770 occupies one control-unit position and requires one byte multiplexer subchannel for each communication line. The basic 7770 handles four half-duplex, voice-grade communication lines, but this capacity can be expanded in four-line increments to 48 lines. Random inquiries on all input/output lines can be responded to simultaneously. All data sets must be provided by a common carrier.

Each 7770 comes with a 32-word vocabulary that can be expanded in 16-word increments to a maximum of 128 words. Vocabulary words may be specified by the user according to message requirements. However, lengthy words must be split and will count as two words. The vocabulary can be changed at any time by removing the drum and replacing it with another having a different vocabulary. One word of each user vocabulary must be silence.

#### *Special Features*

***I/O Line Expander:*** Each I/O line expander feature provides for four additional input/output lines. A maximum of 11 of these features is allowed.

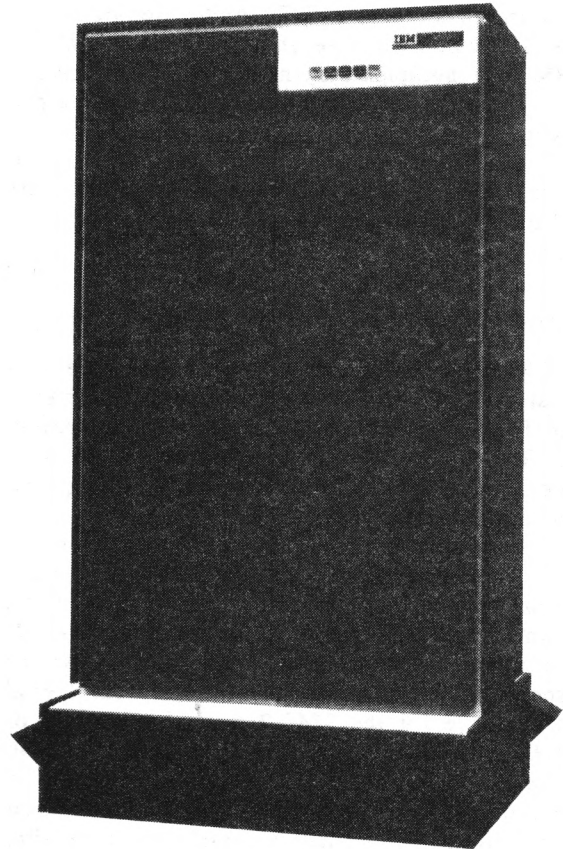

Figure 2-1. IBM 7770 Audio Response Unit

***I/O Line Frame:*** This feature provides an additional frame when the number of input/output lines exceeds 16.

***I/O Line Panel:*** An I/O line panel is required for each group of eight input/output lines or portion thereof added beyond the first eight lines. A maximum of five panels is allowed.

***Additional Vocabulary Words:*** Increments of 16 words may be added up to the maximum of 128 words.

***End of Inquiry (EOI) Disable:*** Allows EOI character on pushbutton telephones to be used as a data character instead of an EOI character.

## Data Terminal Devices

### 1001 Data Transmission Terminal

The IBM 1001 Data Transmission Terminal (Figure 2-2) is a combination punched card and keyboard unit used for direct transmission to a 7770 Audio Response Unit Model 3. The audio response unit is, in turn, connected to an IBM byte multiplexer channel. The 1001 transmits at 12 characters per second over common-carrier nonswitched communication lines, common-carrier switched telephone networks, or privately owned voicegrade facilities. The connection between the 1001 and the audio response unit is established by dialing a telephone.

### 2740 Communications Terminal Models 1 and 2

The IBM 2740 Communications Terminal (Figure 2-3) features an IBM SELECTRIC® typewriter appropriately modified for use as a general-purpose communication terminal. Thus, the 2740 can function alternately as a typewriter (local mode) or as a data sending and receiving unit (communicate mode).

Data is transmitted in half-duplex mode over the attached communication lines. The maximum transmission rate is 14.8 characters per second for the 2740-1 and 60 characters per second for the 2740-2. Effective transmission rates may be less, because varying typing speeds affect the 2740-1 operating speed. Special features available for the 2740-2 may also increase or decrease the transmission rate. In either mode, the 2740 can be operated by any typist with a minimum of additional training. System control keys and indicator lights are conveniently located alongside the typewriter keyboard.

The 2740 is available in two models. The 2740-1 can communicate with other 2740-1 terminals directly or



Figure 2-3. IBM 2740 Communications Terminal Model 1

with an IBM processor; the 2740-2 is designed exclusively for communicating with the processor.

The types of operation that can be specified for the 2740-1 are:

1. Between two terminals over either leased common-carrier private lines or common-carrier switched networks.
2. Between a terminal and an IBM processor over the above-mentioned facilities.

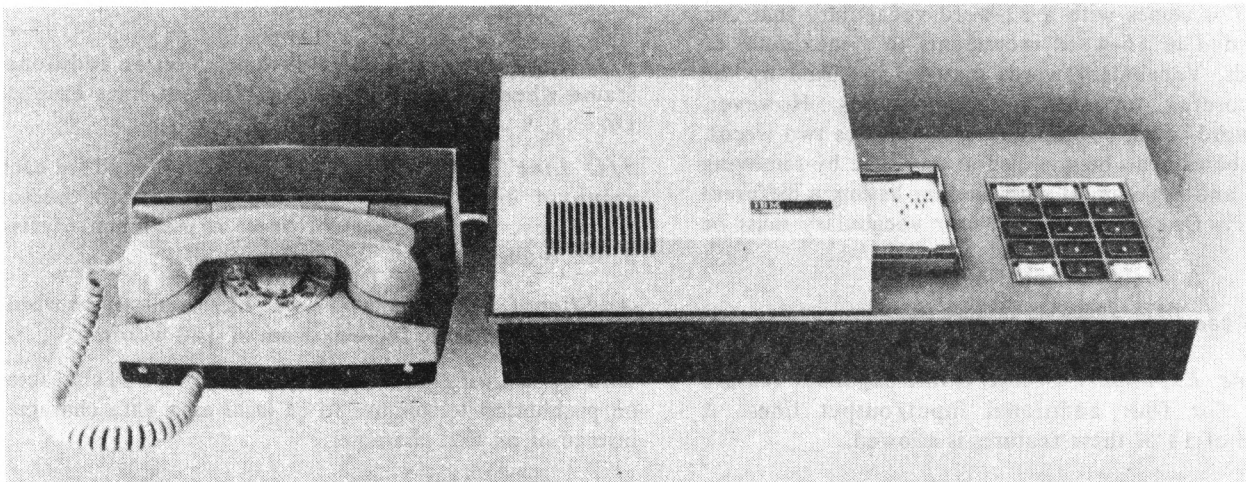

Figure 2-2. IBM 1001 Data Transmission Terminal

3. Between a terminal and two or more other terminals over leased common-carrier private lines.
4. Between an IBM processor and two or more terminals over leased common-carrier private lines.

When the 2740-1 is operating in communicate mode, each message character keyed at the sending terminal is printed at both the sending and receiving terminals. The 2740-2 is designed to enable the key input from the typewriter keyboard to be printed at the sending terminal, stored in a buffer, and subsequently transmitted to an IBM processor.

The buffer storage on the 2740-2 provides improved operation through:

Faster transmission to and from the processor storage buffer  
 Visual verification before transmission  
 Easier correction of keying errors

Some of the many applications for which the 2740-1 is designed are:

*Intracompany Communications:* Internal communications between company departments can be easily handled with the 2740-1.

*Intercompany Correspondence:* To aid in sales and to expedite customer orders, a 2740-1 can be installed in the purchasing department of major customers.

*Executive Correspondence:* Effective two-way communications can be easily maintained between the executive offices and the sales or manufacturing locations by using the 2740-1.

*Remote Inquiry and Reply:* Using the 2740-1, persons having access to an IBM processor can handle inquiry and reply operations without leaving their department areas.

The buffer storage on the 2740-2 makes it particularly well-suited for remote inquiry and reply operations. Among the specific uses for this model are: payment entry, journal entry, administrative messages, file updating, and record renewal.

### 2741 Communications Terminal

The IBM 2741 Communications Terminals (Figure 2-4) is a modified IBM SELECTRIC® typewriter with electronic controls that enable it to operate as a remote conversational terminal, thus permitting direct access to an IBM processor. The 2741, when it is not being used for communications, may be used for normal office



Figure 2-4. IBM 2741 Communications Terminal

typing. Intended primarily for text-handling and scientific applications, the 2741 Communications Terminal permits persons at remote points to utilize the problem-solving capability of the IBM processor on a time-sharing basis. Some of the uses of the terminal are:

Online scientific computation  
 Online computer programming  
 Text handling (especially technical writing, proposal writing, and editing)

The 2741, considered by itself, is a typewriter capable of encoding the characters typed and presenting the signal to a communication channel. Therefore, the applications of this terminal are mostly determined by the program used by the computer system with which it is associated.

One processor can service many 2741's. The maximum number of terminals that can be used in one configuration depends on either the communication facilities selected or the capacity and equipment of the computer system.

### 3735 Programmable Buffered Terminal

The IBM 3735 Programmable Buffered Terminal consists of a specially designed keyboard coupled with an IBM SELECTRIC® II Printer (Figure 2-5). Under program control, the 3735 stores information generated during source-document preparation for later transmission to an IBM processor. Typically, the Selectric keyboard printer prepares preprinted (fixed-format) forms and stores a full day's operator output for unattended transmission to the processor, and the processor can return data for use in the next day's operation.

In a typical installation, the 3735 can be used in an office for order entry, billing, inventory control, claims (related policies), or any accounting operations. During daily document preparation, the 3735 provides operator guidance (setup instructions, exception messages, indication of keying or procedural errors): programmed forms control (automatically positioning data within the predefined fields); format and edit operations (center, left/right justify, underline, character fill, decimal-comma insertion); logical decisions (conditional field skipping and entry); arithmetic operations (add, subtract, multiply, and divide); and power typing (automatic printing of information previously entered or internally generated).

A disk storage device within the control unit contains the terminal control program, form description programs, and user data storage. Basic storage capacity is about 62,800 bytes. The storage capacity is expandable in three increments to a maximum capacity of approximately 314,100 bytes.

The 3735 uses the binary synchronous method of communication line control; thus it is compatible with most systems and programs using this method of line control. Transmission may be 1200, 2000, 2400, or 4800 bps.

Standard features include:

*Switched Network Operation*, which permits communication transfer through telephone lines normally used for dialed telephone calls.

*Auto Answer*, which permits transmission and reception of messages on an unattended basis.

Optional features include:

*Synchronous Clock*, for use with data sets that do not have an internal clock.

*Keylock*, a key-operated security switch on the control unit, which limits I/O operation of the keyboard/printer.

*Forms Stacker*, which permits placement of continuous forms (out of carton) on the stand above floor level, and provides for forms stacking after printing.

*Multipoint Data Link Control*, which allows multiple 3735's to be used on the same communication line with a CPU.

*5496 Attachment*, which permits a 3735 to be attached to an IBM 5496 Data Recorder.



Figure 2-5. IBM 3735 Programmable Buffered Terminal



### 3767 Communication Terminal

The IBM 3767 Communication Terminal (Figure 2-6) is a compact, movable, desk-top terminal that furnishes access to a remote IBM processor via SNA (systems network architecture). To provide a migration path from start-stop to synchronous data link control (SDLC), the 3767 offers special start-stop features for 2741, 2740 Model 1, or 2740 Model 2 support. If a start-stop feature is installed, a switch allows selection between start-stop and SDLC line control, for connection to a corresponding start-stop or SDLC multiplexer port.

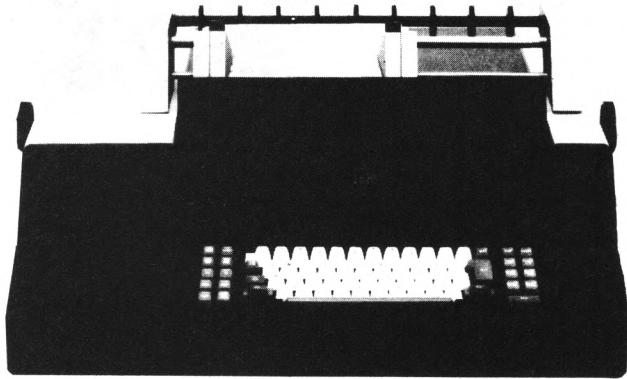

Figure 2-6. IBM 3767 Communication Terminal (Design Model)

Some of the online uses of the 3767 are:

- Computer programming
- Data entry
- Data base inquiry and update

When it is not communicating with an IBM processor, the 3767 may be used for normal secretarial typing.

The IBM 3767 is available in three models, with standard characteristics as follows:

Model	Printing Rate (Characters per second)	Buffer Size
3767-1	40 cps average	512 bytes optional
3767-2	80 cps maximum	512 bytes basic
3767-3	120 cps maximum	512 bytes basic

Buffer expansion special features for up to 1,024 bytes are available for all three models.

Safeguards against unauthorized use of the terminal are provided by:

**Security keylock** (optional, which provides a key-operated switch.

**Magnetic stripe reader** (optional), which reads information from magnetically striped and encoded ID card.

**Print suppress** (standard), which allows selected data fields to be entered without being printed.

Other features include:

**Bidirectional printing** (standard), which increases throughput by reducing the number of carriage returns.

**Alternate character set** (optional), which provides a switch control for printed graphics alternate to those selected by keyboard specification.

**Calculate-scientific** (optional), which, in offline mode under switch control and using the same keyboard, allows the following calculations to take place:

Addition	Exponential
Subtraction	Common logarithm
Multiplication	Natural logarithm
Division	Exponential constant
Inverse calculation	Circular constant
Square root	Trigonometrical functions
Statistical values	

Two memories are provided for temporary storage of totals.

### 3780 Data Communications Terminal

#### 3781 Card Punch

The IBM 3780 Data Communications Terminal (Figure 2-7) enables batched card data or source programming data to be transmitted at line speeds with printed output for remote data transmission applications. The 3780 consists of a printer, a card reader, and two 512-character buffers with buffer checking. The buffers act as an interface between the communication line and the 3780 card reader and printer.

The 3780 is especially suited for industry, government, and private users such as:

- Educational institutions and systems
- Federal government supply depots
- State and local government functions requiring centralized control
- Hospital or shared-hospital accounting systems

The 3780 uses the binary synchronous method of communication line control; thus it is compatible with most systems and programs using this method of line control. Transmission may be 1200, 2000, 2400, 4800, or 7200/3600 bps.

**Binary synchronous communication (BSC)**, with basic data link control, provides transmission checking and a choice of transmission codes. The choice depends on the application. However, for system compatibility, the same code must be chosen for all terminals on a particular communication line. The two available codes are the EBCDIC 256-character set and the ASCII 128-character set.

The 3780 operates in half-duplex mode via appropriate IBM modems over common-carrier or equivalent privately owned facilities. Private line channels may be half-duplex or duplex (required for speeds greater than 2400 bps), point-to-point or multipoint.

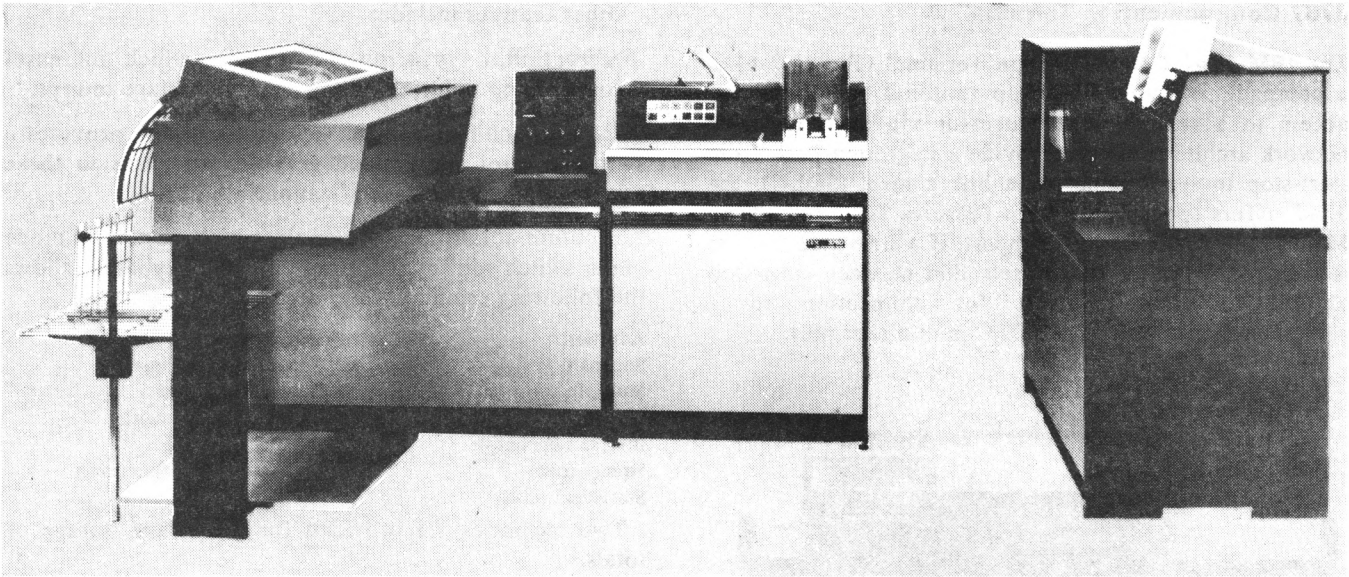

Figure 2-7. IBM 3780 Data Communications Terminal with IBM 3781 Card Punch

The 3780 prints 300 to 425 lines per minute with the printer providing 120 print positions, expandable to 144 positions. The actual print speed depends on the communication facilities used and the number of characters in the character set.

Characters	Print Rate
39-character set	425 lines per minute
52-character set	350 lines per minute
63-character set	300 lines per minute

The card reader reads punched cards at rates as high as 600 cards per minute. The actual throughput speed of the card reader depends on the number of card columns that are read.

Standard features include:

- *Home mode*, which allows data read by the card reader to be printed but not transmitted over the communication line. When the terminal is operating in home mode, the binary synchronous communication (BSC) adapter monitors the line to determine if a remote terminal or processor desires to transmit to or receive from the 3780.
- *Conversation mode*, which improves line efficiency in applications where an immediate processor message to the 3780 is required in response to a message from the 3780 terminal.

Optional features include:

- The *integrated 2400/1200 bps modem*, which allows data to be transmitted at 2400 bps with 1200 bps backup over both public and private communication facilities.

- *EBCDIC transparency*, which allows the 3780 to receive and transmit all 256 EBCDIC bit combinations as data characters.
- *Multipoint data link control*, which enables multiple 3780's to be used on the same communication line with the processor.
- The *print position* feature, which permits the printed output of the 3780 to use 144 print positions rather than 120.
- *Component selection*, which gives the 3780 the capability of attaching the 3781 Card Punch. This feature, which is compatible with other 3780 features and functions, provides the ability to select (1) I/O devices, (2) a multipoint data link control component, and (3) output data in accordance with predetermined priority.

### 3781 Card Punch

The 3781 Card Punch, which is attachable to the 3780, has a maximum punched card output of 160 columns per second, a 1,200-card hopper, a 1,300-card primary stacker, and a secondary stacker for error cards.

The output rate of the 3781, when all 80 columns are punched, is approximately 91 cards per minute. Throughput depends on the number of columns punched, the 3780 features used, and the communication facility used.

An *echo impulse check*, which causes incorrectly punched cards to be fed into a secondary stacker, is also provided. This feature allows the 3781 to make three attempts to punch a card correctly before terminating transmission.

## Data Transmission Multiplexers

Just as local cable-connected input/output devices require a control unit to interface their attachment to the system channels, devices that transmit over communication lines also require a control unit to perform interface matching, character assembly, and transmission control. In IBM data communication configurations, these functions may be performed by the IBM 2701 Data Adapter Unit and the IBM 3704 and 3705 Communications Controllers.

### 2701 Data Adapter Unit

The IBM 2701 Data Adapter Unit (Figure 2-8) provides for the online connection to an IBM processor of a variety of local and remote systems and devices. The connection can occur over private or common-carrier communication facilities (Figure 2-9).

Eight 2701's can be attached to an IBM channel, each occupying one control unit position. With the second channel interface special feature, the 2701 can be attached to any other channel on the same processor or to a channel on another processor. This means that different terminal devices on the 2701 can operate via separate channels. However, the assignment of terminals to channels is permanent; once a terminal is assigned to a particular channel, it can operate only via that channel.

Each 2701 provides for the attachment of up to four half-duplex (two ways, alternately) asynchronous communication lines with line speeds up to 600 bits per second, or up to four (maximum of two operating simultaneously) half-duplex synchronous communication lines with line speeds up to 230,400 bits per second, or up to four parallel data acquisition devices (word width

of 16 to 48 bits). Various combinations of the data communication and data acquisition devices are possible within any given 2701.

All necessary bit-byte and word-byte conversions, interface matching, and data control for attaching specific terminal devices are accomplished by the functional sections of the 2701. Many optional features are available for further refinement in meeting user requirements.

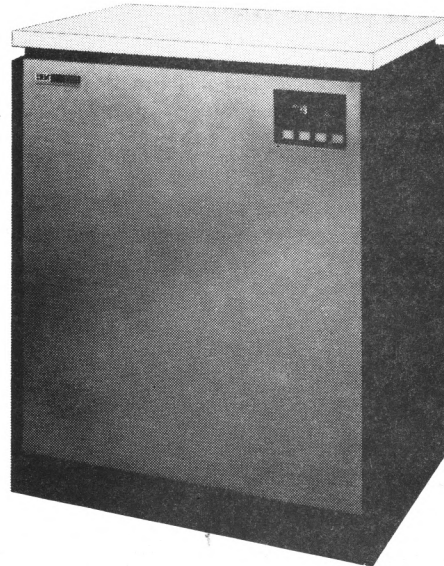

Figure 2-8. IBM 2701 Data Adapter Unit

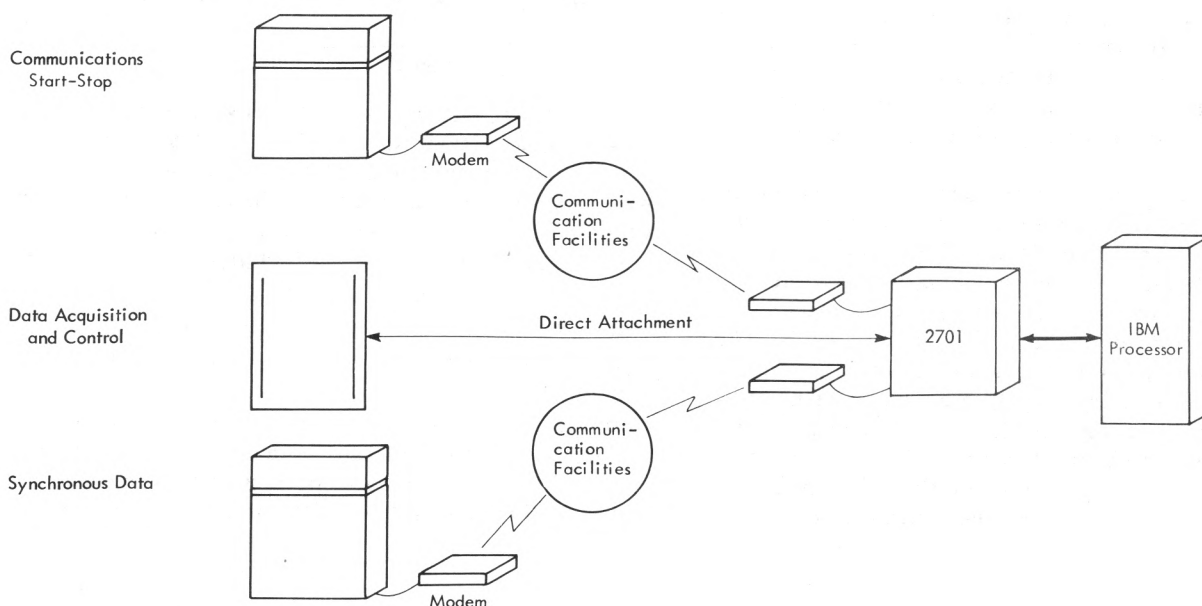

Figure 2-9. An IBM 2701 in a System Environment

### Optional Features

Optional features available for the 2701 include:

*Autocall*, which provides automatic dialing capabilities on appropriate communication facilities.

*Second Channel Interface*, which provides for the attachment of a second channel to the 2701.

*Dual Code*, available only with binary synchronous communication (BSC) attachment features, which allows either of two codes to be program-selected.

*Station Selection*, which allows the 2701 with a BSC attachment feature to operate as a tributary station on a leased communication line.

*Transparency*, which provides the capability for a BSC attachment to transmit and receive 8-bit binary data as well as EBCDIC or ASCII codes, or 6-bit binary data as well as Six-Bit Transcode.

### 3704 Communications Controller Models A1, A2, A3, and A4

The IBM 3704 Communications Controller (Figure 2-10) is a modular programmable control unit that provides expanded data communication capabilities. Designed to be an evolutionary replacement for the IBM 2701 Data Adapter Unit, the 3704 can attach as many as 32 communication lines.

The 3704 consists of a single module that contains a control function, a control panel, a channel adapter for attachment to an IBM processor, a communication scanner, and required line attachment hardware for communication lines. This hardware permits the 3704 to communicate with a variety of data communication devices.

This communications controller operates over common-carrier or equivalent customer-owned communication facilities at 45.5 bps to 50,000 bps. It is available in four models, representing various combinations of line and channel attachment hardware with storage capacities of 16K bytes to 64K bytes in 16K-byte increments. The 3704, with appropriate programming and the remote support feature, is able to operate as a remote network concentrator, collecting data from low-speed terminals and sending it at high speed to an IBM processor. Thus, the 3704 provides a high degree of flexibility in matching the requirements of a data communication network.

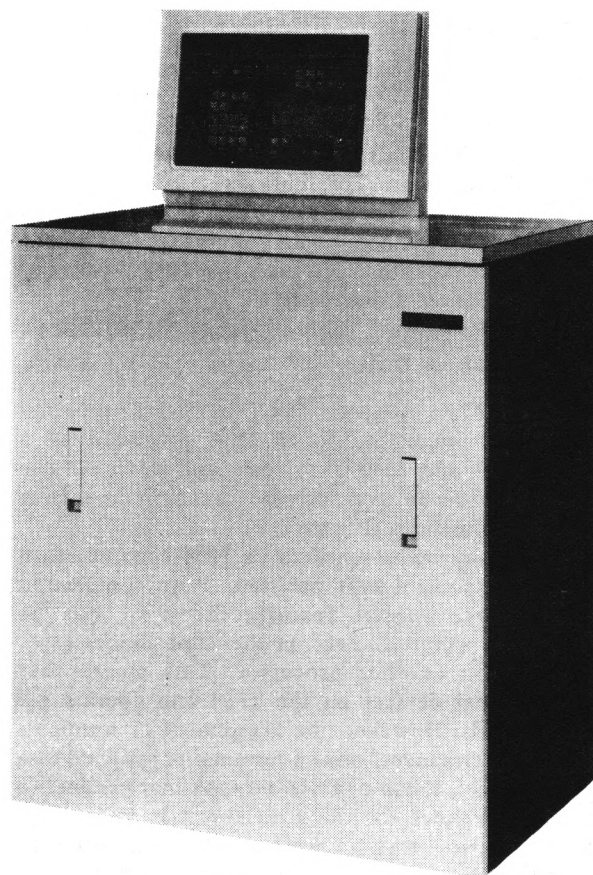

Figure 2-10. IBM 3704 Communications Controller

Prior to the 3704, many data communication functions now being executed in the 3704 were performed by access methods in a host processor. When these functions are executed in the 3704, the processor is freed to do more message processing and batch processing work.

#### Programming Support

Programming support for the 3704 includes a basic version and virtual storage (VS) version of both the network control program and the emulation program, as well as system support programs. When executing either version of the network control program, the 3704 requires only a single subchannel address, regardless of the number of communication lines attached. This represents a significant advantage over the 2701 Data Adapter Unit, which requires a separate subchannel address for each line.

*Network Control Program:* The basic and VS versions of the network control program, both of which are executed in the 3704, assume a major portion of line management and buffering responsibility. Characters are decoded and

assembled into messages before being released to the processor, thus conserving processor resources. Both basic and VS versions can support controls, terminals, and lines (up to 32) attached to a 3704, and perform such functions as:

- Communication line control
- Character checking
- Block checking
- Character buffering
- Polling
- Error-recovery procedures

Both versions also perform multiplexer functions such as converting outgoing message characters to serial bit stream (vice versa for incoming characters), recognizing control characters within message text, and checking for transmission errors.

The *Partitioned Emulation Programming Extension*, a feature of the network control program/VS, allows the program to operate some lines in network control mode while operating other lines in emulation mode.

**Emulation Program:** The basic and VS versions of the emulation program, both of which are executed in the 3704, allow the 3704 to operate with most programs written for the 2701 without modification. In addition, both versions provide an easy conversion path from the 2701 to the 3704. With either version, the 3704 can attach as many as 32 lines.

**System Support Programs:** These programs, which are executed in a processor, generate control programs, load them into controller storage, and also dump controller storage.

### **3705 Communications Controller Models A1, A2, B1-B4, C1-C6, D1-D8, E1-E8, F1-F8, G1-G8, and H1-H8**

The IBM 3705 Communications Controller (Figure 2-11) is a modular programmable control unit that can attach as many as 352 communication lines and requires only one channel interface to an IBM processor. It operates in asynchronous mode at 45.5 bps to 1200 bps, and in synchronous mode at 600 bps to 56,000 bps.

The 3705 consists of one to four modules that contain a central controller, storage, a control panel, one or two channel adapters for attachment to an IBM processor, one to four communication scanners, and the required hardware for attachment to communication lines. This hardware permits the 3705 to communicate with a variety of data communication devices.

There are two versions of the 3705. The 3705-I has core storage with a cycle time of 1.2 microseconds and is available as Models A1 (16K) through D8 (240K) with storage housed in each module in quantities of one or two 32K-byte increments. The 3705-II has monolithic

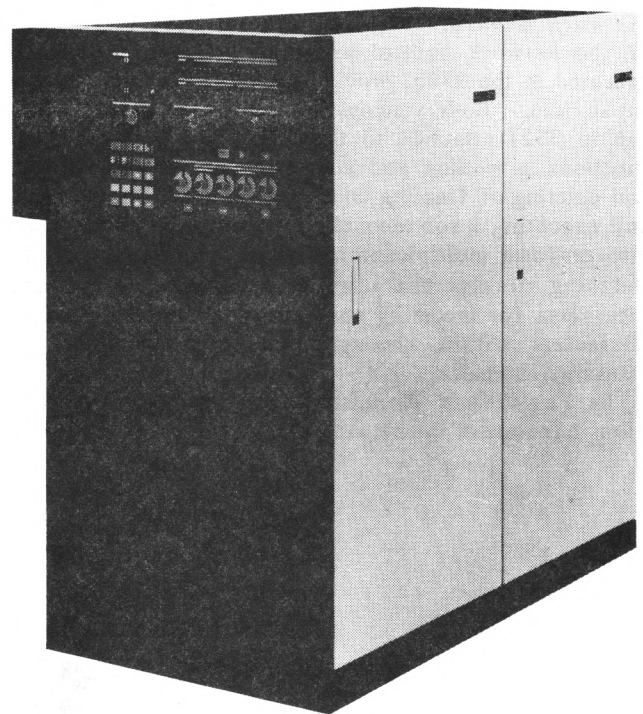

Figure 2-11. IBM 3705 Communications Controller

storage with a cycle time of 1.0 microsecond and is available as Models E1 (32K) through H8 (256K) with storage housed entirely in the first module.

The *Channel Adapter Type 3* feature (optional), with automatic two-processor switching capability for multiprocessing systems, helps to increase the accessibility of virtual multiprocessing systems. This feature allows a 3705 to operate simultaneously with two processors of a multiprocessing system.

The 3705, with appropriate programming and the remote support feature, is able to operate as a remote network concentrator, collecting data from low-speed terminals and sending it at high speed to the processor. Thus, the activity of the 3705 can be closely matched to the requirements of a data communication network.

Because data communication functions generally require highest priority in a data processing system and demand a considerable amount of time and storage space, executing these functions in the 3705 frees the processor to do more message-processing and batch-processing work.

### **Programming Support**

Programming support for the 3705 includes a basic version and a virtual storage (VS) version of both the network control program and the emulation program, as well as system support programs. When executing either version of the network control program, the 3705 requires only a single subchannel address, regardless of the number of communication lines attached.

**Network Control Program:** The basic and VS versions of the network control program, both of which are executed in the 3705, provide the 3705 with its optimal capabilities. Both versions control terminals and lines (up to 352) attached to the 3705 and perform such functions as polling and addressing of stations, adding and deleting of framing characters around message text, and executing error-recovery procedures. Both versions also perform multiplexer functions such as converting outgoing message characters to serial bit streams (and vice versa for incoming characters), recognizing control characters within message text, and checking for transmission errors.

The *Partitioned Emulation Programming Extension*, a feature of the network control program/VS, allows

the program to operate some lines in network control mode while operating other lines in emulation mode.

**Emulation Program:** The basic and VS versions of the emulation program, both of which are executed in the 3705, allow the 3705 to operate with most programs written for the 2701, without modification. In addition, both versions provide an easy conversion path from the 2701 to the 3705. With either version, the 3705 can attach as many as 255 lines.

**System Support Programs:** These programs, which are executed in a processor, generate control programs and load them into controller storage, and also dump controller storage.

## Modulator/Demodulator Units

### 2711 Line Adapter Unit

The IBM 2711 Line Adapter Unit (Figure 2-12) attaches to IBM processors equipped with an ICA feature and to IBM 3704 and 3705 Communications Controllers. Each 2711 can contain as many as 32 line adapters. The IBM line adapters modulate and demodulate signals over communication facilities in a manner similar to that of the common-carrier data sets that would otherwise be needed to perform these functions. Use of the 2711 Line Adapter Unit with IBM line adapters in lieu of common-carrier data sets offers improved flexibility of system design and economy.

Three types of line adapters can be installed. They provide facilities for:

1. Communication over limited distances (8 miles or less).
2. Communication over privately owned or leased common-carrier facilities.
3. Simultaneous sharing of a voice-grade line by as many as four low-speed terminal lines. (Each low-speed line may be operated either point to point or multipoint.)

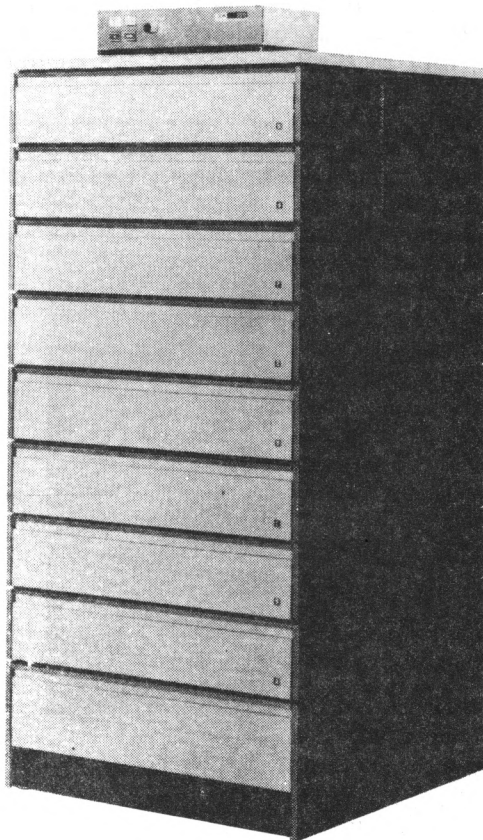

Figure 2-12. IBM 2711 Line Adapter Unit (with Maximum Number of Line Adapter Modules)

### Functional Sections

The 2711 Line Adapter Unit contains two functional sections, the line adapter module and the line adapter.

**Line Adapter Module:** Each feature provides for the attachment of four line adapters. The basic 2711 can accommodate up to four IBM line adapters. If more than four are required, up to seven additional line adapter modules can be added to provide for a total of 32 line adapters per 2711.

**Line Adapters:** Line adapters serve as modems for use on appropriate communication facilities, permitting communication with similarly equipped IBM terminals.

### 3872 Modem

### 3874 Modem

### 3875 Modem

The IBM 3872 (Figure 2-13), 3874 (Figure 2-14), and 3875 (Figure 2-15) Modems comprise a family of synchronous modems with half-speed capability that provides data communication products with the modulation/demodulation function required for transmitting data over common-carrier nonswitched voice-grade lines, equivalent privately owned nonswitched lines, or public switched telephone networks.

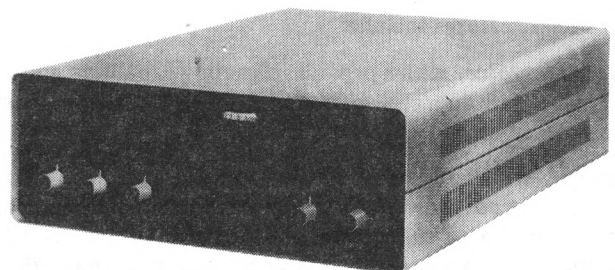

Figure 2-13. IBM 3872 Modem

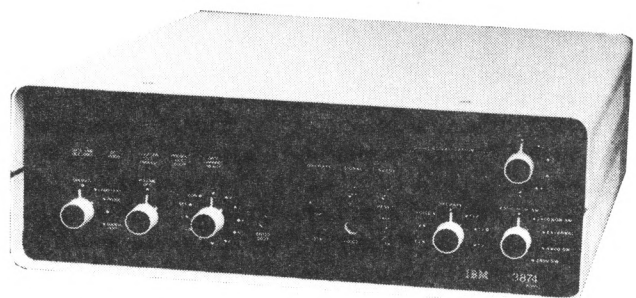

Figure 2-14. IBM 3874 Modem

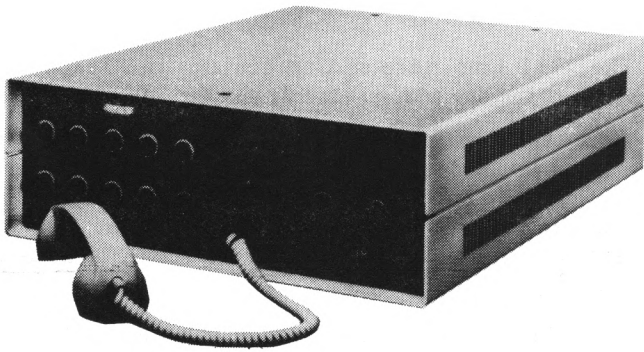

Figure 2-15. IBM 3875 Modem

These three modems can accommodate configurations which include point-to-point, multipoint, and switched network operation. The operator panel controls and indicators allow the operator to quickly localize problems by performing local and end-to-end testing.

Transmission may be full duplex, half duplex, or half speed. Speeds range from 2400 bps to 7200 bps: the 3872 transmits data at 2400 bps and 1200 bps half-speed, the 3874 transmits data at 4800 bps and 2400 bps half-speed, the 3875 transmits data at 7200 bps and 4800 bps half-speed. The three modems can be used with SDLC, BSC or IBM Type III line controls.

Optional features include:

*Alternate voice*, which provides signaling capability and a socket on the operator panel to plug in a handset for voice communication.

*Fan-out*, which allows attachment of up to three IBM data communication terminals at one location. This feature also allows up to three IBM multiplexers, or integrated communications adapters at a central site to share the same modem for backup purposes.

## Display Devices

### 3275 Display Station Models 1, 2, 11, and 12

The IBM 3275 Display Station (Figure 2-16) is a remotely attached, standalone display station. For BSC (binary synchronous communication) operating mode, the 3275 Models 1 and 2 communicate with an IBM processor via an integrated communications adapter, an IBM 2701 Data Adapter Unit, or an IBM 3704 or 3705 Communications Controller. For SDLC (synchronous data link control) operating mode, the 3275 Models 11 and 12 attach to an IBM processor via an IBM 3704 or 3705 Communications Controller.

The 3275 provides control and display of alphanumeric information on a CRT screen. The 3275 Model 1 or 11 displays up to 480 characters in 12 lines of up to 40 characters each; Model 2 or 12 displays up to 1,920 characters in 24 lines of up to 80 characters each. The EBCDIC character set is basic; 3275 Model 1 or 2 has an optional ASCII character set.

The 3275 does not require a control unit, and is appropriate for locations requiring a single display device. Transmission rates for Models 1 and 2 are 2000 and 2400 bps, with 1200, 4800, or 7200 bps rates available as options. Transmission rates for Models 11 and 12 are 2000, 2400, 4800, or 7200 bps, with 1200 bps available as an option.

The 3275 may be multidropped on the same facility with other BSC devices as tributary stations on a multipoint line with an IBM processor as the control station.

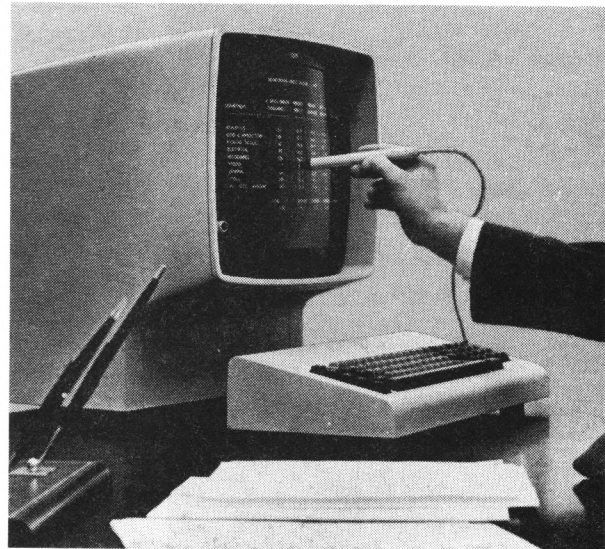

Figure 2-16. IBM 3275 Display Station



## Systems

### 1030 Data Collection System

The IBM 1030 Data Collection System (Figure 2-17) provides a fully integrated online data collection system, capable of operating within one plant or between plants. The various components of the 1030 system together form an effective management information system that diminishes the gap between the time when data is originated and the time when it becomes available for use. Some of the applications of the 1030 system include:

- Scheduling
- Dispatching
- Attendance reporting
- Inventory maintenance
- Labor distribution and performance

The 1030 system collects digital information from diverse reporting stations and transmits it at 60 characters per second to a host IBM processor for recording, processing, and analyzing.

Connection to the host IBM processor is effected via a 2701 Data Adapter Unit, a 3704 or 3705 Communications Controller, or an integrated communications adapter.

Transmission occurs over half-duplex privately-owned communication lines or common-carrier leased private lines.

Units that may be combined into a 1030 configuration include:

- IBM 1031 Input Station
- IBM 1032 Digital Time Unit
- IBM 1033 Printer (online systems only)
- IBM 1035 Badge Reader

*1031 Input Station* enables the 1030 system to accept input data in various forms; the system can accept alphameric data from standard 80-column punched cards and numeric data from punched plastic badges, manual entry units, and data cartridges. As many as 24 IBM 1031's can be attached to a 1030 system.

*1032 Digital Time Unit* provides time-of-day information for the entire data collection system.

*1033 Printer* provides online 1030 Data Collection Systems with printed output at locations remote from the host IBM processor. The 1033 Printers, in combination with 1031 Input Stations, offer full online inquiry and reply capabilities with the IBM processor.



Figure 2-17. Units of an IBM 1030 Data Collection System: IBM 1033 Printer and IBM 1031 Input Station

**1035 Badge Reader** transmits numeric data at 60 characters per second from 22-column (card-stub size) badges via a 1031 Input Station. As many as four 1035's can be connected to a 1031. Functionally, the 1035 Badge Reader units can be thought of as providing an extension of the badge reading capability of the 1031 unit with which they are associated.

### 1050 Data Communication System

The IBM 1050 Data Communication System (Figure 2-18) is a multipurpose office-oriented data communication system. This versatile system is designed for a wide range of applications in such industries as:

Transportation	Distribution
Manufacturing	Insurance
Research	Refining

In particular, the 1050 system can perform such functions as:

**Document Writing** of sales orders, insurance policies, payrolls, engineering specifications, etc.

**Direct Inquiry and Response** (real-time operation) with a central processing unit.

**Remote Printing** of business records and invoices, thus supplying to remote locations full documentation of business transactions.

**Exception Reporting** of data about work orders, credit ratings, inventory adjustments, traffic movements, etc.

**Intracompany Communication** to provide rapid distribution of memorandums, directives, administrative reports, etc.

The 1050 Data Communication System can be connected to an IBM processor via the 2701 Data Adapter Unit or the 3704 or 3705 Communications Controller. Transmission can occur at 14.8 characters per second in half-duplex mode over leased private, common-carrier switched, or privately owned telephone networks, and either directly between locations, through switching centers, or through message exchanges. The 1050 system is capable of simultaneous home-loop operation (local operation between units of the same 1050 configuration) and line-loop operation (over communication lines to another 1050 system or an IBM processor).

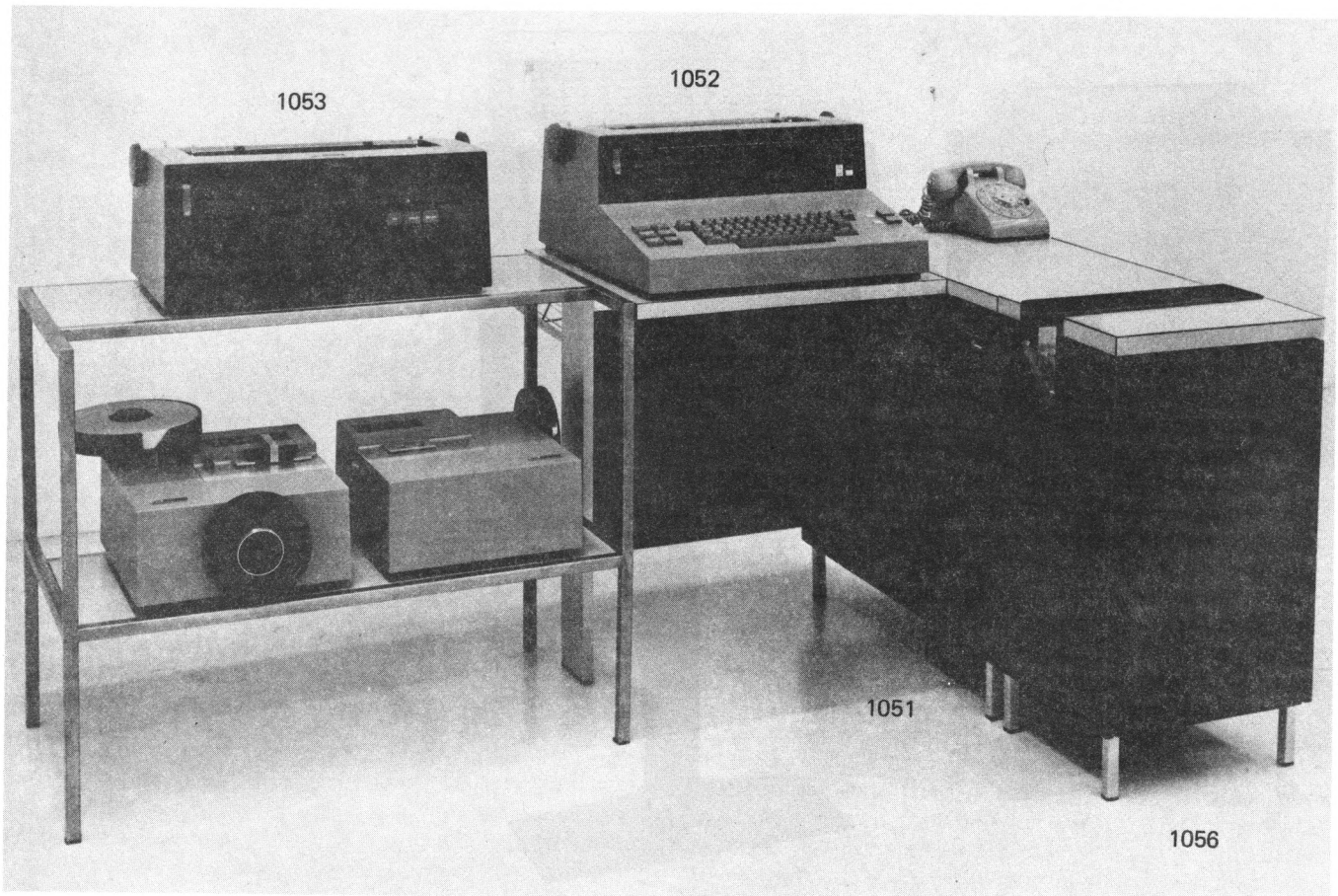

Figure 2-18. IBM 1050 Data Communication System

Data may be entered into the 1050 system by manual keying, by punched cards, by punched paper tapes, and by edge-punched documents. Output from the system may be printed documents, punched cards, punched paper tape, or edge-punched documents.

The versatility of the 1050 system is due in large part to the many configurations it may assume. The minimum configuration contains only an IBM 1051 Control Unit and a receive-only printer; configurations for a wider variety of uses may be designed from combinations of the following available components:

1051 Control Unit  
1052 Printer-Keyboards  
1053 Printer  
1054 Paper-Tape Reader  
1055 Paper-Tape Punch  
1056 Card Reader  
1058 Printing Card Punch  
1092 Programmed Keyboard

The 1051 Control Unit is required in all configurations. It contains the power supply, code translator, data channels, and control circuitry for the 1050 system. All components are electrically connected through the control unit.

### **3270 Information Display System**

The IBM 3270 Information Display System (Figure 2-19) is a family of display products that can be tailored to meet the needs of all alphanumeric display applications. It offers improved response times and transaction rates based on increased transmission and operator efficiency. In addition, the 3270 display system is easy to operate and well suited to an office environment.

The 3270 display system has outstanding configuration flexibility.

- It can be a standalone unit, a small cluster, or a large cluster (of up to 32 units).
- It can include 480-character display stations or large-capacity 1,920 character display stations or both.
- It can also include printers (40 or 66 characters per second).
- It can be attached to the channel of an IBM processor remotely via binary synchronous communication (BSC) or synchronous data link control (SDLC) line discipline (through communication facilities).
- It offers increased flexibility in the number of display stations which can be attached to each communication line, and it is compatible with other BSC or SDLC devices.

The 3270 system also has exceptional feature flexibility.

- It offers typewriter, data entry, and operator console keyboards and a selector pen.
- It provides local data transfer rates of up to 650,000 characters per second and remote line speeds of up to 7200 bits per second.

- It includes data security enhancement features, such as keylock and operator identification card reader, and the ability to enter data without displaying it.

Components of the 3270 Information Display System include:

#### ***3271 Control Unit (Remote Attachment)***

- Models 1 and 11—480-character buffer capacity.
- Models 2 and 12—1,920-character buffer capacity.
- Models 1 and 2 attach to IBM processors via modems and a BSC data link, and an integrated communications adapter or data transmission multiplexer.
- Models 11 and 12 attach to IBM processors via modems and a SDLC communication link, and a 3704 or 3705 Communications Controller.

#### ***3275 Display Station (Remote Attachment)***

- Models 1 and 11—480-character buffer capacity.
- Models 2 and 12—1,920-character buffer capacity.
- Models 1 and 2 are standalone units that attach to IBM processors via modems and data transmission multiplexers or integrated communications adapters.
- Models 11 and 12 are standalone units that attach to IBM processors via modems and an SDLC communication link, and a 3704 or 3705 Communications Controller.

#### ***3277 Display Station***

- Model 1—480-character display image.
- Model 2—1,920-character display image.
- Model 1 attaches to a 3271 Control Unit (all models).
- Model 2 attaches to a 3271 Control Unit Model 2 or 12.

#### ***3284 Printer***

- Model 1—480-character buffer capacity with a 40-character-per-second printout rate.
- Model 2—1,920-character buffer capacity with a 40-character-per-second printout rate.
- Model 3—No buffer is provided; the printout rate is 40 characters per second.
- Model 1 attaches to a 3271 Control Unit (all models).
- Model 2 attaches to a 3271 Model 2 or 12.
- Model 3 attaches to a 3275 Display Station (all models).

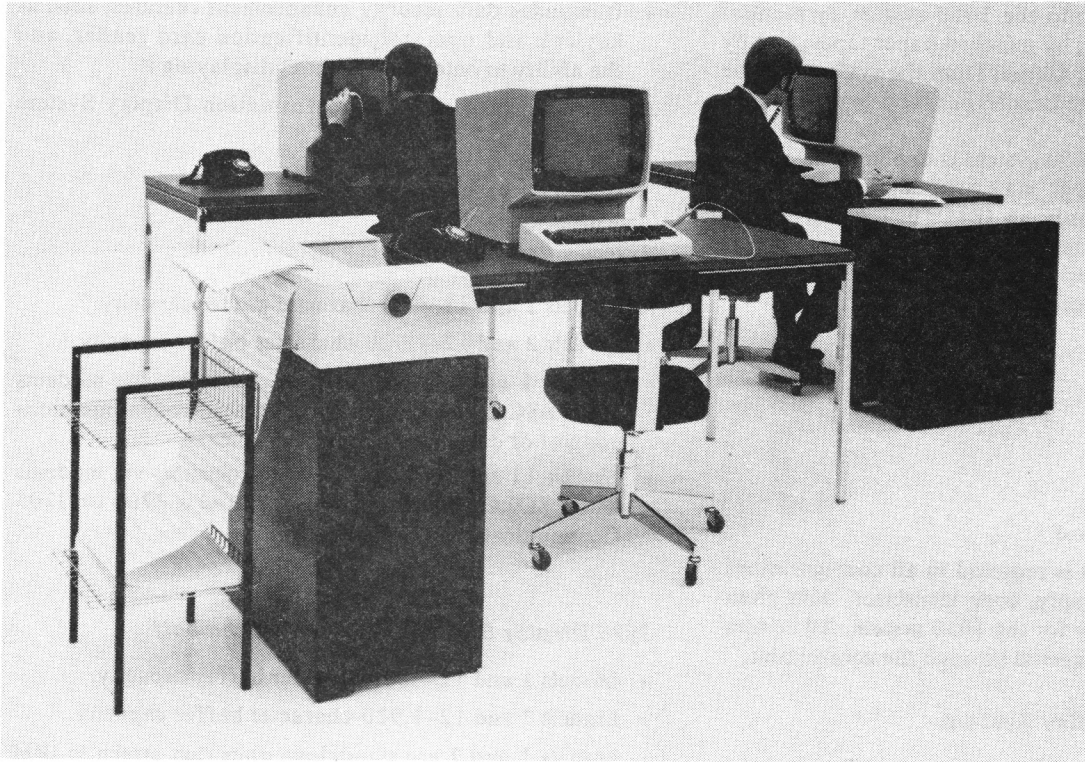

Figure 2-19. IBM 3270 Information Display System

#### **3286 Printer**

- Model 1—480-character buffer capacity with a 66-character-per-second printout rate.
- Model 2—1,920-character buffer capacity with a 66-character-per-second printout rate.
- Model 1 attaches to a 3271 Control Unit (all models).
- Model 2 attaches to a 3271 Model 2 or 12.

#### **3288 Line Printer (Model 2 Only)**

- Model 2—1,920-character buffer capacity. The print rate is 120 lines per minute.
- Model 2 attaches to a 3271 Control Unit Model 2.

A 3270 display system may attach remotely to a host IBM processor (Figure 2-20).

At least one display station with a keyboard must be attached to any control unit.

Remote attachment of a 3271 Control Unit is via modems and communication lines and data transmission multiplexer or an integrated communications adapter. Data transmission can be in BSC or SDLC mode of operation.

When using BSC operating mode to communicate with an IBM host processor, a 3270 display system can be remotely attached to the data communication network with a 3271 Control Unit Model 1 or 2, or with a 3275 Display Station Model 1 or 2.

The 3271 Control Unit Model 1 can attach up to 32 of the following units:

- 3277 Display Stations Model 1
- 3284 Printers Model 1
- 3286 Printers Model 1
- 3287 Printers Model 1 or 2

The 3271 Control Unit Model 2 can attach up to 32 of the following units:

- 3277 Display Stations Model 1 or 2
- 3284 Printers Model 1 or 2
- 3286 Printers Model 1 or 2
- 3287 Printers Model 1 or 2
- 3288 Line Printers Model 2

As in local configurations, at least one display station with a keyboard must attach to any control unit.

A standalone remote display system, the 3275 Display Station Model 1 or 2, provides added convenience for locations that require a single display device. The 3275 does not require a control unit to communicate with an IBM processor. The 3275 Display Station can be expanded by attaching a 3284 Printer to provide a paper copy of computer messages. The 3275 Display Station Model 1 or 2 can be attached (multidropped) to the same remote communication line as other 3270 display systems and other IBM products that use the BSC mode of operation, or the 3275 can operate on a switched communication line, using the Dial feature.

Remote Information Path

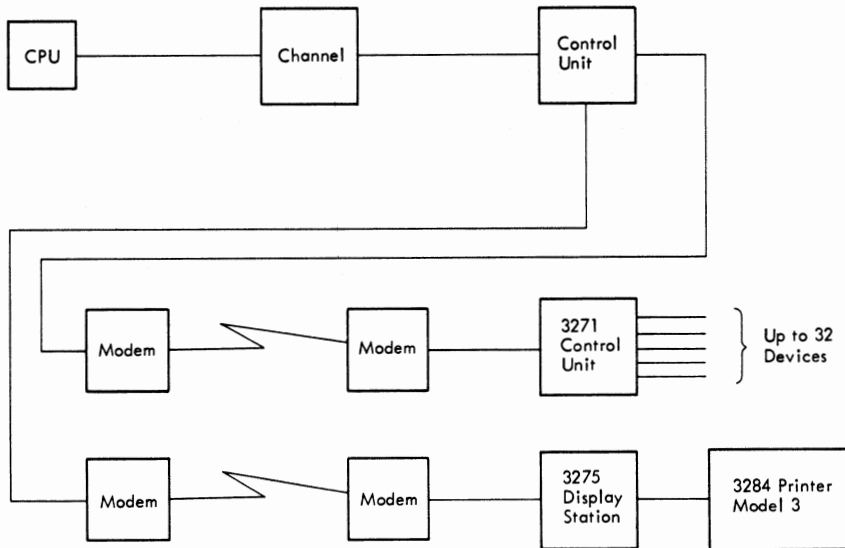

Figure 2-20. Remote Information Path for IBM 3270 Information Display System

When using SDLC operating mode, a 3270 display system is remotely attached to an IBM processor via a 3271 Control Unit Model 11 or 12, or a 3275 Display Station Model 11 or 12.

The 3271 Control Unit Model 11 directs the operation of up to 32 attached units of the following:

- 3277 Display Stations Model 1
- 3284 Printers Model 1
- 3286 Printers Model 2
- 3287 Printers Model 1 or 2

The 3271 Control Unit Model 12 can attach up to 32 units of the following:

- 3277 Display Stations Model 1 or 2
- 3284 Printers Model 1 or 2
- 3286 Printers Model 1 or 2
- 3287 Printers Model 1 or 2
- 3288 Line Printers Model 2

At least one display station with a keyboard must attach to any control unit. The 3275 Display Station Model 11 or 12 does not require a control unit for attachment to the data communication network. A 3284 Printer Model 3 can be attached to the 3275 Display Station when a paper copy of the computer message is desired. The 3275 Display Station Model 11 or 12 can be attached to the same remote communication line as other 3270 systems and other IBM products that use the SDLC mode of operation.

### 3600 Finance Communication System

The IBM 3600 Finance Communication System (Figure 2-21) consists of a programmable controller and a selection of compact terminals and associated devices. The 3600 communicates with an IBM processor via SNA (systems network architecture), and can be configured to accommodate the requirements of a variety of users. Bank tellers, for example, can use it to debit or credit checking and savings accounts, to post interest, and to record loan payments; management can use it to maintain a record of cash flow through an institution; customers can use it for self-service banking at any hour.

Components of the system include:

- 3601 Finance Communication Controller
- 3603 Terminal Attachment Unit
- 3604 Keyboard Display Models 1, 2, 3, and 4
- 3606 Financial Services Terminal
- 3608 Printing Financial Services Terminal
- 3610 Document Printer Models 1, 2, and 3
- 3611 Passbook Printer Models 1 and 2
- 3612 Passbook and Document Printer Models 1, 2, and 3
- 3614 Consumer Transaction Facility Models 1 and 2
- 3618 Administrative Line Printer

The IBM 3601 Finance Communication Controller, a device with as much as 40K bytes of programmable storage, can supervise the 3600's terminals and associated devices, and can control data transmission between the 3600 system and an IBM processor. The 3601 uses synchronous data link control (SDLC) for improved communication efficiency, and has a removable diskette for storing user data and programs as well as control and diagnostic data.

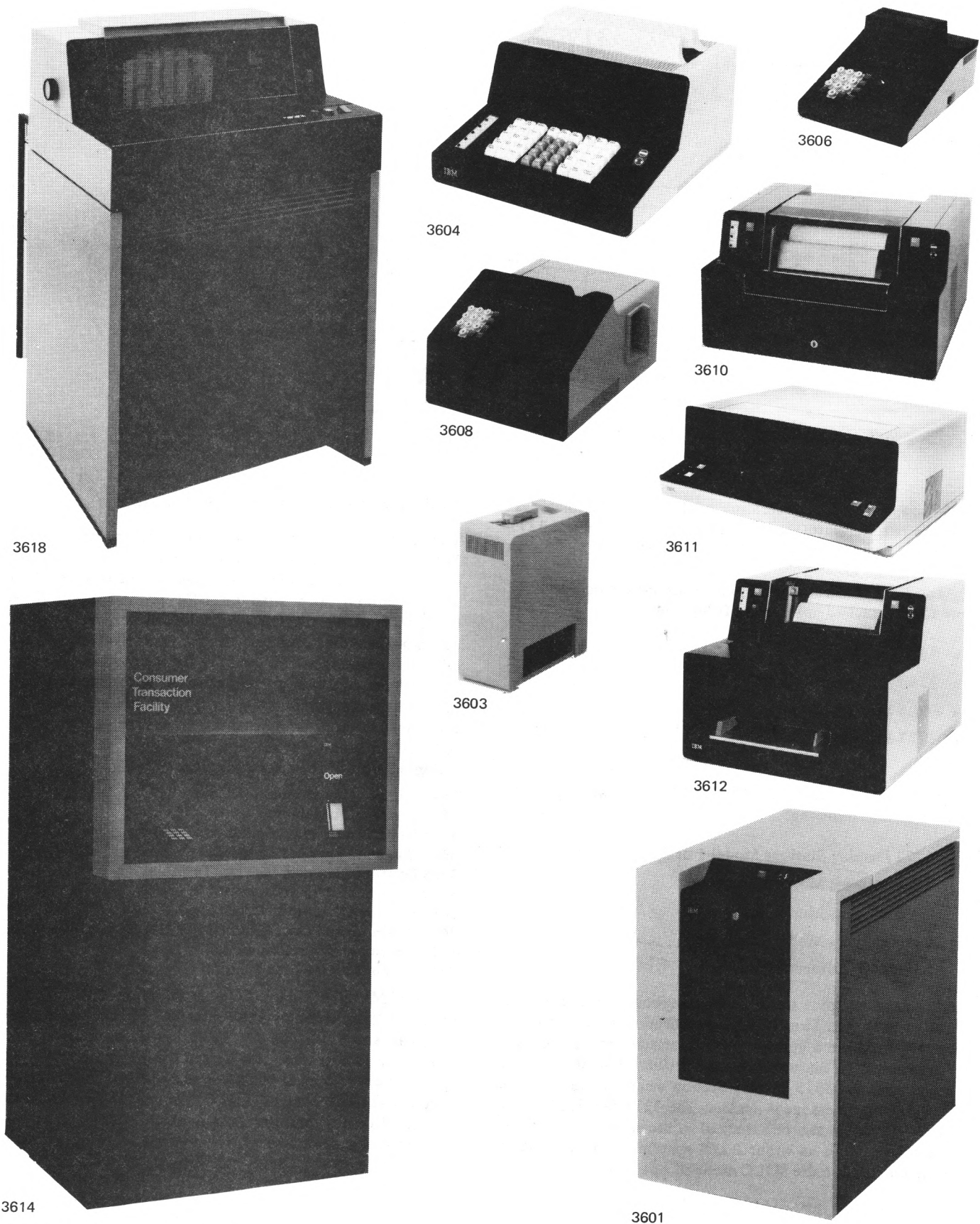

Figure 2-21. Components of IBM 3600 Finance Communication System (Design Models)

Special features for the 3601 include an optional integrated 1200-bps modem.

The IBM 3603 Terminal Attachment Unit is used for remote loop attachment of the IBM 3606 Printing Financial Services Terminal and the IBM 3608 Printing Financial Services Terminal to the 3601 Finance Communication Controller. It has self-checking facilities on a local loop and can use a public switched network if the normal nonswitched communication line fails.

The IBM 3604 Keyboard Display, a compact interactive terminal, can be used for a variety of applications, including deposit and withdrawal transactions, customer account inquiry, and calculation verification.

The 3604 has an easy-to-read display and a choice of keyboards. The maximum number of characters that can be displayed is 240 for Models 1 and 2, 480 for Model 3, and 1,024 for Model 4. The display allows visual check of keyed data prior to transmission or printing and can provide operator guidance messages for training or for complex or infrequent transactions. The 3604 can have one of four keyboards—numeric, alphameric, or expanded numeric or alphameric. All four keyboards have function keys whose use is assigned by the user through the application programs in the 3601 controller.

Special features for the 3604 include a magnetic stripe reader or encoder/reader. The reader can read data such as a teller's security code or a customer's account number from a magnetic stripe on a customer's card or passbook. The encoder/reader can encode information on a passbook stripe, as well as read it.

The IBM 3606 Financial Services Terminal has a keyboard that includes ten numeric and six function keys, an eight-digit numeric display that shows data as it is keyed, nine indicator lights that signal transaction results and terminal status, and a magnetic stripe reader that reads the coded stripe on plastic identification cards.

The 3606 allows financial institutions to extend their online service to their branch offices or to their customer's point-of-sale locations. At the branch office, it may be used by tellers in paying and receiving functions or by customers in checking their account status. At point-of-sale locations, it may be used for customer identification, customer account status checking, funds transfer, and data capture.

The IBM 3608 Printing Financial Services Terminal has all of the functions and features of the 3606 plus an alphameric (45-character set) printing capability of up to three lines. An entry chute on the right side of the terminal allows insertion of sales slips and other documents for printing.

The IBM 3610 Document Printer is used for printing tasks such as document validation, checks, statements, low-volume reports, printouts for error tracking, and audit trails. When a 3610 is combined with a 3604, the two together form an administrative or teller work station.

Using a 64-character set, the 3610 prints at a rate of 15 characters per second, printing 10 characters per inch on lines up to 80 characters long, with vertical spacing of five or six lines per inch.

The 3610 is available in three models. All three can print on cut-form documents. Additionally, the Model 2 can print on journal rolls, and the Model 3, can print on continuous forms. Paper widths can be 4.0 to 9.25 inches for cut-form documents, 4.0 to 8.5 inches for journal rolls, and 9.5 inches (9.0 inches between margin-punch centers) for continuous forms.

Special features for the 3610 include a 96-character set that allows printing at a rate of 30 characters per second, and a feature that permits a 3610 to be shared by two tellers.

The IBM 3611 Passbook Printer Models 1 and 2 each print one or more lines of up to 100 characters on a horizontal- or vertical-fold passbook placed in the passbook chute of the printer. Model 1 prints passbooks and padded cut forms of identical length and width, and of specified dimensions. Model 2 prints passbooks and single- or multiple-part documents of varied size within a maximum width dimension.

The 3611 prints 12 characters per inch and is available with vertical line spacing of either five or six lines per inch. It can have either a 64-character set for printing at a rate of 15 characters per second or a 96-character set for printing at a rate of 30 characters per second. A feature that permits two tellers to share the same 3611 is also available. A 3611 and a 3604 Keyboard Display placed together form an administrative or teller work station.

The IBM 3612 Passbook and Document Printer has two printing mechanisms—one for passbooks, the other for cut-form documents. When a 3612 is combined with a 3604, the two together form a full-function teller work station for handling a wide range of transactions.

A basic 3612 has a 64-character set and prints 15 characters per second. The passbook mechanism prints information on horizontal- or vertical-fold passbooks, 12 characters per inch on a 100-character line, and the document mechanism prints 10 characters per inch on an 80-character line. Vertical spacing for both mechanisms is either five or six lines per inch.

The 3612 is available in three models, all of which can print in passbooks and on cut-form documents. In addition, the Model 2 can print on journal rolls, and the Model 3 can print on continuous forms.

Special features for the 3612 include a 96-character set that allows printing at a rate of 30 characters per second, and a feature that permits sharing of the printer by two tellers.

The IBM 3614 Consumer Transaction Facility, an online banking terminal, allows customers self-service access to their accounts. Using a 3614, a customer can withdraw cash from his account, make deposits, check his account's status, and perform other transactions programmed by the financial institution.

An optional depository feature allows a customer to make deposits or pay certain bills; the optional transaction statement printer gives the customer a printed record of these transactions.

Two models are available. The Model 1 is for inside use, as in a lobby, and the Model 2 is for outside use, mounted in a wall. The Model 2 allows a 3600 system to be available on a 24-hour basis.

To use a 3614 a customer needs a special identification card and an identification number. When the card is inserted, the customer can use the display and keyboard to direct the transaction. The 40-character display tells the customer how to use the system and how to correct operation errors, and supplies him with requested information about his account, but no one else's. The 3614 can retain stolen cards, and can signal an alarm system when tampered with.

The IBM 3618 Administrative Line Printer, a compact medium-speed device, can handle a variety of items, such as trial balances, exception notices, customer statements, transaction journals, and management reports.

Using the 48-character set, the 3618 can print at speeds up to 155 lines per minute. Other sets available have 64 and 96 characters, with print rates as high as 120 and 80 lines per minute, respectively.

The basic 3618 prints 10 characters per inch on lines up to 80 characters in length, with vertical spacing of six lines per inch on pin-fed continuous-form paper.

Special features for the 3618 include an expanded print line and dual independent forms feed. The first feature expanded the print line to 132 characters on a 13.2-inch line. The second feature provides two independently indexed pin-feed mechanisms which enable different-size forms to be handled concurrently.

### 3650 Retail Store System

The IBM 3650 Retail Store System (Figure 2-22) is a comprehensive system that can handle point-of-sale transactions, data entry and inquiry, report printing, and merchandise receiving and marking.

Online connection to an IBM processor via SNA (systems network architecture) enables the 3650 system to operate on an interactive or batch basis with other data processing applications.

Components of the 3650 system include:

- 3651 Store Controller Model A50 or Model B50
- 3653 Point of Sale Terminal
- 3657 Ticket Unit
- 3659 Remote Communications Unit
- 3275 Display Station Model 3
- 3284 Printer Model 3
- 3784 Line Printer

The IBM 3651 Store Controller Model A50 or Model B50 is the controlling link between the IBM processor and the point-of-sale, receiving-marking, credit authorization, and management operations of the store. Model A50 differs from Model B50 in integral disk storage capacity: Model A50 has a 5-megabyte capacity, and Model B50 has a 9.3-megabyte capacity. The 3651 collects data from the various parts of the system, performs edit, logical, and arithmetic operations, and then stores and/or forwards the data to its destination in the system. It communicates by way of a store loop with the various terminals on an interactive basis, processes inquiries against various files,

and communicates with the IBM processor on a batch or interactive basis. The basic transmission rate is 2400 bps over leased or switched networks.

The 3651 provides for point-of-sale functions and basic terminal support. The functions include basic sales and logging support, negative in-store credit, support of the I/O devices, and basic interfaces for user program execution.

The 3651 uses synchronous data link control (SDLC) for improved communication efficiency, and has both control storage and integrated disk storage.

The IBM 3653 Point of Sale Terminal has a keyboard, a three-station printer, an operator guidance panel, a transaction display, a cash drawer with a removable till, and a store loop adapter for communication with a 3651.

The keyboard is the normal input device for recording customer transactions. An optional wand reader permits a 3653 to read magnetically encoded tickets, credit cards, and employee badges; and the three-station printer allows a 3653 to issue cash receipts, put out a journal of transactions, and print on inserted documents.

The operator guidance panel has 20 short descriptive messages which are backlighted, one at a time or in combination as needed, to provide operators with step-by-step instructions.

The transaction display is a composite of an eight-position numeric display plus the symbols

\$, .

with five backlit captions, and shows numeric data as it is being keyed and/or calculated. The display provides the operator with visual verification of output.

The IBM 3657 Ticket Unit is an online high-speed batch ticket encoder that can also batch-read 2-inch tickets. Tickets are 1 inch wide by 1, 2, or 3 inches long, and contain a 1/4-inch-wide magnetic stripe. The 3657 encodes this stripe with up to 19, 40, or 60 characters of data readable by the 3657 batch-read function or by the wand available for the 3653. The 3657 also prints up to 22, 42, or 64 characters of visually readable data in two lines on tickets.

The IBM 3659 Remote Communications Unit, a 2400-bps signal converter, provides store-loop capability to retail establishments that are remote from a 3651. The 3659 interfaces with leased-line facilities for data transmission, and with the store loop for retail store operations.

The IBM 3275 Display Station Model 3 is a 1,920-character alphameric display station with a keyboard. The 3275 can be used for a variety of operations, such as entering purchase orders, controlling and checking merchandise received, controlling ticket production and price changes, and making inquiries to a 3651 or to host system files for many other inventory, credit, and management control functions needed to efficiently operate a retail store.

The IBM 3284 Printer Model 3 can be attached to a 3275-3 for printing such data as store reports, due-in orders, and receiving lists. The 3284 is a wire matrix printer that prints at 40 characters per second.





3653

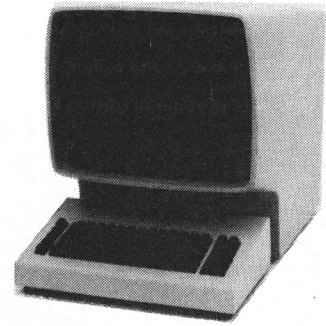

3275-3

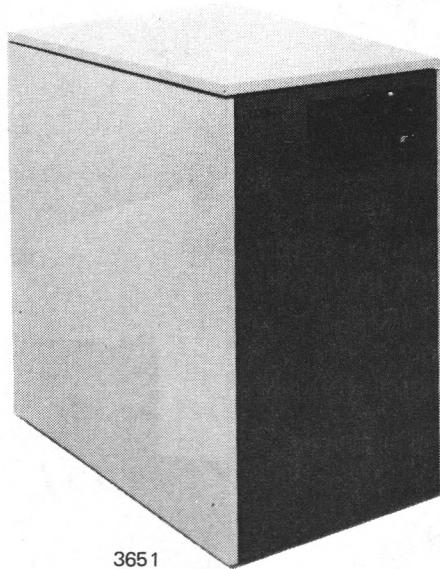

3651

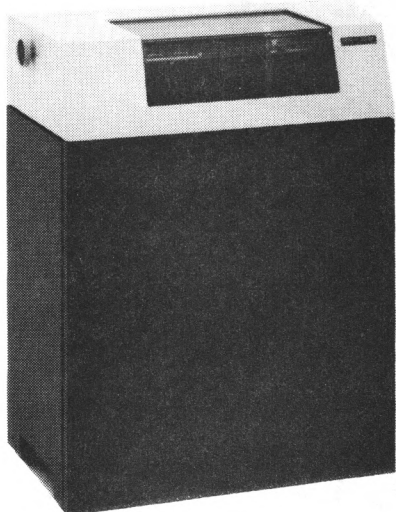

3284-3

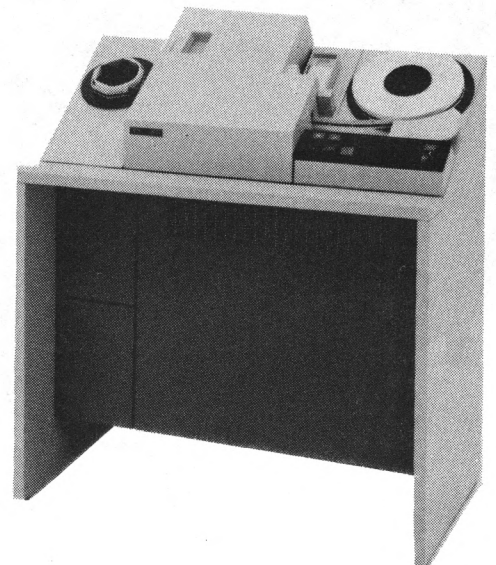

3657

Figure 2-22. Components of IBM 3650 Retail Store System (Design Models)

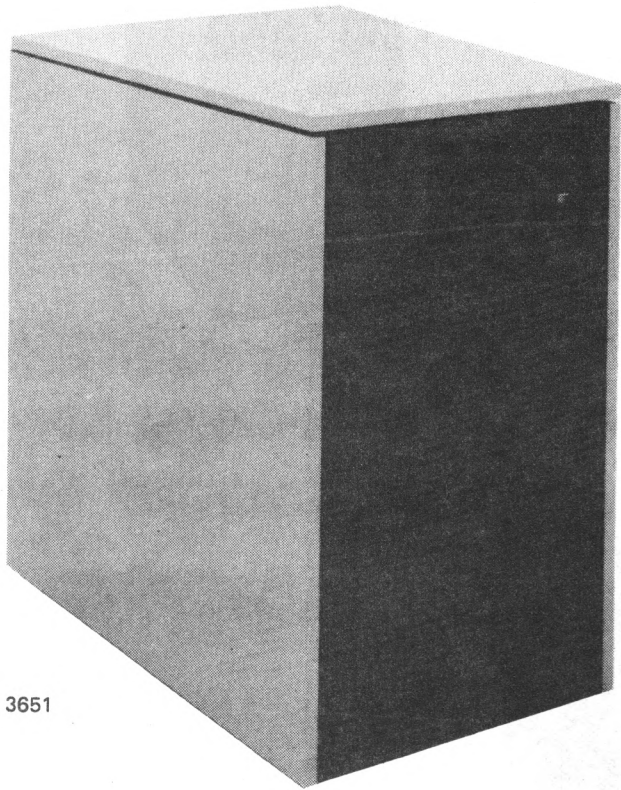

3651

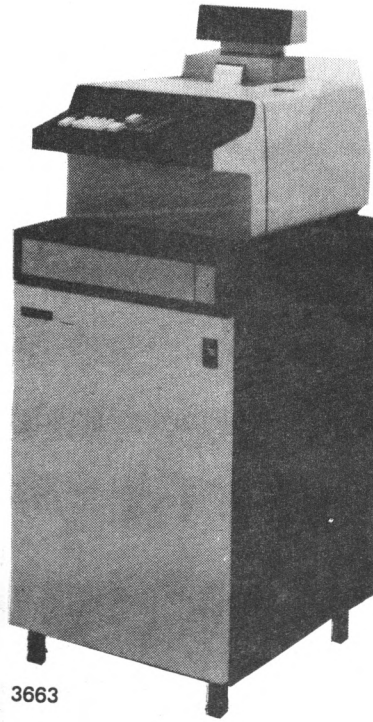

3663



3661

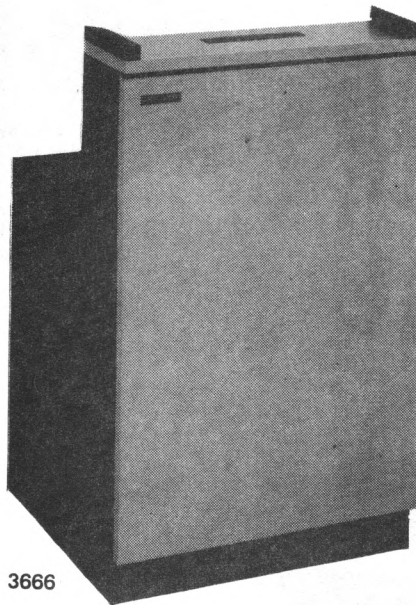

3666

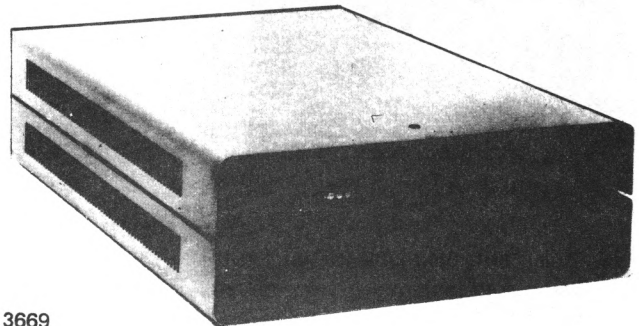

3669

Figure 2-23. Components of IBM 3660 Supermarket System (Design Models)

The IBM 3784 Line Printer can be attached to the 3651 Store Controller Model A50 or B50 for faster output than by attaching the 3284 Printer. The 3784 prints a maximum of 155 lines per minute, using a 48-character set on a metal print belt.

### 3660 Supermarket System

The IBM 3660 Supermarket System (Figure 2-23), available as either the IBM 3660 Supermarket Scanning System or the IBM 3660 Supermarket Key-Entry System, performs normal checkout operations and meets the data collection and dissemination needs of the supermarket industry. The system speeds customer checkout, increases personnel productivity, and improves customer service. The 3660 system also accumulates data from customer checkout and various store operations, which can be transmitted over appropriate communication facilities to an IBM host processor at a remote location, for analysis and report generation. These reports provide information required for ordering stock items, allocating shelf space, pricing merchandise, scheduling labor, planning weekly sales, managing the store, and maintaining good customer relations.

Components of the 3660 system include:

- 3651 Store Controller Model A60 or Model B70 (for scanning system)
- 3661 Store Controller (for the key-entry system)
- 3663 Supermarket Terminal Model 1 or Model 2
- 3666 Checkout Scanner
- 3669 Store Communication Unit

The *IBM 3660 Supermarket Scanning System* speeds customer checkout through electronic scanning of the Universal Product Code printed on purchased items. It consists of one IBM 3651 Store Controller Model A60 or B60; as many as 24 of the IBM 3663 Supermarket Terminals Models 1 and 2 (a maximum of 12 of each model), each of which can have an IBM 3666 Checkout Scanner attached; and one IBM 3669 Store Communications Unit. Connection is by a two-wire loop.

The *IBM 3660 Supermarket Key-Entry System* offers the advantages of the 3660 to enterprises that do not require the capacity and throughput of the IBM 3660 Supermarket Scanning System. The key-entry system consists of one IBM 3661 Store Controller with one or two locally attached IBM 3663 Supermarket Terminals Model 2 and may have additional 3663 Models 1 and 2 connected by a store loop. A maximum of twelve 3663 terminals can be attached to a 3661.

The store controller in the 3660 Supermarket Scanning or Key-Entry System controls the operation of all supermarket terminals and provides the communication

link between the store and the host IBM processor on a batched basis. This unit has data communication, logic, and computational capabilities, and contains data for:

- Items records such as department number, and data for pricing (single price or multiprice, mix or match), tax, and stamps.
- Check verification records to control check cashing.
- Operator records with a user-assigned password and table of store support procedures permitted.
- Item movement summary data of accumulated statistics for predesignated items sold during a defined period.
- Reconciliation records containing the total transaction dollars for each operator and the store office.
- Station productivity data.
- Miscellaneous log entries for special events such as price and check verification overrides, cancels, refunds, and discounts.

The main difference in the controllers for the 3660 scanning and key-entry systems is in their storage capacities.

The *IBM 3651 Store Controller Model A60* (with 5 megabytes of integral storage) or *Model B60* (with 9.3 megabytes of integral storage) supports electronic product code scanning and maintains up to 22,000 item records, up to 24,000 check verification records for positive or negative verification control, and up to 200 operator records. The 3651 provides station productivity data in 15-minute increments.

The *IBM 3661 Store Controller* maintains up to 1,275 item records. The number of check verification records (limited to negative type) and operator records that can be maintained depends on the number of item records. The 3661 provides station productivity data in one-hour increments.

The *IBM 3663 Supermarket Terminal Model 1 or Model 2* provides the input and output facilities required for a supermarket checkout station. It replaces and extends the function of a supermarket register. Model 1 contains the control segment and I/O equipment. The I/O equipment consists of a keyboard that can be ordered in one of several key arrangements, a cash drawer, a display, and a printer that can be ordered with a document insert feature (optional). One Model 2 attaches to a Model 1 and contains only the I/O equipment. The 3663 is available as an integrated station, as shown in Figure 2-23, or as a distributed station. In the distributed station configuration, all units are packaged separately to allow maximum flexibility in checkstand design.

The *IBM 3666 Checkout Scanner* is an optical recognition device designed to read the Universal Product Code symbols (Figure 2-24) on items as they are pulled across the scanner slot in the checkstand. Item symbols are read at a rate of up to 100 inches per second as they are moved across the scanner window. The scanner improves checker productivity and accuracy, and provides automatic recording of item movement data.



Figure 2-24. Universal Product Code Symbols

The *IBM 3669 Store Communications Unit* provides communications for the 3660 Scanning System with a host IBM virtual storage processor and with a predesignated supermarket when backup is required to continue store operation. When the backup operation is terminated, the 3669 continues communicating with the predesignated supermarket until data reconciliation has been completed. Data is transmitted over common-carrier, switched, voice-grade lines at 2400 bps. The 3669 has an automatic answering facility.

### 3740 Data Entry System

The IBM 3740 Data Entry System (Figure 2-25), designed for use in centralized, decentralized, and remote key-enter operations, is a group of related devices that use the IBM diskette as the recording medium.

The diskette used by the 3740 (Figure 2-26) is a single magnetic disk, sealed in a plastic jacket about 8 inches square. It weighs less than 2 ounces, is reusable, is

interchangeable with other diskette units, and can be easily corrected and updated.

The diskette can store as many as 1,898 128-character records, equivalent to as many characters as can be put on 3,036 80-column cards. Up to 19 data sets, each of which may be a different logical record length, can be entered on one diskette.

The size, capacity, and portability of diskettes make them a convenient storage medium for data bases of appropriate size, and with the search capabilities of the 3740 system, diskettes can readily be used for local or remote inquiry.

The components that make up a 3740 system include:

- 3741 Data Station Models 1 and 2
- 3741 Programmable Work Stations Models 3 and 4
- 3742 Dual Data Station
- 3713 Printer
- 3715 Printer
- 3717 Printer
- 3747 Data Converter

All four models of the IBM 3741 have a 64-character alphameric keyboard, a 240-character display, a diskette drive, and a microprogrammed control unit. When in use they provide:

- Operator guidance, which features CRT-displayed messages to guide the operator step by step through each field transaction.
- Program chaining, which enables the operator to key a logical record as large as 1,280 characters.
- Variable record lengths of up to 128 characters.
- Ten program levels which provide automatic functions such as skipping, duplicating, and field definition.

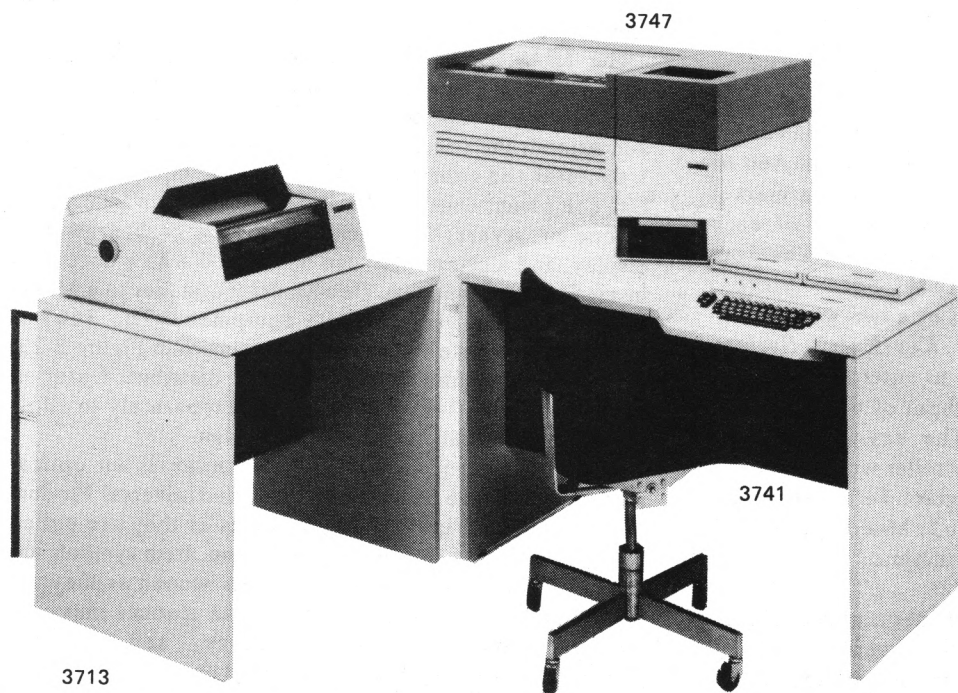

Figure 2-25. IBM 3740 Data Entry System



Figure 2-26. IBM Diskette

- End-of-data search to the last record when resuming a suspended job.
- Search by track and sector address.
- Search by comparing a search argument to the contents of a record.

In operation, data enters buffered storage prior to being recorded on a diskette. This allows for correction of detected errors before writing the record. Six 40-character lines of data, including a 30-character prompting field, can be displayed. The 3741-1, designed for use in decentralized operations, operates offline only.

The IBM 3741 Data Station Model 2 differs from the Model 1 in that it is equipped with a binary synchronous communication (BSC) adapter, which permits half-duplex point-to-point data communications between a 3740 system and an IBM processor.

Optional features for 3741 Models 1 and 2 make it possible to: verify and correct in verify mode, total fields online, perform self-check of modules 10 and 11 numbers for accuracy in keying selected numbers, initialize diskettes, add a second diskette drive, and attach a 3713, 3715, or 3717 Printer.

The IBM 3741 Programmable Work Station Models 3 and 4 operate in two modes: as a fixed function data station like the 3741 Models 1 and 2, or under control of a

program written in Application Control Language (ACL). Program control provides capacity for arithmetic operations, data manipulation and reformatting, logical branching, table building and lookup, flexible control of input/output devices, editing, file search by address, accessing of up to four disk data sets at one time, and writing on a second diskette. An optional language translator converts source statements into executable code. Program control allows printing to overlay keying, thereby increasing throughput.

The IBM 3741 Model 4, like the Model 2, is equipped with a binary synchronous communication adapter for data communications in data station mode.

Both models of the 3741 have buffered storage into which data is keyed prior to recording on a diskette, thus allowing for correction of detected errors prior to writing the record. Both models can display six lines of data, with up to 40 characters in each line. The two models differ in that the Model 2 is equipped with a binary synchronous communication (BSC) adapter, which permits half-duplex point-to-point data communications between a 3740 and an IBM processor. The 3741-1, designed for use in decentralized operations, operates offline only.

The IBM 3742 Dual Data Station has two keyboards, two drives, a display unit with two displays, and a shared microprogrammed control unit. It is designed for use in centralized high-production areas and operates offline only.

The IBM 3713 Printer can provide printed copy at a rate of 40 characters per second from keyed data or from data received by a 3741-2 from an IBM processor via a data communication line. Individual records or an entire data set can be printed; the latter may be continued from one diskette to another without interruption.

Maximum line length is 128 characters. If equipped with the adjustable margins feature, the 3713 can handle 12 form widths that range from 7-1/2 to 13-7/8 inches.

Formatting can be controlled locally by programs loaded in the 3741 program buffers, or remotely by use of control characters intermixed with data from a host processor.

The 3713 has a complete vertical and horizontal format control and can rearrange fields within records, print fields selectively, suppress or print leading zeros, replace leading zeros with asterisks, and print negative numbers with a sign.

The IBM 3715 Printer is available in two models, each using a matrix print mechanism that will print left-to-right and right-to-left. Model 1 produces copy at 40 characters per second and Model 2 at 80 characters per second. It has the functional and formatting capabilities of the 3713 Printer and can also: insert floating dollar signs, decimal points, and slashes; automatically print page heads and numbers; automatically insert store constants; expand compressed data streams; chain format instructions through program levels; and print disk addresses with each record.

The IBM 3717 Printer is a line printer with the same functional, formatting, and editing capabilities as the 3715 Printer, but it operates at a faster rate. The 3717

prints as many as 155 lines per minute using a 48-character print belt, and as many as 120 lines per minute using a 64-character print belt.

The IBM 3747 Data Converter is a buffered high-speed unit used primarily to convert batched data from diskettes to 1/2-inch magnetic tape. As many as 20 diskettes can be loaded at a time. Feeding, reading, and stacking are automatic, and the hopper can be reloaded without interrupting operations. The 3747 can convert about 300 records per minute. When equipped with a communications adapter, the 3747 can provide for half-duplex point-to-point data communications between a 3740 and an IBM processor.

### 3770 Data Communication System

The IBM 3770 Data Communication System (Figure 2-27) is a family of communication terminals that offers keyboard and printer combinations, with a selection of I/O equipment and communication features. This system provides systems network architecture (SNA) with a variety of multiple-purpose terminal configurations.

Terminals of the 3770 Data Communication System include:

- 3771 Communication Terminal Models 1, 2, and 3
- 3773 Communication Terminal Models 1, P1\*, 2, P2\*, 3, and P3\*
- 3774 Communication Terminal Models 1, P1\*, 2, and P2\*
- 3775 Communication Terminal Models 1 and P1
- 3776 Communication Terminal Models 1 and 2
- 3777 Communication Terminal Model 1)

\*Models with a *P* designation are user programmable for one or more operations.

The 3770 communication terminals are desk console style and offer:

- Communication features for operation over switched lines at rates of up to 2400 bps or over nonswitched lines at rates of up to 4800 bps (9600 bps for the 3777)
- Synchronous data link control (SDLC)
- Binary synchronous communication (BSC)
- Dual 256-byte buffering with buffer edit for the 3771-3775; dual 256- and 512-byte buffering with buffer edit for the 3776 and 3777
- Electronic horizontal and vertical print forms control (except on programmable models)
- Automatic answering on switched communication lines
- Terminal identification

The range of 3770 system operation covers: online-batch, online-interactive, offline, and dual data-path operation. For a given installation, the choice

of terminal models, features, and attached I/O equipment determines the operational limits within the range of operation.

Each 3770 terminal has an associated printer, integral (3771-3776) or standalone (3777), that prints a 132-position line at ten characters per inch. Models differ from one another in: printer type and print speed, features such as diskette and display, operations that can be user-programmed (P-models), and I/O equipment that can be attached; these characteristics are compared in Figure 2-28.

Input and output devices attachable to one or more 3770 terminals are:

The *IBM 2502 Card Reader*, which reads 80-column cards at speeds up to 150 cards per minute (Model A1), up to 300 cards per minute (Model A2), or up to 400 cards per minute (Model A3). Special features permit the electronic reading of 51-or 80-column cards or of 66- or 80-column cards; or the optical reading of marked data, except on the 3777.

The *IBM 3203 Printer Model 3*, which uses the train printing principle to produce high-quality printing, and prints up to 1000 lines per minute using a 48-character set cartridge. The 3203 supports 15 different selectable graphic sets, which may be optimized to the user's requirements. Print speed depends on the character arrangement of the cartridge in use.

The *IBM 3501 Card Reader*, which reads 80-column cards at 50 cards per minute (maximum). This compact unit is suitable for desk-top use.

The *IBM 3521 Card Punch*, which punches 80-column cards at 50 cards per minute (maximum). Special features permit card reading, or card punching with checking; and card printing.

The *IBM 3782 Card Attachment Unit*, which provides facilities and mounting for attaching the 2502 or the 3521 to any 3770 terminal except the 3777.

The *IBM 3784 Line Printer*, which provides the second-printer function when attached to the 3774. The 3784 is an engraved-font printer with an interchangeable print belt, a variable-width forms tractor, paper-jam detection, and 132 print positions. The maximum printing rate is 80 lines per minute with a 94-character set print belt, 120 lines per minute with a 64-character set print belt, or 155 lines per minute with a 48-character set print belt.

The 3770 Data Communication System communicates with an IBM processor, over the appropriate communication lines, via a 3704 or 3705 Communications Controller, a 2701 Data Adapter Unit, or an integrated communications adapter.

3521

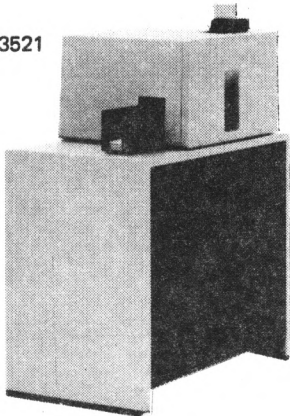

3782

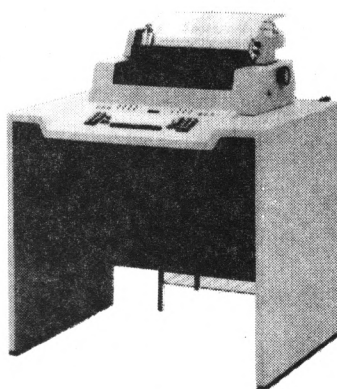

3771

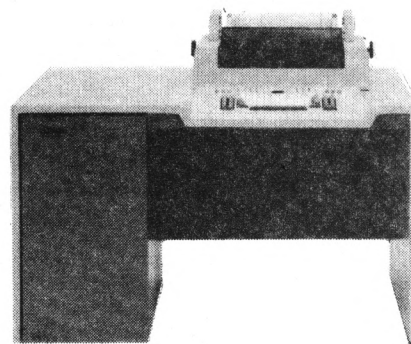

3773

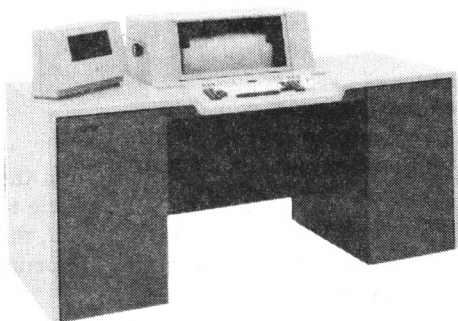

3774

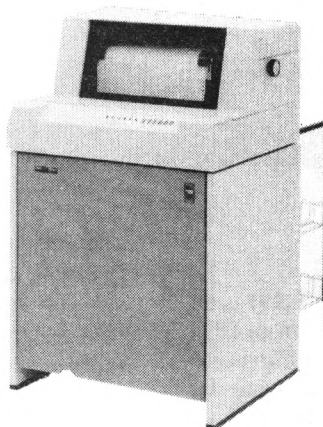

3784

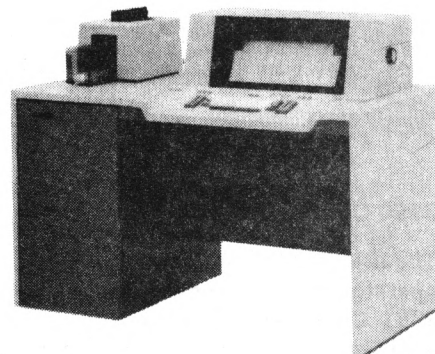

3775

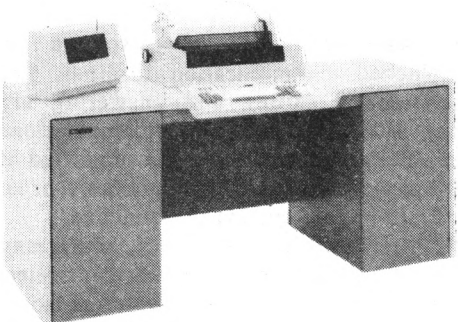

3776

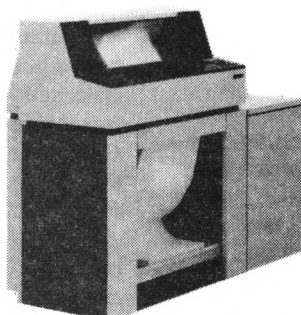

3203-3

2502

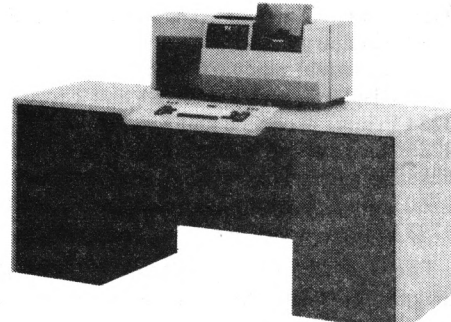

3777

Figure 2-27. Components of IBM 3770 Data Communication System (Design Models)

Terminal		Integrated Printer	Printer Type	Print Speed (Maximum)	Line Spacing per Inch	Standard Diskette	Optional Diskette (1 or 2)	User-programmable functions supported	480-character Display Feature	Attachable I/O					
Number	Model									2502	3203	3501	3521	3782	3784
3771	1	X	wire matrix**	40 cps*	6	--	--	--	--	--	--	X	X	X	--
	2	X	wire matrix**	80 cps	6	--	--	--	--	--	--	X	X	X	--
	3	X	wire matrix**	120 cps	6	--	--	--	--	--	--	X	X	X	--
3773	1	X	wire matrix**	40 cps*	6	X***	--	--	--	--	--	--	--	--	--
	P1	X	wire matrix**	40 cps*	6	X***	--	A	--	--	--	--	--	--	--
	2	X	wire matrix**	80 cps	6	X***	--	--	--	--	--	--	--	--	--
	P2	X	wire matrix**	80 cps	6	X***	--	A	--	--	--	--	--	--	--
	3	X	wire matrix**	120 cps	6	X***	--	--	--	--	--	--	--	--	--
P3	X	wire matrix**	120 cps	6	X***	--	A	--	--	--	--	--	--	--	
3774	1	X	wire matrix**	80 cps	6	--	X***	--	--	X	--	X	X	X	X
	P1	X	wire matrix**	80 cps	6	X****	X***	ABC	X	X	--	X	X	X	X
	2	X	wire matrix**	120 cps	6	--	X***	--	--	X	--	X	X	X	X
	P2	X	wire matrix**	120 cps	6	X****	X***	ABC	X	X	--	X	X	X	X
3775	1	X	print belt	120 lpm	6 or 8	--	X***	--	--	X	--	X	X	X	--
	P1	X	print belt	120 lpm	6	X****	X***	ABC	X	X	--	X	X	X	--
3776	1	X	print belt	300 lpm	6 or 8	--	X***	--	--	X	--	X	X	X	--
	2	X	print belt	400 lpm	6 or 8	--	X***	--	--	X	--	X	X	X	--
3777	1	--	train	1000 lpm	6 or 8	--	X***	--	--	X	X	--	--	--	--

**Symbols:**

- X Yes
- No
- \* Rated
- \*\* Bidirectional printing
- \*\*\* Removable
- \*\*\*\* Nonremovable
- A Data check; forms control; logical, arithmetic, format, and edit operations
- B Interrupt offline program, to receive unsolicited message from CPU
- C Address stop, to assist in 3770 program debugging

Figure 2-28. Comparison of Characteristics of 3770 Terminals by Model

**3790 Communication System**

The IBM 3790 Communication System (Figure 2-29) is an operator-oriented remote system that consists of an IBM 3791 Controller and its attached operator stations and auxiliary control units. The operator stations can be keyboard-printers, keyboard-displays, or a mixture of these devices.

Multiple 3790 systems can form a communication network that links remote 3790 systems with the central system. A 3790 communication network consists of one or more 3790 Communication Systems, communication facilities, and the IBM processor.

Components of the 3790 system include:

- 3791 Controller Models 1A, 1B, 2A, and 2B
- 3792 Auxiliary Control Unit
- 2741 Communication Terminal
- 3277 Display Station Models 1 and 2
- 3284 Printer Models 2 and 2
- 3286 Printer Models 1 and 2
- 3288 Line Printer Model 2
- 3760 Dual Key Entry Station Models 1 and 2
- 3793 Keyboard-Printer

The IBM 3791 Controller, with the local channel attachment, can be attached directly to an IBM byte multiplexer or block multiplexer channel. The 3791 also communicates over communication lines via an IBM 3704 or 3705 Communications Controller with the IBM processor, using systems network architecture (SNA). Functions performed by the 3790 system are specified by

programs that are sent to the 3791 Controller from the IBM processor. These programs allow the 3790 system to operate without supervision from, or interaction with, the IBM processor, except when data or programs are being exchanged between systems.

The controller contains:

- Control storage for supporting features, functions, and operator stations
- Diskette storage for packed transmission data and for backup of application data sets
- Disk storage for 3790 programs, transaction records, and application data sets; depending on the model, the 3791 can have up to 26.9 million bytes of storage

Communication with the IBM processor is by nonswitched or switched communication facilities. For switched lines, automatic calling and answering are supported at the 3704 or 3705 Communications Controller; manual dial and auto-answer are supported at the 3791. A 1200-bps integrated modem is available, or an external 1200- or 2400-bps modem may be attached.

The IBM 3792 Auxiliary Control Unit, which may be located up to 2,000 feet from the 3791 Controller, allows for additional operator stations in the system (some of which can be remote from the 3790 site) and provides:

- The capability for attaching up to four 3793 Keyboard-Printer
- A line printer as a special feature



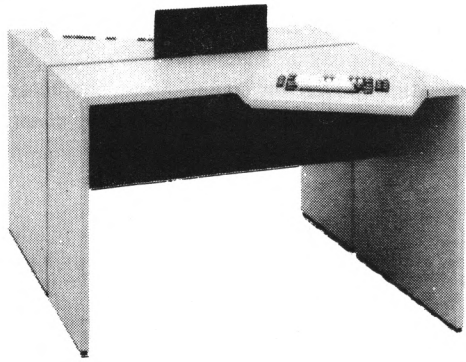

3760

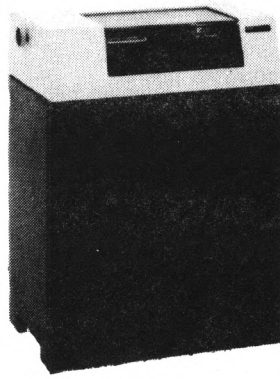

3284-1, -2  
3286-1, -2

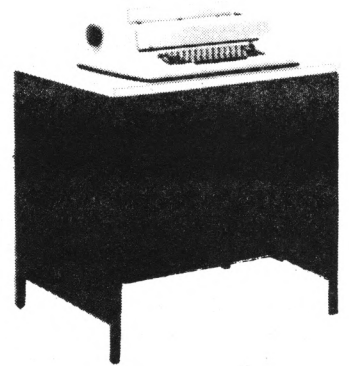

2741

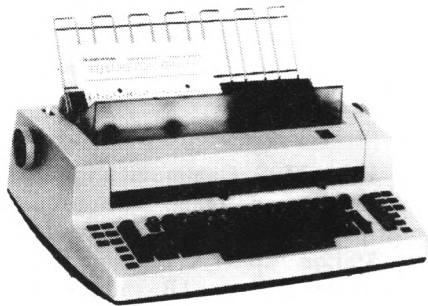

3793

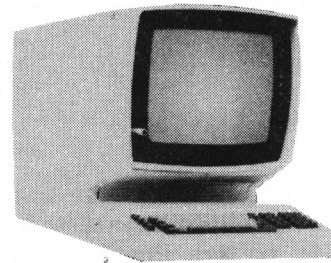

3277-2

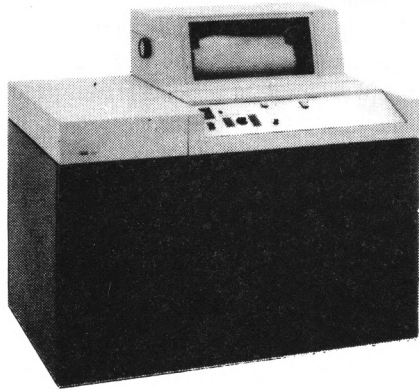

3791-1

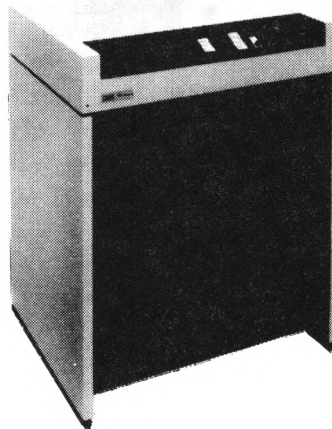

3792

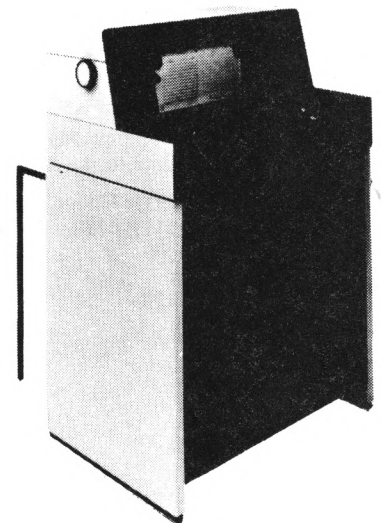

3288-2

Figure 2-29. Components of IBM 3790 Communication System and Attachable I/O Devices (Design Models)

- Special features for communicating with 2741 Communication Terminals
- A security keylock special feature that controls power to the 3792

The **IBM 3793 Keyboard-Printer** is a data entry operator station that can be attached to the 3791 or to the 3792 to provide printed output. The 3793 has a friction-feed platen, with a pinfeed platen available as a special feature. A maximum print line has 130 positions at 10 characters per inch; line spacing is 6 lines per inch.

The 3793 keyboard includes control keys, operator guidance indicators, and system indicators. Included on the normal office typewriter keyboard is a 10-key configuration of dual-function keys that can be used for entering numeric data. A special feature provides a power-line keylock for security.

The **IBM 3277 Display Station** can be attached to the 3791. The 3277 can display on its CRT screen up to 480 characters in 12 lines of 40 characters each (Model 1), or up to 1,920 characters in 24 lines of 80 characters each (Model 2). The last line on either model is reserved for controller use. Basic features of both models include:

- A 63-character set
- Editing features
- Dual brightness control
- Protection of data

The **Line Printer**, which is available as a special feature on the 3791 or 3792, prints continuous forms with line spacing of six lines per inch. Printing characteristics of the versions available are:

Available on	Print Positions	Speed (Lines per Minute)	Characters in Set
3791, 3792	80* or 132*	155	48
	80* or 132**	120	64
	80* or 132**	80	96
3791	132***	410	48
	132***	300	64
	132***	230	96

Maximum line length (print positions) must match on 3791 and 3792 controllers attached to the same system.

\* Feature 4710 (3791), 4712 (3792)

\*\* Feature 4711 (3791), 4713 (3792)

\*\*\* Feature 4715

**IBM 3284 Printer Models 1 and 2, IBM 3286 Printer Models 1 and 2, and IBM 3288 Line Printer Model 2** can be attached to the 3791 to provide hard-copy output at six lines per inch on continuous fanfold paper. Some characteristics of these printers are compared in the following chart:

Model	Printer Type	Print Speed	Print Positions***
3284	1 Wire Matrix	40 cps*	120, 126, or 132
	2 Wire Matrix	40 cps*	120, 126, or 132
3286	1 Wire Matrix	66 cps*	120, 126, or 132
	2 Wire Matrix	66 cps*	120, 126, or 132
3288	2 Line	120 lpm**	132

\* Rated

\*\* Maximum

\*\*\* Specify

The **IBM 3790 Communication System/Data Entry Configuration**, designed for production keying of transcriptive data, consists of the IBM 3760 Dual Key Entry Station Model 1 or Models 1 and 2; the 3791 Controller Model 1A or 1B; and the host IBM processor.

Each model of the 3760 provides two key-entry operator positions with keyboard and display area. Model 1 contains logic and storage, to perform control and display functions and to perform data editing and checking. Model 2 can be attached to Model 1 and is an expansion unit only, without the logic and control function. Another Model 2 can be attached to the first Model 2 to form a six-station group. The 3791 supports up to twelve 3760 Dual Key Entry Stations with a maximum of eight 3791 connections.

The 3790 Communication System/Data Entry Configuration cannot be used with other 3790 configurations. However, the 80-position line printer can be used with the data entry configuration, except when data is being transmitted between the 3791 and the host IBM processor.

## Appendix A. Glossary and Abbreviations

(Refer to the *IBM Data Processing Glossary*, GC20-1699, for definition of those terms not included in this listing.)

*communications-start-stop*: One of three classifications of adapter used for connecting remote and local devices to the 2701 Data Adapter Unit.

*data acquisition and control*: The process of identifying, isolating, and gathering source data and providing the correct facility for its transmission.

*data link*: The communication lines, modems, and other communication equipment arranged for data, used in the transmission of information between two or more locations.

*duplex circuit*: A circuit that can carry data in two directions at the same time.

*ICA*: integrated communications adapter.

*local mode*: A mode of operation that allows a communication terminal to be used as a typewriter.

*parallel data adapter*: A classification of transmission adapter used with the 2701 in data acquisition and control. A circuit is provided for each bit in the code structure.

*remote (vs local)*: Physically separated but acting on or controlling, as a terminal operates in data communications. May have facility for operating in local mode completely independent of the main unit.

*RES*: remote entry services.

*SDLC*: synchronous data link control.

*SDS*: status display support.

*shared subchannel*: A division of a channel data path; one that can control several I/O devices through one unit.

*simultaneous home-loop operation*: Local operation between units of the same configuration.

*SNA*: systems network architecture.

*synchronous communications adapter*: A classification of transmission adapter used in connecting remote and local devices to the 2701 Data Adapter Unit.

*synchronous data link control (SDLC)*: A line discipline in data communications that includes comprehensive detection and recovery procedures, at the data link level, for transmission error that may be introduced by the communication lines.

*Systems Network Architecture (SNA)*: A flexible data communication network design that utilizes a single access method, a single network control program, and a single communication line control.

- access method 1-5
- American Standard Code for Information Interchange (ASCII) 1-4
- ASCII (American Standard Code for Information Interchange) 1-4
- asynchronous transmission in data communications 1-3
- audio response devices 2-1
- basic telecommunications access method (BTAM) 1-5
- binary synchronous communications (BSC) 1-4
- BSC (binary synchronous communications) 1-4
- BTAM (basic telecommunications access method) 1-5
- codes 1-3
- communication control (devices and lines) 1-2
- data acquisition 1-6
- data terminal devices 2-2
- data transmission multiplexers 2-7
- demodulation 1-2
- diskette (IBM) 2-24
- display devices 2-12
- duplex (communication lines in data communications) 1-2
- EBCDIC (Extended Binary-Coded Decimal Interchange Code) 1-4
- Extended Binary-Coded Decimal Interchange Code 1-4
- half-duplex communication lines in data communications 1-2
- host processor 1-2
- leased communication lines 1-3
- line adapters 1-2
- line adapter unit 2-11
- modems in data communications 1-2
- modulation 1-2
- modulator/demodulators (modems) 1-2, 2-11
- multipoint communications lines 1-2
- NCP/VS (network control program/virtual storage) 1-5
- network control program/virtual storage (NCP/VS) 1-5
- network, in data communications 1-1
  - elements of 1-2
- private communication lines 1-3
- programming systems 1-5
- QTAM (queued telecommunications access method) 1-5
- queued telecommunications access method (QTAM) 1-5
- SNA (systems network architecture) 1-6
- switched communication lines 1-3
- synchronous transmission in data communications 1-4
- systems network architecture (SNA) 1-6
- Universal Product Code 2-23, 2-24
- virtual telecommunications access method (VTAM) 1-5
- VTAM (virtual telecommunications access method) 1-5
- 1001 Data Transmission Terminal 2-2
- 1030 Data Collection System 2-13
- 1050 Data Communication System 2-14
- 2701 Data Adapter Unit 2-7
- 2711 Line Adapter Unit 2-11
- 2740 Communications Terminal 2-2
- 2741 Communications Terminal 2-3
- 3270 Information Display System 2-15
- 3275 Display Station 2-12
- 3600 Finance Communication System 2-17
- 3650 Retail Store System 2-20
- 3660 Supermarket System 2-23
- 3704 Communications Controller 2-8
- 3705 Communications Controller 2-9
- 3735 Programmable Buffered Terminal 2-4
- 3740 Data Entry System 2-24
- 3767 Communication Terminal 2-5
- 3770 Data Communication System 2-26
- 3780 Data Communications Terminal 2-5
- 3781 Card Punch 2-5
- 3790 Communication System 2-28
- 3872 Modem 2-11
- 3874 Modem 2-11
- 3875 Modem 2-11
- 7770 Audio Response Unit 2-1

Order No. GA27-3185-0

This manual is part of a library that serves as a reference source for systems analysts, programmers, and operators of IBM systems. This form may be used to communicate your views about this publication. They will be sent to the author's department for whatever review and action, if any, is deemed appropriate. Comments may be written in your own language; use of English is not required.

IBM may use or distribute any of the information you supply in any way it believes appropriate without incurring any obligation whatever. You may, of course, continue to use the information you supply.

**Note:** *Copies of IBM publications are not stocked at the location to which this form is addressed. Please direct any requests for copies of publications, or for assistance in using your IBM system, to your IBM representative or to the IBM branch office serving your locality.*

Possible topics for comment are:

Clarity    Accuracy    Completeness    Organization    Coding    Retrieval    Legibility

If you wish a reply, give your name and mailing address:

---

---

---

Note: Staples can cause items with automated mail sorting equipment. Please use pressure-sensitive or other gummed tape to seal this form.

What is your occupation? \_\_\_\_\_

Number of latest Newsletter associated with this publication: \_\_\_\_\_

Thank you for your cooperation. No postage stamp necessary if mailed in the U.S.A. (Elsewhere, an IBM office or representative will be happy to forward your comments or you may mail directly to the address in the Edition Notice on the back of the front cover or title page.)

ADDITIONAL COMMENTS:

Cut or Fold Along Line

Please Do Not Staple

Fold and tape

Fold and tape

First Class  
Permit 40  
Armonk  
New York

**Business Reply Mail**

No postage stamp necessary if mailed in the U.S.A.

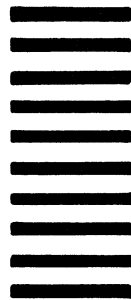

Postage will be paid by:

International Business Machines Corporation  
Dept. E02  
P.O. Box 12195  
Research Triangle Park  
North Carolina 27709

Fold and tape

Fold and tape

IBM Data Communication Device S (File No. S370-09) Printed in U.S.A. GA27-3185-0



International Business Machines Corporation  
Data Processing Division  
1133 Westchester Avenue, White Plains, N.Y. 10604

IBM World Trade Americas/Far East Corporation  
Town of Mount Pleasant, Route 9, North Tarrytown, N.Y., U.S.A. 10591

IBM World Trade Europe/Middle East/Africa Corporation  
360 Hamilton Avenue, White Plains, N.Y., U.S.A. 10601



International Business Machines Corporation  
Data Processing Division  
1133 Westchester Avenue, White Plains, N.Y. 10604

IBM World Trade Americas/Far East Corporation  
Town of Mount Pleasant, Route 9, North Tarrytown, N.Y., U.S.A. 10591

IBM World Trade Europe/Middle East/Africa Corporation  
360 Hamilton Avenue, White Plains, N.Y., U.S.A. 10601