

IBM

**IBM Displaywriter System
Printer Guide**

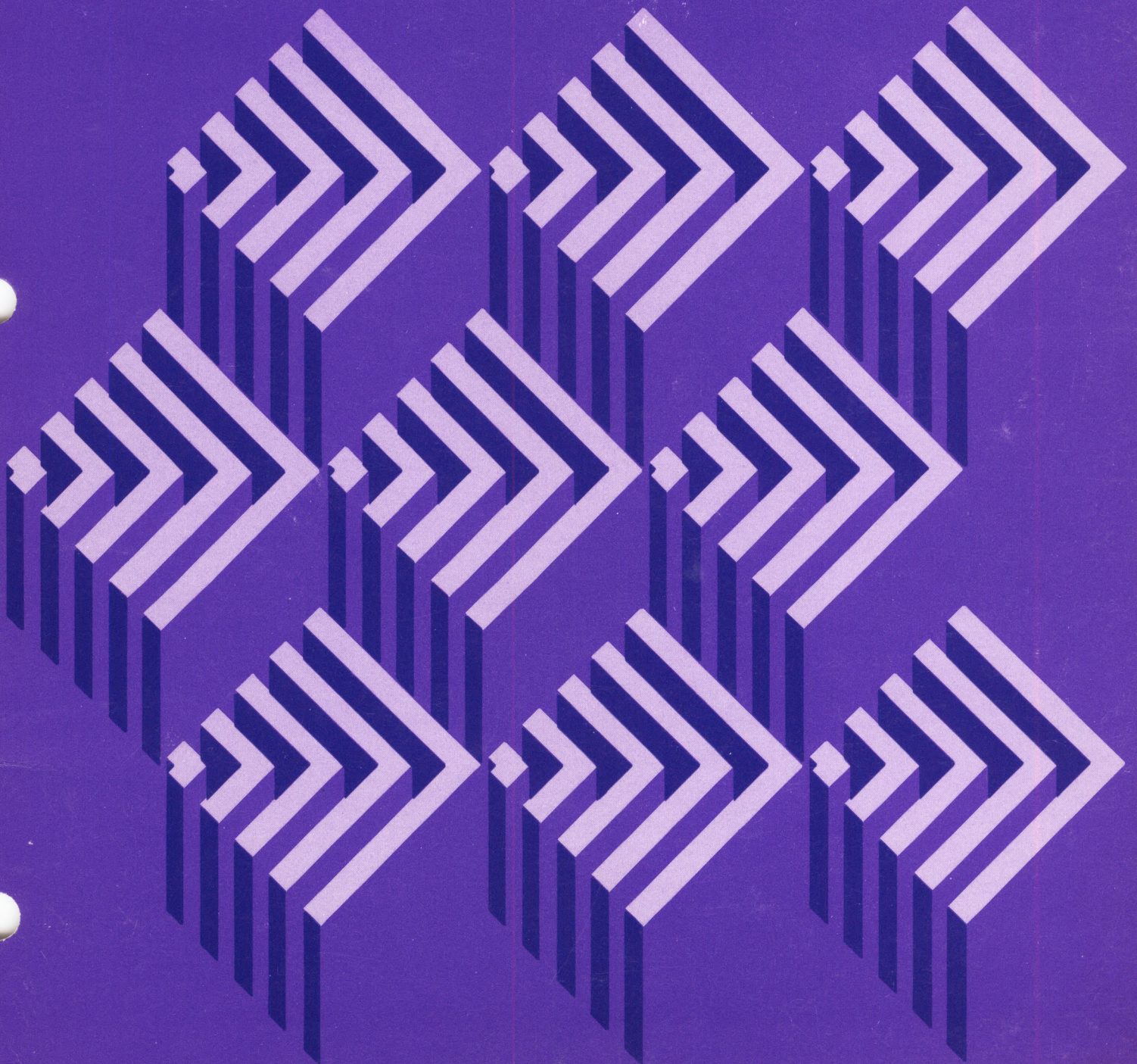

IBM Displaywriter System Printer Guide



PART 1. IBM 5215 PRINTER

Chapter 1. Features of the IBM 5215 Printer	3
Chapter 2. Changing Features	7
Chapter 3. Optional Features	13
Chapter 4. Maintaining the Printer	33

This page is intentionally left blank.

Fifth Edition (May 1983)

This major revision obsoletes S554-0861-3. Changes or additions to the text and illustrations are indicated by a vertical line to the left of the change.

This edition applies to all printer models of the IBM Displaywriter System, and to all subsequent releases and modifications until otherwise indicated in new editions or Technical Newsletters. Changes are made periodically to the information herein.

References in this publication to IBM products, programs, or services do not imply that IBM intends to make these available in all countries in which IBM operates. Any reference to an IBM program product in this publication is not intended to state or imply that only IBM's program product may be used. Any functionally equivalent program may be used instead.

Publications are not stocked at the address given below. Requests for IBM publications should be made to your IBM representative or to the IBM branch office serving your locality.

A form for readers' comments is provided at the back of this publication. If the form has been removed, comments may be addressed to IBM Corporation, Department 997, 11400 Burnet Road, Austin, Texas 78758. IBM may use or distribute whatever information you supply in any way it believes appropriate without incurring any obligation to you.

CHAPTER 1. FEATURES OF THE IBM 5215 PRINTER

The IBM 5215 Printer is the part of the IBM Displaywriter System with which you produce printed output. After creating documents at the work station and storing them on diskette, you can at any time print them at the printer.

This book describes only the physical features of the printer. The steps you follow to print a document are listed in "Topic 4. Printing" in the IBM Displaywriter System Operator Training Book 1 -- Basic Topics.

EXTERNAL PRINTER FEATURES

In order to maintain the printer and change features when necessary, you must be familiar with the printer features. The following two pages contain an illustration of the IBM 5215 Printer and descriptions of its features. The features you will need to be familiar with are numbered in the illustration, and each numbered item is explained on the facing page.

Locate each feature on the printer illustration and read its description.

PREFACE

This manual describes the IBM 5215 Printer, the IBM 5218 Printwheel Printer, and the IBM 5228 Printwheel Printer for the IBM Displaywriter System. It points out the features on the printers and explains such tasks as changing the paper, ribbons, platens, and printwheels and how to respond to printer lights and use the paper handling devices.

AUDIENCE

This publication is intended for the IBM Displaywriter System operators who use the IBM 5215 Printer, the IBM 5218 Printerwheel Printer, or the IBM 5228 Printwheel Printer. No prior knowledge or experience is required.

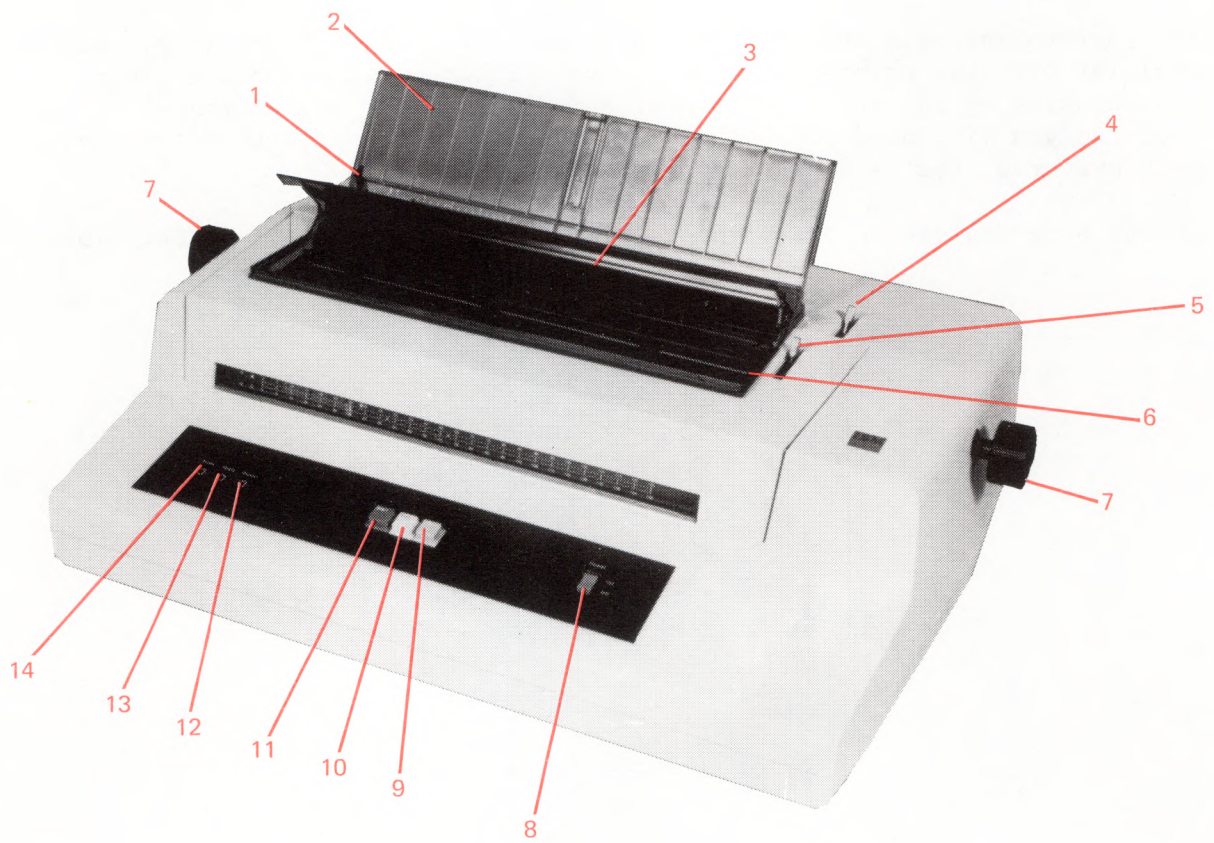

CONTENTS

 Part 1. IBM 5215 Printer	1
 Chapter 1. Features of the IBM 5215 Printer	3
External Printer Features	3
Element And Ribbon Cartridge	6
Optional Features	6
Chapter 2. Changing Features	7
To Insert Paper	7
To Remove Paper	8
Changing The Ribbon	9
To Remove a Ribbon	9
To Install a New Ribbon	9
To Install a Used Ribbon	10
Element Description	11
To Remove an Element	12
To Put On an Element	12
Chapter 3. Optional Features	13
Pin-Feed Platen	13
To Remove the Platen and	13
Install the Pin-Feed Platen	13
To Attach the Paper Separator	21
To Attach the Paper Guide Rollers	23
To Insert Continuous Paper Into The Pin-Feed Platen	24
To Position The Paper Stacker	29
The Roll Paper Holder	30
Chapter 4. Maintaining the Printer	33
Cleaning The Printer Cover	33
Cleaning The Cardholder and Margin Scale	33
Cleaning The Element	33
Serial Number	33
Part 2. IBM 5218 and IBM 5228 Printwheel Printers	35
Chapter 5. Features of the IBM 5218 and IBM 5228 Printwheel Printer	37
How To Use This Section Of The Printer Guide	37
Chapter 6. Printwheel and Ribbon Cartridge	41
Chapter 7. Changing the Ribbon	43
To Remove A Ribbon	43
To Install A New Ribbon	44
Chapter 8. Changing the Printwheel	47
Printwheel Descriptions	47
To Remove A Printwheel Cartridge	49
To Insert A Printwheel Cartridge	51

1. Paper Guide	Aligns the left edge of the paper into the printer. The paper guide slides across the paper centering scale. When aligned with the bold vertical line on the paper centering scale, the left edge of the paper corresponds to zero (0) on the margin scale.
2. Paper Support	Gives vertical support for cut sheet paper in the printer.
3. Sound Shield	Reduces sound and protects the platen and ribbon area.
4. Paper Release Lever	Releases tension from the platen for easy paper insertion and removal.
5. Paper Bail Lever	Pulls the paper bail forward for inserting paper.
6. Paper Bail	Holds the paper tightly against the platen. The paper bail automatically goes back against the paper when printing begins.
7. Platen Knobs	Assist in rolling paper in and out of the printer. When the left knob is pressed in, it will give the platen a free roll in either direction.
8. On/Off Switch	Supplies power to the printer. Press to the "On" position to turn on and to the "Off" position to turn off.
9. Cancel Button (Blue)	Signals the work station to cancel the job in print.
10. Stop Button (Yellow)	Signals the printer to stop printing. To resume printing, press "Start."
11. Start Button (Green)	Begins the printing process. Press to start printing.
12. Ribbon Light (Yellow)	Goes on when the ribbon needs replacing. The printer completes the line in print, carrier returns, and stops in the center of the page. Change Printer Ribbon prompts at the work station. After changing the ribbon, press "Start" to continue printing.
13. Ready Light (Green)	Goes on when the printer is ready to begin printing. The light goes out when the ribbon light flashes on.
14. Power Light (Red)	Goes on when the power to the printer is turned on.

Chapter 9. Inserting Cut Sheet Paper 53

- Inserting Cut Sheet Paper into a Printer without a Paper Support Table 53
- Paper Support Table Installation 55
- Inserting Paper with a Paper Support Table Attached 55
- To Remove Cut Sheet Paper From The Printer 57

Chapter 10. IBM Tractor Feed 59

- Installing the IBM Tractor Feed 59
- Loading Paper Into the IBM Tractor Feed 65
- Unloading Paper from the IBM Tractor Feed 74
- Loading Paper and Envelopes Manually with the IBM Tractor Feed Attached 75
- Removing the IBM Tractor Feed from the Printer 77
- Tractor Feed Loading with 5 and 6 Part Forms 79

Chapter 11. IBM Sheet-Feed Paper Handler 89

- Installation Of The IBM Sheet-Feed Paper Handler 89
- Loading Paper Into The IBM Sheet-Feed Paper Handler 92
- Inserting Cut Sheet Paper or Envelopes Manually with the IBM Sheet-Feed Paper Handler Attached 98
- Clearing Paper Misfeeds From The Sheet-Feed Paper Handler 100
 - Output Paper Path Jam 100
 - Input Paper Path Jam 101
- Removing The Sheet-Feed Paper Handler 102

Chapter 12. IBM Front Exit Sheet Feed 105

- Installation of the IBM Front Exit Sheet Feed 105
- Positioning The Output Tray To The Raised Position 108
- Loading Paper or Envelopes Manually with the Front Exit Sheet Feed Attached 109
- Loading Paper And Envelopes Into The IBM Front Exit Sheet Feed 113
 - Loading Paper In The IBM Front Exit Sheet Feed 113
 - Loading Envelopes In The IBM Front Exit Sheet Feed 118
- Adjusting The Paper Output Tray 120
- Clearing Misfeeds From The IBM Front Exit Sheet Feed 121
 - Output Path 121
 - Input Paper Path 122
- Removing the IBM Front Exit Sheet Feed 124

Chapter 13. Supplies 127

- Supplies Ordering 127
- Printwheel Cartridges 127
- Ribbons 127
- Cables 127
- Extra Paper Trays 127
- Paper Stand 128
- Paper Support Table 128
- Adapter Cables 128

Chapter 14. Care and Cleaning 129

- Cleaning 129

Appendix A. IBM 5215 Printer Element Descriptions 131

Appendix B. IBM 5215 Printer Message Descriptions 137

ELEMENT AND RIBBON CARTRIDGE

Lift the printer cover to locate the features shown in the illustration below.

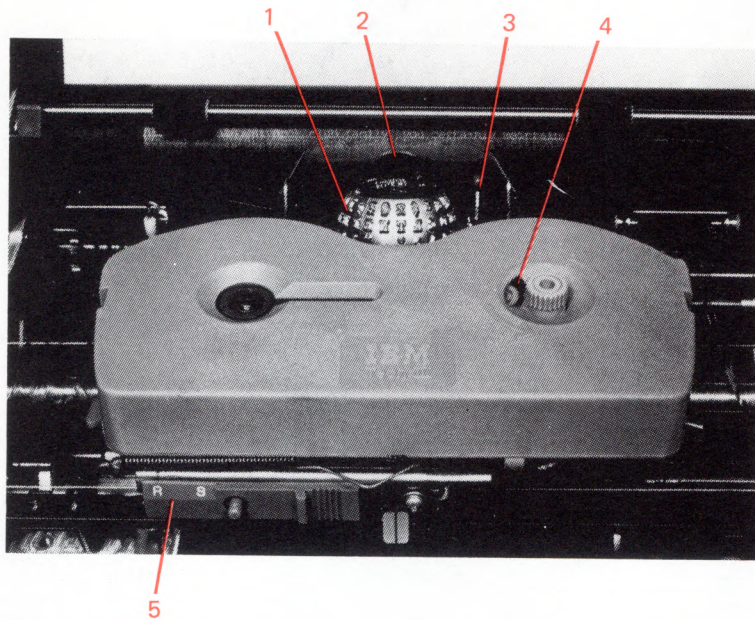

1. **Element** -- Contains the characters used to print a document.
2. **Cardholder** -- Secures small cards and short sheets of paper tightly against the platen.
3. **Impression Control** -- Adjusts the striking force of the element. Set the control on "3" for routine jobs. Move to a higher number for stencils and multiple copies.
4. **Ribbon Cartridge** -- contains the printer ribbon.
5. **Ribbon/Stencil Control** -- Adjusts the ribbon for printing stencils. Set the control on "S" for printing stencils. Slide the lever to "R" for normal printing.

OPTIONAL FEATURES

Optional features for the IBM 5215 Printer are described in Chapter 3. These optional features are needed only if continuous forms are used.

Appendix C. IBM 5215 Printer Specifications	143
Type Styles	143
Paper Specifications	143
Paper Types	143
Paper Sizes	143
Recommended Environment For The Pin-Feed Platen	144
Appendix D. IBM 5218/IBM 5228 Printwheel Printer Type Styles/Printwheels	145
Appendix E. IBM 5218/IBM 5228 Printwheel Printer Printwheel Descriptions	149
Appendix F. IBM 5218/IBM 5228 Printwheel Printer Message Descriptions	151
Appendix G. IBM 5218/IBM 5228 Printwheel Printer Paper Specifications	153
Tractor Feed Paper Types	153
Tractor Feed Paper Sizes	153
Sheet-Feed Recommended Paper Composition	153
Sheet-Feed Paper Weights	154
Sheet Feed Paper Sizes	154
Sheet-Feed Paper Limitations	155
Sheet-Feed Paper Conditions	155
Paper Storage	155
Front Exit Sheet Feed Recommended Envelope Weights	156
Front Exit Sheet Feed Envelope Sizes	156
Front Exit Sheet Envelope Limitations	156
Front Exit Sheet Envelope Conditions	156
Envelope Storage	156
Paper Specification For Manual Insertion	156

CHAPTER 2. CHANGING FEATURES

You will sometimes need to perform several mechanical tasks as you use the printer. You will need to change paper, change the ribbon, and change the element. These tasks are described in this chapter.

TO INSERT PAPER

The system tells you when to insert paper in the printer when the Load Paper in Printer message shows on the display. To insert paper in the printer, use the illustration below and the steps that follow it.

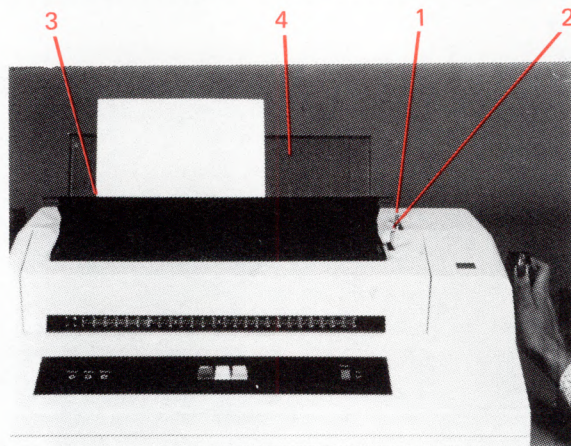

- Pull the paper bail (2) away from the platen.
- Align the left edge of the paper guide (3) with the bold vertical line on the paper support (4).
- Place the paper into the printer until it is behind the cardholder and the top edge is aligned with the bottom red line on the cardholder.
- Press Start. The system indexes the paper up, the paper bail closes, and printing begins.

TO REMOVE PAPER

To remove paper from the printer, follow these steps:

- Pull the paper release lever (1) forward.
- Pull the paper out.

Under normal circumstances, as each page completes printing, the system automatically indexes the paper to the end of the page.

CHANGING THE RIBBON

When the Change Printer ribbon message shows on the display, the yellow ribbon light goes on at the printer. Use the following illustration as a guide to remove or install a ribbon.

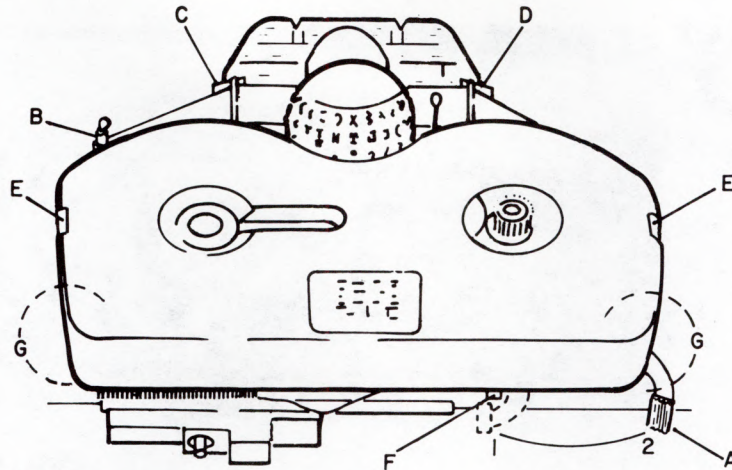

To Remove a Ribbon

To remove a ribbon, follow these steps:

- Open the cover.
- Pull the ribbon load lever (A) to the left until it clicks against the stop (F).
- With both hands, hold the ribbon cartridge at the front corners (G), and lift straight up.
- Unthread the ribbon from the ribbon guides (C and D).

To Install a New Ribbon

To install a new ribbon, follow these steps:

- Pull the load lever (A) to the left until it clicks against the stop (F).
- Put the leader portion of the ribbon over the outside of the guidepost (B) and the ribbon guides (C and D).
- Place the ribbon cartridge so it fits between the spring clips (E).
- Push both ends of the cartridge down firmly.
- Thread the leader portion of the ribbon through the ribbon guides (C and D).
- Turn the knob on the cartridge in the direction of the arrow until the leader is past the ribbon guide (C).

- Move the ribbon load lever (A) to the far right until it clicks.
- Close the cover. The ribbon light will go off.

To Install a Used Ribbon

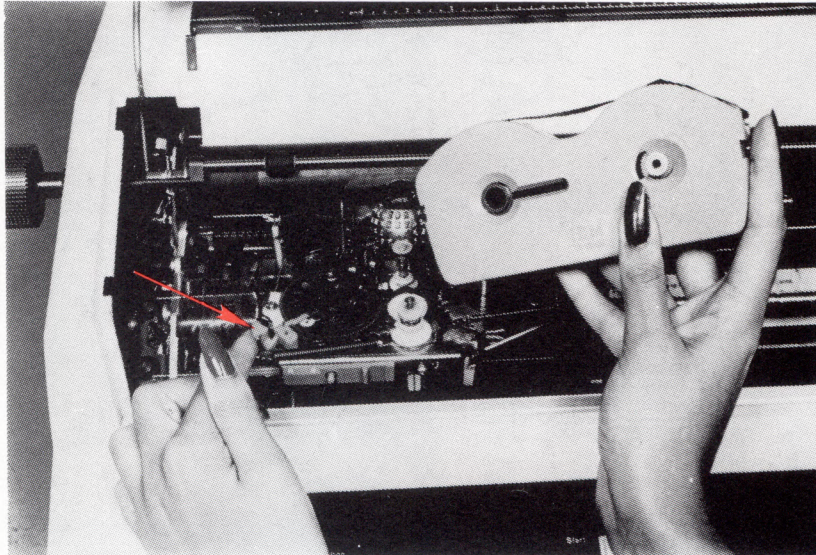

To install a used ribbon, raise the end-of-ribbon lever (see arrow in the illustration above) and hold it up while putting the ribbon cartridge in place. Then follow the steps for installing a new ribbon.

ELEMENT DESCRIPTION

Look at the illustration below and read the description of the parts of an element which follow.

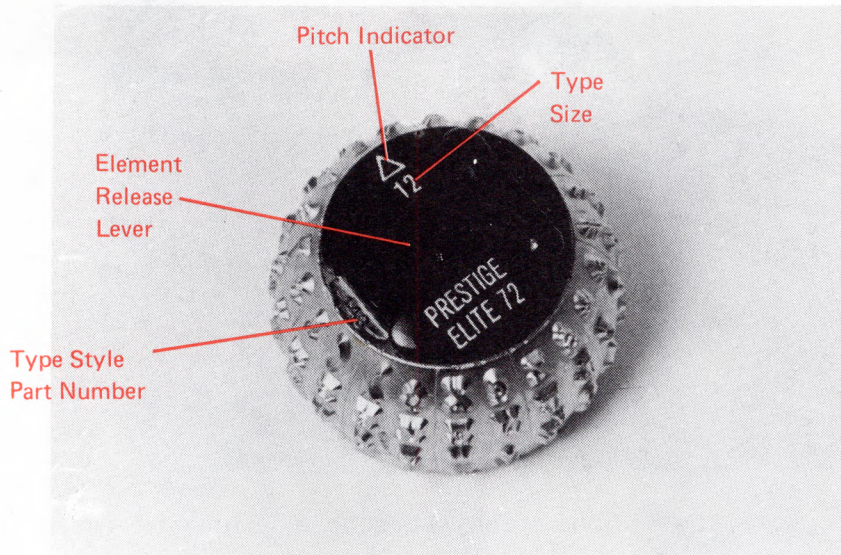

- **Pitch Indicator and Type Size**

△ = 12 pitch (12 character per inch)

▲ = 10 pitch (10 characters per inch)

- **Element Release Lever** -- Used to insert and remove the element.
- **Type Style Name** -- The name assigned to a particular type face.
- **Type Style Part Number** -- The number assigned to each available type style.

To Remove an Element

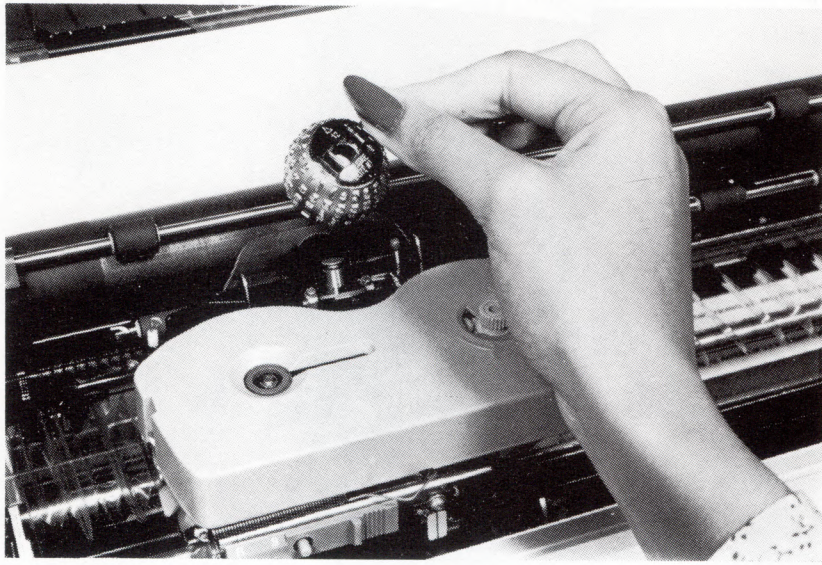

To remove an element, use the illustration above as a guide and follow these steps:

- Lift the element release lever to the open position. When it is open, you will hear a click.
- Hold the lever, and lift the element straight off the post.

To Put On an Element

To put on an element, follow these steps:

- Lift the element lever to the open position.
- Place the element on the post with the triangle pointing toward the platen.
- Rotate the element until it fits into a groove and will not rotate.
- Once the element is in place, close the lever.

CHAPTER 3. OPTIONAL FEATURES

If continuous-form paper or continuous-form envelopes are used with the IBM 5215 Printer, a Pin-Feed Platen is installed to handle the continuous forms.

PIN-FEED PLATEN

If roll paper is used a Roll Paper Holder is installed. The Roll Paper Holder holds paper on to the printer. Installation of the Pin-Fed Platen and Roll Paper Holder are described in this chapter.

Before installing the Pin-Feed Platen, the platen used for regular printing must be removed from the printer.

To Remove the Platen and

Install the Pin-Feed Platen

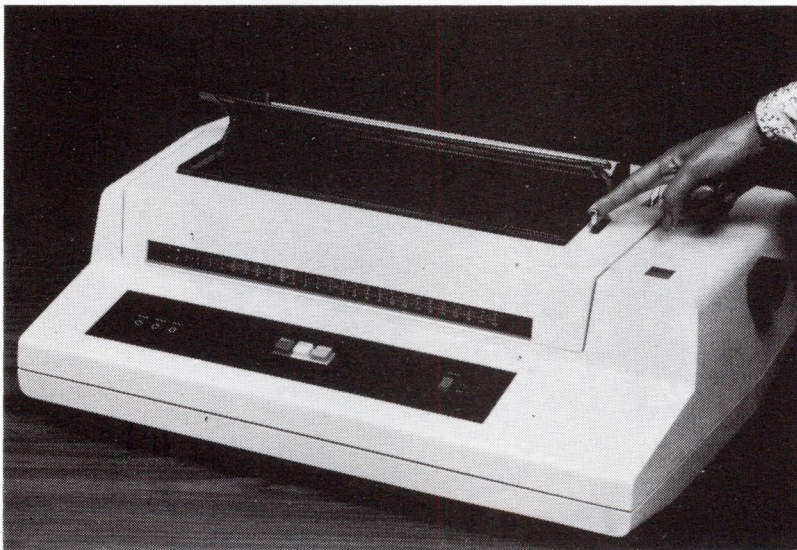

Turn the printer power off.

Pull the paper bail forward.

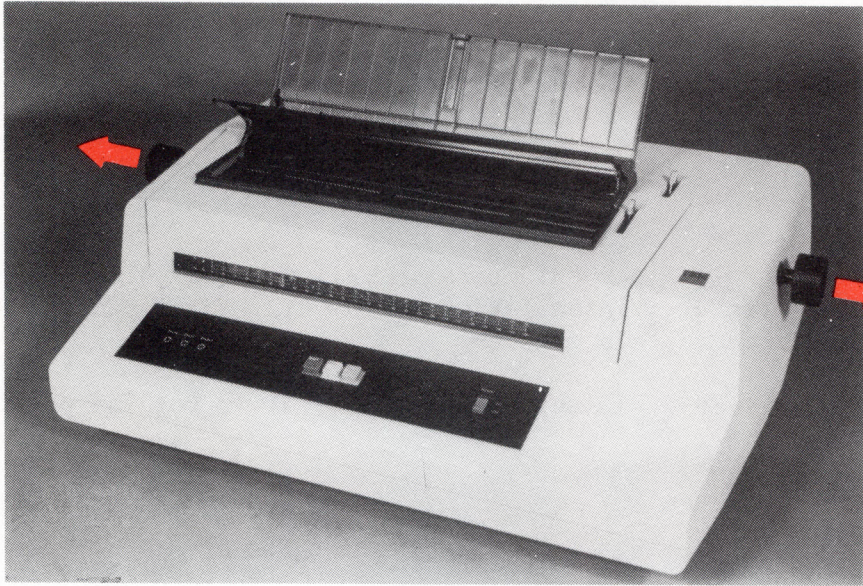

Pull the left and right platen knobs away from the printer.

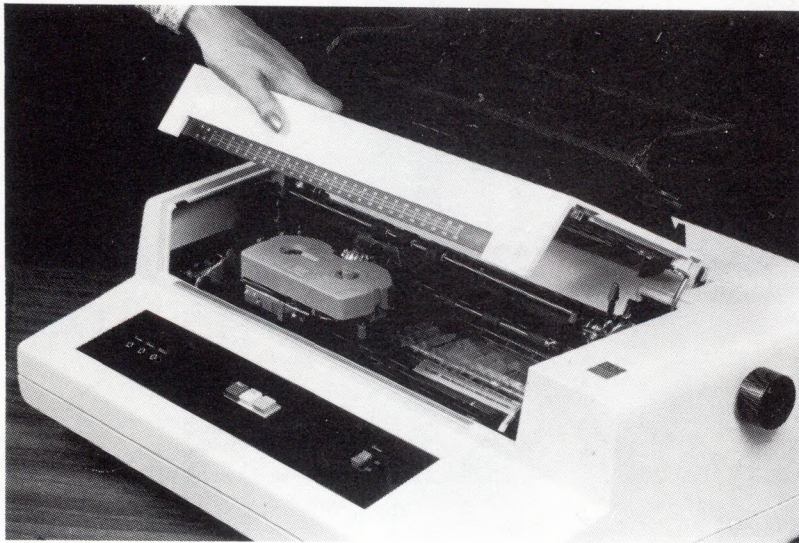

Raise the printer cover.

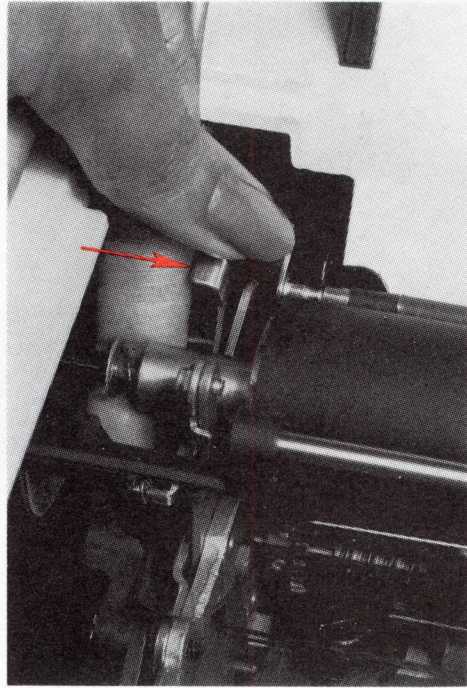

Press the two platen release levers down.

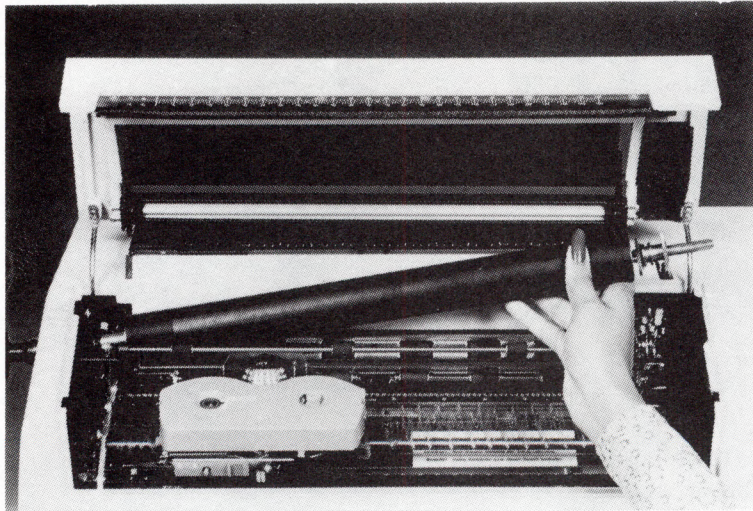

Lift the platen out of the printer.

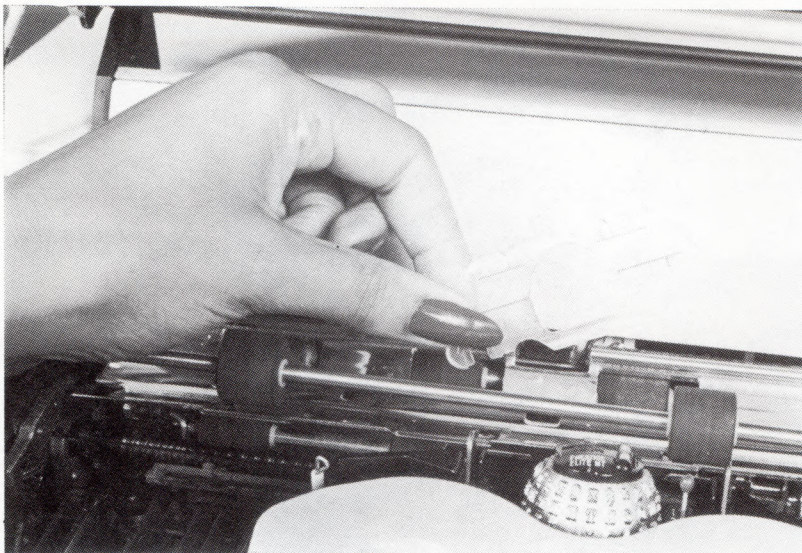

Remove the cardholder with the enclosed top that is used for normal printing.

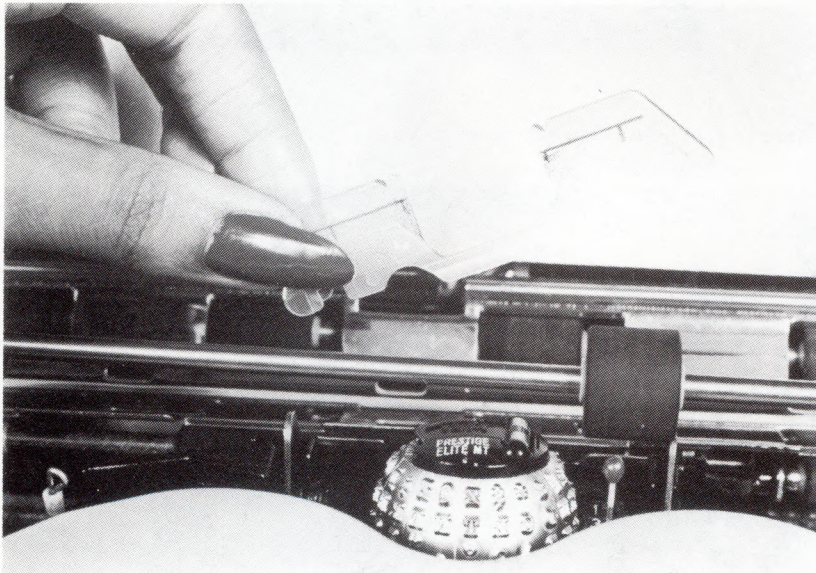

Snap the pin-feed cardholder onto the printer. Make sure the smooth side of the cardholder is against the platen.

Close the printer cover.

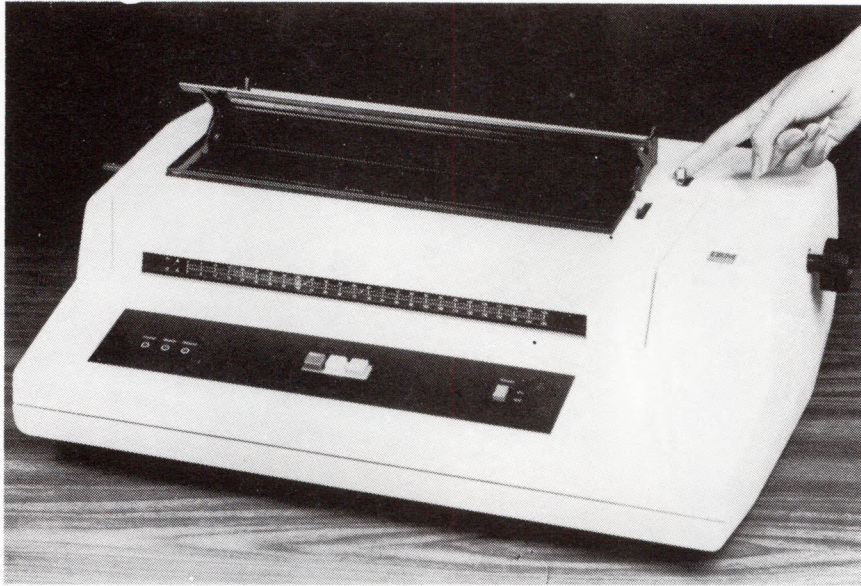

Pull the paper release lever forward.

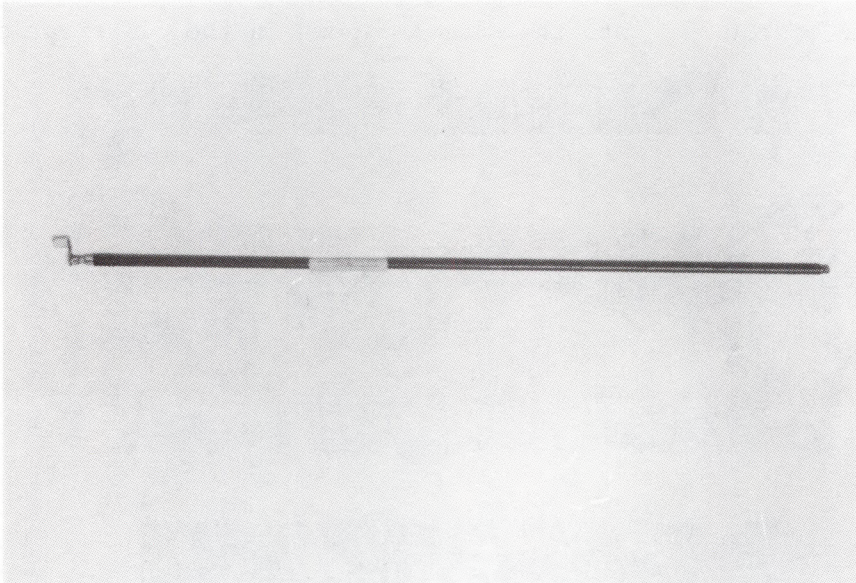

Open the printer cover.

Locate the Paper Bar, as shown in the above photograph. The Paper Bar will be used when inserting continuous paper into the printer (see page 26).

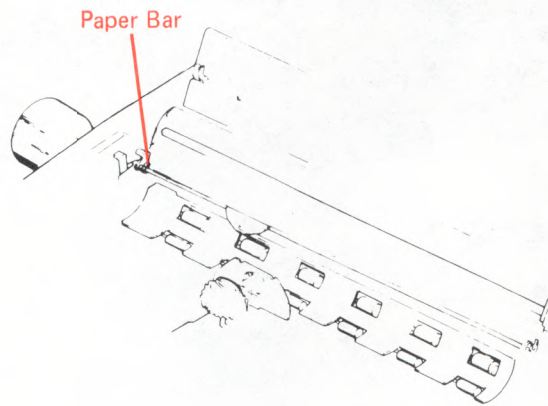

Insert the Paper Bar into the printer so that the handle is on the left.

Slide the right (square) end of the Paper Bar into the right slot.

Connect the left end of the bar into the slot as shown in the illustration above.

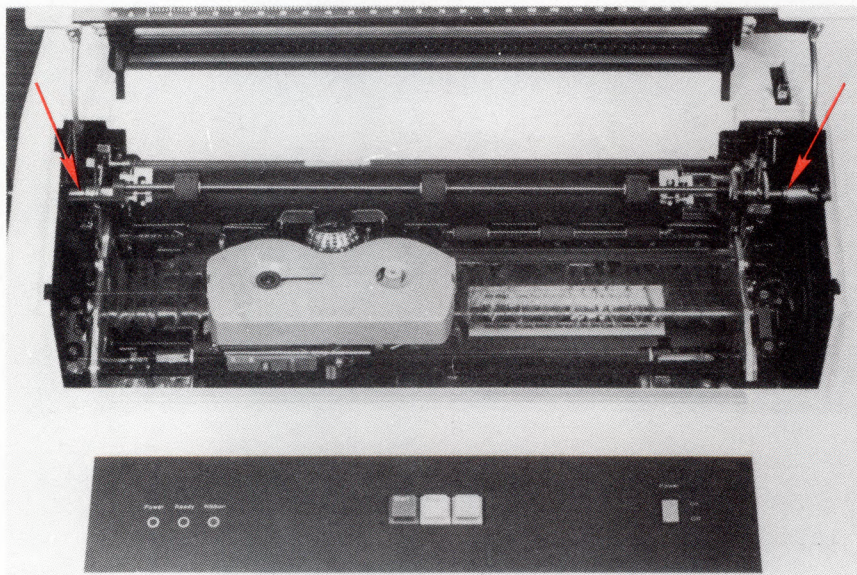

Lay the Pin-Feed Platen into the silver platen holder. Make sure the square end of the platen is on the left and the round end is on the right.

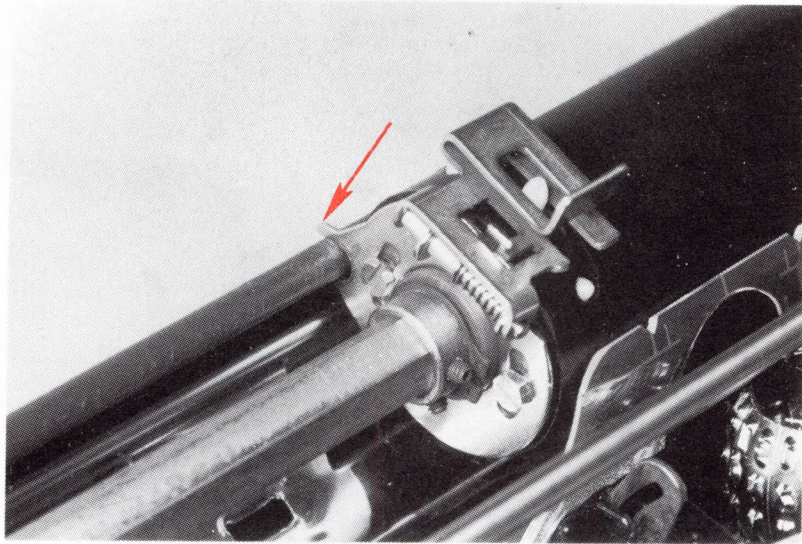

Locate forks on each end of the platen and connect them to the Paper Bar as shown in the photograph.

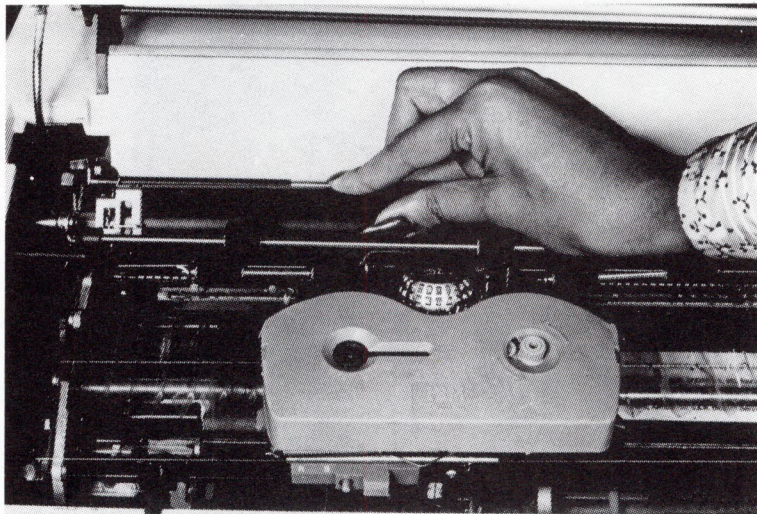

Press down on the platen to snap it into place.

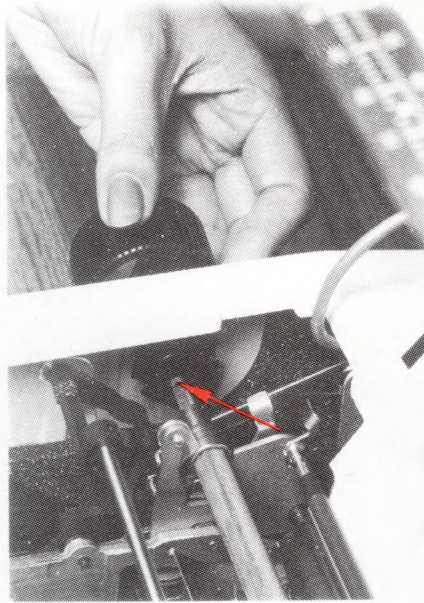

Close the left platen knob by aligning the square hole with the square end of the platen; press the knob in.

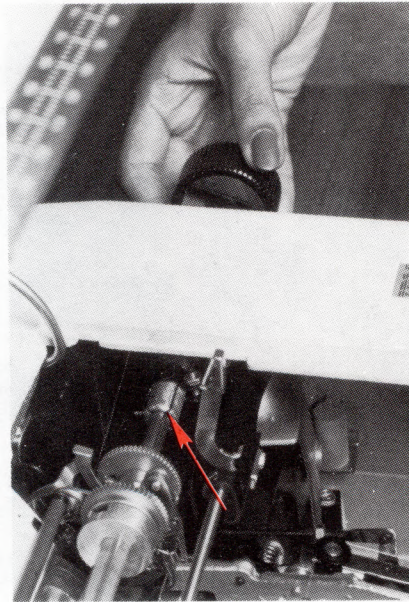

Align the right end of the platen knob with the round hole in the knob; press to close.

Close the paper bail.

Close the printer cover.

To Attach the Paper Separator

After installing the Pin-Feed Platen, the Paper Separator must be attached to the printer.

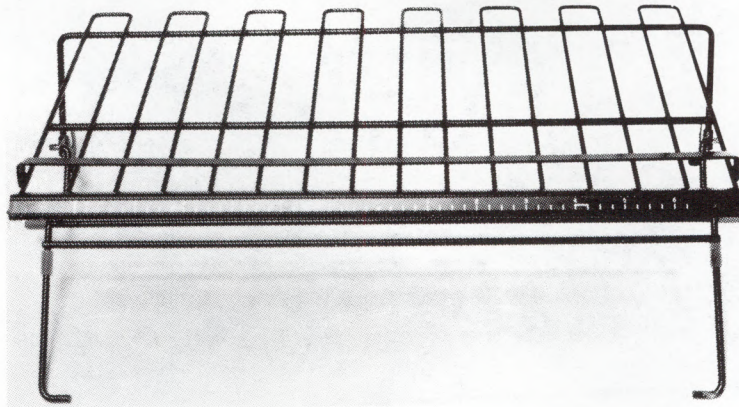

Locate the Paper Separator and place on the printer.

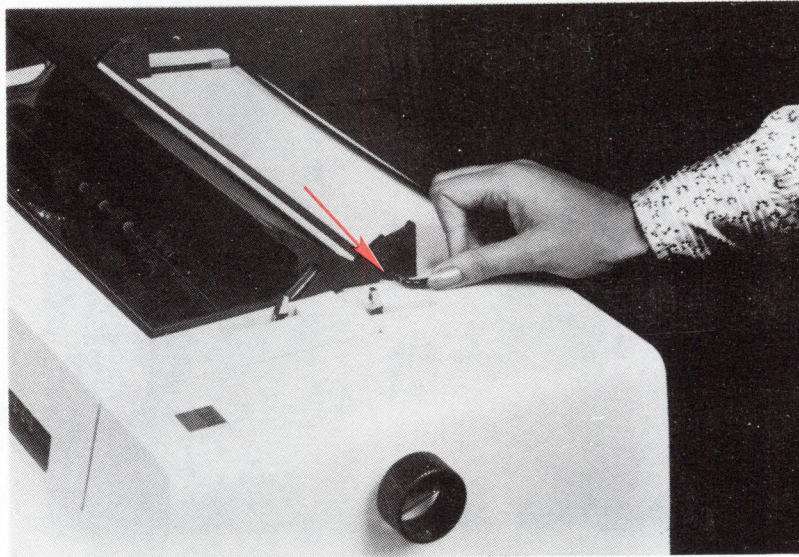

Insert the wire brackets into the mounting holes on each side of the printer.

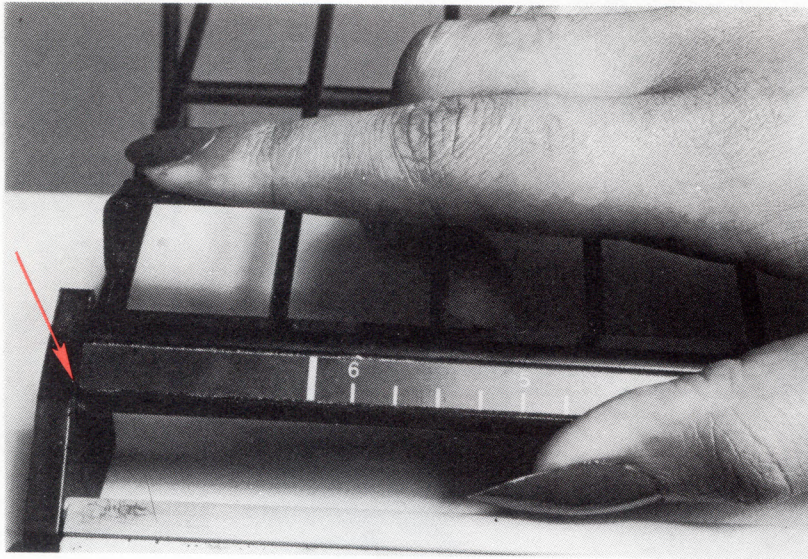

Insert the front brackets into the notches on each side of the printer.

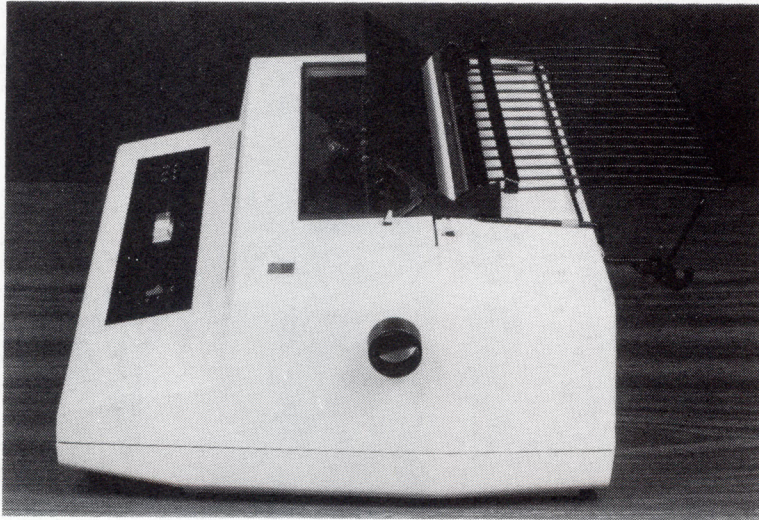

When the Paper Separator is installed, it should look like the photograph above.

To Attach the Paper Guide Rollers

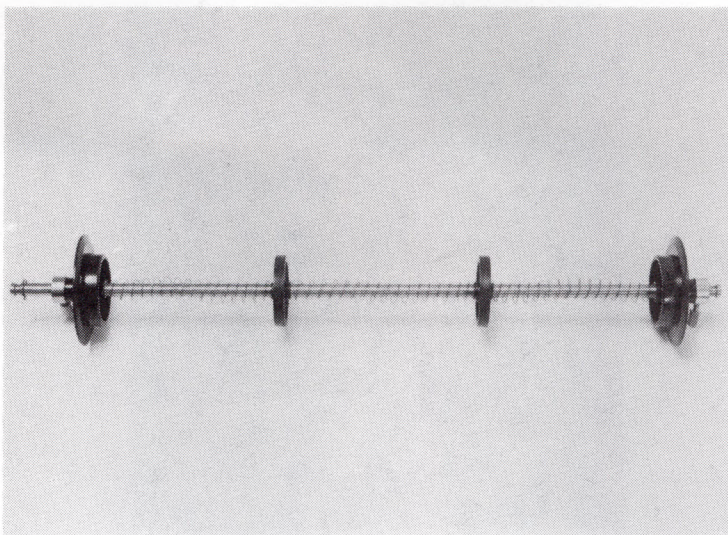

Locate the paper guide rollers, as shown in the above photograph.

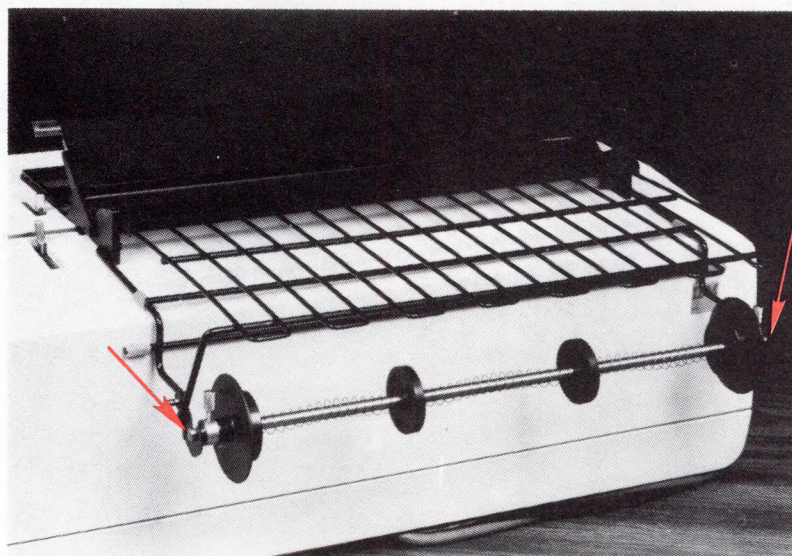

Connect the paper guide rollers into the hooks on the back of the Paper Separator.

TO INSERT CONTINUOUS PAPER INTO THE PIN-FEED PLATEN

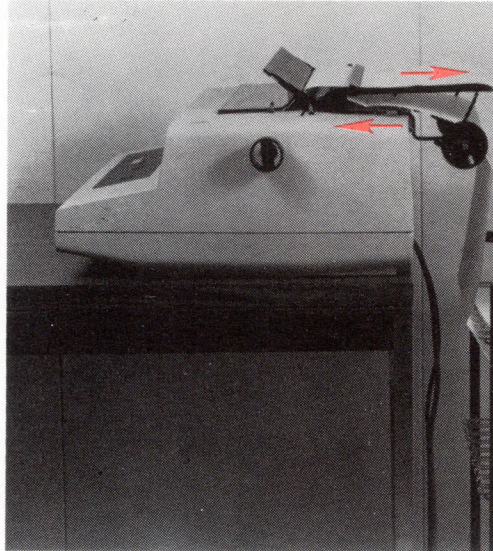

The paper path for continuous-form paper in the Pin-Feed Platen should follow the arrows in the above photograph.

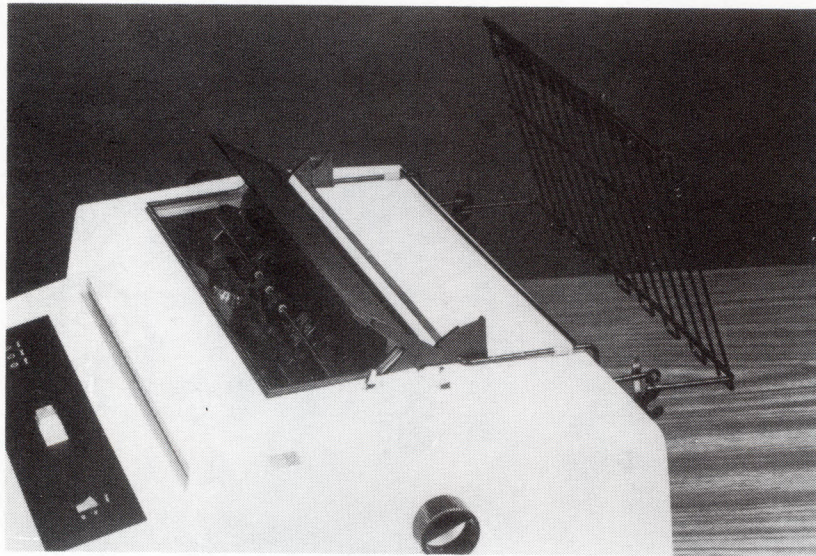

Lift the Paper Separator Gate.

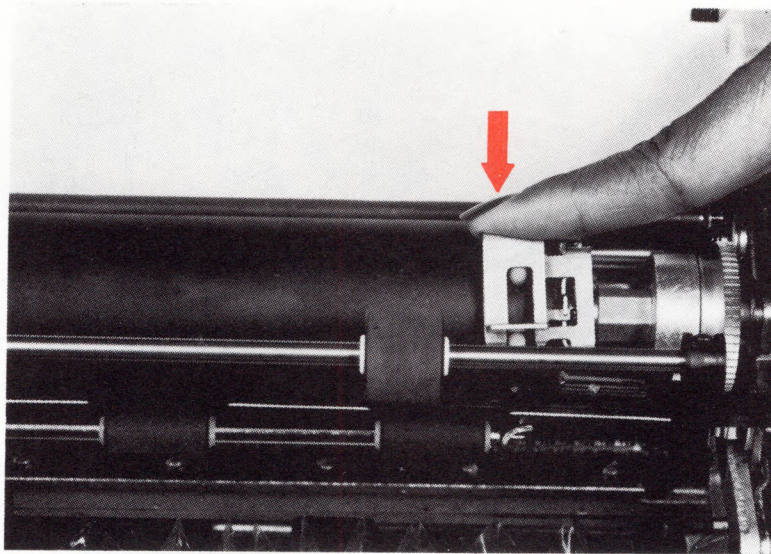

Open the printer cover

Push down on the paper clamps on each side of the platen to release the clamps for opening.

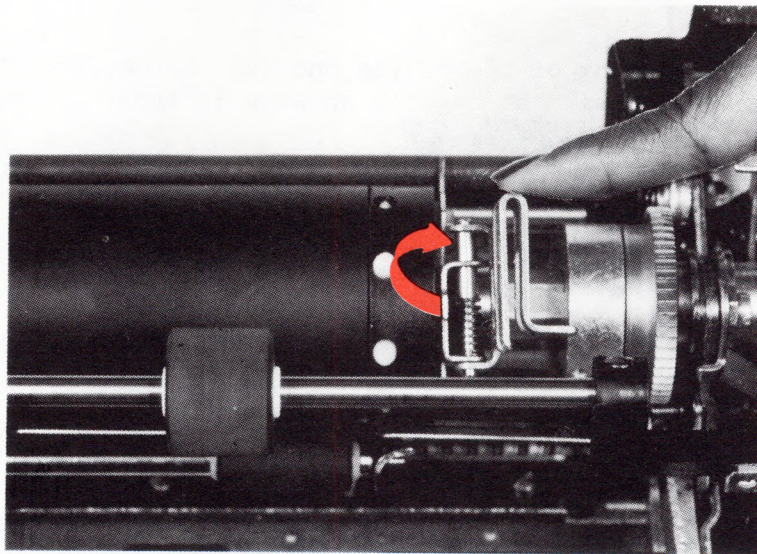

Open the right paper clamp to the right and the left clamp to the left.

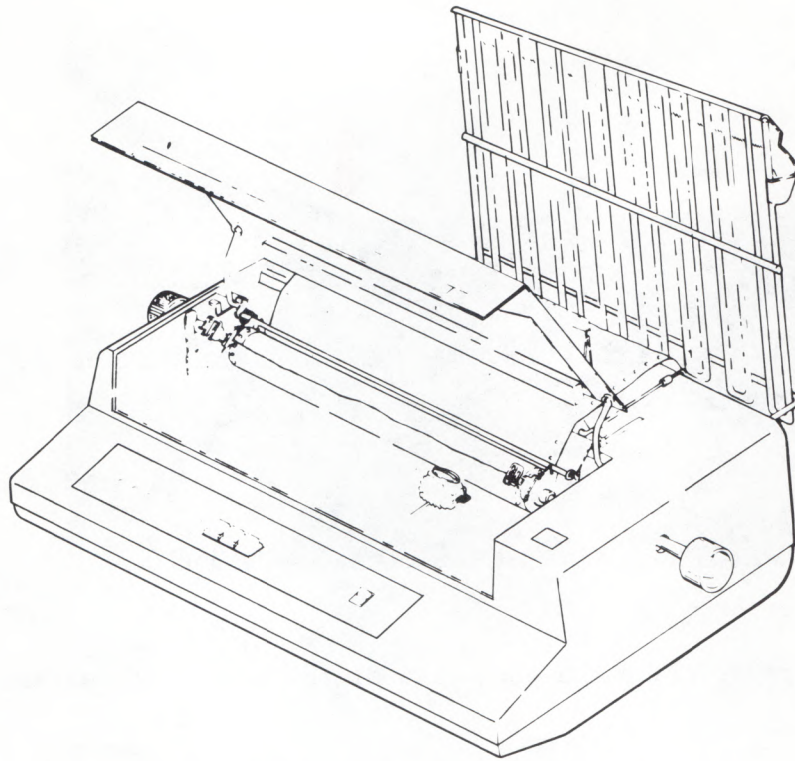

Insert the paper into the back of the platen and behind the Paper Bar (see page 17). Push the paper down until the edge is showing in front of the platen.

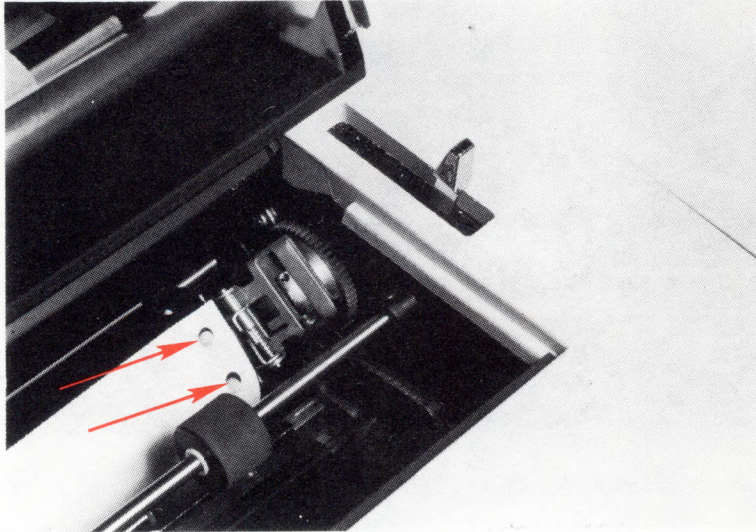

Pull the paper up to have enough to align the holes in the paper with the white pins on the platen.

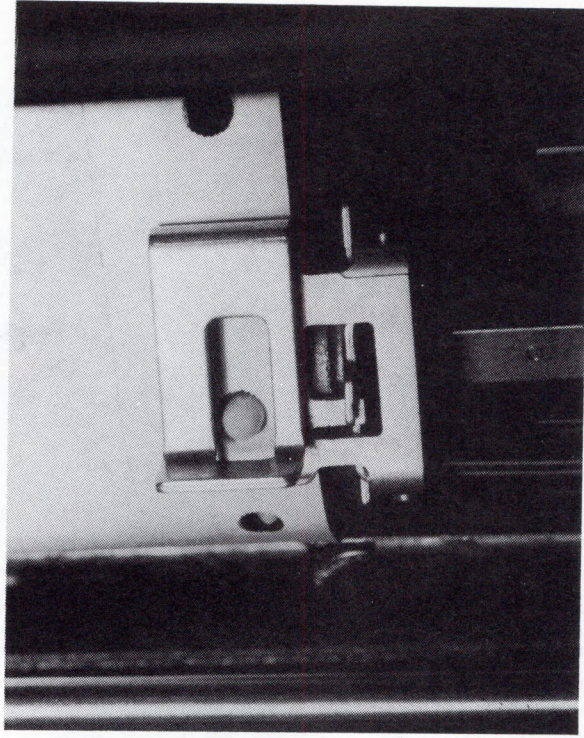

Close the paper clamps to secure the paper.

Close the paper bail. Close the printer cover.

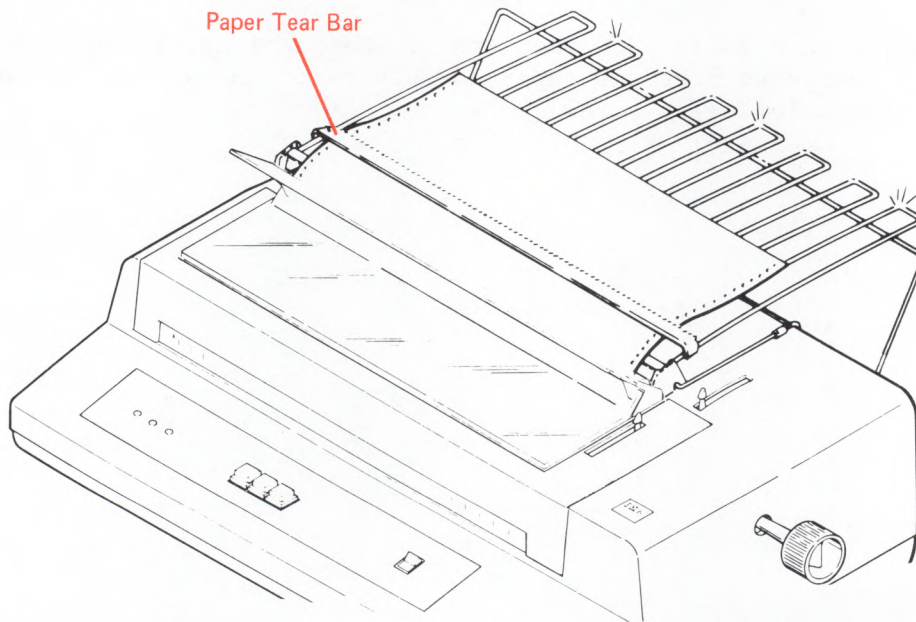

Guide the paper under the paper tear bar so that it rests on the Paper Separator Gate in the closed position.

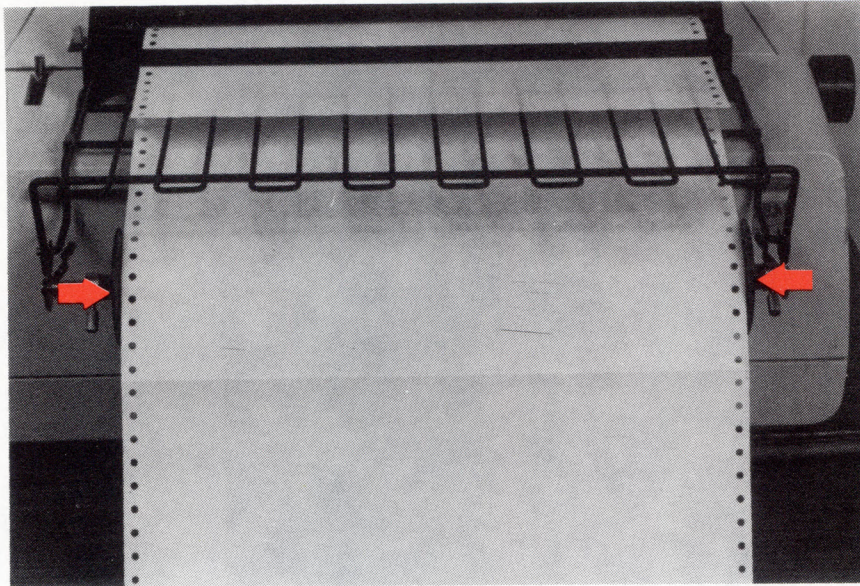

The photograph above shows the printer with paper guide rollers from the back.

- Adjust the paper guide rollers in the back of the printer to accommodate the width of continuous paper used in the printer.
- Unscrew the adjustable collars on each end of the paper and slide them to the side of the paper so that the paper loosely rest against the collars. Tighten the adjustable collar screws.

TO POSITION THE PAPER STACKER

As the paper falls from the Paper Separator, it should stack neatly into the top level of the paper stacker as shown in the illustration below.

- Position the paper stacker approximately 100 mm (4 inches) from the back of the printer.
- Place the continuous paper on the lower level of the paper stacker.
- After a few pages have printed, check to see that the paper is fan-folding neatly into place on the top level of the paper stacker.
- Periodically, check to make sure the paper is falling evenly into the stacker.

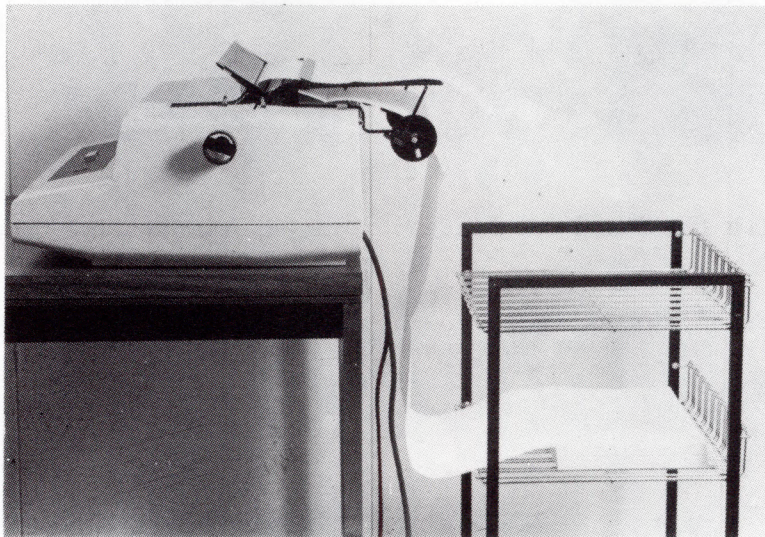

The Roll Paper Holder

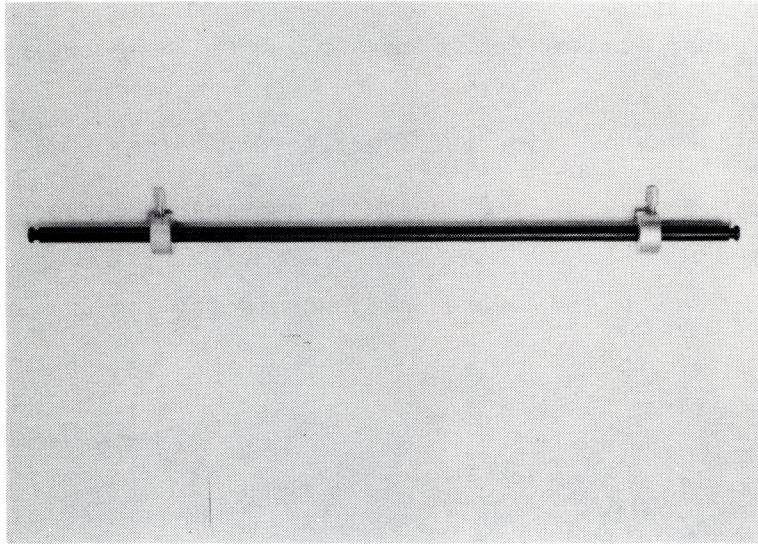

To use roll paper with the Pin-Feed Platen, roll paper must be attached to the holder.

Locate the roll paper holder as shown in the photograph above.

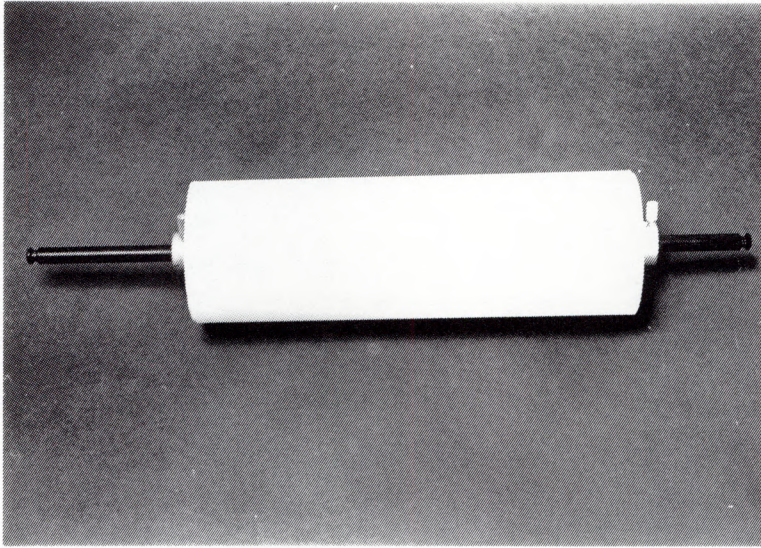

To install paper on the the roll paper holder:

- Remove one of the collar screws (donut-like clamps) from the paper holder.
- Insert the roll paper bar into the core of the roll paper.
- Re-install the collar screw.
- Insert the roll paper bar on the hooks on each side of the paper holder.

This page is intentionally left blank.

CHAPTER 4. MAINTAINING THE PRINTER

CLEANING THE PRINTER COVER

Use a soft brush to dust the carrier assembly.

Use only a mild liquid detergent to clean the plastic parts of the printer; certain cleaning fluids may be harmful. If stains persist, call your service representative.

CLEANING THE CARDHOLDER AND MARGIN SCALE

Use only a mild liquid detergent and damp cloth to clean the cardholder and margin scale.

CLEANING THE ELEMENT

Elements should be cleaned by using a dry brush. Clean the element by brushing up and away from you.

SERIAL NUMBER

You will need the printer serial number to identify your printer for service calls, inventories, or your own personal records.

To locate the serial number:

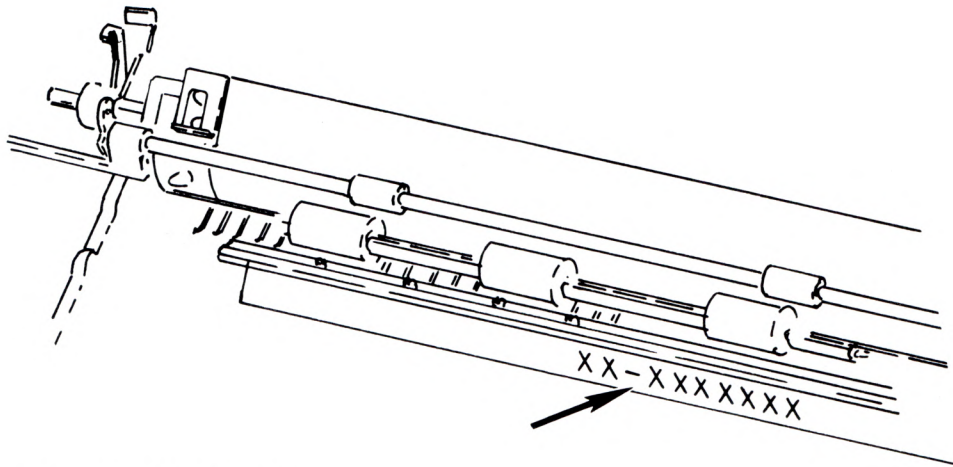

- Raise the printer cover.
- Move the carrier all the way to the left by hand.
- Locate the serial number directly below the platen to the left of the metal bar.

PART 2. IBM 5218 AND IBM 5228 PRINTWHEEL PRINTERS

Chapter 5.	Features of the IBM 5218 and IBM 5228 Printwheel Printers	37
Chapter 6.	Printwheel and Ribbon Cartridge	41
Chapter 7.	Changing the Ribbon	43
Chapter 8.	Changing the Printwheel	47
Chapter 9.	Inserting Cut Sheet Paper	53
Chapter 10.	IBM Tractor Feed	59
Chapter 11.	IBM Sheet-Feed Paper Handler	89
Chapter 12.	IBM Front Exit Sheet Feed	105
Chapter 13.	Supplies	127
Chapter 14.	Care and Cleaning	129

This page is intentionally left blank.

CHAPTER 5. FEATURES OF THE IBM 5218 AND IBM 5228 PRINTWHEEL PRINTER

The IBM 5218 or IBM 5228 Printwheel Printer is a key part of your IBM Displaywriter System. With it, you will be able to print documents you create at your work station.

Both the IBM 5218 and IBM 5228 Printwheel Printers are bi-directional impact printers that use several different 96-character printwheel cartridges. Printwheel cartridges are color-coded and available in 10 pitch (10 characters/inch), 12 pitch (12 characters/inch), 15 pitch (15 characters/inch) and PSM (proportional spacing). The maximum printing line for the IBM 5218 printer is 335.28 mm (13.2 inches). The maximum printing line for the IBM 5228 Printer is 432 mm (17.0 inches).

The IBM 5218 and IBM 5228 Printwheel Printers are available in the following models:

- 5218-A01 which has a rated burst print speed of up to 40 characters per second in 10 pitch.
- 5218-A02 which has a rated burst print speed of up to 60 characters per second in 10 pitch.
- 5218-A03 which has a rated burst print speed of up to 40 characters per second in 10 pitch.
- 5218-A04 which has a rated burst print speed of up to 60 characters per second in 10 pitch.
- 5228-A12 which has a rated burst speed of up to 60 characters per second in 10 pitch.

Unless otherwise stated, all features and operations described in this guide apply to all printer model numbers.

HOW TO USE THIS SECTION OF THE PRINTER GUIDE

This section describes the parts of the IBM 5218 and IBM 5228 Printwheel Printers and how to:



- Insert paper into the printer
- Remove and install a ribbon
- Change a printwheel cartridge
- Install and use each optional feature

The term IBM 5218/IBM 5228 will refer to either printer throughout this manual. Each optional feature is discussed in separate chapters. Refer to the chapter heading that pertains to the type of feature you need to learn about.

When you begin to print, certain prompts and messages will appear on the display. To learn more about what they mean, refer to the "Prompts and Messages" section of the Operator Reference Guide or the Prompts and Messages Guide.

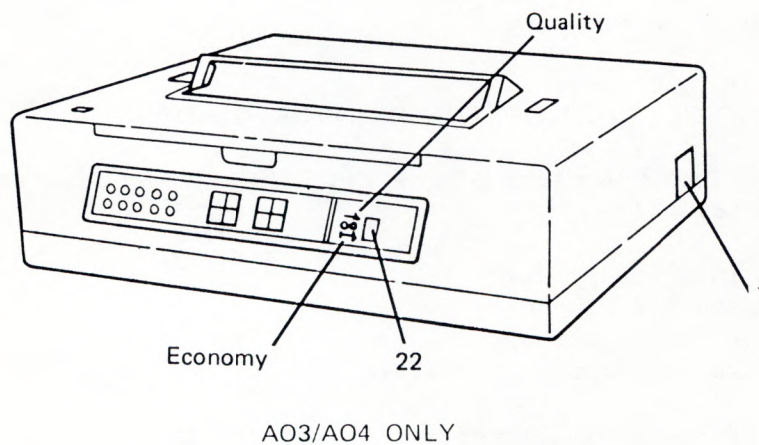
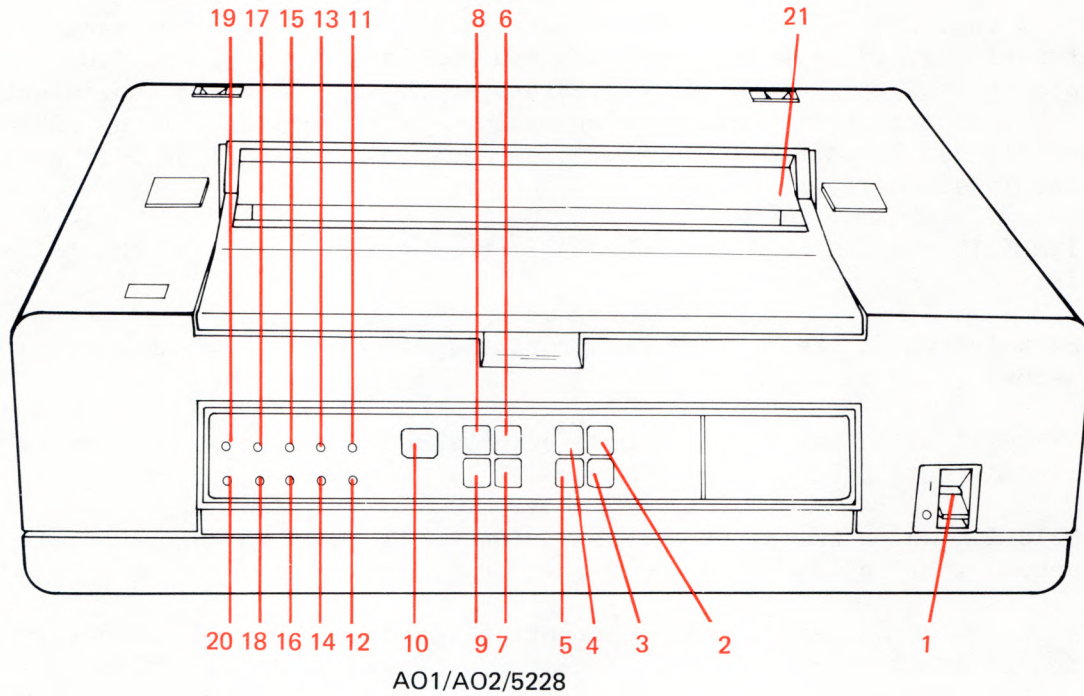
If you have more than one work station attached to a printer, refer to "Sharing a Printer" in Topic 4 of the Operator Training Book 1 -- Basic Topics or the "Printer Sharing Procedures" Chapter of the Work Station Procedures Guide.



1. Power Switch
Supplies power to the printer. Press the switch to the (I) for ON and to the (O) for OFF. When the printer is turned on, it performs a diagnostic check for about 15 seconds. DO NOT open the printer cover during the check. When the check is completed, the printwheel moves to the center of the platen. If the printer is turned OFF wait ten seconds before turning ON.
2.  (Paper Advance)
Used to advance paper in the printer. When pressed, the paper will advance 0.5 mm (1/48 in.). Continued depression will advance the paper 3.7 mm (7/48 in.). If held down continuously, the paper advances in 4.2 mm (1/6 inch) increments.
3.  (Paper Return)
Used to move paper backwards in the printer. When pressed, the paper will return 0.5 mm (1/48 in.). Continued depression will return the paper an additional 3.7 mm (7/48 inches) increments. If held down continuously, the paper returns in 4.2 mm (1/6 in.) increments.
4. Load
When paper is inserted in the printer and Load is pressed, the paper will advance to the top of the cardholder, (for details see "Chapter 9.")
5. Release
Used to release the feed rollers and the paper bail for paper adjustments or paper removal. The first depression opens the feed rollers and the paper bail, the second depression closes the feed rollers and the paper is held in place. This button works only if the Ready light is off.
6. Print Test
When pressed, all the characters on the printwheel should print like the sample below. This test, which varies for each type style, enables you to check the print quality and verify that the printer will print.

abcdefghijklmnopqrstuvwxyzABCDEFGHIJKLMNOPQRSTUVWXYZ0123456789
 , ± ½ § ¶ c] ³ ² " = ' : . ? _ % , # / - [;) * \$ & ! + (. ¼ @

Note: The statistic log prints after the print test on the A03 and A04 models.

- | | |
|-----------------------------|---|
| 7. Cancel | Used to cancel the present job and allow the next job to begin printing. |
| 8. Start | Press to begin printing. |
| 9. Stop | When pressed, printing stops. Press Start to resume printing. |
| 10. Two-digit Display | Used during problem determination and indicates printer error conditions and printer exceptions. |
| 11. Change Font Light | Not used. |
| 12. Diag Mode | Used by service personnel only. |
| 13. Setup Light | Indicates that paper in the printer must be removed. If the IBM Tractor Feed is installed, vertical alignment of the next form is required. |
| 14. Load Paper Light | Not used. |
| 15. Printer Exception Light | Indicates that a printer error has occurred. The error will be identified by a message or prompt on the display and explained in the <u>IBM Displaywriter System 5218/5228 Printwheel Printer Problem Determination Guide</u> . |
| 16. Release Light | Indicates the paper bail and the feed rollers have been opened to adjust or remove paper manually. |
| 17. Ribbon Light | Indicates that the ribbon needs changing. The message Change Printer Ribbon will also show on the display. The light will remain on until a new ribbon cartridge is installed. |
| 18. Ready Light | Indicates that the printer is ready to print. |
| 19. Power On Light | Indicates that the printer has been turned on. |
| 20. On Line Light | Indicates that the printer is ready to print documents from the IBM Displaywriter System. |
| 21. Sound Shield | Reduces printing sound and protects ribbon area. |
| 22. Ribbon Saver Switch | Used to select an increase ribbon yield. When the switch is set to quality, ribbon life will be approximately 1 million characters per ribbon cartridge. When the switch is set to economy, ribbon life will be approximately 3 million characters per ribbon cartridge with a decrease in print quality. |

CHAPTER 6. PRINTWHEEL AND RIBBON CARTRIDGE

Lift the printer cover to locate the features shown in the photograph below.

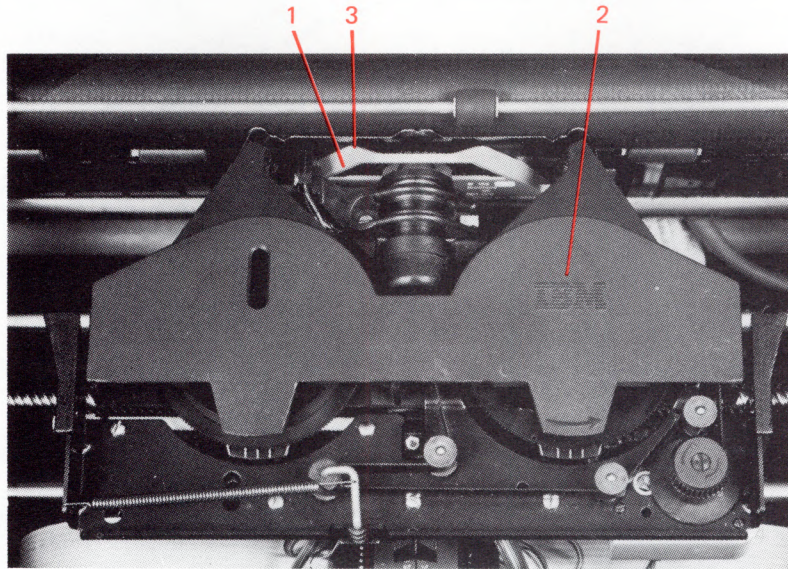

1. **Printwheel Cartridge** -- contains the printwheel needed to print a document.
2. **Ribbon Cartridge** -- contains the printer ribbon.
3. **Cardholder** -- secures paper, small cards, and short sheets of paper against the platen and shows where characters will print. It also serves as a reference point for lining up the paper.

This page is left blank intentionally.

CHAPTER 7. CHANGING THE RIBBON

When the change Printer Ribbon message shows on the display, the ribbon light will turn on. Use the following steps as a guide to complete removing and installing a printer ribbon.

TO REMOVE A RIBBON

Turn the printer power on.

Open the printer cover.

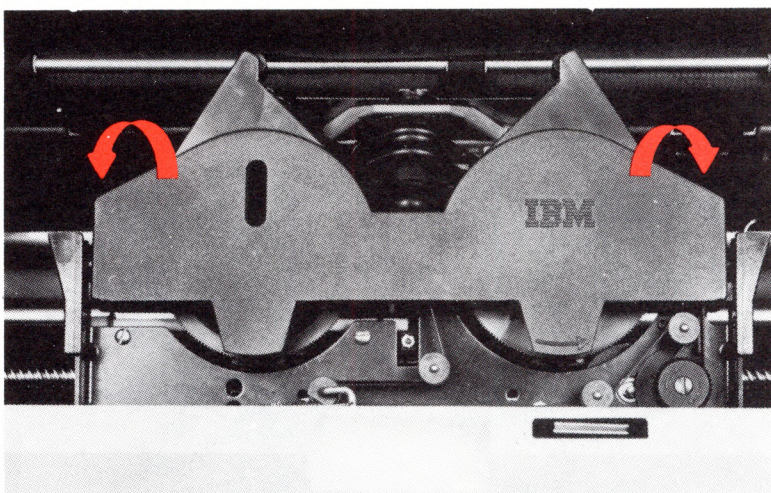

Tilt the ribbon cartridge toward the front of the printer. A small amount of ribbon may remain on the cartridge.

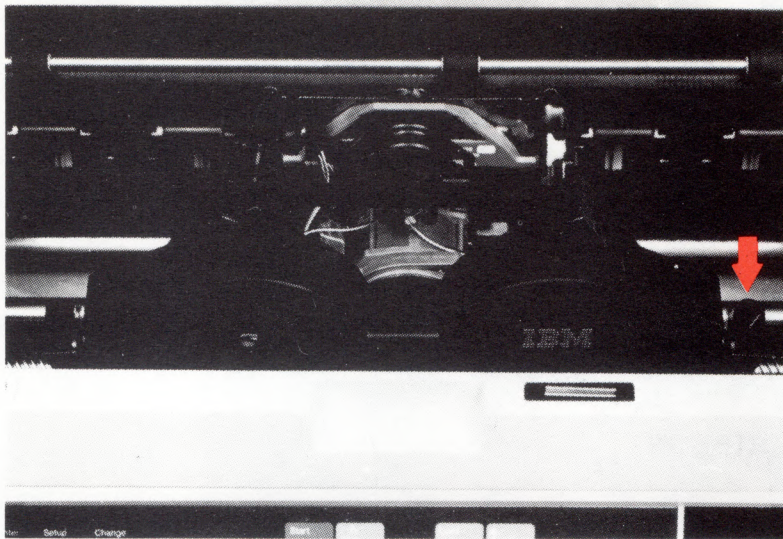

Press down on the tab to the right of the ribbon mechanism to release the ribbon cartridge.

Lift the cartridge out.

TO INSTALL A NEW RIBBON

To install a new ribbon, follow these steps:

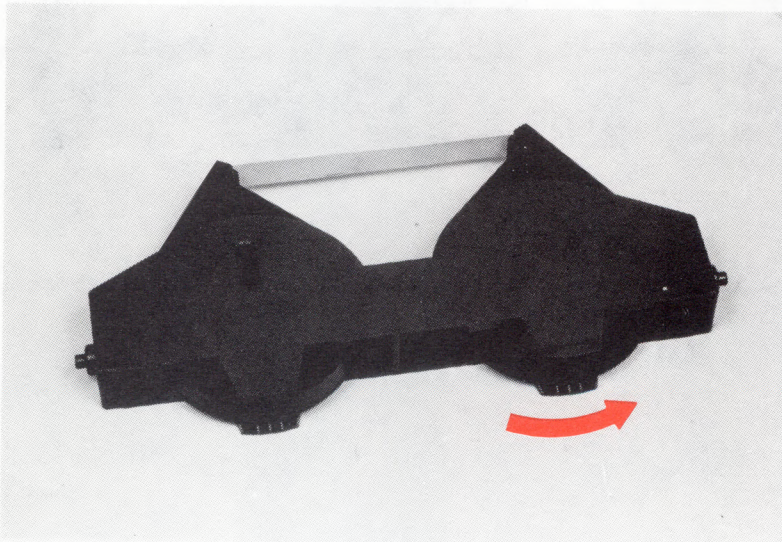

Turn the right spool to remove any slack in the ribbon.

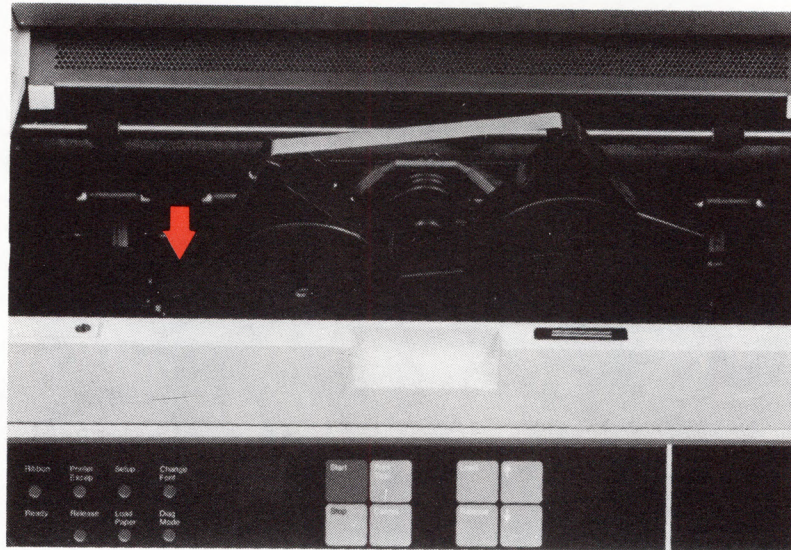

Insert the left edge of the ribbon cartridge into the left slot.



Insert the right edge of the ribbon cartridge into the right slot.
Press down until the cartridge clicks into place.

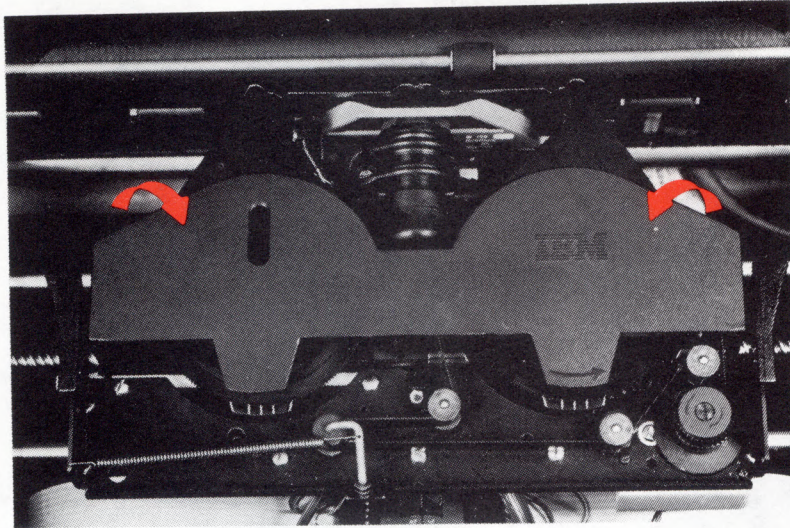

Lay the ribbon cartridge down to the print position.

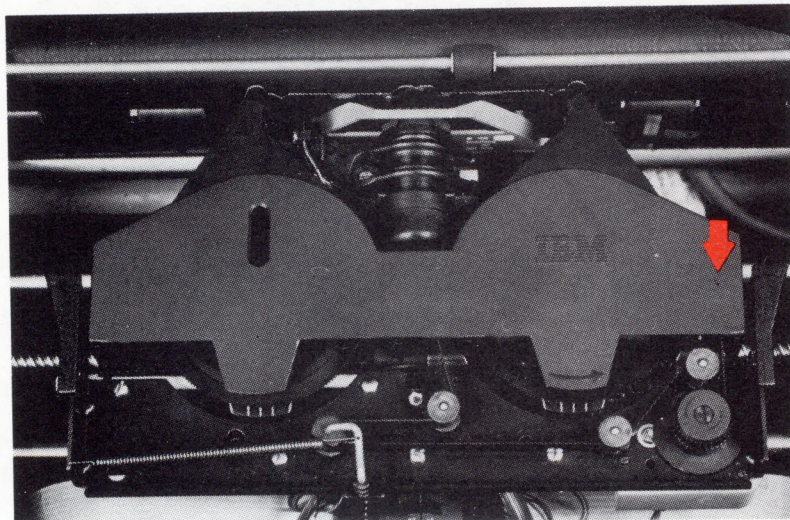

Turn the ribbon advance knob clockwise past the leader portion of the ribbon.

Close the printer cover and press Start. If the Ready light does not go on, refer to the IBM Displaywriter System 5218/5228 Printwheel Printer Problem Determination Guide.

CHAPTER 8. CHANGING THE PRINTWHEEL

The Printwheel contains the characters needed to print a document on the IBM 5218/IBM 5228 Printwheel Printer. In this chapter you learn how to install and remove a printwheel.

PRINTWHEEL DESCRIPTIONS

Look at the photograph below and read the description of the parts of the printwheel cartridge that follow:

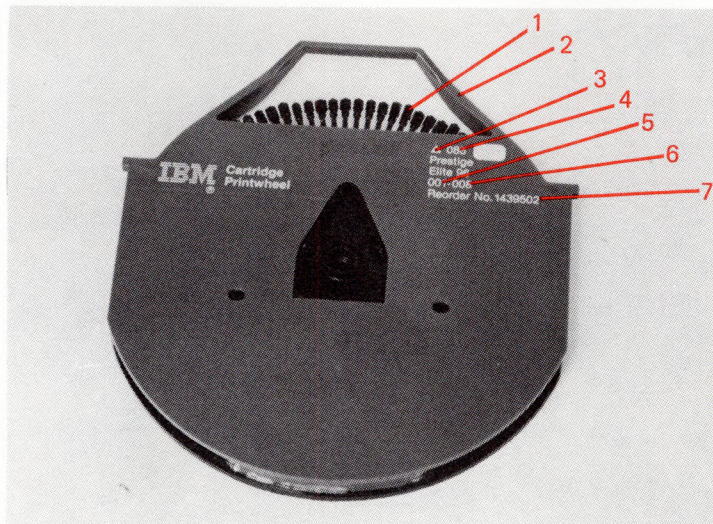

1. **Printwheel** -- contains the characters needed to print a document.
2. **Printwheel Cartridge** -- Holds the printwheel.
3. **Pitch Indicator** -- Shows how many characters per inch a document will print.

- = 15 Pitch (15 characters/inch) -- Blue
- △ = 12 Pitch (12 characters/inch) -- Green
- ▲ = 10 Pitch (10 characters/inch) -- Red
- = Proportional Spacing -- Orange

4. **Type Style Name** -- Identifies the number which corresponds to the type style being used.
5. **Type Style Name** -- The name assigned to a particular type style.
6. **Keyboard ID Number** -- Indicates range of keyboards supported by the printwheel used.
7. **Re-order Number** -- Used for ordering additional printwheels.

TO REMOVE A PRINTWHEEL CARTRIDGE

To remove a printwheel cartridge, use the illustration and the steps that follow:

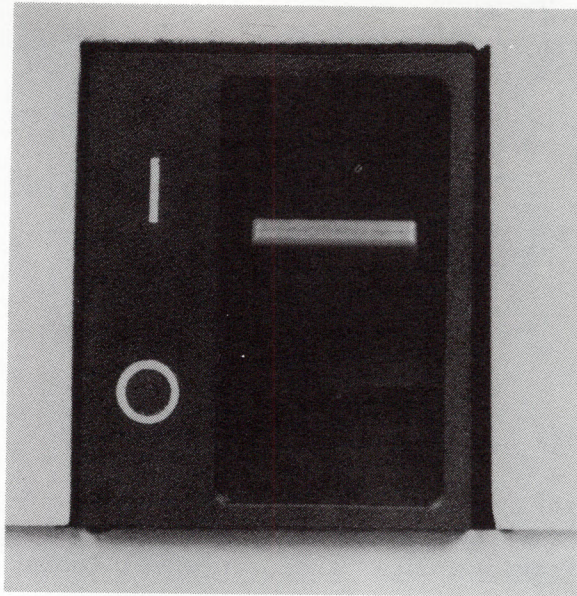

Make sure the printer power is on.

Open the printer cover.

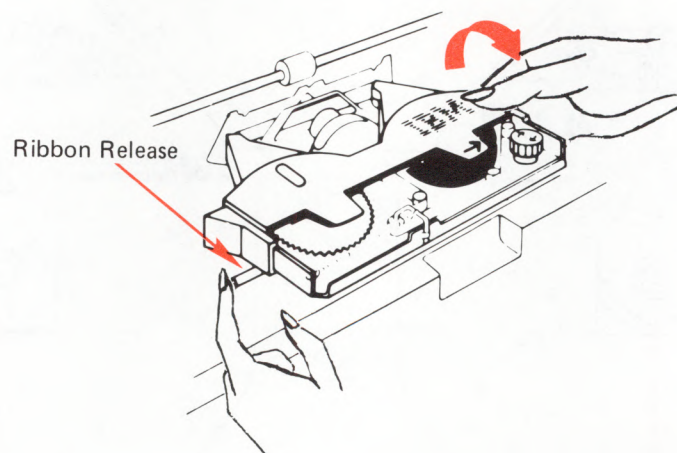

Press and hold the ribbon release located to the left of the ribbon cartridge while tilting the ribbon mechanism. Do not remove the ribbon.

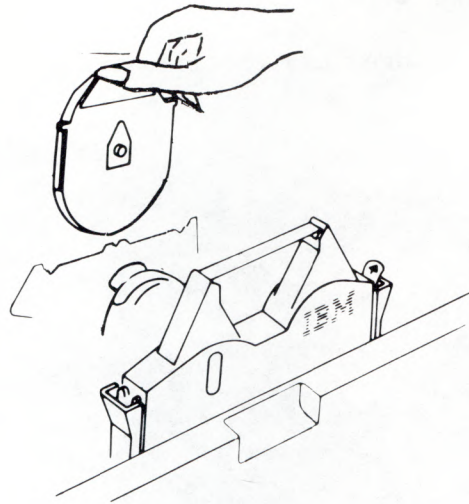

Grasp the printwheel cartridge handle and lift up.

Note: Before inserting another printwheel, make sure the printwheel is positioned correctly in the cartridge. If it is not correctly positioned, move the printwheel inside the cartridge until the printwheel looks like the illustration below.

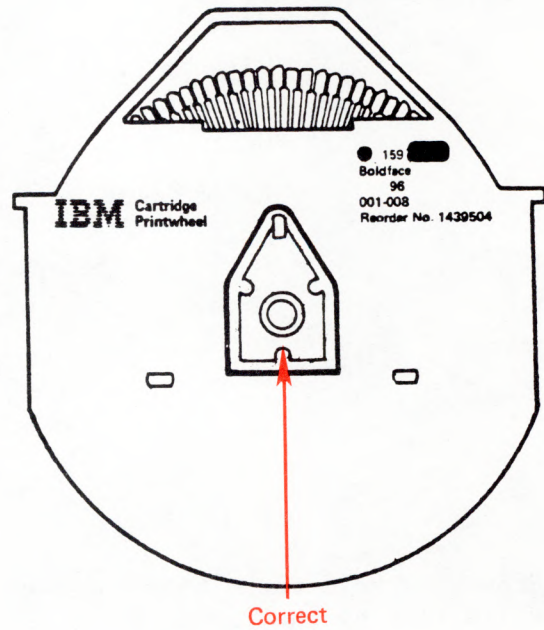
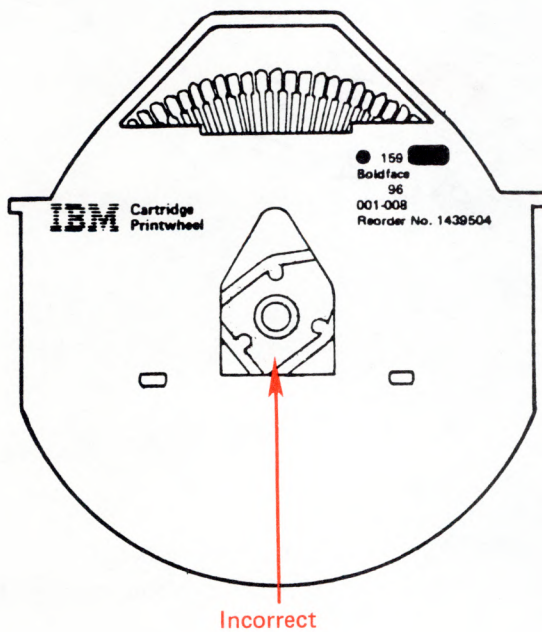

TO INSERT A PRINTWHEEL CARTRIDGE

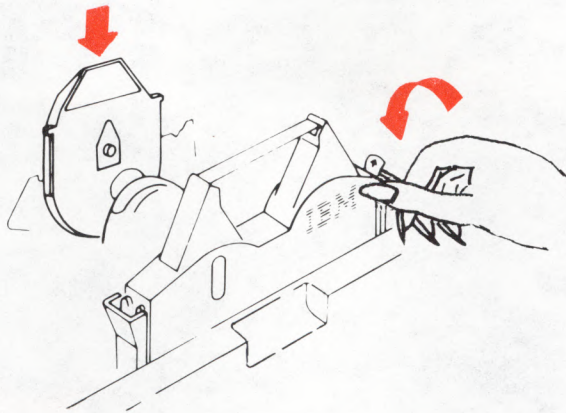

Place the printwheel cartridge in the upright position.

Insert the cartridge into the slot.

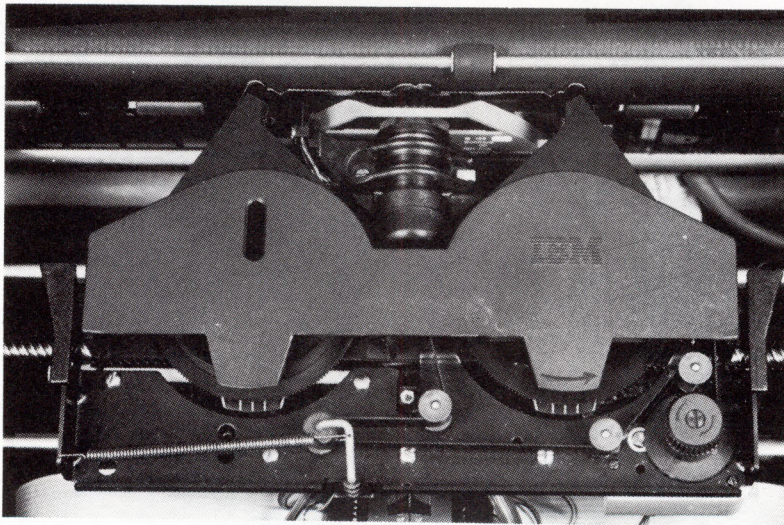

Lay the ribbon cartridge down to the print position. Do not press the top of the ribbon cartridge.

Make sure the ribbon is not caught in the printwheel.

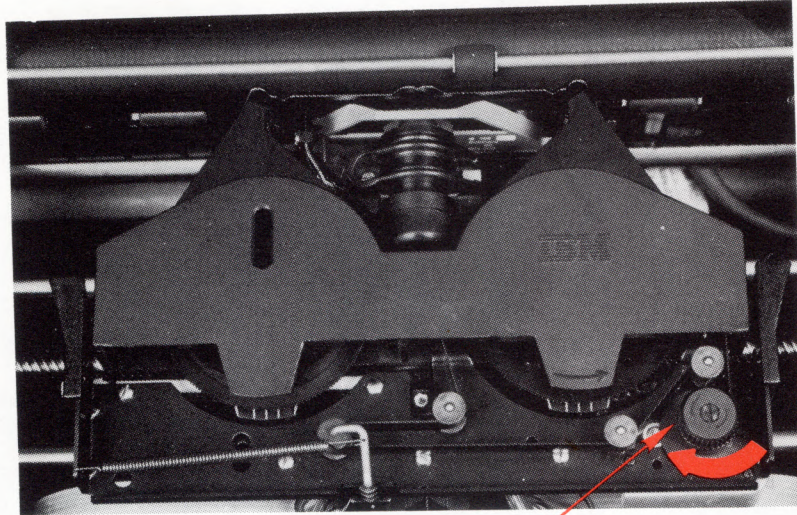

Ribbon Advance Knob

Turn the ribbon advance knob clockwise to remove any slack in the ribbon.
Close the printer cover and press Start.

CHAPTER 9. INSERTING CUT SHEET PAPER

When you see the Load Cut Paper or Envelope Size (width x length) inches message on the display, it is time to load paper.

INSERTING CUT SHEET PAPER INTO A PRINTER WITHOUT A PAPER SUPPORT

TABLE

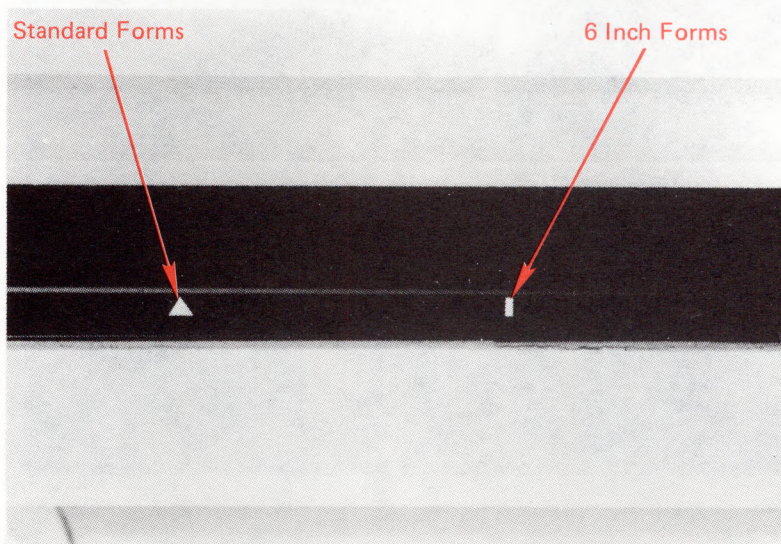

Locate the ▲ and the ■ on the top of the printer. IBM 5218

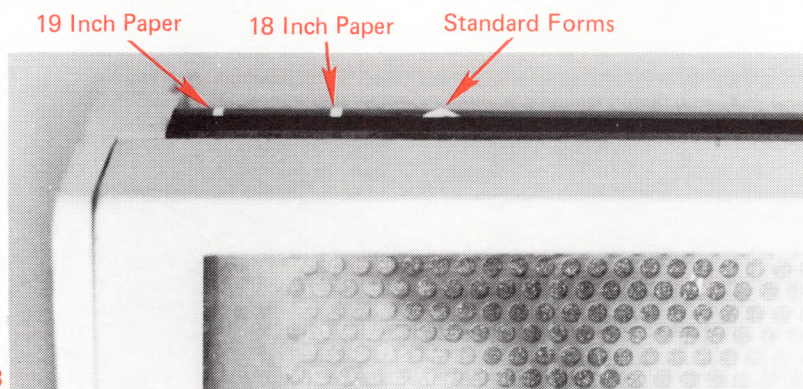

Align the left edge of the paper with the ▲ on the top of the printer. If your paper is less than 150 mm (6 inches) wide, use the ■ to align the left edge of the paper.

Note: On the IBM 5228 Printer, if you are using paper widths of 18 or 19 inches, the left edge of the paper should be aligned with the appropriate ■ to the left of the ▲ as shown at the beginning of this chapter. Then align the paper guide with the paper edge.

Press Load. The paper will index to the top of the cardholder.

The left V notch on the card holder indicates the first possible print position. The center V notch on the card holder indicates the first possible print position for paper less than 150 mm (6 inches) wide. If more precise horizontal alignment is required, press the RELEASE button and realign the paper.

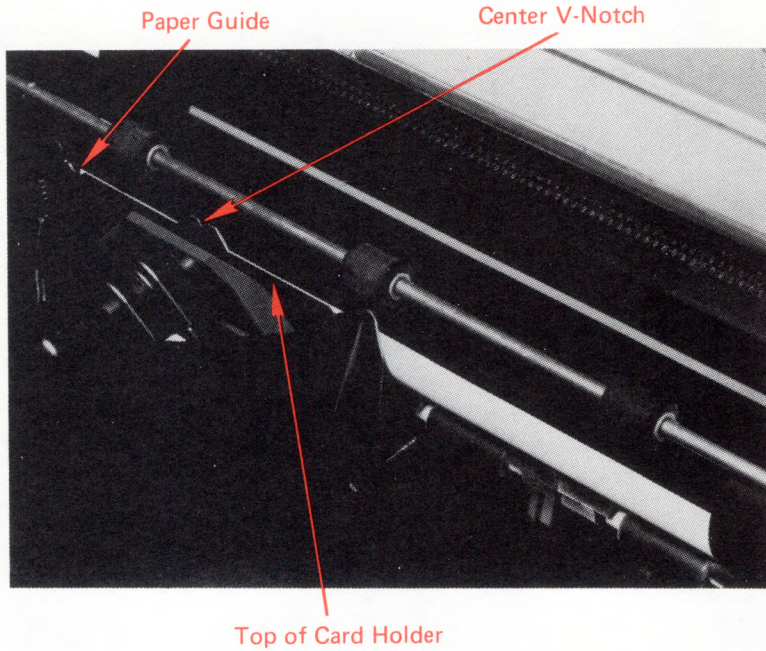

PAPER SUPPORT TABLE INSTALLATION

If you have a Paper Support Table, install the table as shown below, then insert paper:

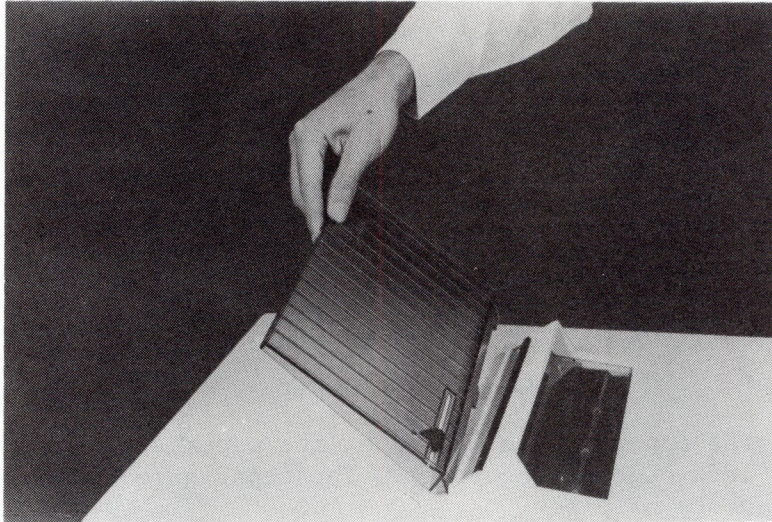

Insert the tabs at the bottom of the Paper Support Table into the slot behind the paper entry bar.

INSERTING PAPER WITH A PAPER SUPPORT TABLE ATTACHED

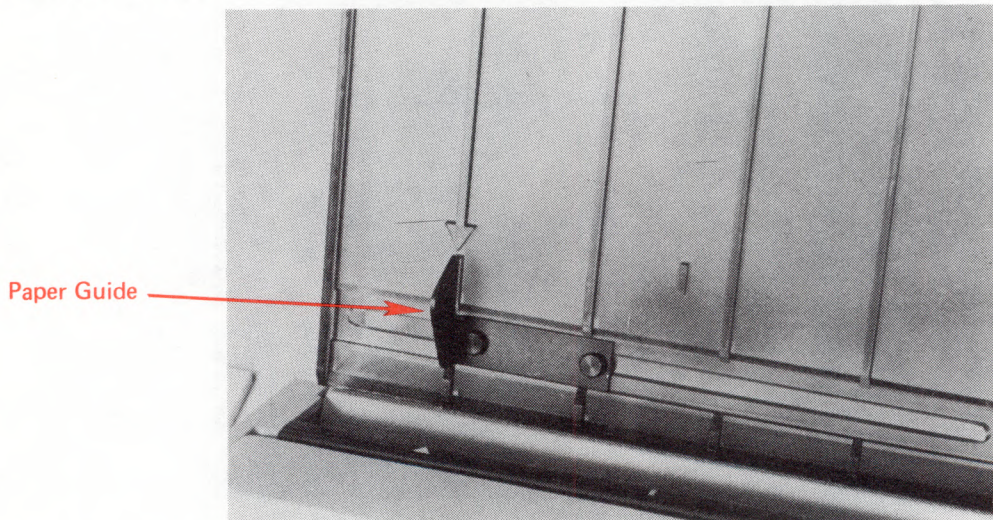



Locate the ↓ and the ■ on the paper support table.

Slide the paper guide to the ↓. If paper is less than 150 mm (6 inches) wide, line up the paper guide with the ■ on the table.

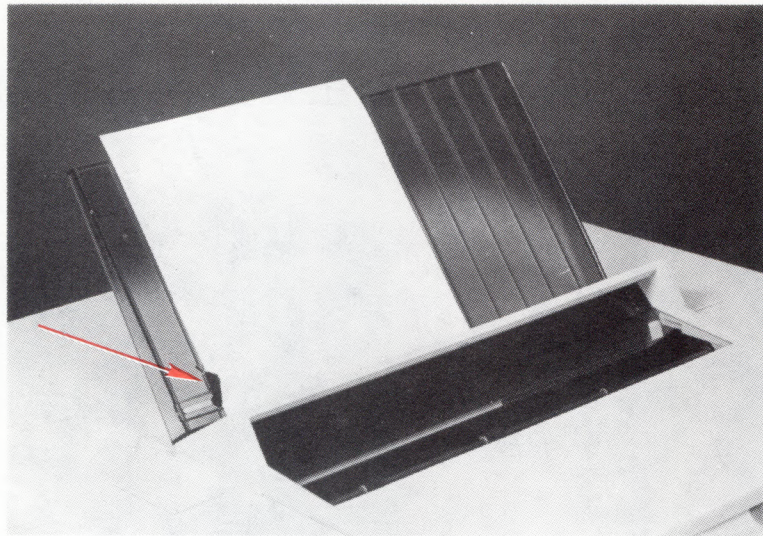
Note: On the IBM 5228 Printer, if 18- or 19-inch paper is being used, the paper edge should be aligned with the marks on the acoustic filter and then align the paper guide with the paper edge. See the illustration at the beginning of this chapter for the location of the paper alignment marks on the 5228.



Align the left edge of the paper with the  on the paper table or the  on the table to line up the left edge of the paper. The paper guide can be used to position subsequent sheets of paper.

Press Load, and the paper will index to the top of the cardholder.

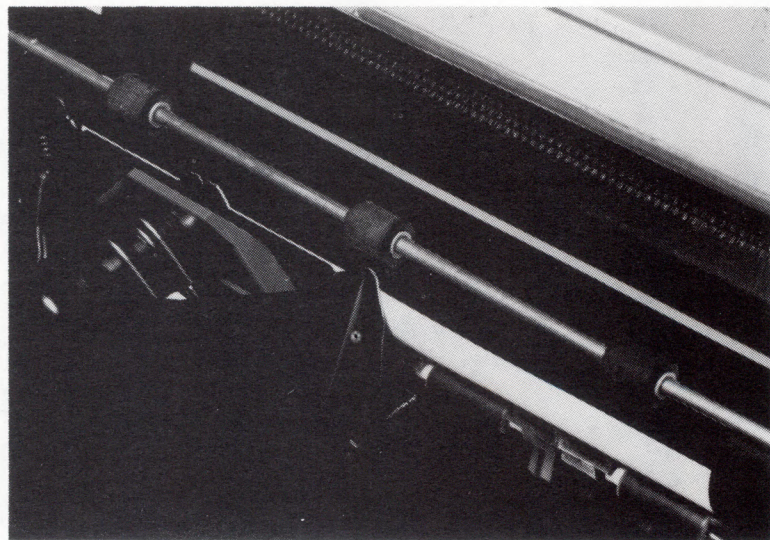

TO REMOVE CUT SHEET PAPER FROM THE PRINTER

To remove cut sheet paper from the printer, follow these steps:

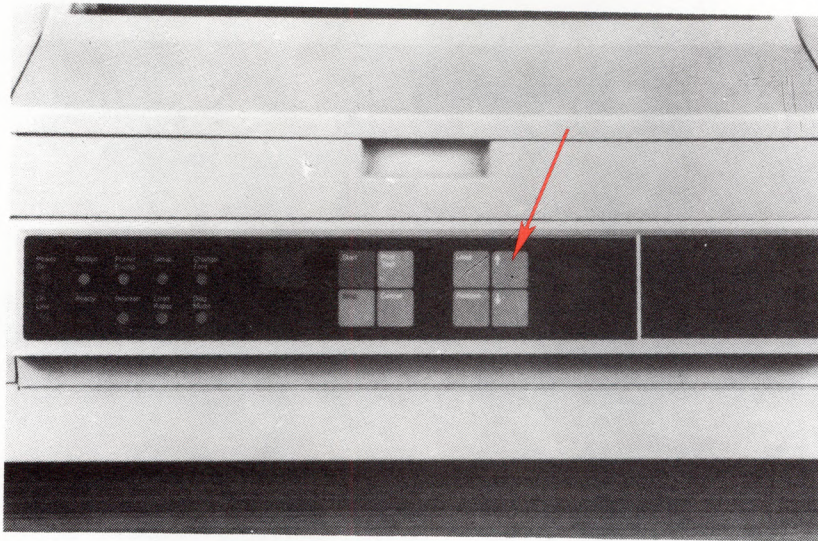

Press and hold the  button until the paper indexes out of the printer.

OR

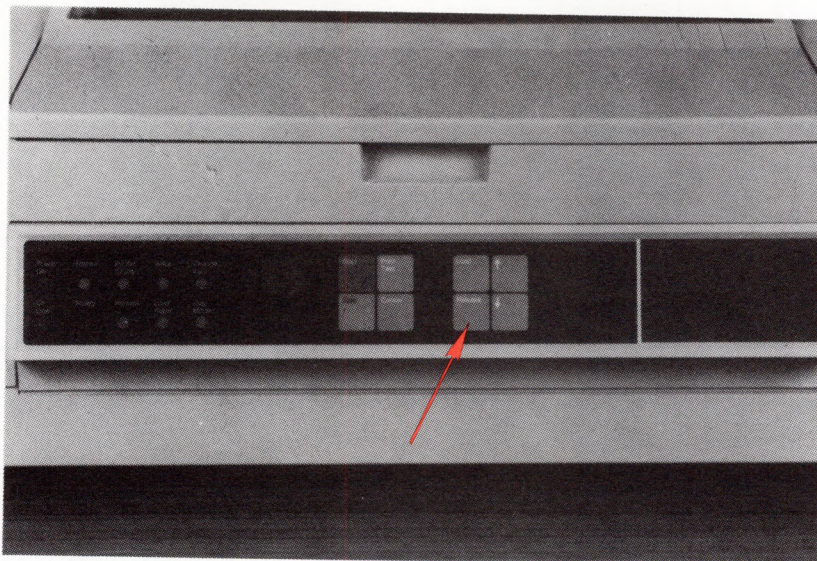

Press Release, remove the paper, and then press Release again.

This page is intentionally left blank.

CHAPTER 10. IBM TRACTOR FEED

If the IBM Tractor Feed is needed to print continuous-form paper, you will learn in this chapter how to install and remove the Tractor Feed and how to install and remove paper from the Tractor Feed.

INSTALLING THE IBM TRACTOR FEED

To install the IBM Tractor Feed, follow these steps:

- Turn the printer power OFF (O).
- Remove the paper Support Table, IBM Sheet-Feed Paper Handler, or IBM Front Exit Sheet Feed if installed.
- Slide the printer to the rear edge of the table.

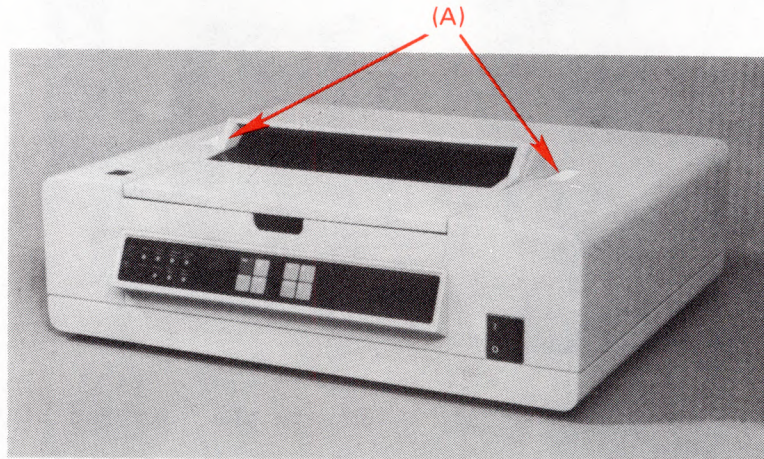

Remove the cover inserts (A) if they are in place.

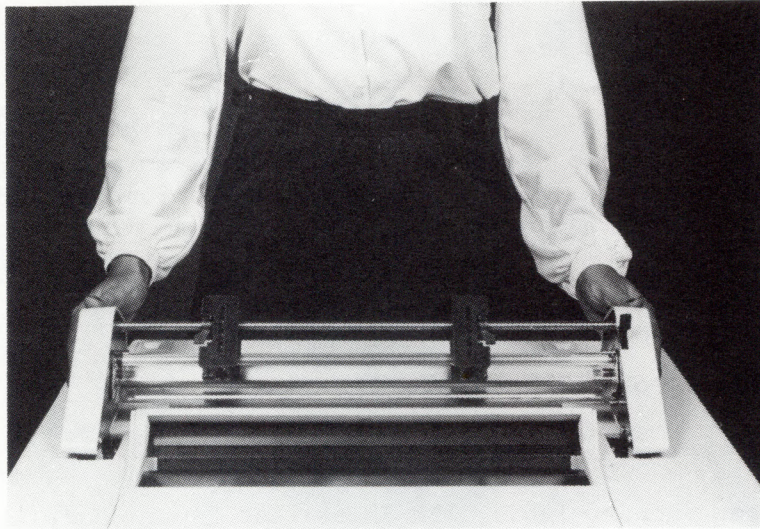

Place the IBM Tractor Feed onto the printer.

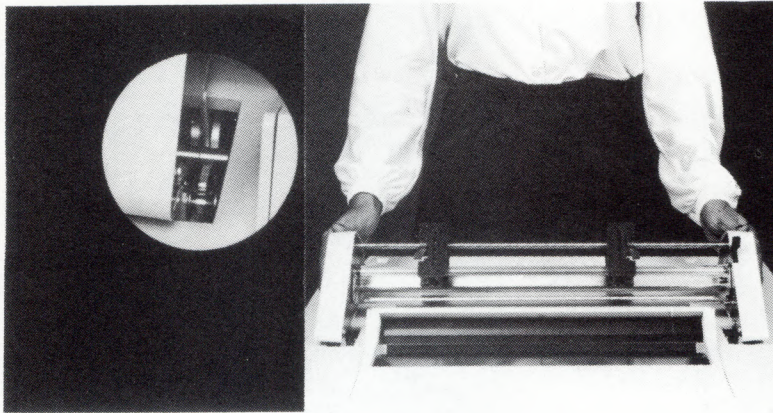

Insert the front pins into the front slots on both the left and right sides of the tractor feed mechanism.

Rotate the IBM Tractor Feed back until it rests on the printer cover.

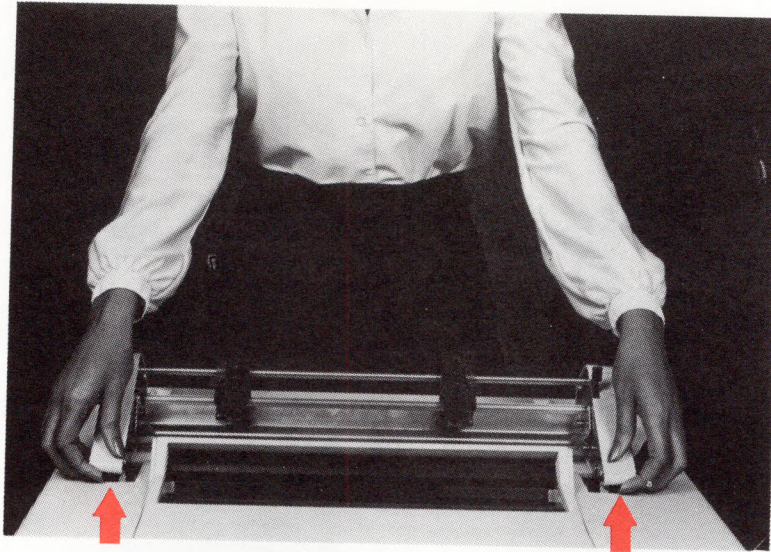

To make sure the IBM Tractor Feed is properly installed, lift the front of the device. If the IBM Tractor Feed lifts away from the printer, follow the previous steps to re-install.

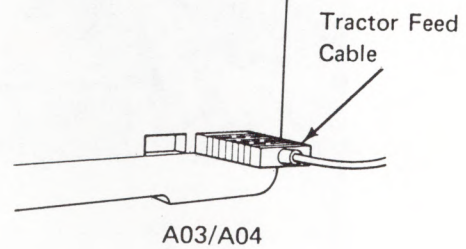
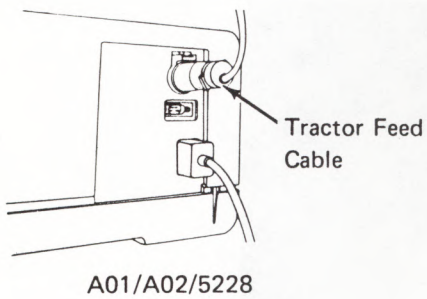

Connect the IBM Tractor Feed cable plug into the printer cable socket.

Note: Some printers may need an adapter cable to connect the tractor feed to the printer. If required, attach the adapter cable as shown.

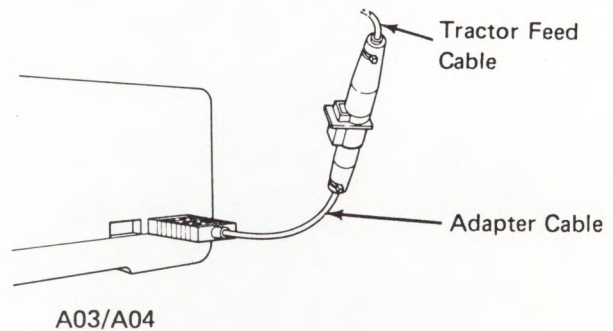
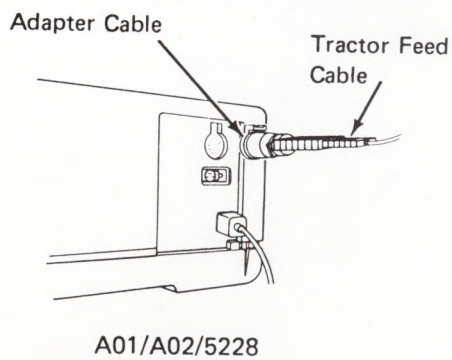

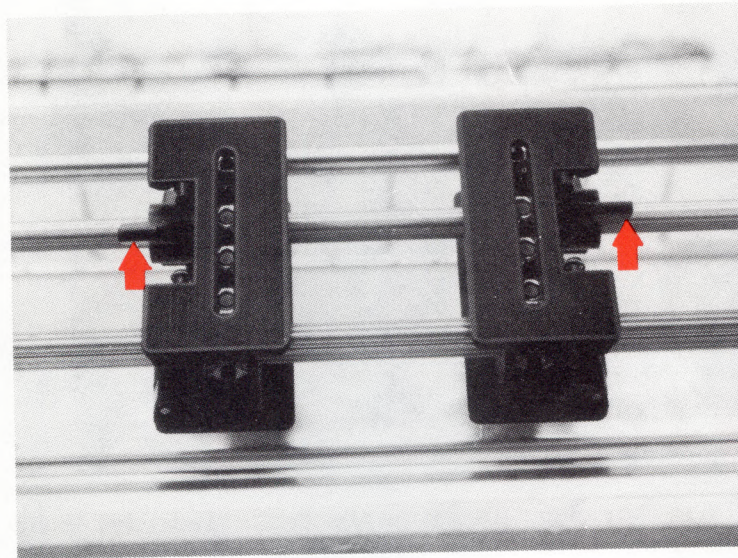

Unlock both tractors by rotating the latches forward and up.

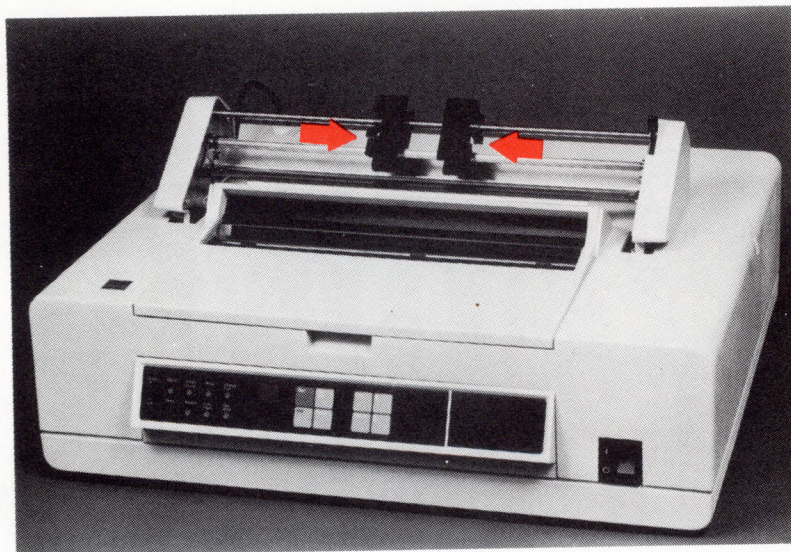

Move the tractors away from the extreme edges of the tractor assembly.

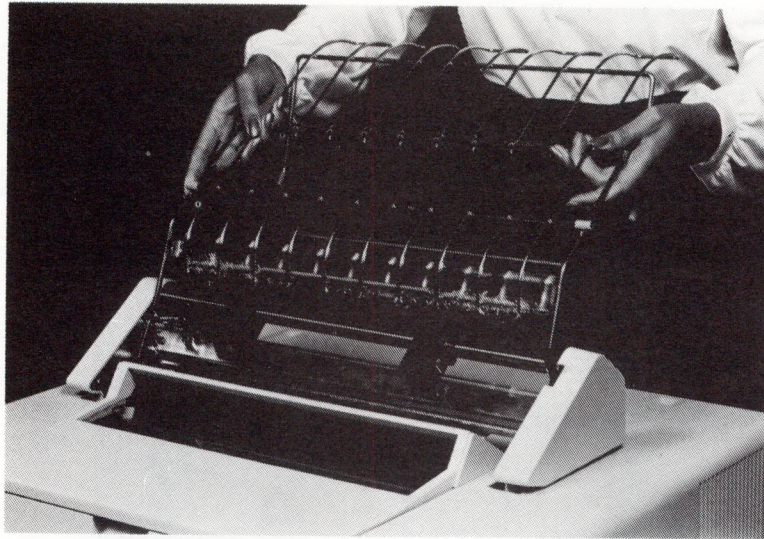

Install the Paper Separator as illustrated.

Hook Style

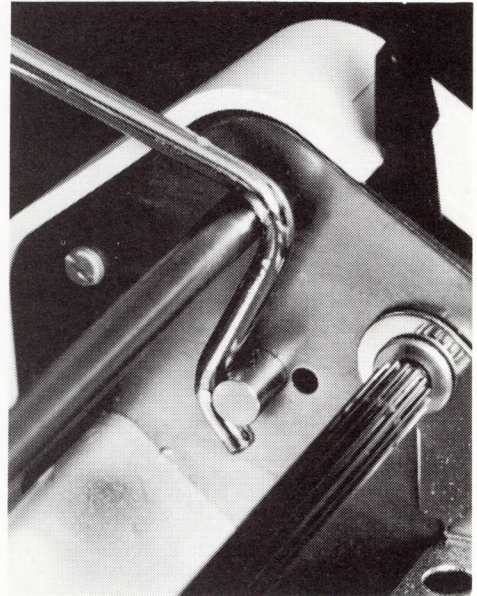

Loop Style

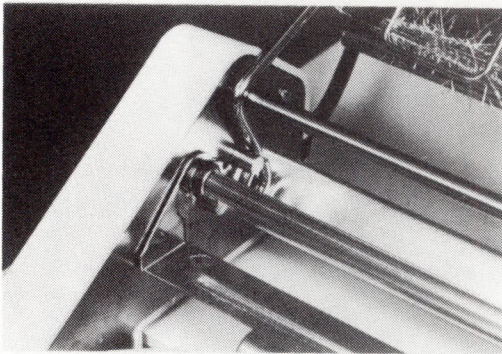

On the loop style make sure that the wire loops are behind the metal posts. DO NOT position the wire loop around the metal post. Rotate the Paper Separator back to its rest position.

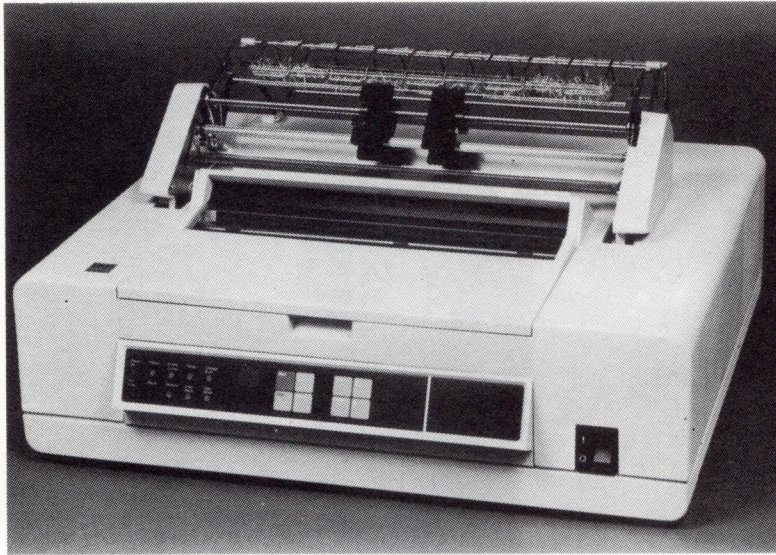

After installation, the tractor assembly should appear as shown.

LOADING PAPER INTO THE IBM TRACTOR FEED

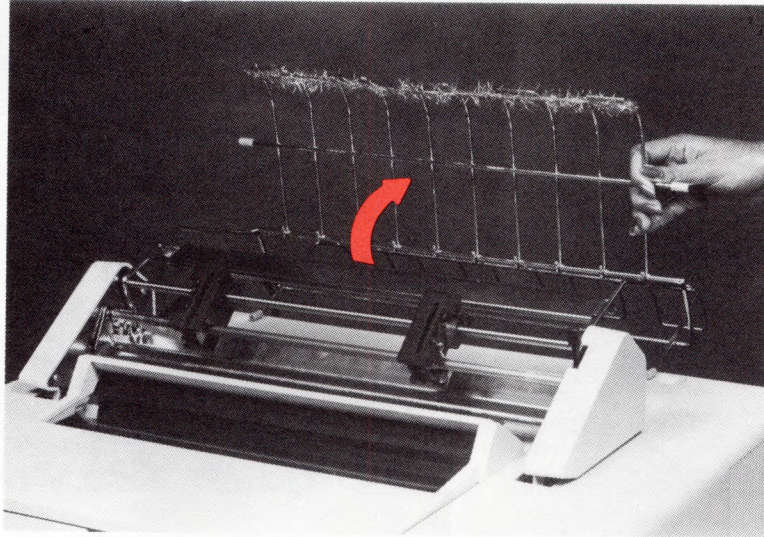

1. Open the Paper Separator Door.

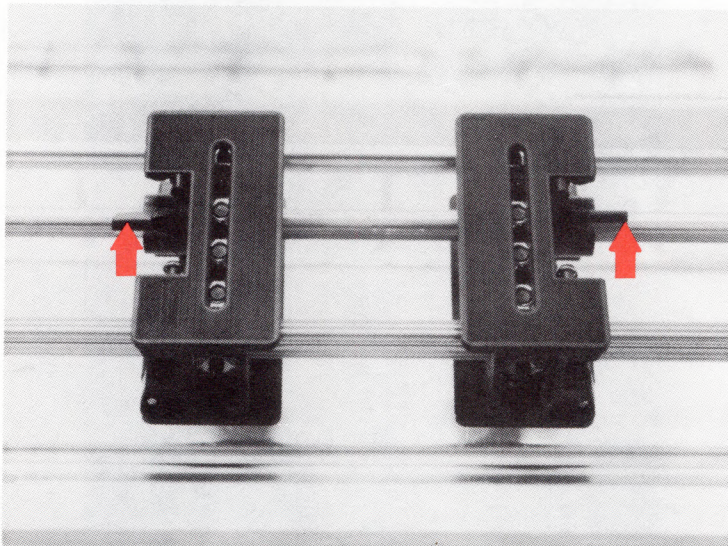

2. If the latches are locked, rotate them up on both tractors as shown in the photograph.

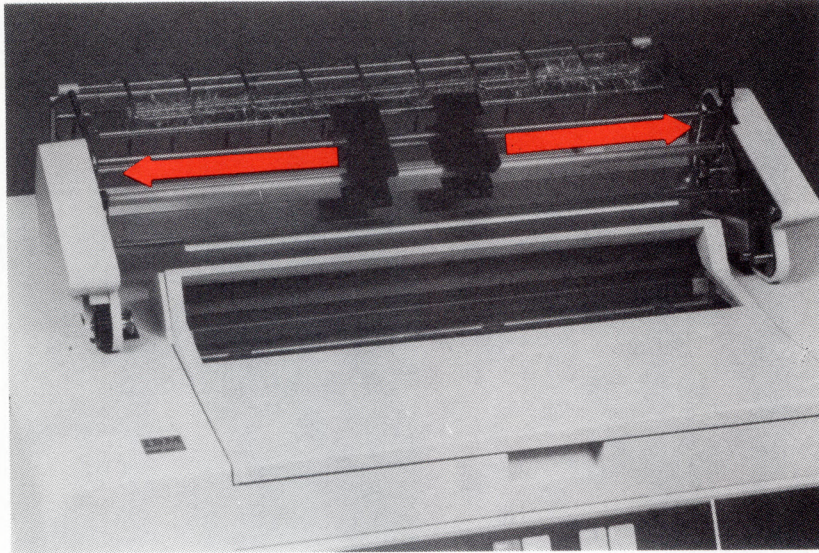

3. Move the left tractor to the extreme left and the right tractor to the extreme right.

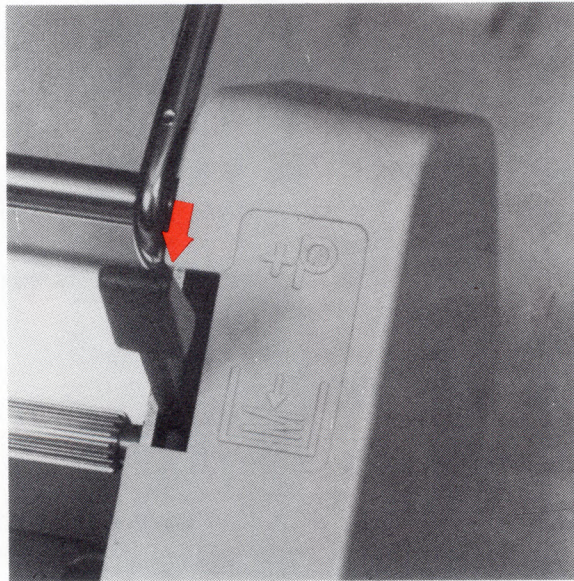

4. Move the tension bar lever to the Load () position.

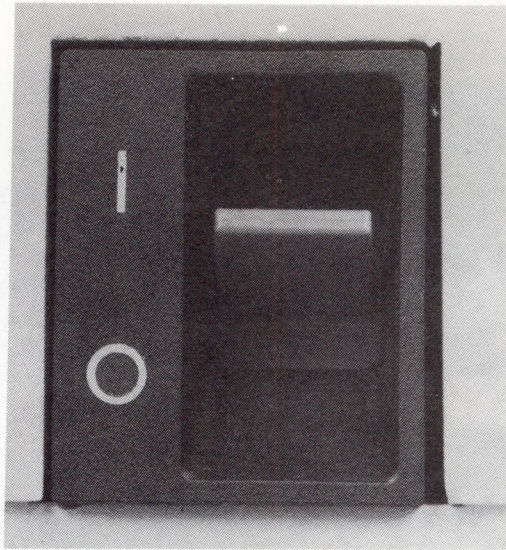

5. Turn the printer power ON ().

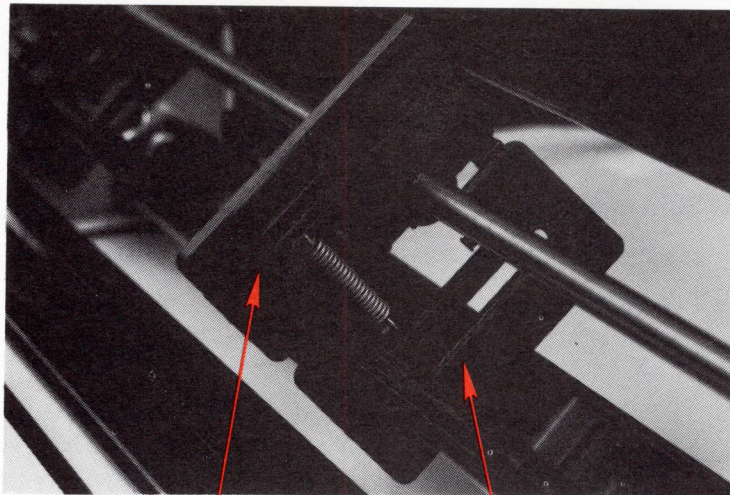

Front Tractor Lid

Rear Tractor Lid

6. Open both front and rear tractor lids on both the left and right tractors.

Note: Although multi-parts positive fastened forms will feed through the IBM tractor, 5- or 6-part forms may not load correctly using this method. If you are using 5- or 6-part forms, go to TRACTOR FEED LOADING with 5- and 6-PART FORMS in this chapter for an alternate method.

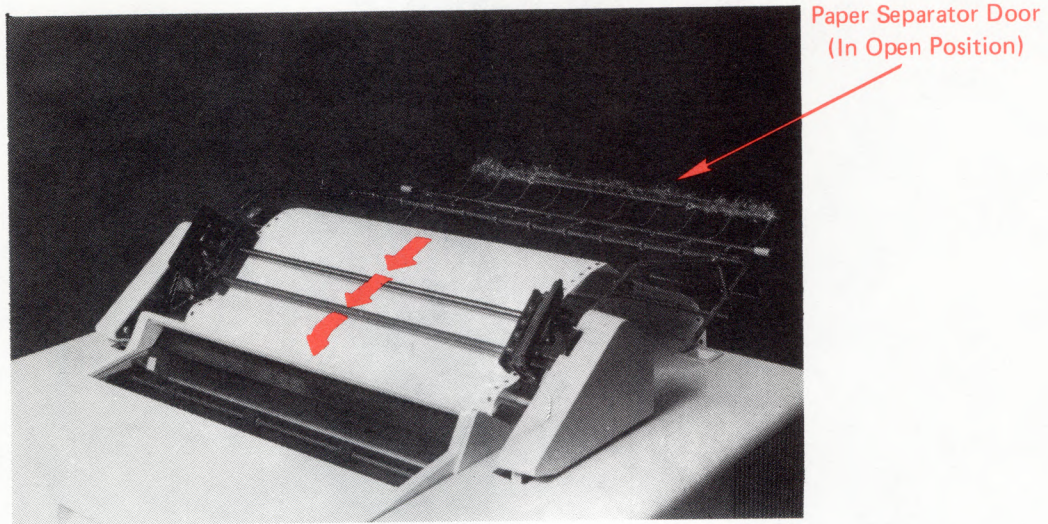

7. Bring the form up through the Paper Separator door.

Slide the form into the paper slot, as the arrows indicate.

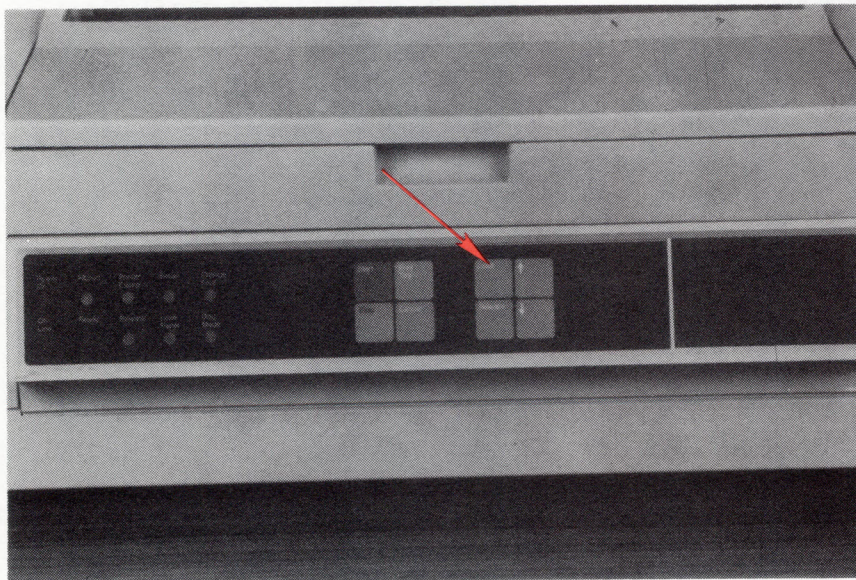

8. Lightly hold the continuous-form paper in place and press Load. The form will feed through the printer.

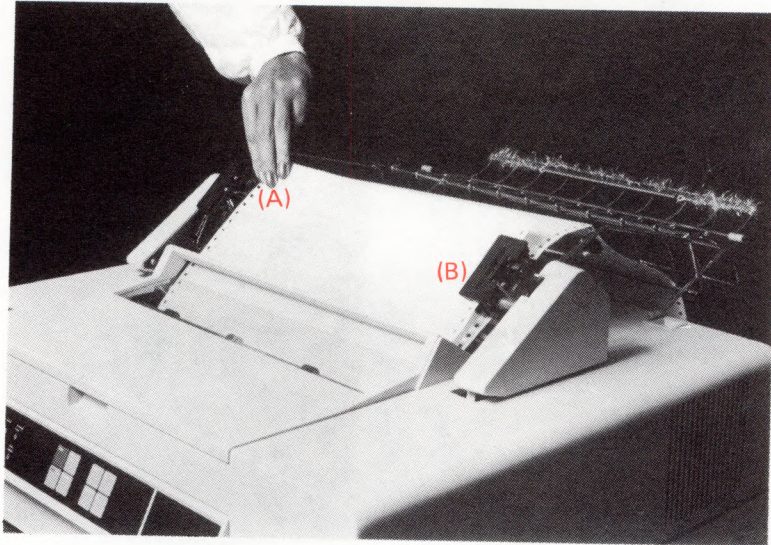

9. Slide the left tractor (A) toward the form so that the holes in the form can be placed on the pins of the front tractor.

Close the left front tractor lid.

10. Slide the right tractor (B) toward the form so that the holes in the form can be placed on the pins of the front tractor. Make sure the form is level.

Close the right tractor lid.

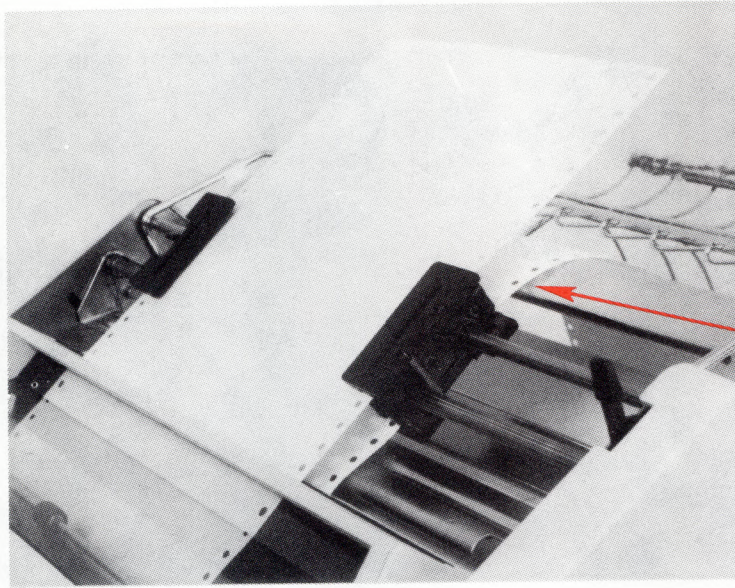

11. Gently pull on the back side of the forms to remove any excess slack. Place the form on the rear pins of both tractors and close both rear lids.

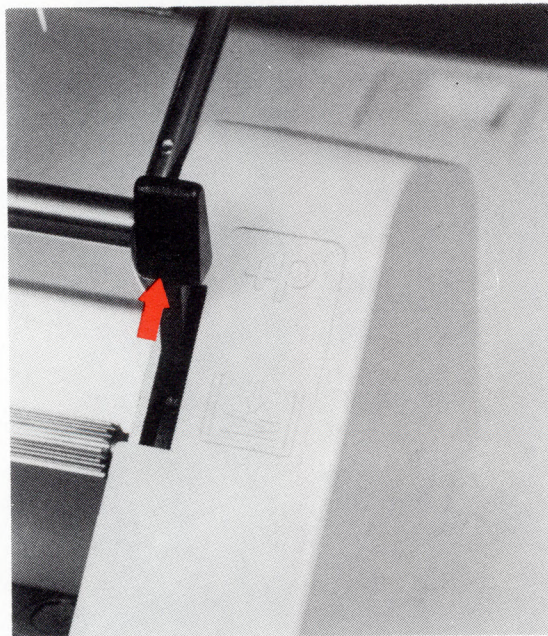

12. Move the tension bar lever to the print position (+P).

13. To make horizontal adjustments of the form, slide the left and right tractors to align the perforation of the form with the left v-notch. The left V notch on the card holder represents the first possible print position. If the Release light is off, press the Release button to open the paper bail, then adjust the paper. After completing the paper adjustment, press the Release button to close the paper bail.

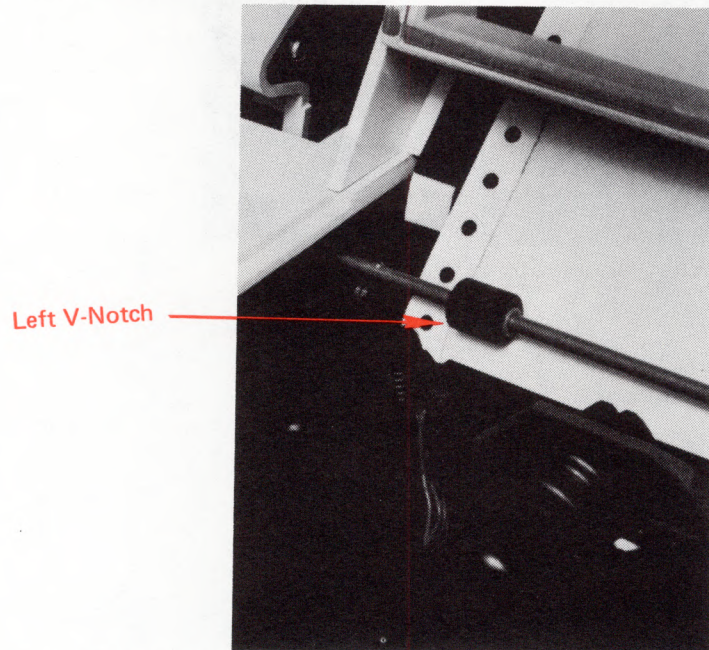

14. Lock the left tractor by pressing down on the latch (A).
- a. Adjust the right tractor so the form is flat and free of wrinkles.
 - b. Lock the right tractor by pressing down on the latch (B).

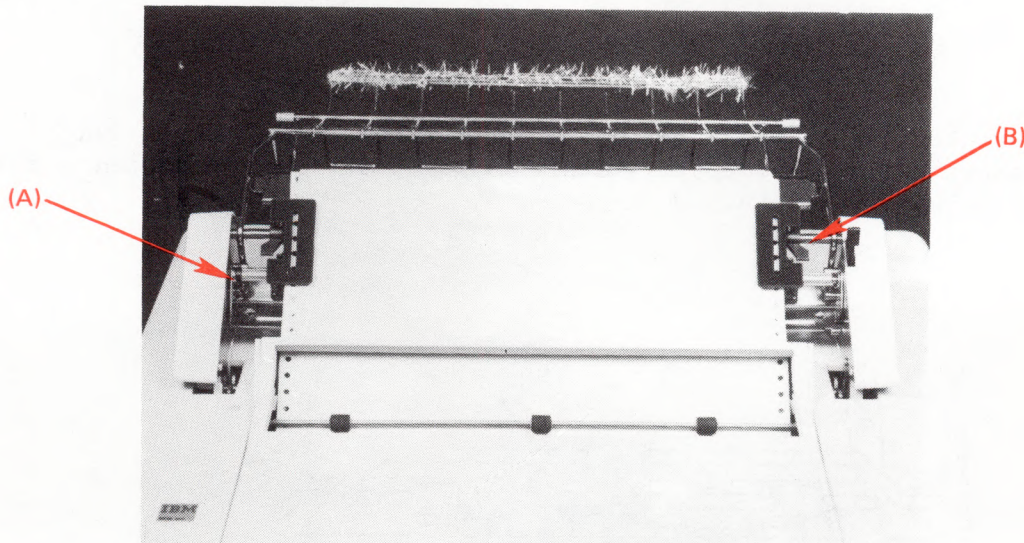

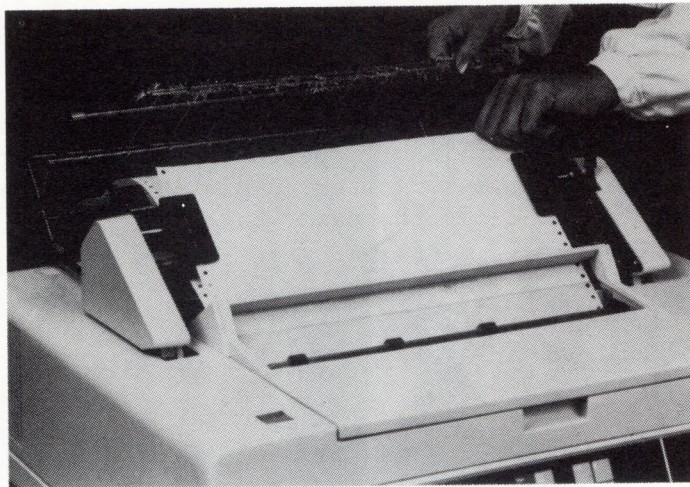

15. Lift the form and close the Paper Separator Door.

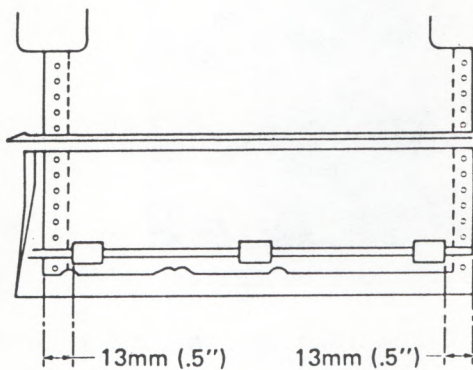

16. If your printer has a paper bail which looks like the one above, set the outside paper bail roller approximately 13 mm (0.5 inches) from where the edges of the paper will be.

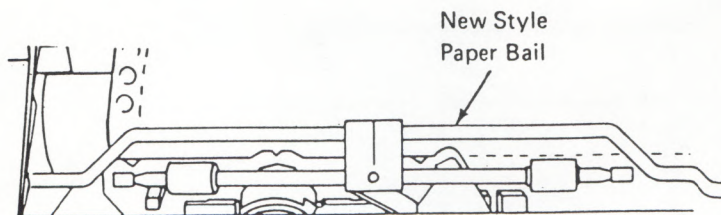

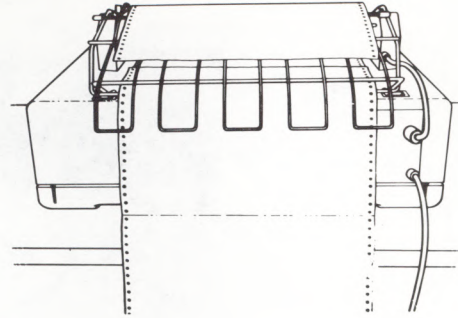
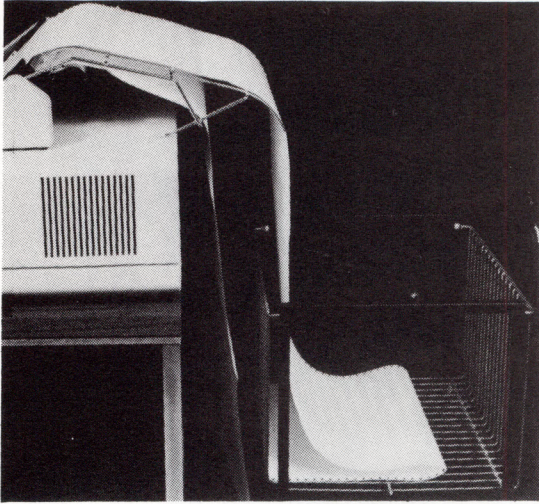

17. If you have a paper stand, place it behind the printer as shown so the paper can neatly fold into the stand after printing. The form should be loaded as shown.

Note: The paper stand may be used with forms equal to or less than 445 mm (17.5 inches) edge to edge. Form widths between 445 mm (17.5 inches) and 458 mm (18 inches) may be used if a wider paper stand is used. The input forms edge must be vertically straight when viewed from the rear. Tractor feed problems could result if the input forms supply is incorrectly positioned side to side.

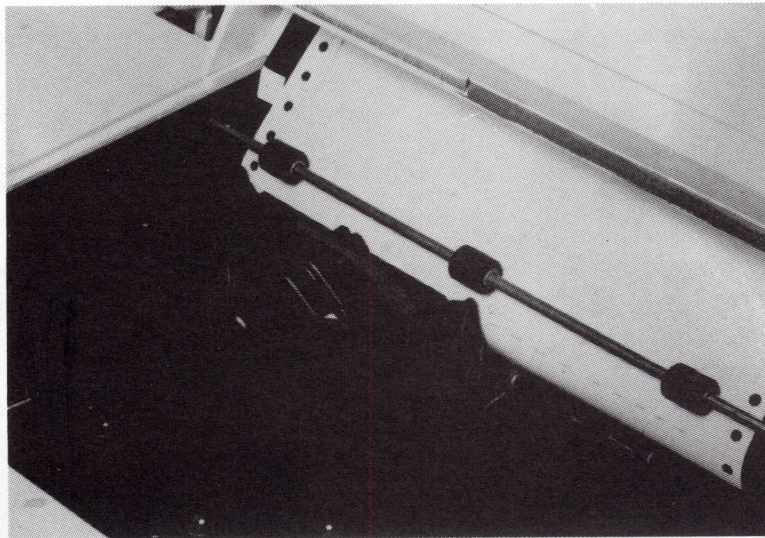

18. Align the perforation on the next form with the top of the card holder using the (↑) button. Should the form advance past the desired position, use the (↓) button to reverse past the desired position. Then use the (↑) button to advance to the desired position. The last operation before printing should be a (←) of at least one whole line. This will prevent a vertical alignment error.

UNLOADING PAPER FROM THE IBM TRACTOR FEED

Tear the incoming form at the nearest perforation before it enters the IBM Tractor Feed at the rear of the printer.

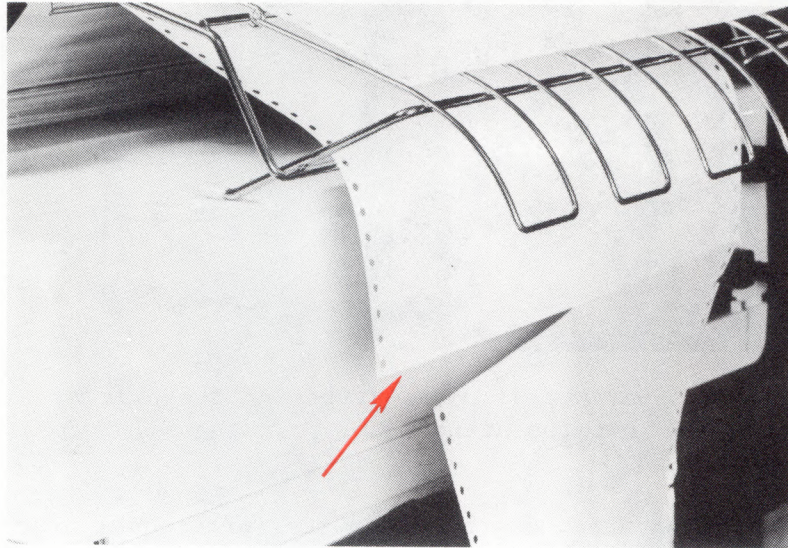

Press Load until the form leaves the printer and the front tractors. You may have to press Load more than once.

Remove the form.

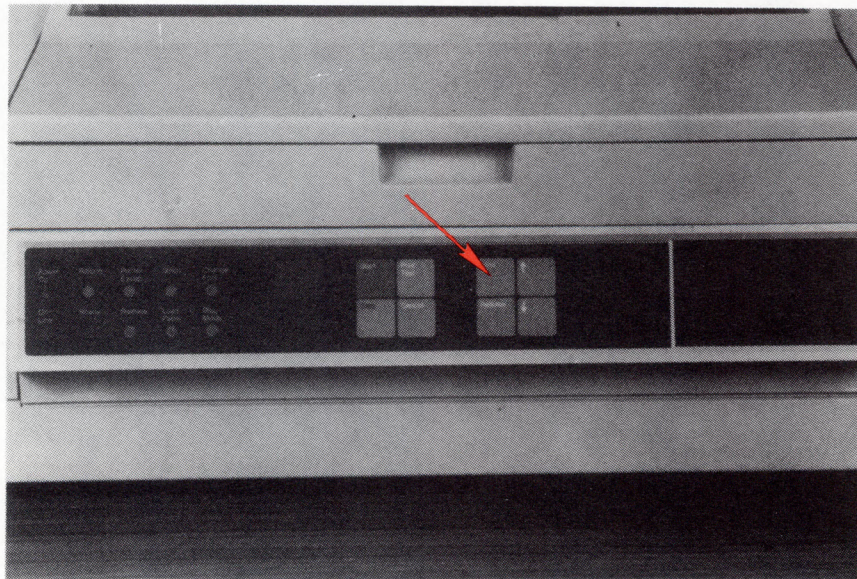

LOADING PAPER AND ENVELOPES MANUALLY WITH THE IBM TRACTOR FEED ATTACHED

You may need to feed a single sheet of paper or an envelope through the IBM 5218/5228 Printwheel Printer while the IBM Tractor Feed is attached. To do this, follow these instructions:

1. Unload the forms.
2. Turn the printer power OFF (O).
3. Press the thumb latch down or unplug the IBM Tractor Feed plug from the printer cable socket as shown above.

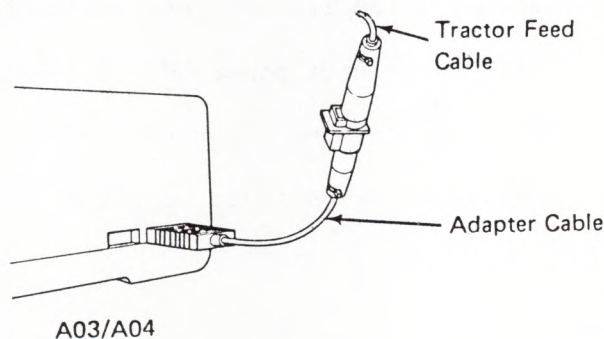
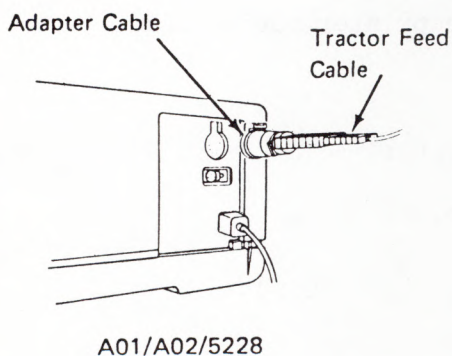
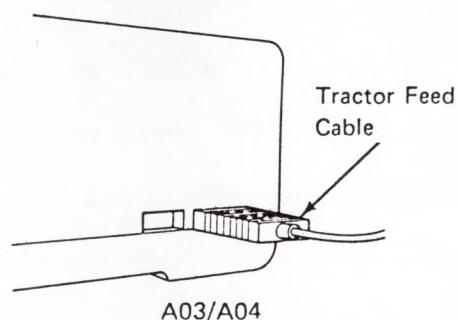
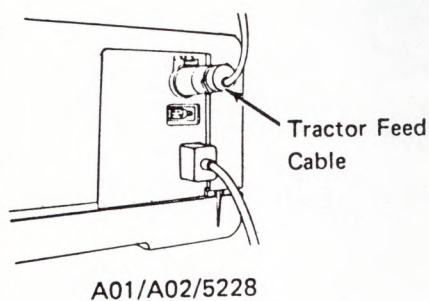

Note: If an adapter is required to attach the tractor feed, unplug the adapter cable from the rear of the printer.

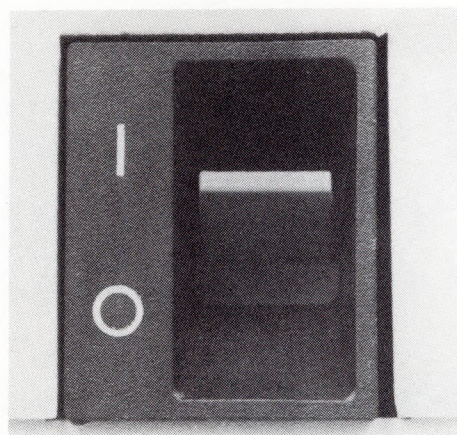

4. Turn the printer power ON (I).

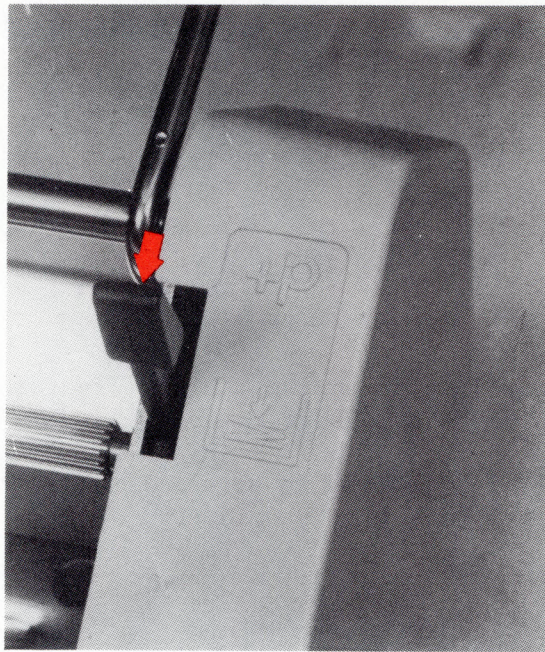



5. Move the tension bar lever to the Load () position.
6. Follow normal procedures for manual single sheet paper loading.
7. To return to Tractor Feeding:
 - Turn the printer power OFF (0).
 - Reconnect the Tractor Feed Cable plug to the printer cable socket.
 - Turn the printer power ON ().
 - Reload continuous paper as shown in this chapter.
 - Move the tension lever to the print position.

REMOVING THE IBM TRACTOR FEED FROM THE PRINTER

To remove the IBM Tractor Feed from the printer, follow these steps:

1. Unload continuous paper if installed. See Unloading Paper from the IBM Tractor Feed in this chapter. Close the paper separator door and close the tractor lids.
2. Turn the printer power switch OFF (O).

Press the thumb latch down or unplug the IBM Tractor Feed cable plug from the printer cable socket.

Note: If an adapter is required to attach the tractor feed, unplug the adapter cable from the rear of the printer.

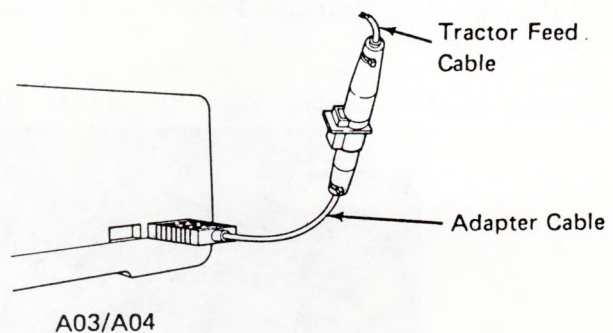
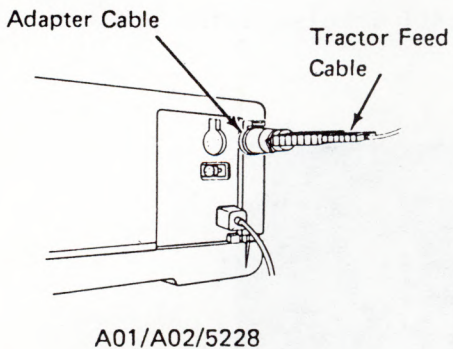
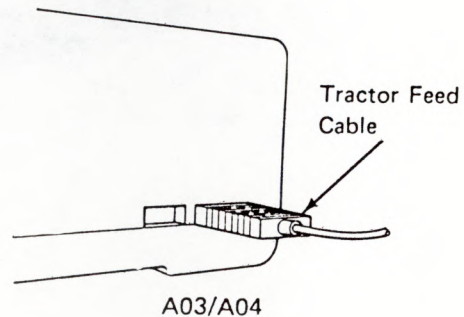
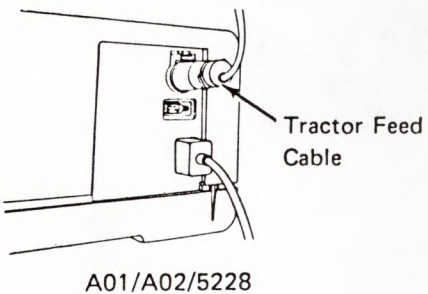

3. Lift the Paper Separator forward until it clears the IBM Tractor Feed.

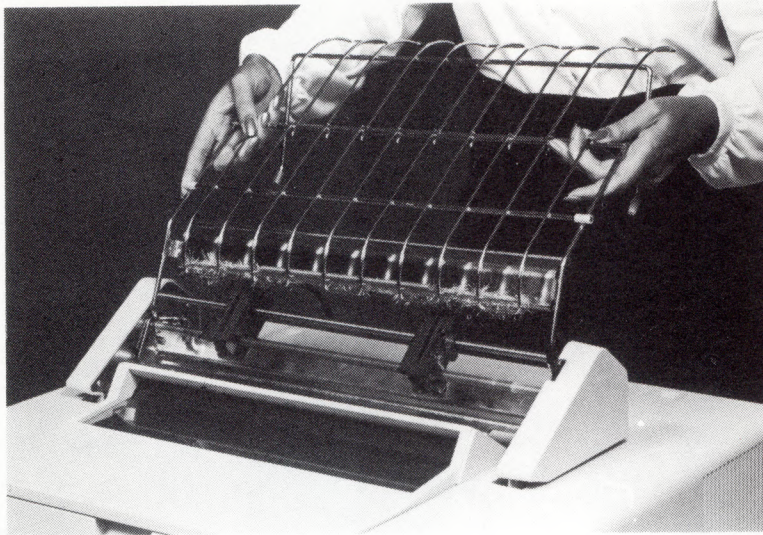

4. Rotate the IBM Tractor Feed forward and lift until it clears the printer cover.

Store the IBM Tractor Feed in a safe place.

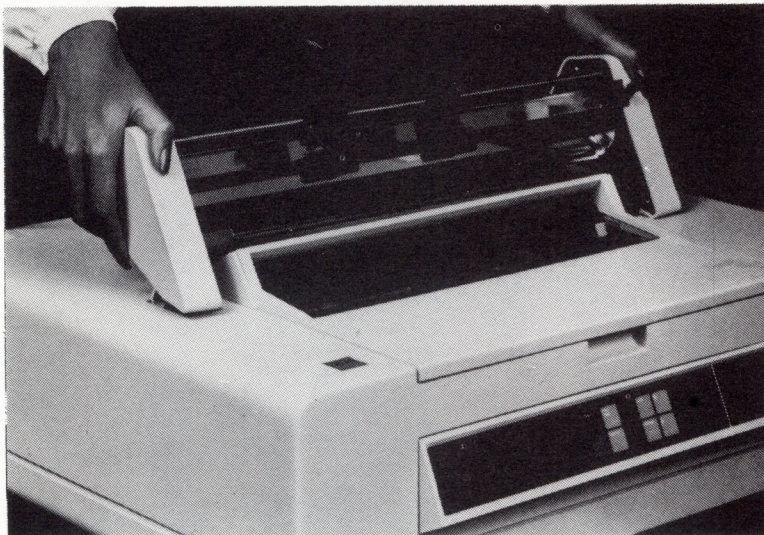

TRACTOR FEED LOADING WITH 5 AND 6 PART FORMS

1. The tractors must be set for the forms width. Move the left tractor to the approximate position for the left paper edge. Place the holes in the form on the front pins of the left tractor.

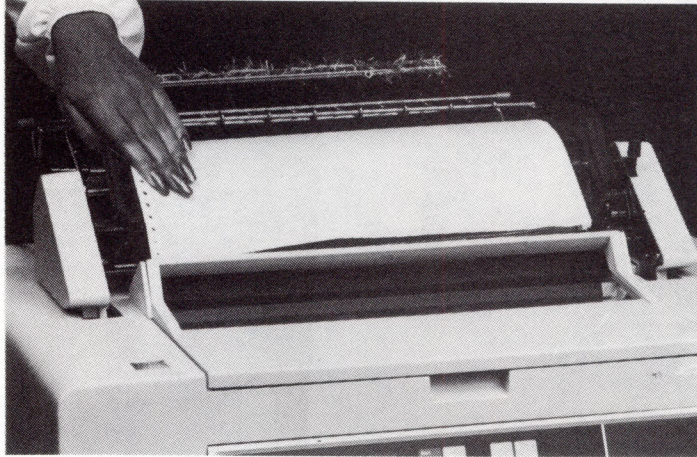

2. Close the left tractor lid.

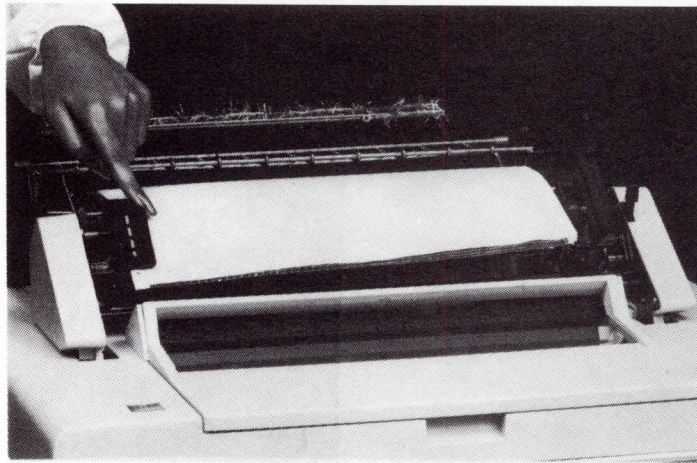

3. Lock the left tractor in place.

Press Down
to Lock

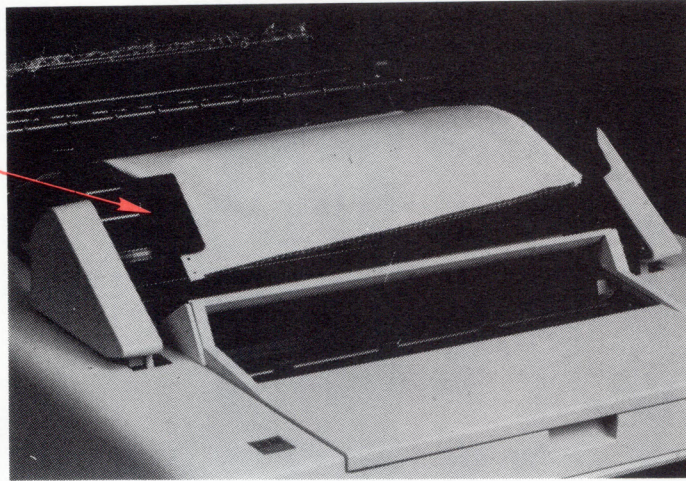

4. Move the right tractor toward the form and place the holes in the form on the pins of the right tractor.

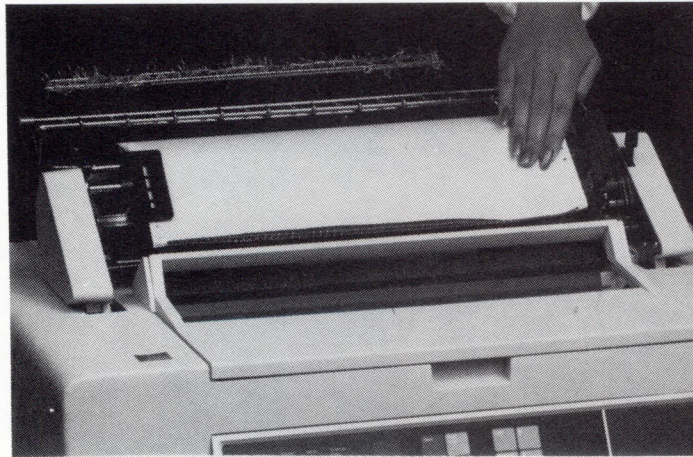

5. Close the right tractor lid.

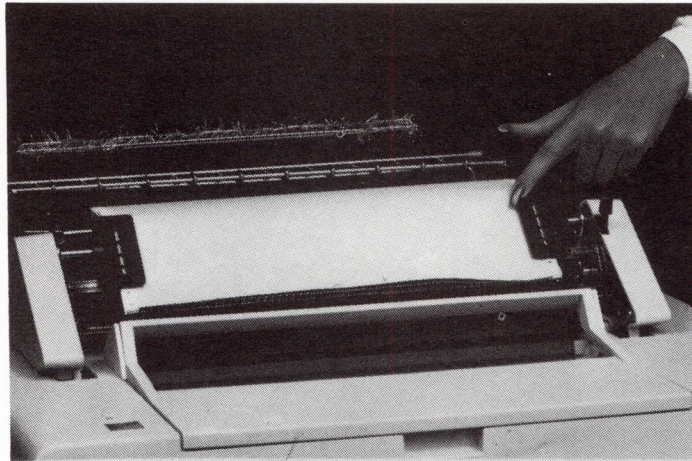

6. Lock the right tractor in place.

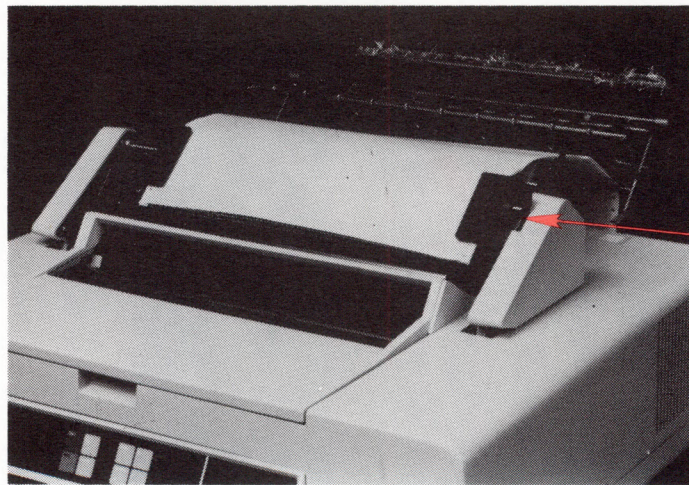

Press Down
to Lock

7. The tractors are now set to the proper width for the form to be loaded. Open both tractor lids and remove the form.

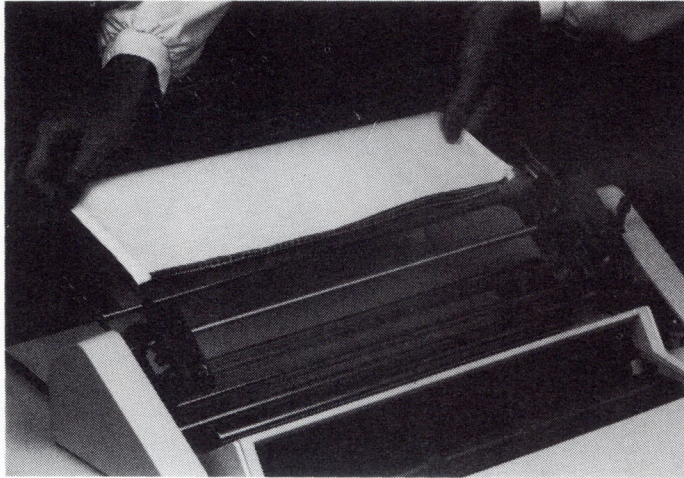

8. Bring the form up through the Paper Separator Door.

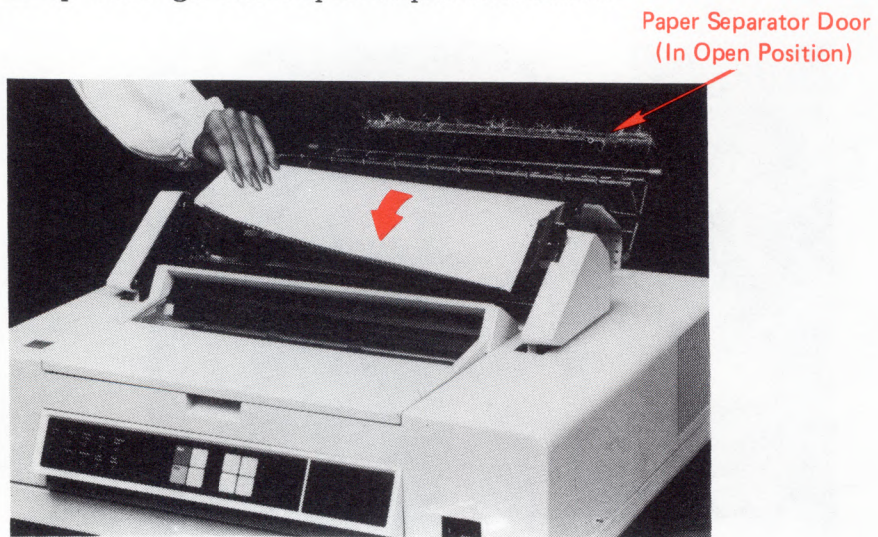

9. Place the form on the rear tractor pins and close the rear tractor lids.

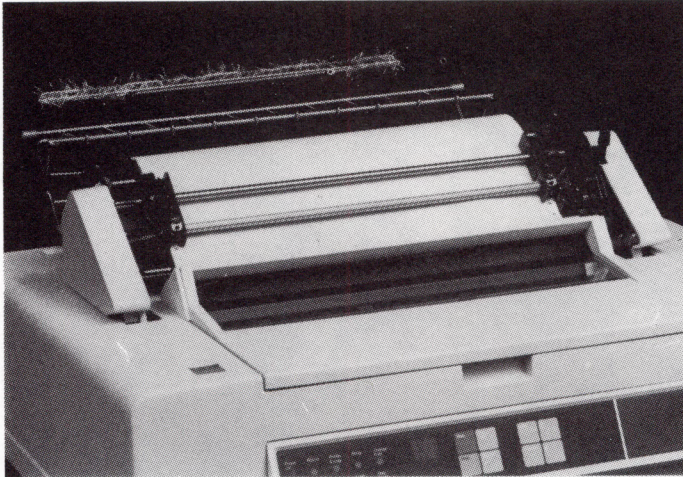

10. Using the (↑) button, index the form down into the paper slot until a small bulge forms as shown below.

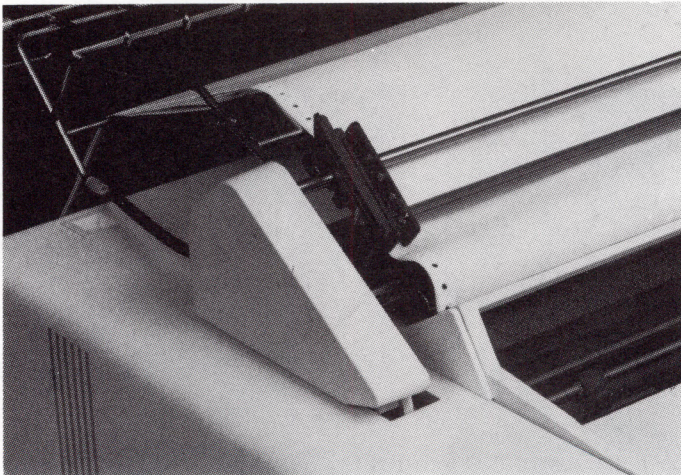

11. Press the Load button. The form will feed around the platen and up to the front tractors. Pull up gently on the leading edge of the form and place the holes in the form on the left front tractor pins and close the left front tractor lid.

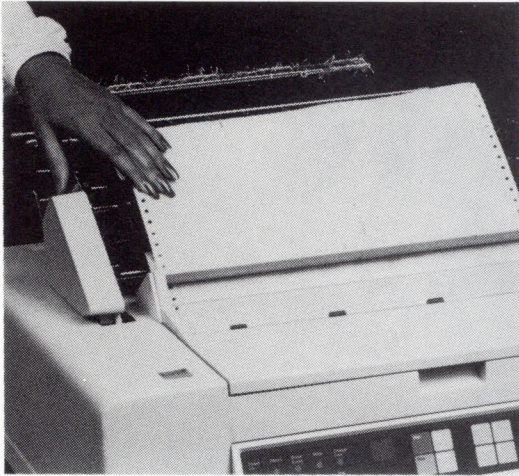

12. Place the holes in the form on the right front tractor pins and close the right front tractor lid.

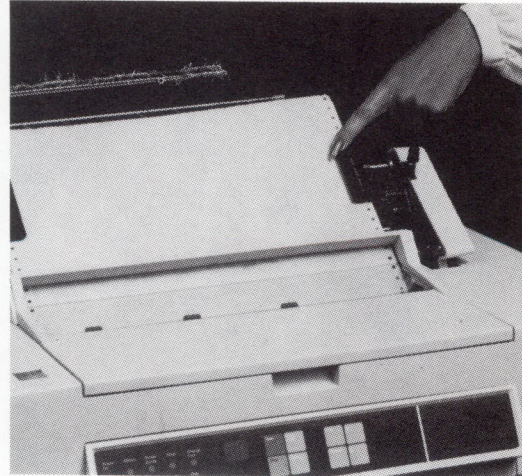
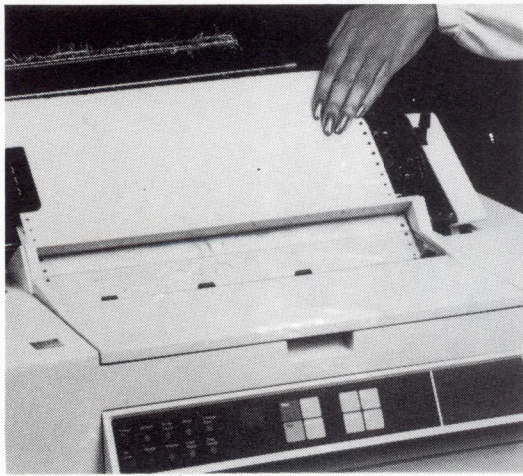

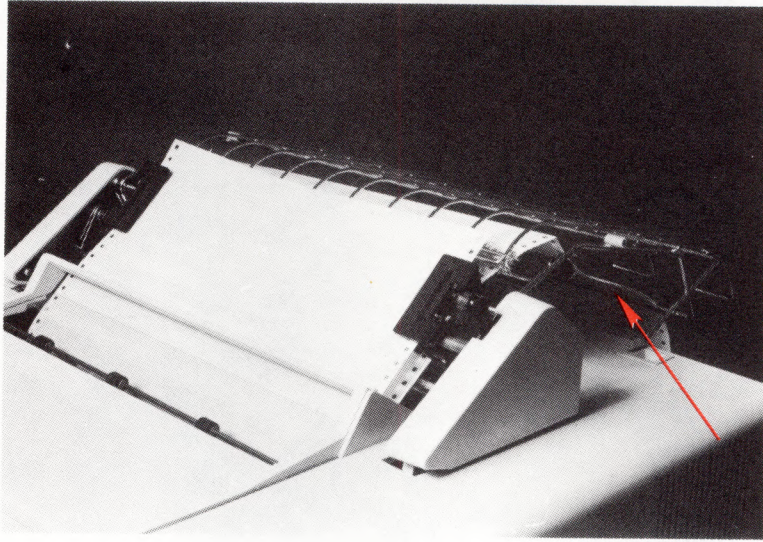

13. Gently pull on the back side of the forms to remove any excess slack.

14. Move the tension lever to the print position (+P).

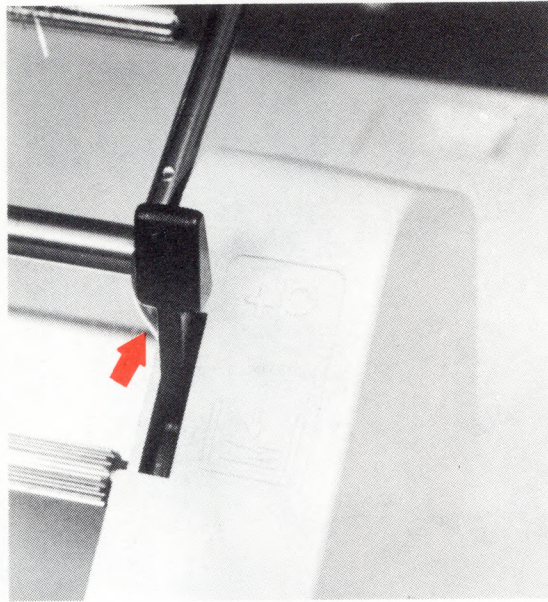

15. Lift the form and close the paper separator door.

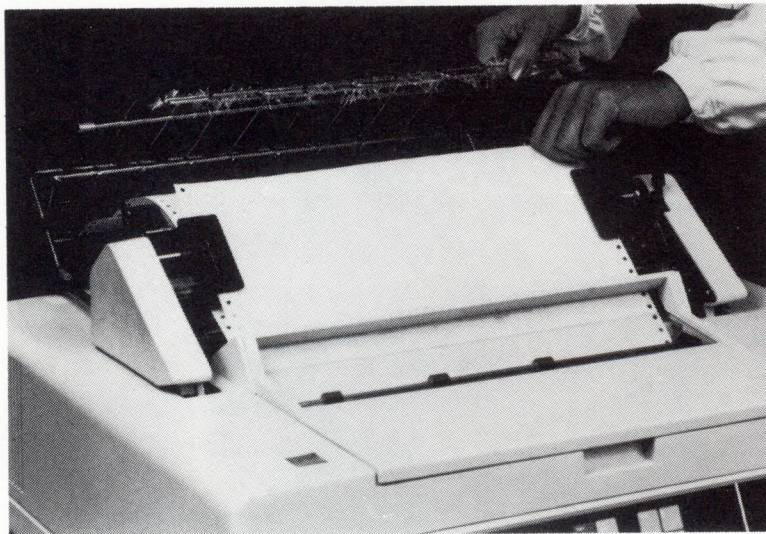

16. Set the outside paper bail rollers approximately 12.7 mm (0.5 inches) from the paper edges, and center the third roller on the page.

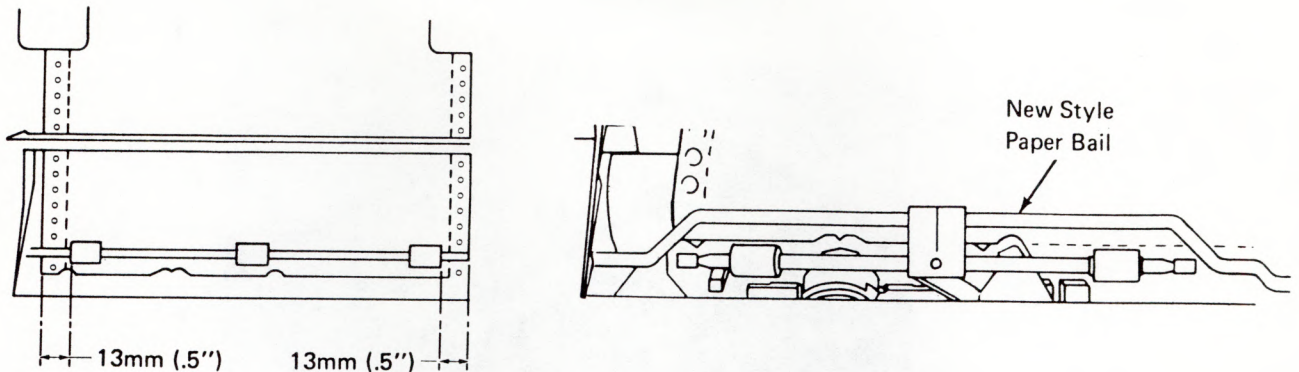

17. If you have a paper stand, place it behind the printer as shown so the paper can neatly fold into the stand after printing. The forms should be loaded as shown.

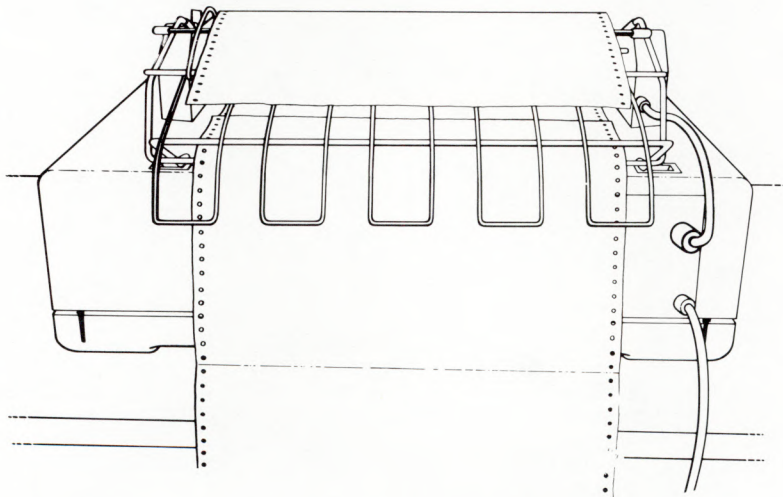

Note: The paper stand may be used with forms equal to or less than 445 mm (17.5 inches) edge to edge. Forms widths between 445 mm (17.5 inches) and 458 mm (18 inches) may be used if a wider paper stand is used. The input forms edge must be vertically straight when viewed from the rear. Tractor feed problems could result if the input forms supply is incorrectly positioned side to side.

18. Align the perforation on the next form with the top of the card holder using the (↑) button. Should the form advance past the desired position, use the (↓) button to reverse past the desired position. Then use the (↑) button to advance to the desired position. The last operation before printing should be a (↑) of at least one whole line. This will prevent a vertical alignment error.

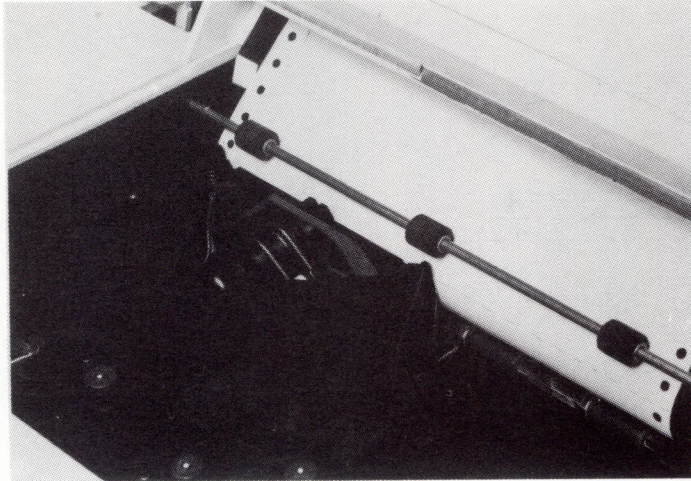

CHAPTER 11. IBM SHEET-FEED PAPER HANDLER

The IBM Sheet-Feed Paper Handler is an automatic paper handling device available for the IBM 5218/IBM 5228 Printwheel Printer. The paper handler has two input paper trays each of which holds approximately 200 cut sheets of 20-pound paper. The output tray will hold approximately 400 sheets of 20-pound paper.

Note: Read the Paper Specifications and Environmental Conditions described in "Appendix G".

INSTALLATION OF THE IBM SHEET-FEED PAPER HANDLER

To install the IBM Sheet-Feed Paper Handler, follow these instructions:

Note: Because the IBM Sheet-Feed Paper Handler weighs approximately 12 kg (26.4 pounds), two people are recommended to install it.

- Turn the printer power OFF (O). Remove the Paper Support Table (Chapter 9) or IBM Tractor Feed (Chapter 10) if installed.

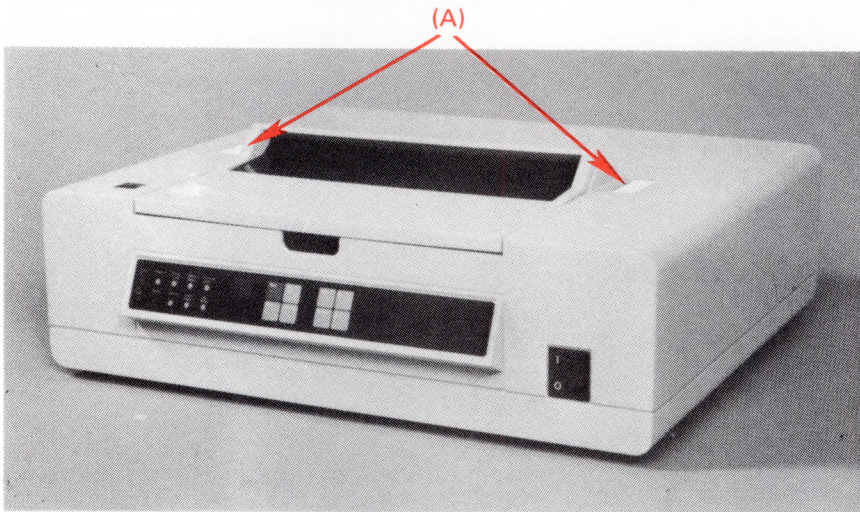

Remove the cover inserts if they are in place (A).

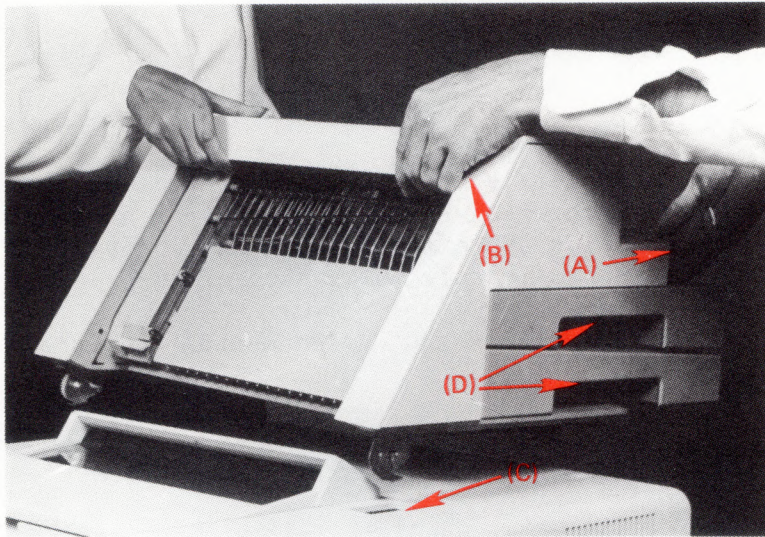

With a person on each side of the IBM Sheet-Feed Paper Handler, facing each other, place hands in the hand scoops (A) and on the front edges (B) of the cover to place the device level on top of the printer.

Insert the latches through the printer cover openings (C).

Note: Do not lift the paper tray handles (D).

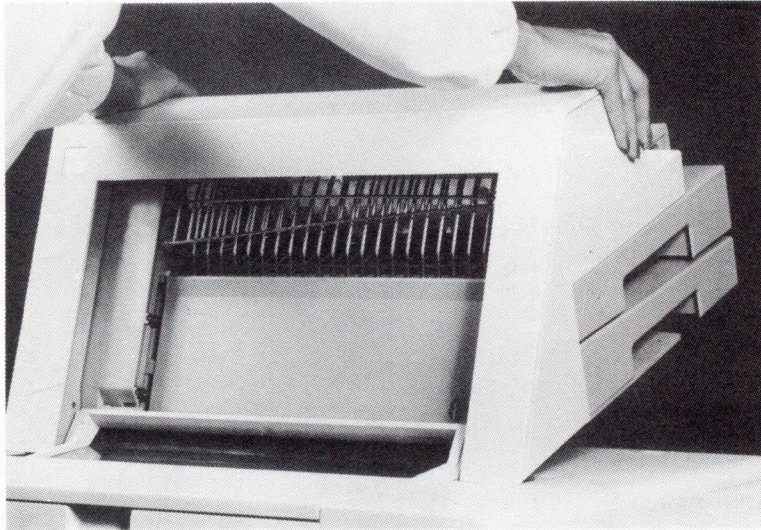

With one person standing in front of the printer, tilt and pull forward on the Sheet-Feed Paper Handler approximately 75 to 100 mm (3 to 4 inches) until the latches click into position.

Slowly lower the rear of the device until it rests on the printer cover.

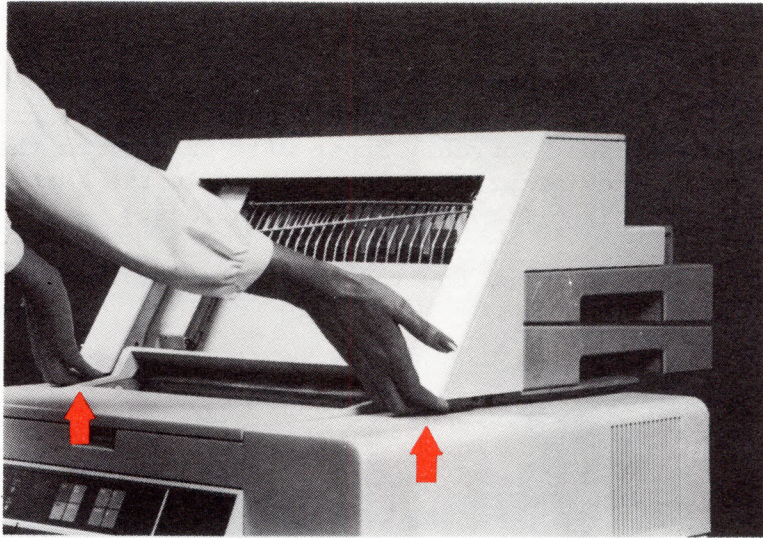

To make sure the Sheet-Feed Paper Handler is installed correctly, try to lift the device at both front corners. If the Sheet-Feed Paper Handler lifts away from the printer, return to the previous steps.

Make sure the power is OFF (O).

Connect the IBM Sheet-Feed Paper Handler cable plug into the printer cable socket.

Note: To connect the Sheet Feed Paper Handler to the A03 or A04 models, an adapter cable is required.

Turn printer power ON (I).

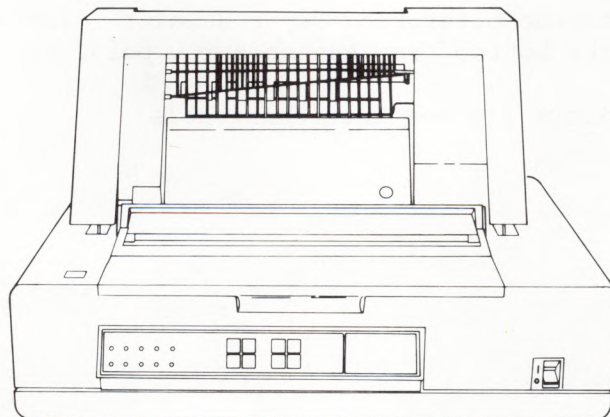

Sheet-Feed Paper Handler used on the IBM 5228 Printer. Installation and removal procedures are the same as for the IBM 5218 Printer Sheet-Feed Paper Handler.

LOADING PAPER INTO THE IBM SHEET-FEED PAPER HANDLER

The IBM Displaywriter will allow you to choose which paper tray you will print from. When the PAGE FORMAT menu appears on the screen, make the proper selection for your printing paper source. Paper will print from that tray until another selection is made. Review printing procedures in the Work Station Procedures Guide. (See Appendix G for paper specifications.)

To load paper into the IBM Sheet-Feed Paper Handler, follow the steps and illustrations below:

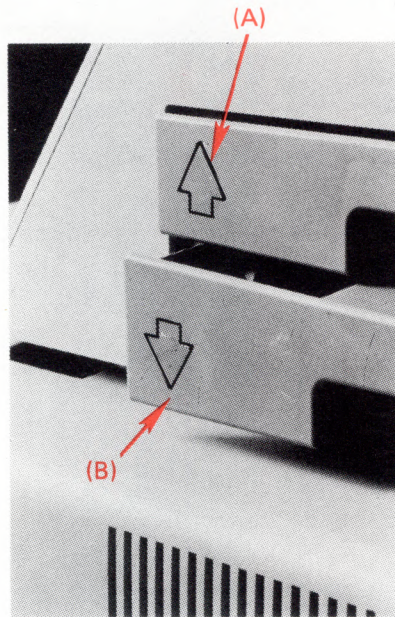

There are two paper trays on the Sheet-Feed Paper Handler. The top tray has an arrow pointing up (A) and the bottom tray has an arrow pointing down (B).

Note: The top and bottom trays are not interchangeable.

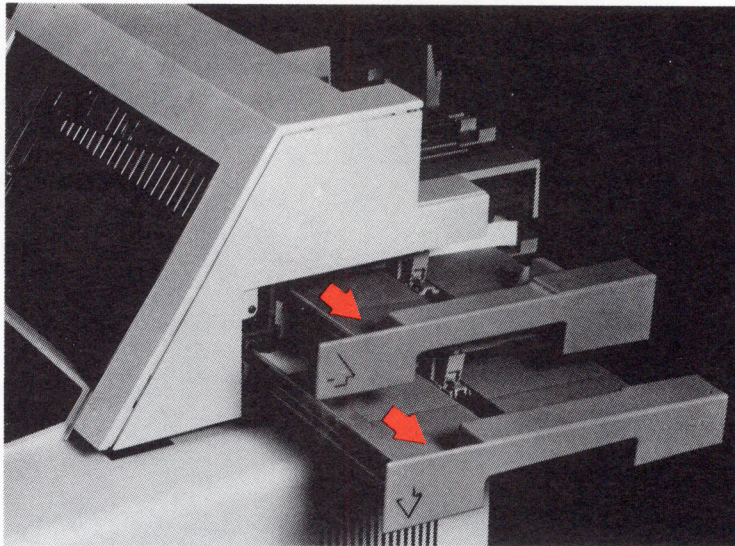

Pull the paper trays out by sliding them to the right side of the IBM Sheet-Feed Paper Handler.

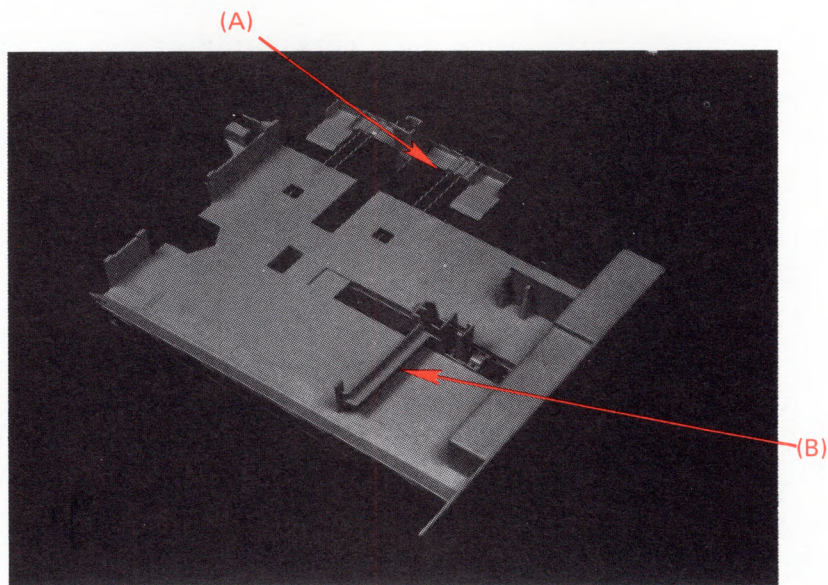

Slide the rear extender (A) and the paper edge guide (B) out to fit the paper length and width.

Fan the paper.

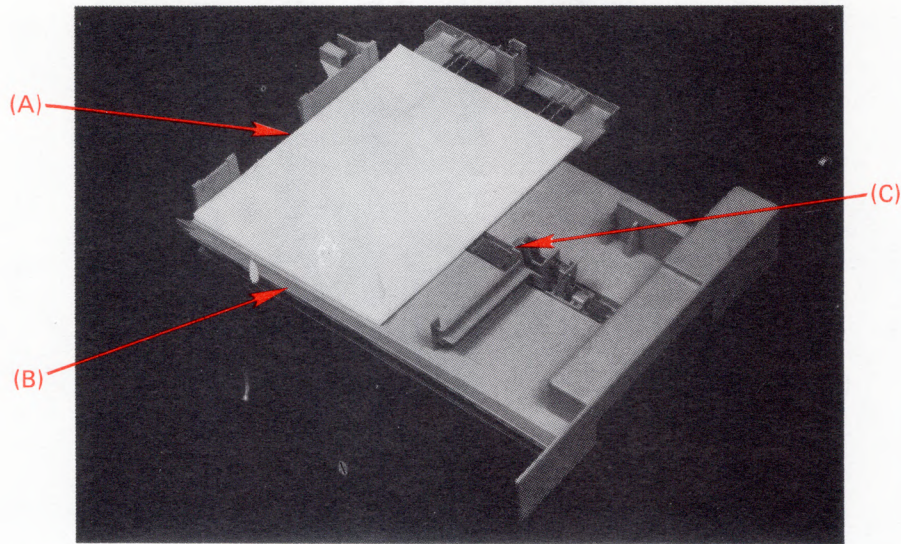

Insert the paper so that:

- The side of paper to be printed is faced down.
- The paper stack is flush against the left edge guide of the paper tray (A).
- The top edge of the paper stack lies on the load paper line at the front of the paper tray (B).

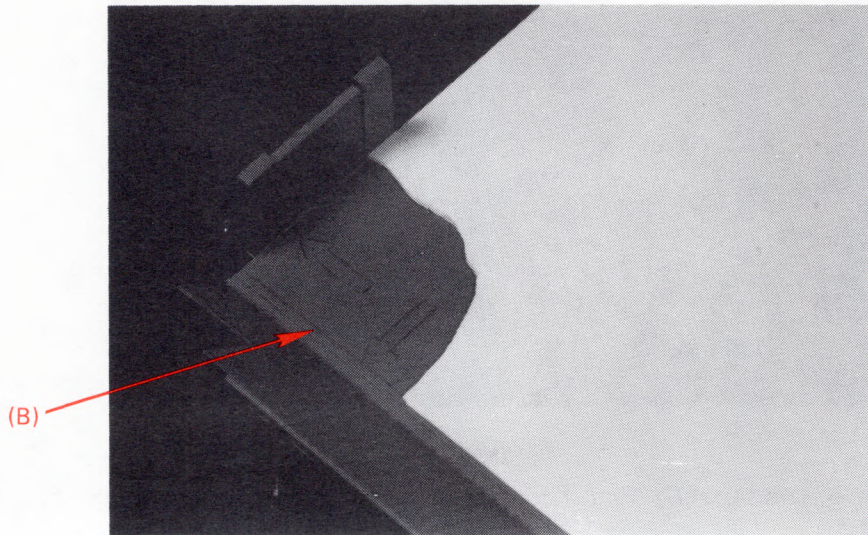

Note: The paper stack cannot exceed 28 mm (1.1 inches) which is approximately 200 sheets of 20 pound bond paper. The tab (C) on the paper edge guide indicates the maximum allowable paper height.

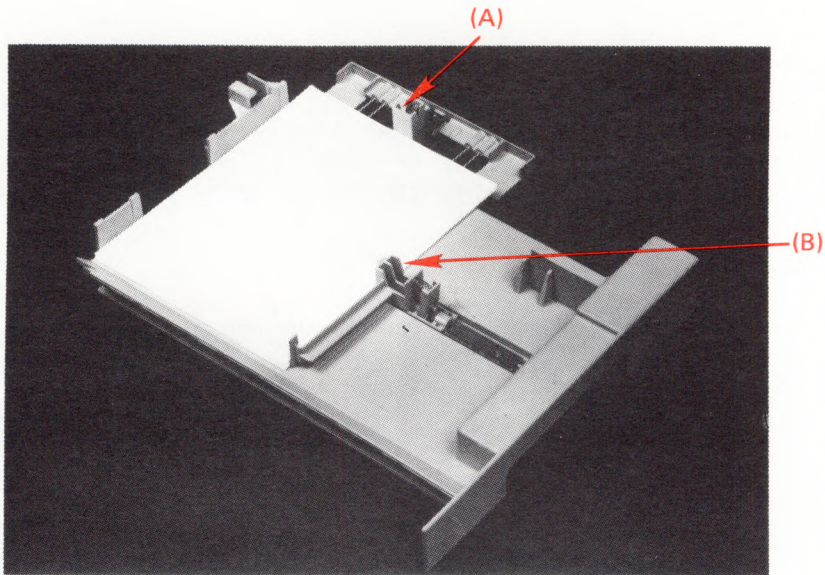

Slide the rear paper guide up (A) loosely against the rear edge of the paper stack.

Slide the paper edge guide (B) up loosely against the edge of the paper stack.

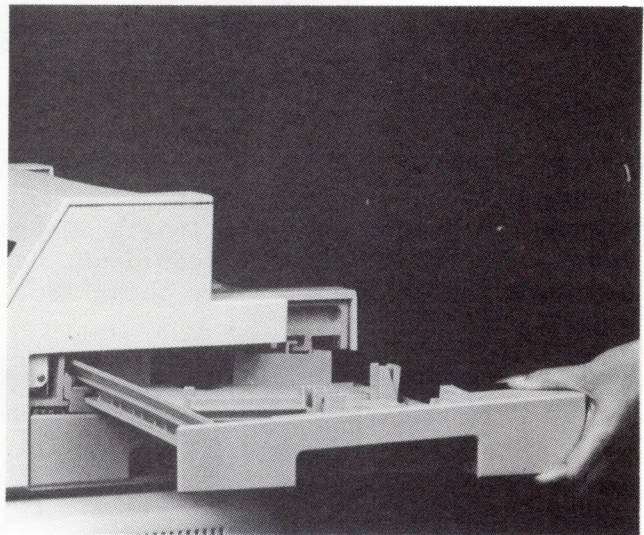
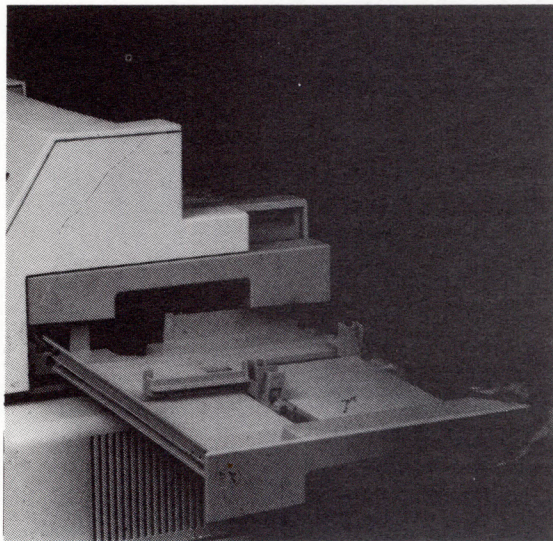

Slide the paper tray into the device until the tray clicks into position. Make sure that the tray rails fit over the device rails.

Lift the plastic strip in the Exit tray.

Place a sheet of paper in the exit tray that is the same size and direction as the paper in the paper tray. The front edge of the paper must be against the metal fence (A). Slide the paper guide (B) up to but not touching the rear edge of the paper.

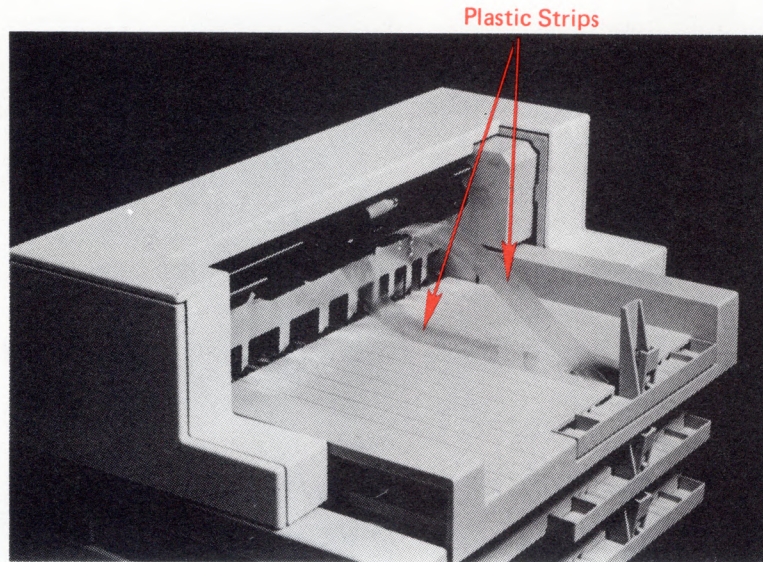

Note: If paper of different lengths is loaded, the rear edge guide must be set to accommodate the longest paper. If the rear edge guide will not slide back far enough to accommodate the length of paper being fed, pull back the rear extender. The rear extender should not be pulled any farther than necessary to accommodate the length of paper being fed.

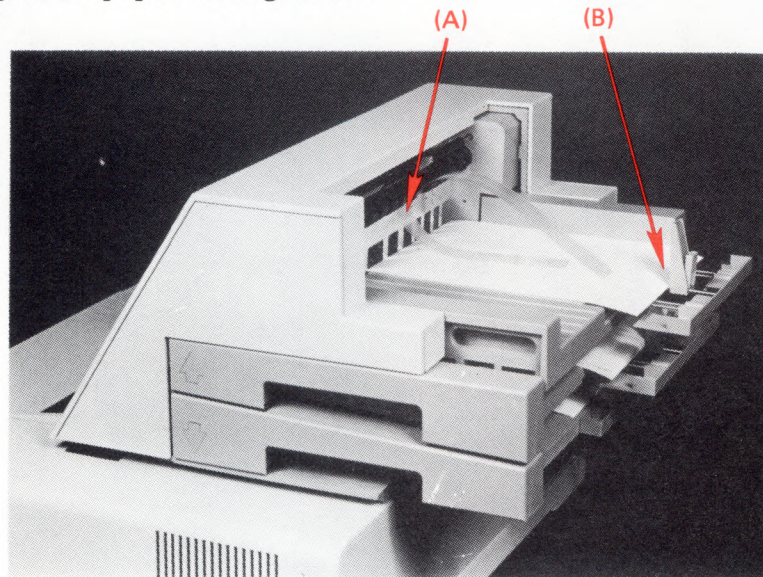

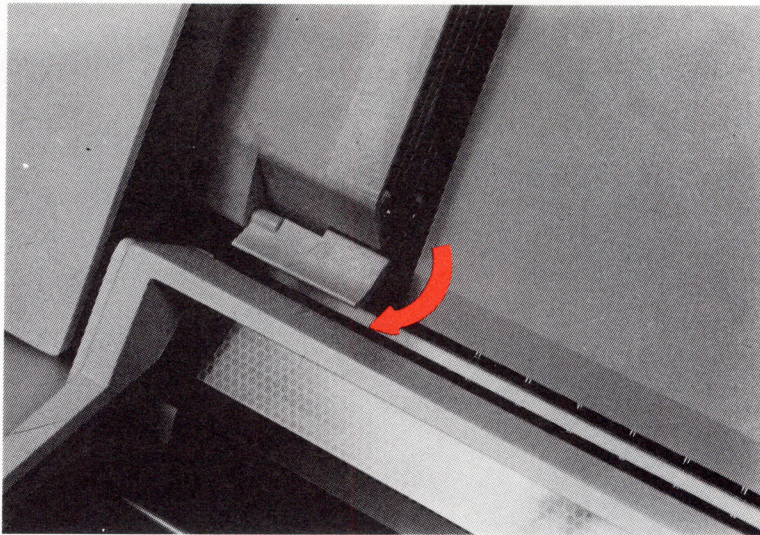

When ready to print, make sure the cut sheet paper insertion gate is in the position shown.

INSERTING CUT SHEET PAPER OR ENVELOPES MANUALLY WITH THE IBM SHEET-FEED PAPER HANDLER ATTACHED

You may need to feed a cut sheet of paper or an envelope through the IBM 5218/IBM 5228 Printwheel Printer while the IBM Sheet-Feed Paper Handler is attached. To do this, follow these instructions:

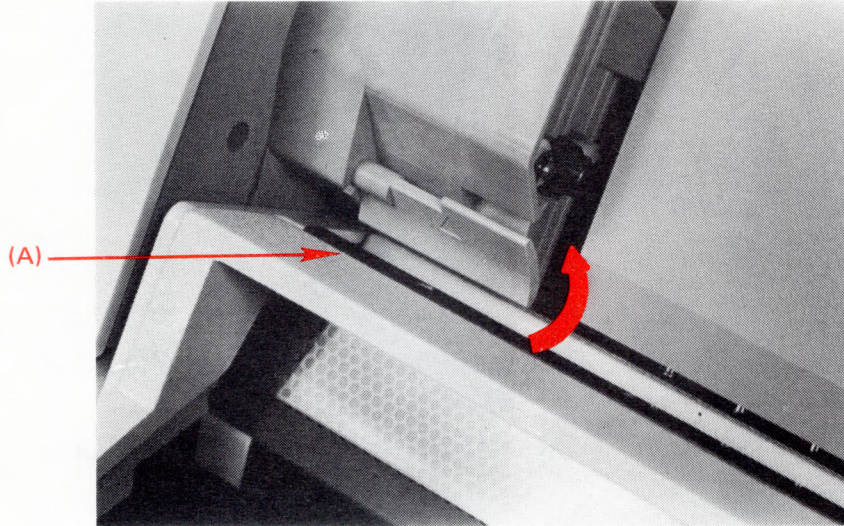

Rotate the paper insertion gate to the manual feed position as shown.

Place the paper behind the paper insertion gate and into the opening in the printer cover (A).

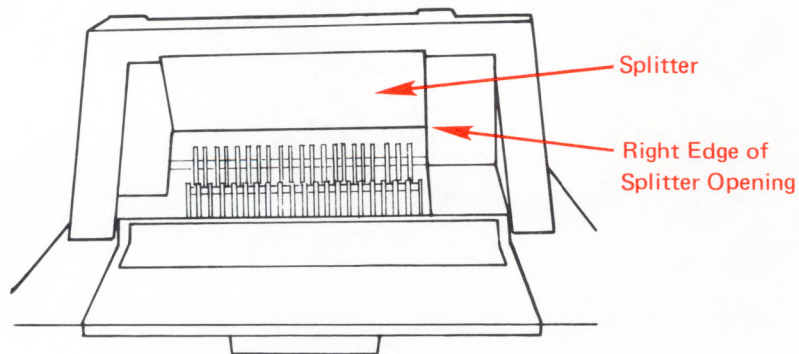

Note: On the IBM 5228 Printer, the splitter should be raised into the vertical position for paper extending beyond the right edge of the splitter opening.

The splitter and the paper insertion gate must be manually returned to their original positions for automatic operation.

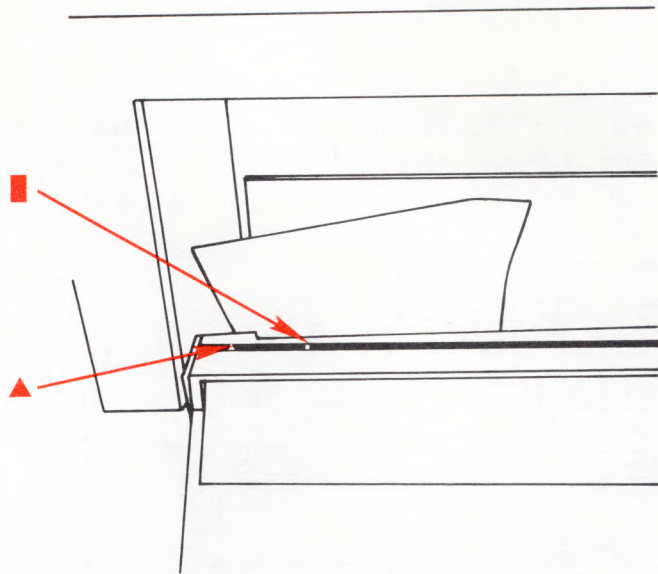

Locate the ▲ and ■ marks on the top of the printer. Align the left edge of the paper with the ▲ on the top of the printer. If the paper width is less than 150 mm (6 inches), use the ■ to align the left edge of the paper. On the IBM 5228 Printer, when using paper widths of 18 or 19 inches, the left edge of the paper should be aligned with the appropriate ■ to the left of the ▲ (See the illustration at the beginning of Chapter 9.)

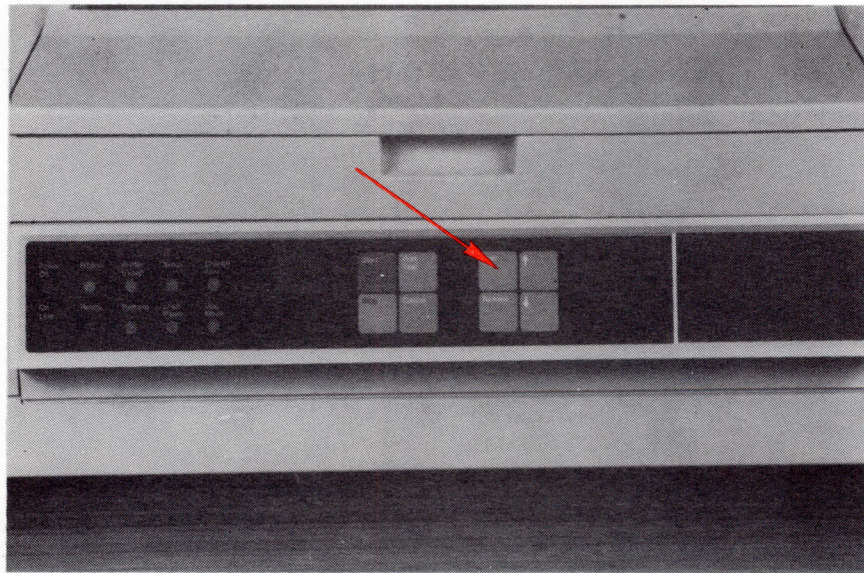

Press Load. The leading edge of the paper will be positioned at the top of the cardholder.

When printing is complete, rotate the paper insertion gate to the automatic feed position.

CLEARING PAPER MISFEEDS FROM THE SHEET-FEED PAPER HANDLER

Output Paper Path Jam

When paper is jammed in the path, a message appears on the display screen telling you to remove the paper jam and start the printer.

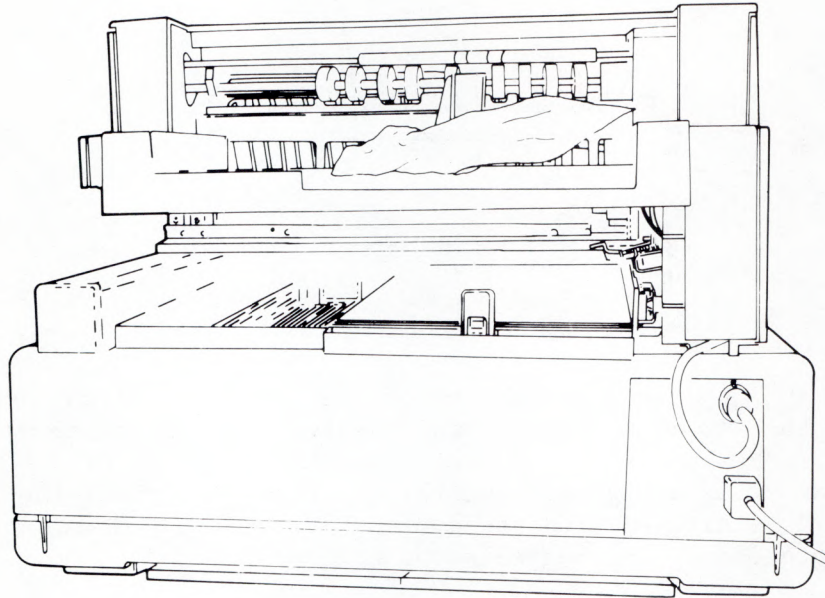

Remove paper jammed in the output paper path by pulling the paper out of the paper path.

Input Paper Path Jam

Remove paper jammed in the input path using the following procedures:

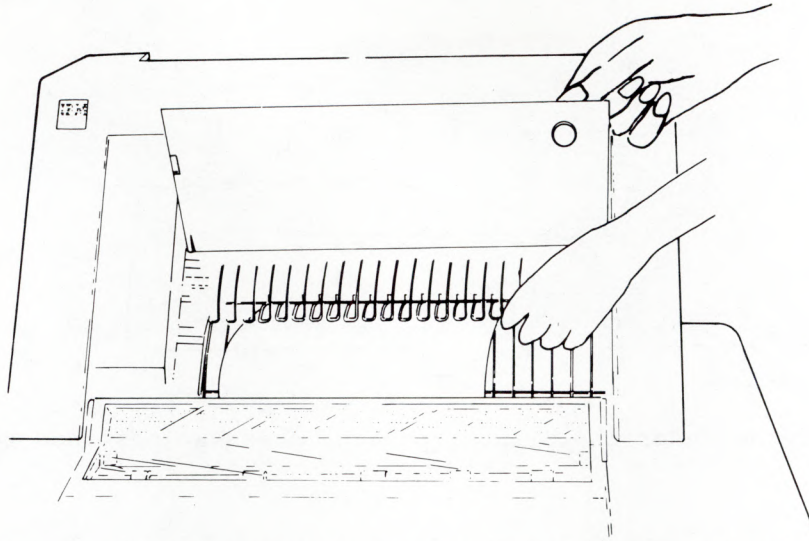

Lift the splitter. If the paper protrudes from the input paper path far enough, remove the paper by pulling it out of the paper path.

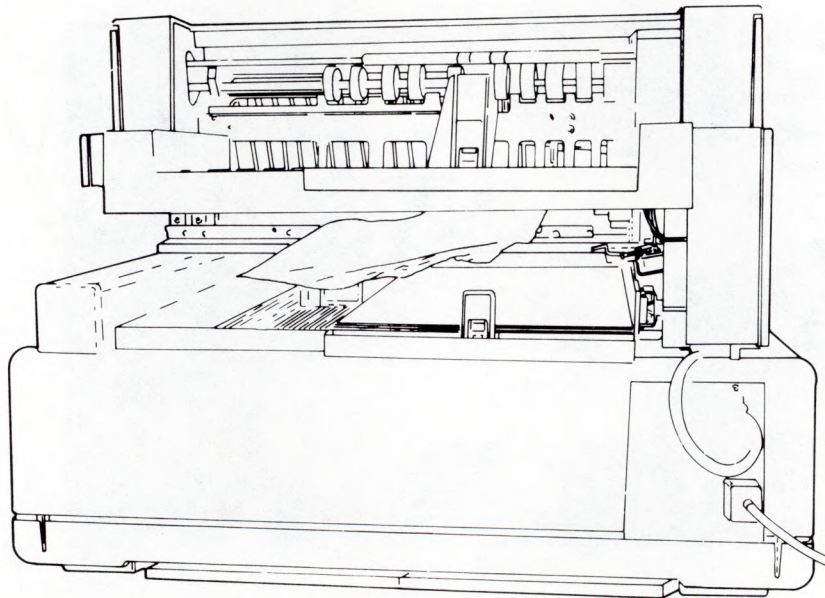

If the paper cannot be pulled out, pull the paper tray out and remove the jammed sheet. Re-align the paper in the paper tray and replace the paper tray.

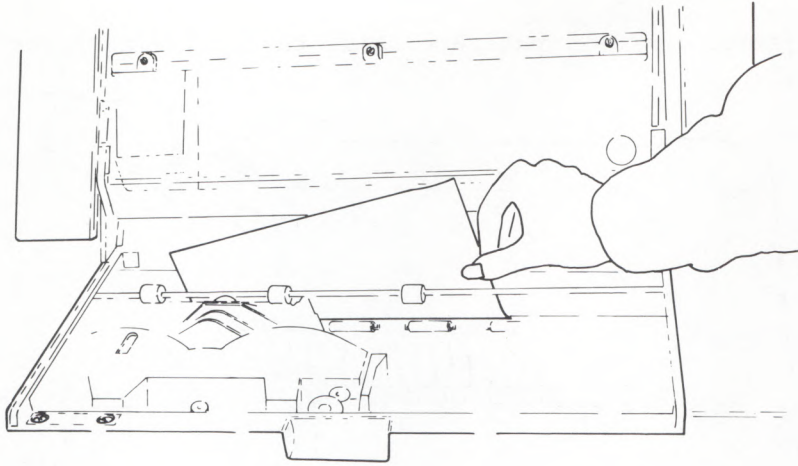

If the paper is jammed under the printer platen, press Release and remove the paper.

REMOVING THE SHEET-FEED PAPER HANDLER

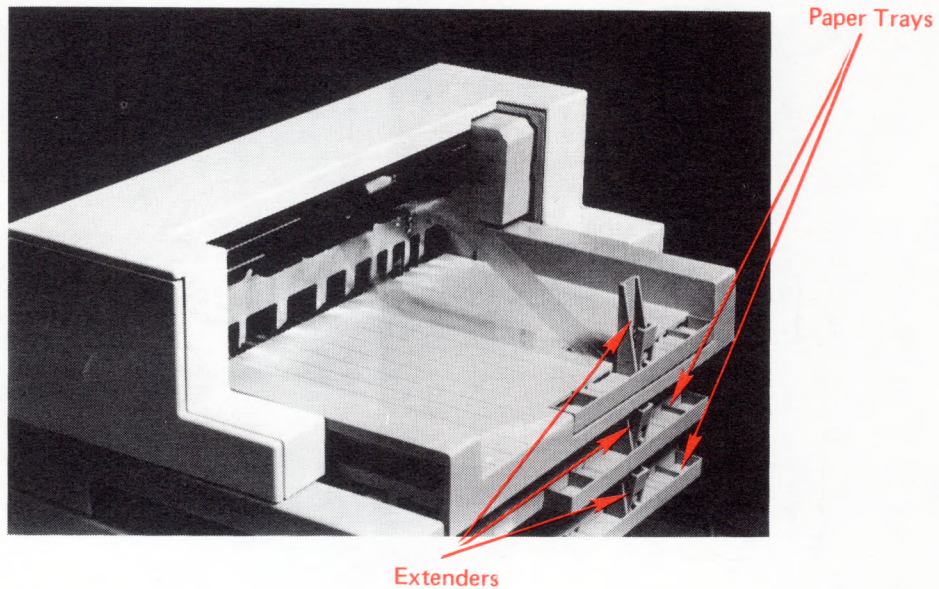

Remove all the paper from both paper trays.

Push the extenders in.

Turn the printer power OFF (O).

Press the thumb latch and unplug the cable.

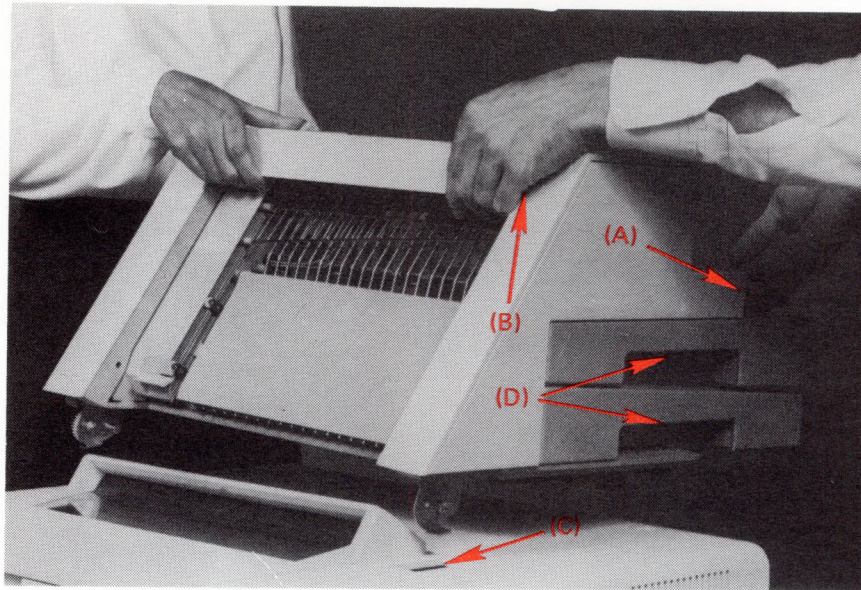

Two people are required to remove the IBM Sheet-Feed Paper Handler. With the two people facing each other on opposite sides of the device, use the hand scoops (A) and the front edge (B) of the IBM Sheet-Feed Paper Handler cover to tilt the device forward. Lift the device straight up and away until the latches (C) are clear of the printer cover openings.

Note: Do not lift by the paper tray handles (D).

Store the IBM Sheet-Feed Paper Handler in a safe place.

This page is left blank intentionally.

CHAPTER 12. IBM FRONT EXIT SHEET FEED

The IBM Front Exit Sheet Feed is an automatic paper/envelope handling device available only for the IBM 5218 Printer. The IBM Front Exit Sheet Feed is available as a paper only feature or as a paper and envelope feature. The front exit sheet feed has two input paper trays each capable of holding approximately 200 cut sheets of 20-pound paper. The paper and envelope feature also is capable of holding approximately 100 envelopes. The paper output tray holds approximately 400 sheets of 20-pound paper and the envelope output tray holds approximately 100 envelopes.

Note: Paper and envelope specifications are described in "Appendix G".

INSTALLATION OF THE IBM FRONT EXIT SHEET FEED

To install the IBM Front Exit Sheet Feed, follow these instructions:

CAUTION

Your IBM Front Exit Sheet Feed weighs approximately 14 kg (31 lbs.) and it is recommended that two people attach it to the printer.

- Turn the printer power Off (0). Remove the Paper Support Table (Chapter 9) or Tractor Feed (Chapter 10) if installed.
- Lift out the cover inserts if they are in place.

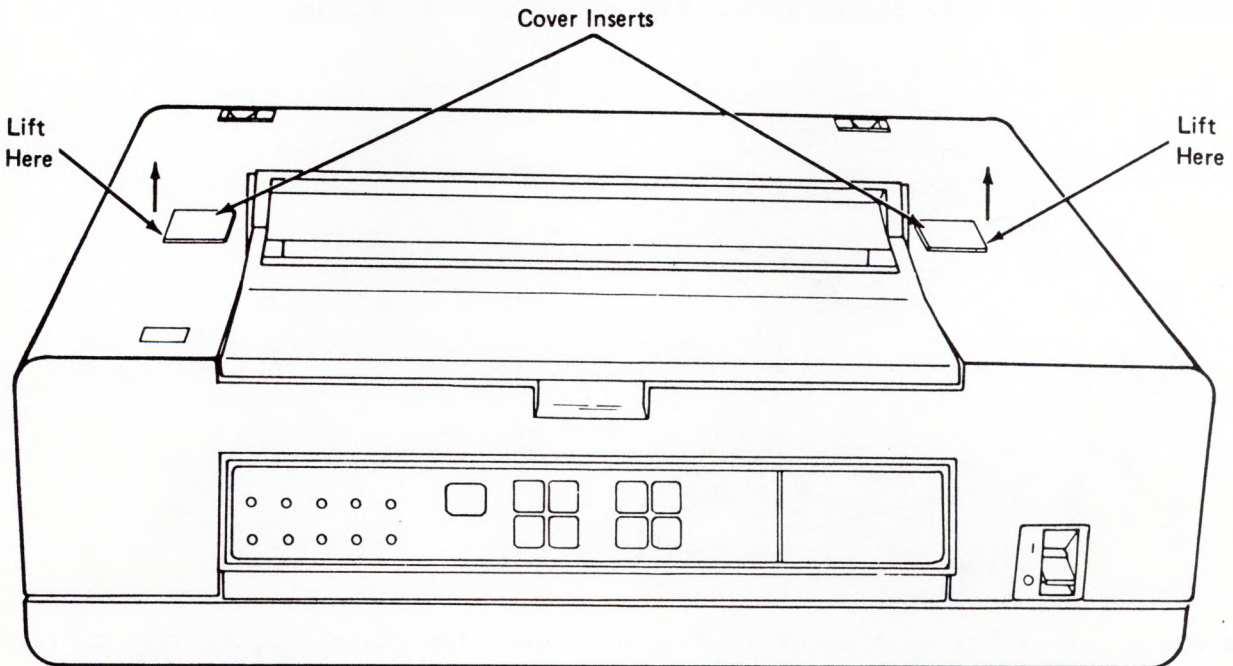

Ensure that all of the paper and envelopes are removed from the paper trays, envelope tray and the output tray. With two people facing each other on opposite sides of the sheet feed, use the the hand scoops and the metal support rod behind the envelope output tray to lower the sheet feed flat on top of the printer with the latches inserted in the printer cover openings.

Warning: Do not lift by the paper tray handles or the output tray. You may damage the trays.

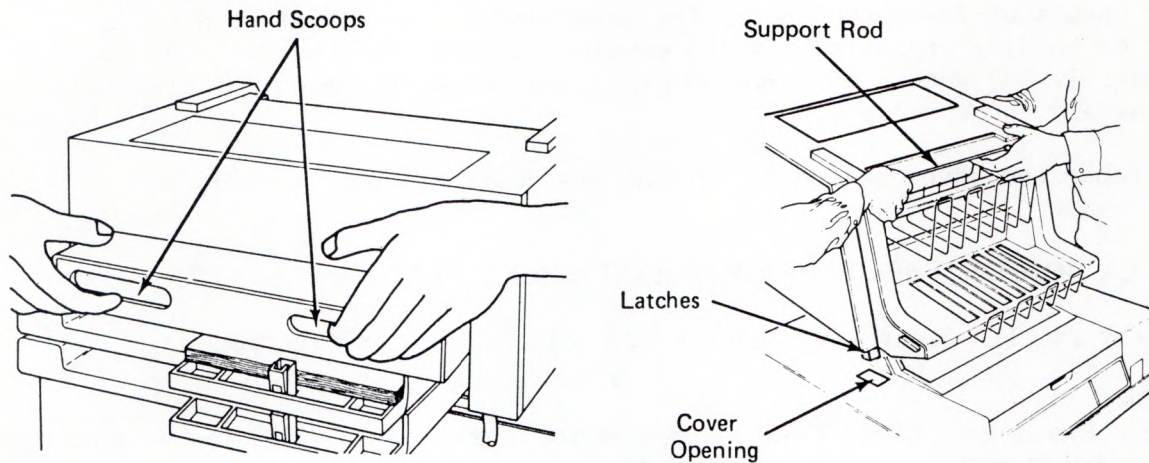

To properly engage the front exit sheet feed, one person standing in front of the sheet feed must tilt the IBM Front Exit Sheet Feed forward approximately 75 to 100 mm (3 to 4 in.) until both sides latch or click into position.

Slowly lower the rear of the sheet feed until it rests on the printer.

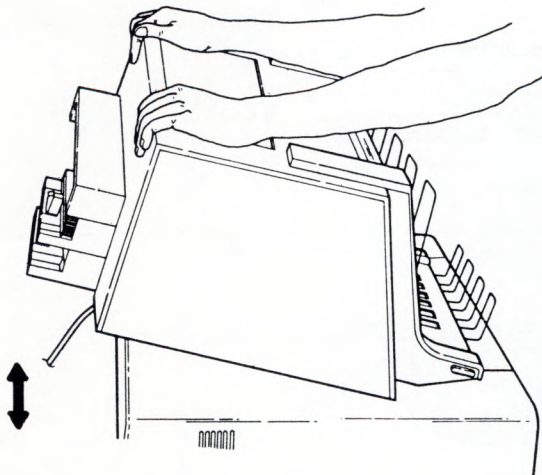

Note: If the front exit sheet feed is not installed correctly, a paper or feed failure will occur.

To check for correct installation, attempt to gently lift the sheet feed at both front corners. If either corner of the sheet feed moves away from the printer, repeat the previous steps.

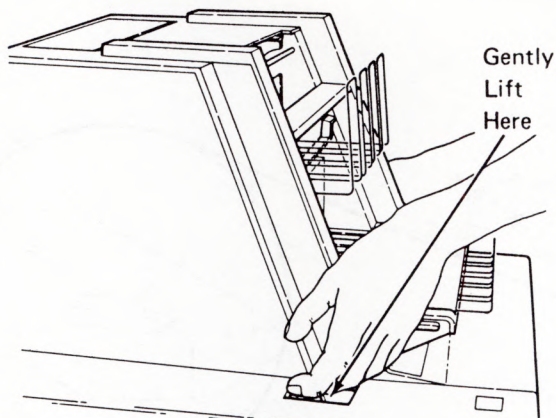

Ensure that the printer is Off (0). Connect the front exit sheet feed cable to the rear of the printer.

Note: Some printers require an adapter cable to connect the sheet feed to the printer. If an adapter is required, install it as shown below.

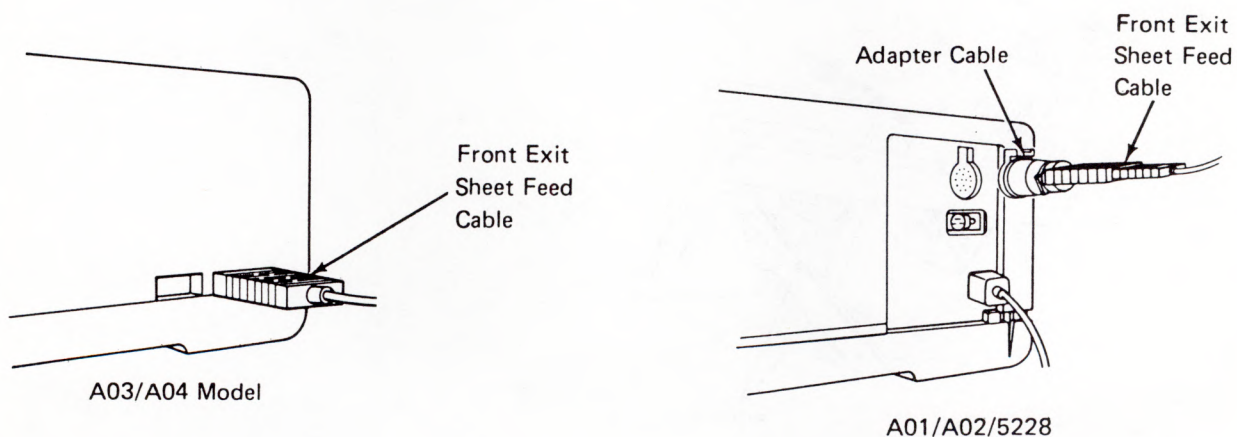

Turn the printer On (I).

This completes the installation of the front exit sheet feed.

POSITIONING THE OUTPUT TRAY TO THE RAISED POSITION

To gain access to the front paper path and the printer, lift the output tray to its raised position. To lift the output tray to the raised position, do the following:

Pull up on the release levers to unlock the output tray.

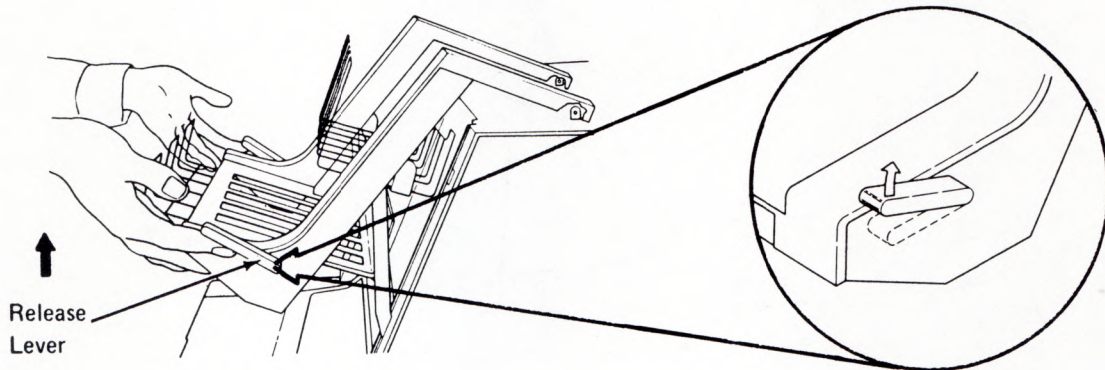

Lift up on the output tray until the support legs snap into the locked raised position.

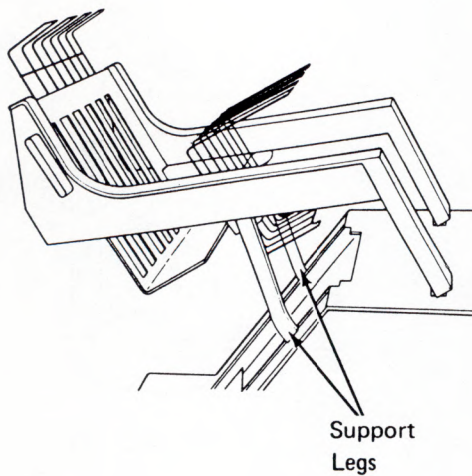

CAUTION

Ensure that your fingers are not between the output tray and the front exit sheet feed when you lower the tray.

To lower the output tray, slightly lift it as you push down on the release levers. Hold the release levers down as you lower the output tray. Once the output tray is down, gently push down on it to ensure that the tray is locked in the operating position.

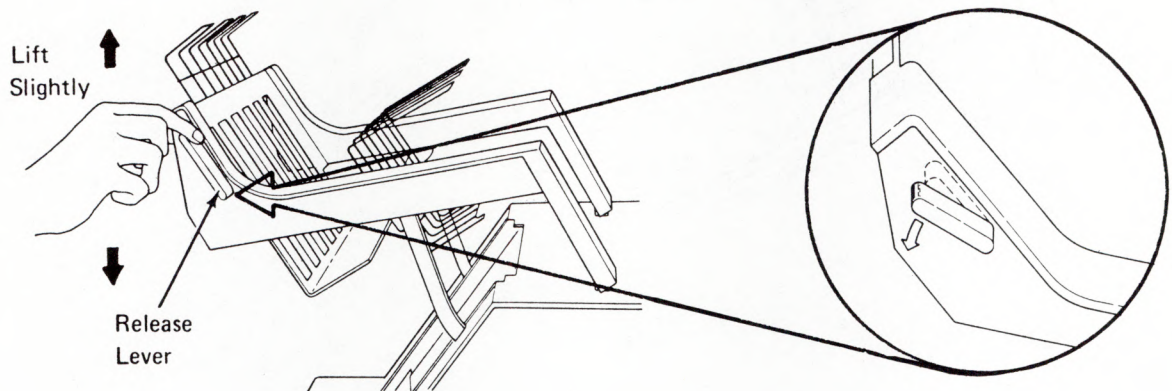

LOADING PAPER OR ENVELOPES MANUALLY WITH THE FRONT EXIT SHEET FEED ATTACHED

Lift the output tray to the raised position (See page 105).

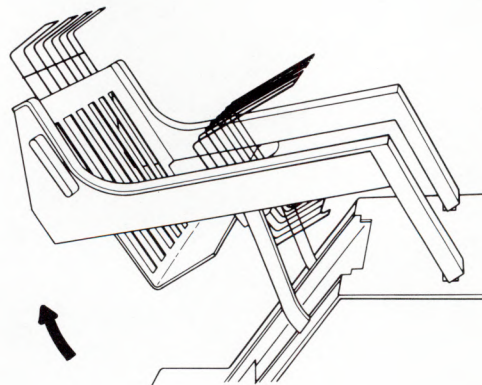

Lift the pressure roller up to its manual feed position.

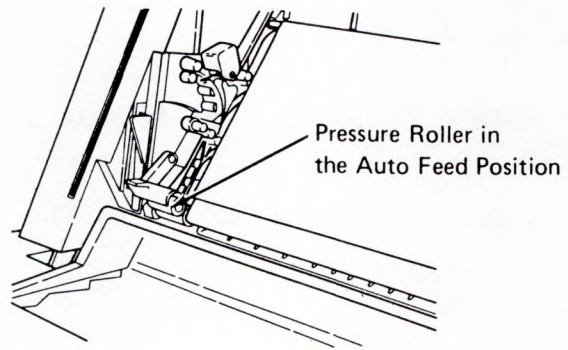
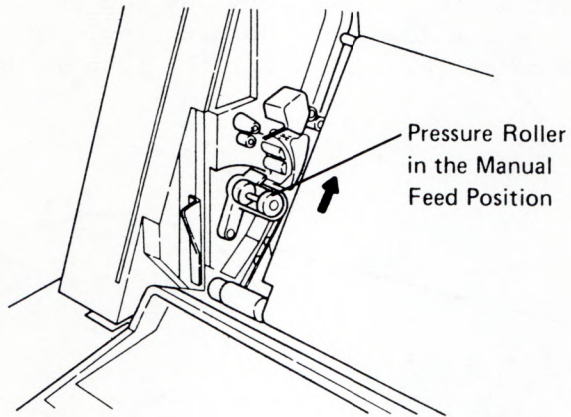

Slide the insertion guide to the right, to the fully extended position.

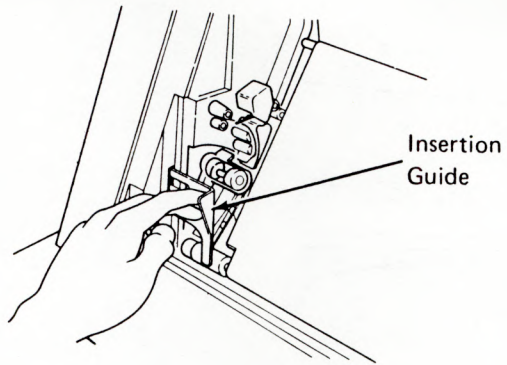

Place the paper into the opening in the printer cover (behind the insertion guide). Use the triangle on the printer to align the left edge of the paper or envelope. The vertical mark on the printer indicates the approximate left edge for paper or envelope less than 150 mm (6 in.) wide. Paper or envelopes must be inserted until they stop against the alignment tabs inside the printer.

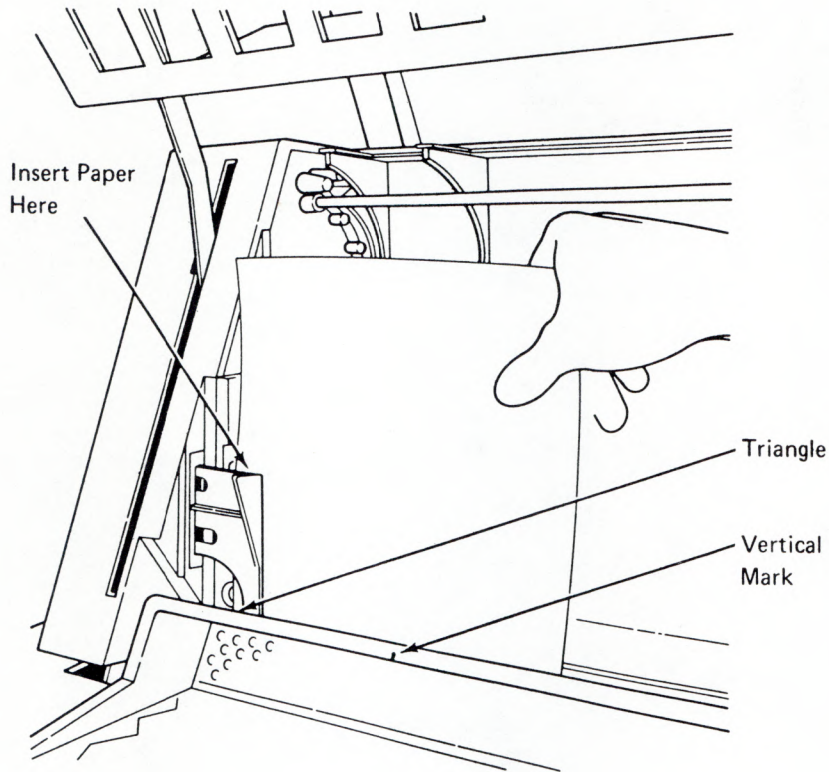

Press **Stop**, then press **Load** to feed the paper or envelope to the print position. Press **Start** to print on the paper or envelope.

Note: When you return to the automatic sheet feed operation, you must push the insertion guide to the left until it stops and is clear of the paper path and then rotate the pressure roller back to the automatic position. Lower the output tray and latch it in the down position. If the output is not completely down and latched, a paper jam may occur when the next sheet of paper or envelope is ejected.

LOADING PAPER AND ENVELOPES INTO THE IBM FRONT EXIT SHEET FEED

The IBM Displaywriter allows you to choose which paper tray you print from. When the PAGE FORMAT menu appears on the screen, make the proper selection for printing paper source. Paper prints from that tray until another selection is made. Review printing procedures in the Work Station Procedures Guide.

Supplies should be stored in the same environment as the machine. If you cannot keep all of the supplies in the same environment, you should store a sufficient supply of paper and envelopes in the operating environment for at least 24 hours prior to use. Proper paper and envelope selection and environmental conditions will help the printer perform at its optimum level. (See Appendix G for paper and envelope specifications.)

Loading Paper In The IBM Front Exit Sheet Feed

Ensure that the front exit sheet feed is installed on the printer before loading paper. If the front exit sheet feed is not installed, refer to page 105 "Installation of the IBM Front Exit Sheet Feed".

The sheet feed has two paper supply trays. These trays are not interchangeable. The top tray has an arrow pointing up. The bottom tray has an arrow pointing down. Each tray can hold approximately 200 cut sheets of 75 gm/m² (20 lb.) paper. (See Appendix G for supplies information.)

To load paper, perform the following steps:

Ensure that the pressure roller is in the automatic feed position and the output tray is latched in the down position. If either of these mechanisms are not in the proper position, an error code 05 (paper jam) will display on the printer two-digit display after the next job prints.

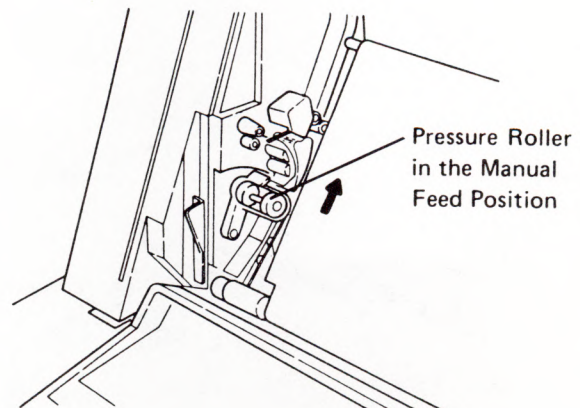
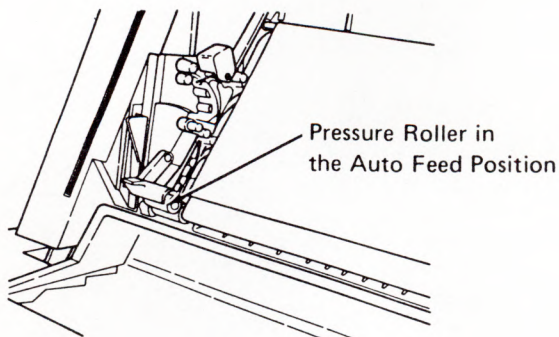

Remove the paper trays from the sheet feed, and set them on a flat surface such as a table top.

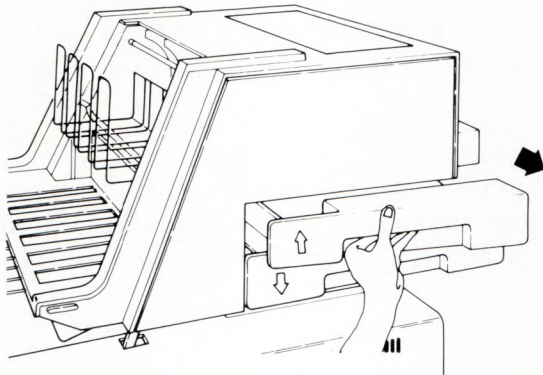

Slide the rear extender and side paper edge guides out far enough to accommodate your paper.

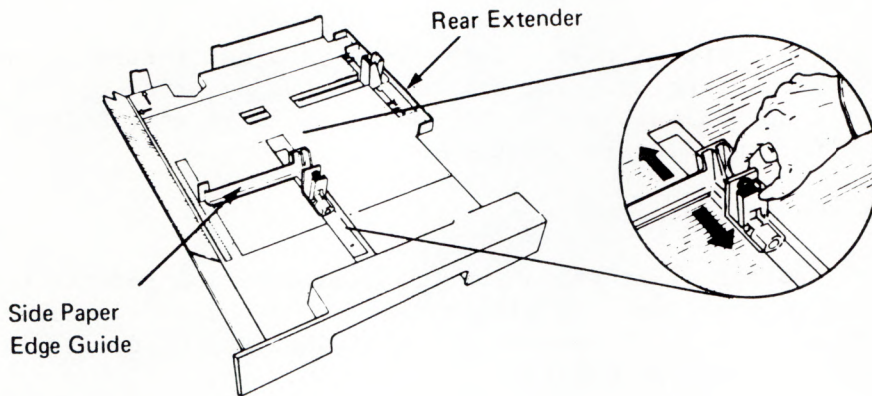

Fan the paper.

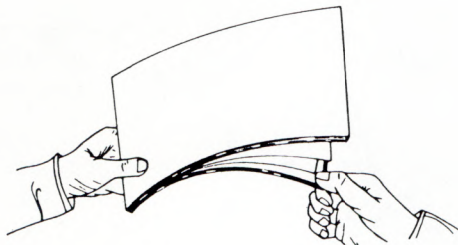

Insert the paper so that:

- The side to be printed faces down.
- The top edge of the paper is toward the front of the printer.
- The paper is flush against the left edge of the paper tray.
- The edge of the paper lies on the load paper line.
- The paper stack is not higher than the tab on the paper edge guide and the ridge on the tray side wall. If you put in too much paper, it will not feed correctly.

Note: Loading paper in front of or behind the load paper line may result in a feed failure caused by feeding more than one sheet at a time.

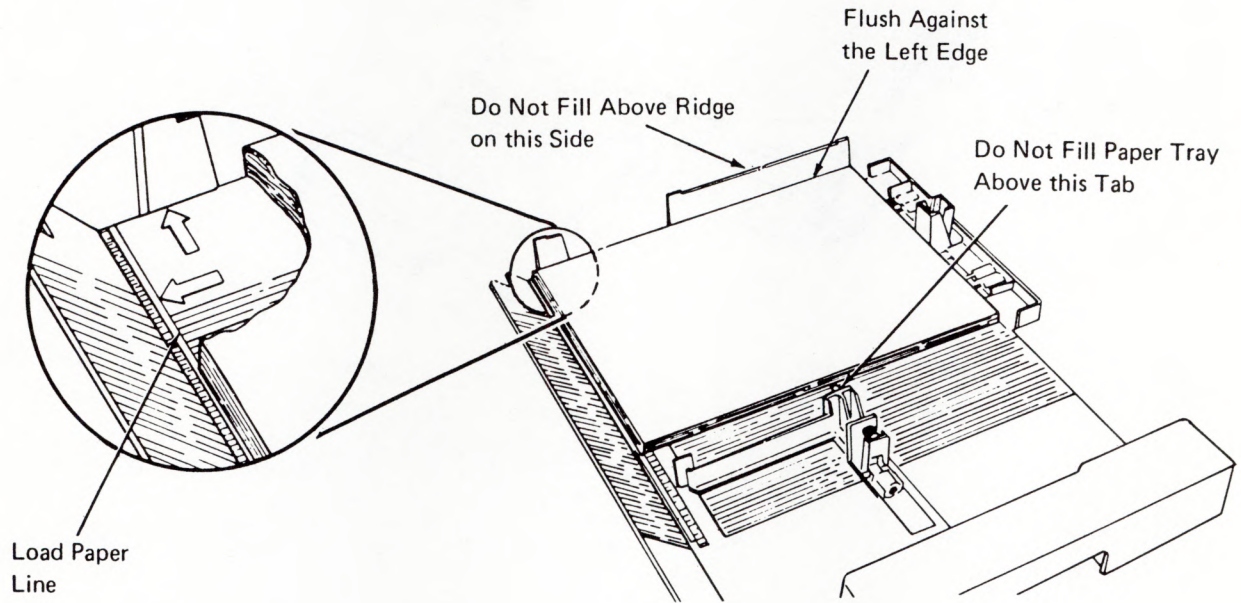

Slide the rear paper edge guide up **loosely** against the rear edge of the paper stack. Slide the side paper edge guide up **loosely** against the edge of the paper stack.

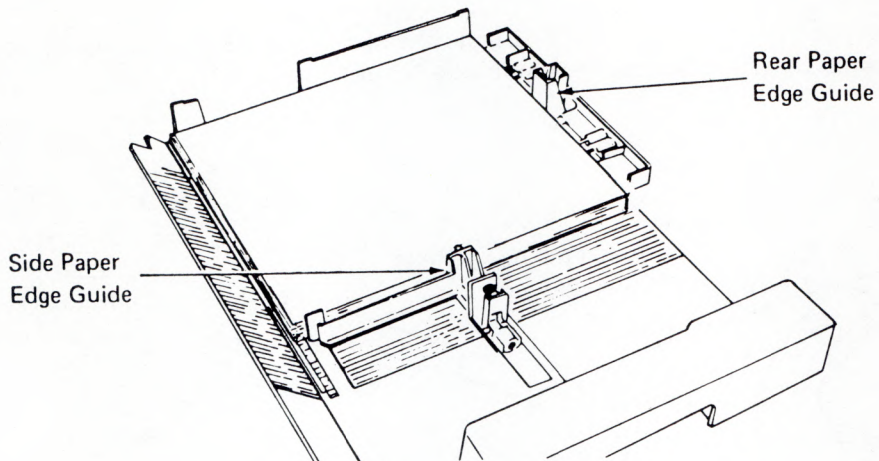

Note: If the side paper edge guide is placed too tightly against the paper stack, it may restrict paper motion and not allow the paper to enter the printer. If the side paper edge guide is placed too loosely against the paper stack, the paper may skew as it leaves the paper tray, causing paper jamming or skewed printing.

Note: The top and bottom trays are not interchangeable. The top tray has an arrow pointing up. The bottom tray has an arrow pointing down.

Slide the paper tray into the sheet feed until the tray clicks into position. Ensure that the tray fits into the sheet feed as shown.

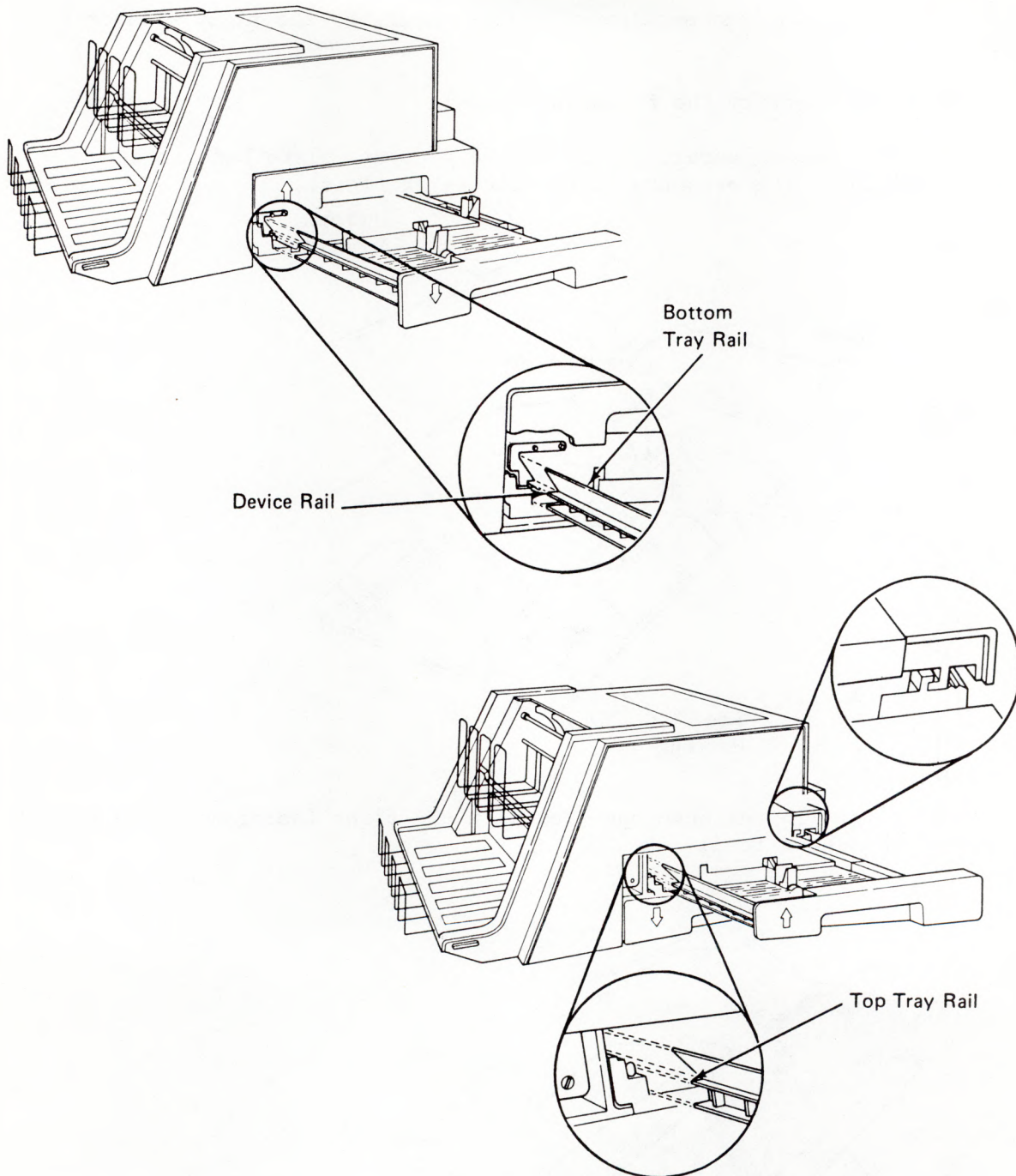

Loading Envelopes In The IBM Front Exit Sheet Feed

If your IBM Front Exit Sheet Feed feeds both paper and envelopes, this section describes how to load envelopes. The envelope tray holds approximately 100 envelopes.

Note: It is easier to load envelopes while standing at the right side of the printer.

To load envelopes, perform the following steps:

Lift the envelope access cover, and slide the pressure plate back to its rear-most position. The pressure plate latches in place.

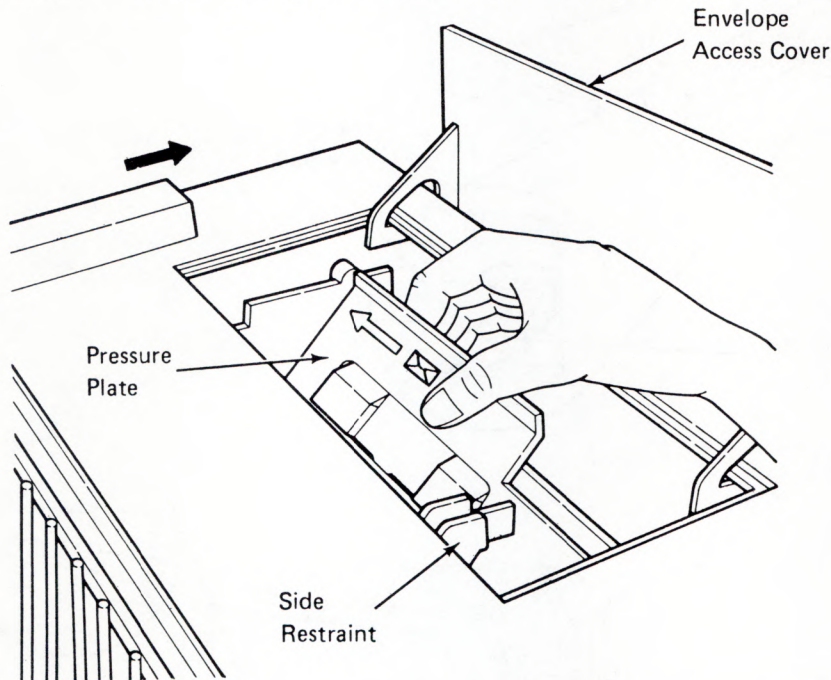

Place the envelopes in the envelope tray with the flaps facing down and towards the front of the sheet feed.

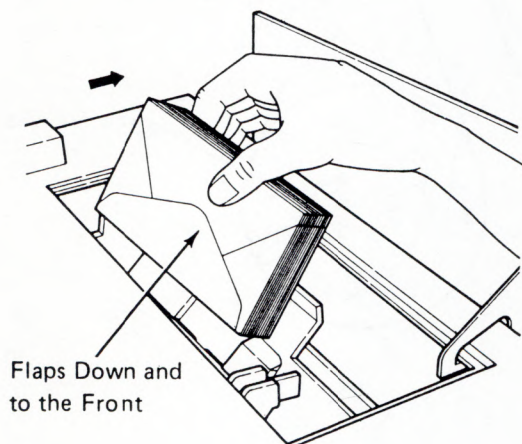

Ensure that the stack of envelopes is uniform and that the envelopes touch the left side wall and the bottom of the envelope tray.

Note: Envelopes will not feed correctly if you mix various envelope sizes and weights.

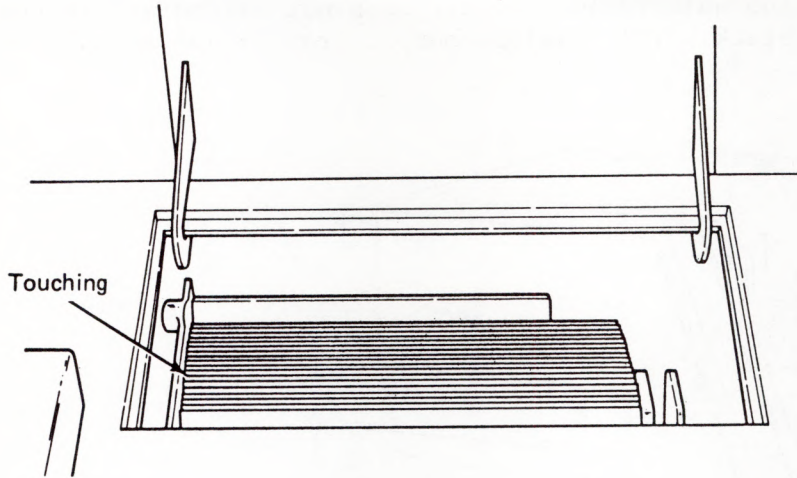

Move the pressure plate release lever forward to release the pressure plate as shown below. Squeeze the right side restraint and position it so that it lightly touches the envelopes.

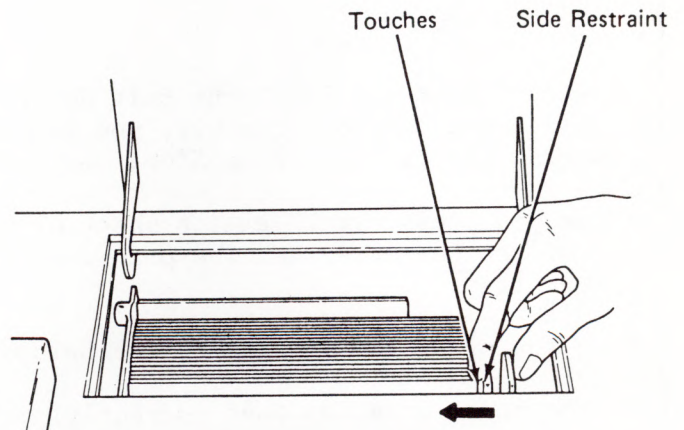
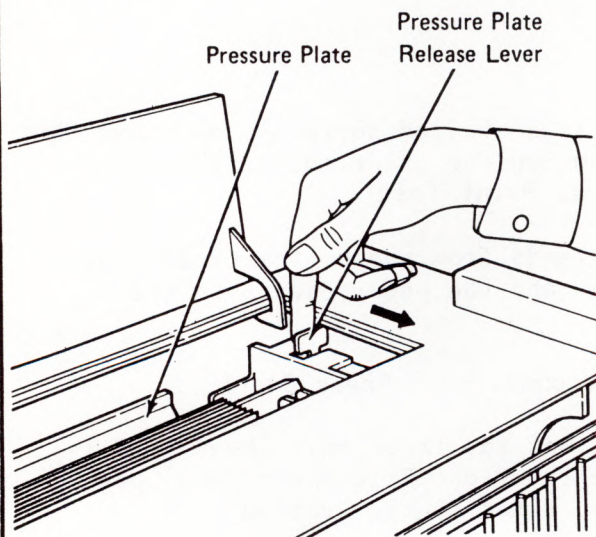

Close the envelope access cover.

Note: Maintaining a neat and uniform stack while loading envelopes will result in a more reliable envelope feed operation.

ADJUSTING THE PAPER OUTPUT TRAY

Place a sheet of paper in the paper output tray that is the same size and faces the same direction as the sheets in the paper input trays. The rear edge of the sheet should be against the rear of the output tray. While holding the tray extenders from both sides, slide the adjustable paper tray extender, in or out, so that it touches the front of the sheet. If sheets of different length are used, the adjustable front tray extender must be adjusted to accommodate the longest sheet. Ensure that the adjustable extender does not extend any farther than necessary for a neater stack. The envelope output tray is not adjustable.

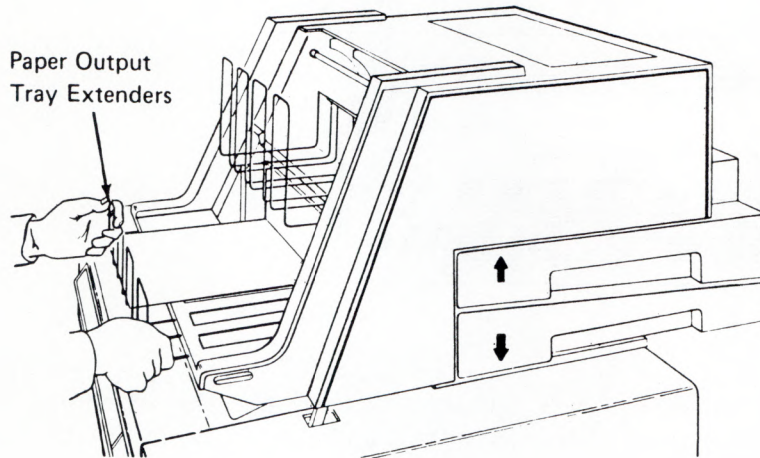

To ensure that the IBM Front Exit Sheet Feed is installed correctly and that the supplies are loaded correctly, you may want to run the print test. (Turn the power switch on (I), press **Stop**, and then press **Print Test**)

After you press **Print Test**, a sheet of paper feeds from the bottom paper tray, all of the characters on the printwheel print, and the paper ejects to the output tray.

When the print test finishes, the **Setup** light comes on. Press **Start**.

If the paper does not feed correctly, verify that the front exit sheet feed is attached correctly. (See 'Installation Of The IBM Front Exit Sheet Feed' page 105.) If paper still fails to feed correctly, refer to the Problem Determination Procedures.

You have completed loading the front exit sheet feed. Press **Start**. The printer will begin to print when it receives a job.

CLEARING MISFEEDS FROM THE IBM FRONT EXIT SHEET FEED

Note: Supplies and environment play an important role in proper machine operation. Work with your paper supplier to select acceptable paper for your application. All paper should be new, unused, and without packaging damage.

Supplies should be stored in the same environment as the machine. If you cannot do so, store a sufficient supply of paper and envelopes in the operating environment for at least 24 hours prior to use. Proper paper and envelope selection and storage will help the machine perform at its optimum level. (See Appendix G.)

Excessive curl or waviness in the paper may cause paper jams. Turning the paper over or around may help the paper feed better.

Output Path

If the paper or envelope is jammed in the output path, lift the output tray, remove the paper or envelope, and then lower and lock the output tray.

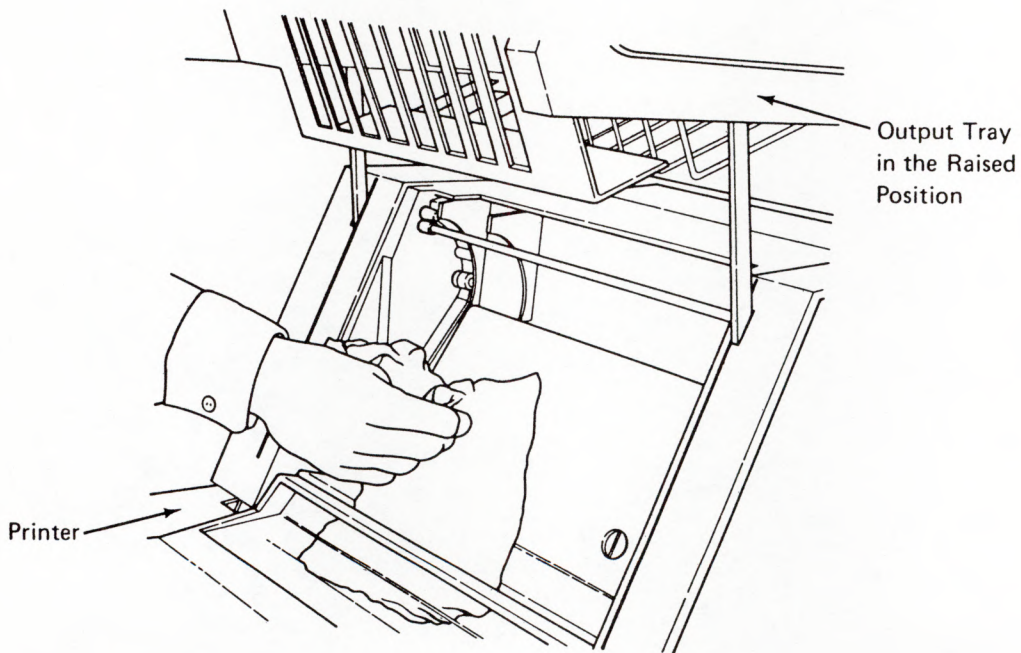

Input Paper Path

If paper is jammed in the input paper path do the following:

Lift the output tray to the raised position. Lift the splitter up and pull the paper out of the paper path.

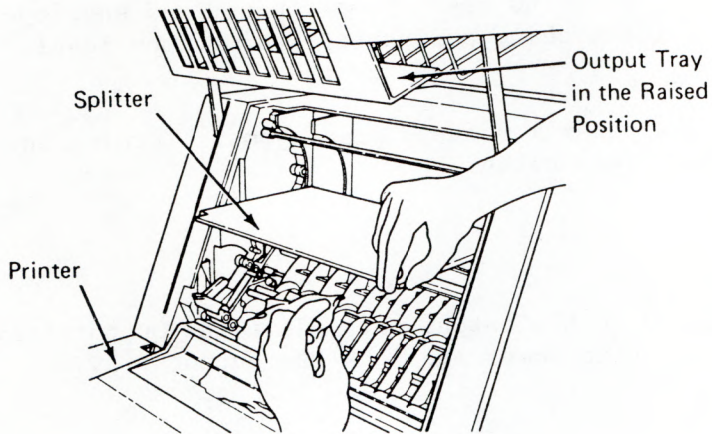

If you cannot pull out the paper, pull the paper tray out and remove the jammed sheet. Realign the paper and replace the paper tray. Press **Start**.

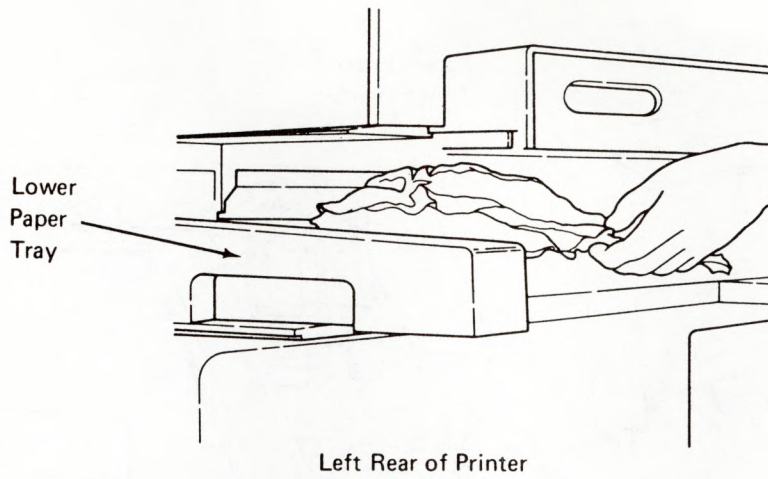

If paper or envelopes are jammed in the printer, lift the output tray to the raised position, press **Release**, and remove the paper or envelope; then press **Release** again. Press **Start**.

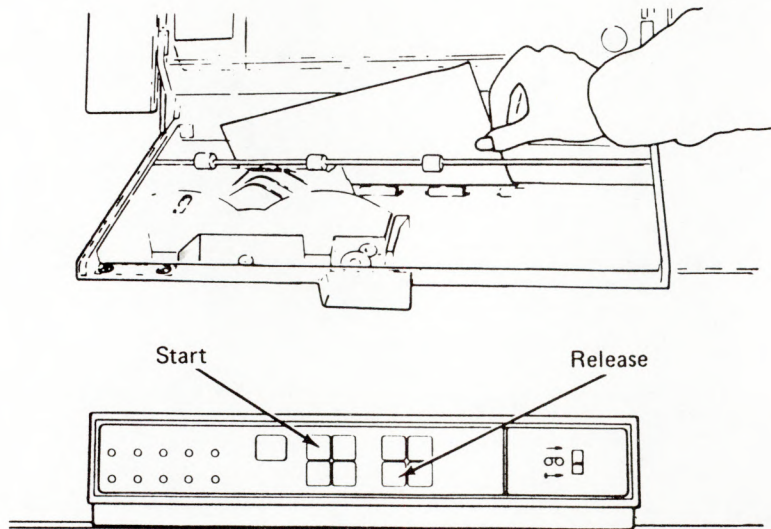

REMOVING THE IBM FRONT EXIT SHEET FEED

Remove the paper from the paper trays and output tray, and remove the envelopes from the envelope tray and output tray. Push the extenders on the paper trays and paper output tray in.

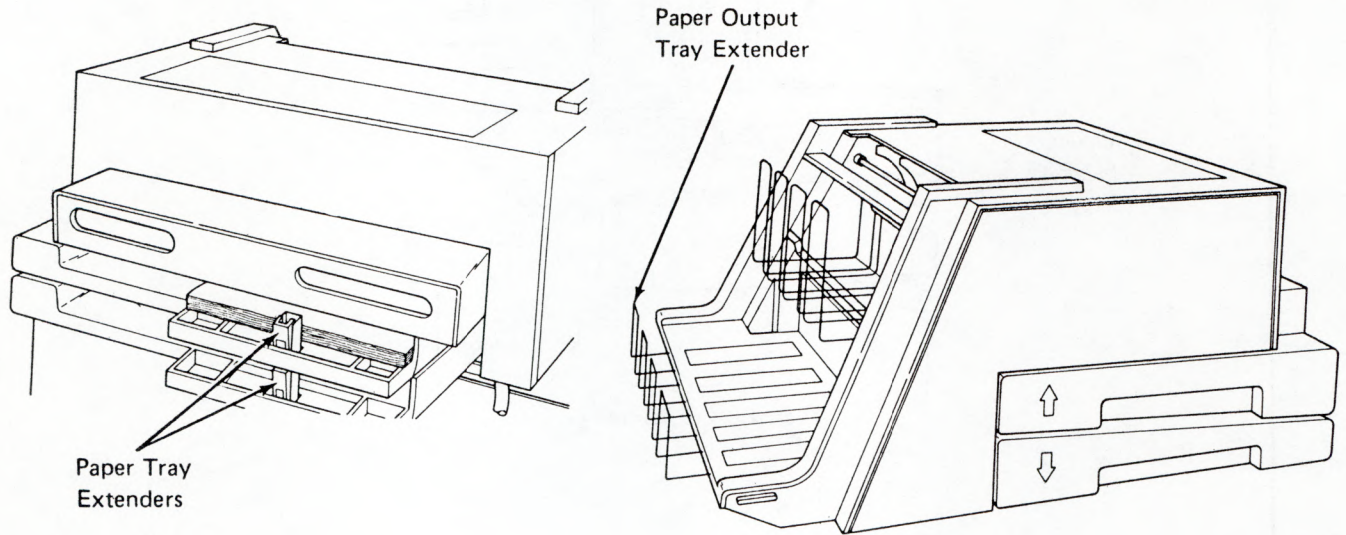

Turn the printer Off (O). Press the spring-loaded thumb latch or unplug the sheet feed cable from the rear of the printer.

It is recommended that two people remove the front exit sheet feed. Facing each other on opposite sides of the sheet feed, use the hand scoops and the metal support rod behind the envelope output to tilt the sheet feed forward; then lift the sheet feed straight up and away from the printer. Store the front exit sheet feed in a safe place.

Warning: Do not lift by the paper tray handles or the output tray. You may damage the trays.

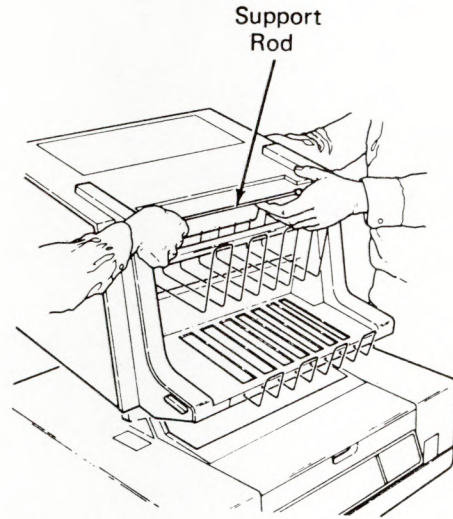
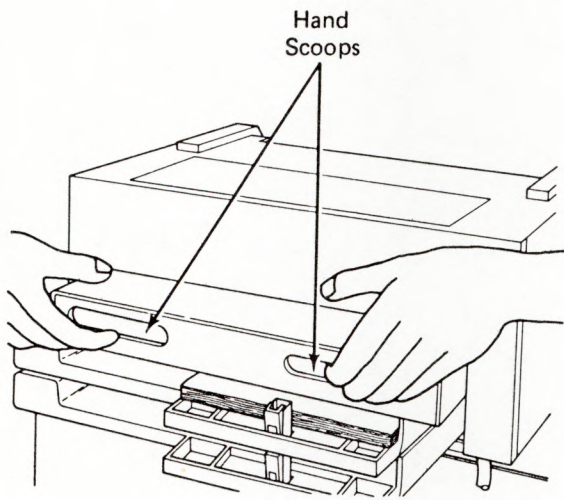

CHAPTER 13. SUPPLIES

SUPPLIES ORDERING

Any IBM supply item can be ordered in the continental United States by contacting your local IBM Branch office, or by calling IBM DIRECT at the following toll-free numbers: (Alaska, Hawaii, and Puerto Rico are not included.)

800-631-5582

800-352-4960 (New Jersey)

PRINTWHEEL CARTRIDGES

Printwheel cartridges and type style catalogs for the IBM 5218/IBM 5228 Printwheel Printer can be obtained from your IBM Marketing Representative. Printwheels that are not encased in a cartridge are not compatible with the IBM 5218/IBM 5228 Printwheel Printer. Printwheel cartridges equivalent to the IBM 5218/IBM 5228 Printwheel Printer cartridges may also be used.

RIBBONS

The IBM 5218/IBM 5228 Printwheel Printer uses a long-life IBM TECH III cartridge ribbon (part number 1299463), or equivalent, with an average yield of one million characters.

CABLES

Connecting-cables for the IBM 5218/IBM 5228 Printwheel Printer are available in lengths of 3, 6, 30, and 60 meters (9.9, 19.7, 98, and 197 feet). Equivalent cables may also be used.

EXTRA PAPER TRAYS

Additional top or bottom paper trays can be ordered to accommodate the use of different types of paper. Contact your IBM Representative for more information. The top and bottom paper trays are not interchangeable.

PAPER STAND

Paper Stand (part number 1494596) is recommended for use with the IBM Tractor Feed and continuous forms. The paper stand will hold and stack continuous forms after printing.

PAPER SUPPORT TABLE

The Paper Support Table simplifies manual paper loading. It is recommended for use when cut sheet paper is being used and no other paper handling devices are attached.

ADAPTER CABLES

An adapter cable is required to connect the IBM Front Exit Sheet Feed to the IBM 5218 Printer model A01 or A02.

An adapter cable is required to connect the IBM Sheet Feed Paper Handler to the IBM 5218 Printer model A03 or A04.

CHAPTER 14. CARE AND CLEANING

CLEANING

The printer covers may be cleaned with a damp cloth and a mild soap solution.

Do not clean the printwheels.

APPENDIX A. IBM 5215 PRINTER ELEMENT DESCRIPTIONS

The following charts list the U.S. and non-U.S. type styles used with the IBM Displaywriter System and the IBM 5215 Printer. This chart can help you determine which type styles and keyboard numbers match the type style part numbers you will use for printing. You can also use this chart when changing the program diskette to match your printer element and keyboard numbers.

For additional information on using this chart, refer to "Changing Your Program Diskette to Match Your Printer Element and Keyboard Number" in the IBM Displaywriter System Operator Training Book 2 -- Selectable Topics.

U.S. TYPESTYLES

Type Style Name	Pitch	Part No.	Type Style ID No.	Keyboard ID No.
Adjutant	12	129	095	002
Adjutant	12	031	095	003
Adjutant	12	030	095	004
Advocate	10	130	001	002
Advocate	10	036	001	003
Advocate	10	050	001	004
Artisan 12-72	12	131	081	002
Artisan 12-72	12	055	081	003
Artisan 12-72	12	053	081	004
Auto Elite	12	208	082	002
Bookface Academic	10	158	015	002
Courier 12	12	132	085	002
Courier 12	12	068	085	003
Courier 12	12	067	085	004
Courier 12 Italic	12	133	092	002
Courier 12 Italic	12	086	092	003
Courier 12 Italic	12	085	092	004
Courier 72	10	134	011	002
Courier 72	10	029	011	003
Courier 72	10	015	011	004
Courier 72	10	093	011	005

Type Style Name	Pitch	Part No.	Type Style ID No.	Keyboard ID No.
Courier 72	10	051	011	006
Courier 72 (Legal)	10	177	011	007
Courier 72 (Legal)	10	178	011	008
Delegate	10	135	002	002
Delegate	10	035	002	003
Delegate	10	070	002	004
Delegate	10	093	002	005
Dual Gothic	12	136	090	002
Dual Gothic	12	021	090	003
Dual Gothic	12	020	090	004
Elite 72	12	137	083	002
Elite 72	12	026	083	003
Elite 72	12	007	083	004
Large Elite	12	161	089	054
Letter Gothic	12	138	087	002
Letter Gothic	12	039	087	003
Letter Gothic	12	005	087	004
Light Italic	12	139	091	002
Light Italic	12	032	091	003
Light Italic	12	017	091	006
Pica 72	10	142	020	002
Pica 72	10	027	020	003
Pica 72	10	017	020	006
Prestige Elite 72	12	143	086	002
Prestige Elite 72	12	033	086	003
Prestige Elite 72	12	012	086	004
Prestige Elite 72	12	049	086	006
Prestige Elite 72	12	179	086	007
Prestige Elite 72	12	180	086	008
Prestige Pica	10	123	012	002
Prestige Pica	10	181	012	007
Prestige Pica	10	182	012	008
Scribe	12	144	080	002
Scribe	12	025	080	003
Scribe	12	001	080	004

Type	Style Name	Pitch	Part No.	Type Style ID No.	Keyboard ID No.
Script		12	145	084	002
Script		12	034	084	003
Script		12	090	084	005
Manifold		10	140	014	002
Manifold		10	028	014	003
Manifold		10	010	014	005
Orator		10	141	005	002
Orator		10	060	005	003
Orator		10	010	005	005
Symbol*		10	061	--	200
Symbol*		12	004	--	200
Prestige Pica		10	172	012	017
Bookface Academic		10	174	015	018
Prestige Elite		12	195	086	019

*The Symbol printer elements do not require a special type style. Use the one that is available for your keyboard.

NON-U.S. TYPESTYLES

Type	Style Name	Pitch	Part No.	Type Style ID No.	Keyboard ID No.
Adjutant		12	129	095	036
Advocate		10	003	001	024
Advocate		10	541	001	032
Advocate		10	774	001	038
Advocate		10	821	001	042
Advocate		10	821	001	080
Advocate		10	881	001	044
Advocate		10	701	001	046
Advocate		10	621	001	052
Advocate		10	661	001	054
Advocate		10	661	001	056
Advocate		10	581	001	066
Advocate		10	993	001	086
Advocate		10	968	001	090
Advocate		10	970	001	094

Type Style Name	Pitch	Part No.	Type Style ID No.	Keyboard ID No.
Artisan 12-72	12	062	081	024
Artisan 12-72	12	835	081	042
Artisan 12-72	12	635	081	052
Artisan 12-72	12	855	081	062
Artisan 12-72	12	982	081	086
Artisan 12-72	12	984	081	094
Auto Elite	12	208	082	036
Bookface Academic	10	602	015	066
Courier 12	12	200	085	024
Courier 12	12	054	085	032
Courier 12	12	836	085	042
Courier 12	12	894	085	044
Courier 12	12	714	085	046
Courier 12 Italic	12	559	092	032
Courier 12 Italic	12	133	092	036
Courier 12 Italic	12	660	092	094
Courier 72	10	040	011	024
Courier 72	10	547	011	032
Courier 72	10	827	011	042
Courier 72	10	887	011	044
Courier 72	10	707	011	046
Courier 72	10	747	011	048
Courier 72	10	587	011	066
Courier 72	10	952	011	074
Courier 72	10	921	011	082
Courier 72	10	919	011	086
Courier 72	10	918	011	090
Courier 72	10	998	011	200
Delegate	10	002	002	024
Delegate	10	542	002	032
Delegate	10	822	002	042
Delegate	10	822	002	080
Dual Gothic	12	551	090	032
Dual Gothic	12	831	090	042
Dual Gothic	12	831	090	080
Elite 72	12	939	083	026
Elite 72	12	543	083	032
Elite 72	12	823	083	042

Type Style Name	Pitch	Part No.	Type Style ID No.	Keyboard ID No.
Elite 72	12	703	083	046
Elite 72	12	773	083	048
Elite 72	12	623	083	052
Elite 72	12	823	083	080
Elite 72	12	663	083	054
Elite 72	12	663	083	056
Elite 72	12	583	083	066
Large Elite	12	161	089	036
Letter Gothic	12	063	087	024
Letter Gothic	12	553	087	032
Letter Gothic	12	833	087	042
Letter Gothic	12	833	087	080
Letter Gothic	12	893	087	044
Letter Gothic	12	138	087	036
Letter Gothic	12	641	087	094
Light Italic	12	552	091	032
Light Italic	12	780	091	038
Light Italic	12	832	091	042
Light Italic	12	832	091	080
Light Italic	12	892	091	044
Light Italic	12	712	091	046
Light Italic	12	752	091	048
Light Italic	12	632	091	052
Light Italic	12	672	091	054
Light Italic	12	672	091	056
Light Italic	12	852	091	062
Light Italic	12	962	091	082
Light Italic	12	962	091	084
Light Italic	12	640	091	086
Light Italic	12	987	091	094
Pica 72	10	937	020	026
Pica 72	10	544	020	032
Pica 72	10	824	020	042
Pica 72	10	614	020	086
Prestige Elite 72	12	033	086	016
Prestige Elite 72	12	041	086	024
Prestige Elite 72	12	545	086	032
Prestige Elite 72	12	784	086	038
Prestige Elite 72	12	825	086	042
Prestige Elite 72	12	885	086	044
Prestige Elite 72	12	585	086	066

Type Style Name	Pitch	Part No.	Type Style ID No.	Keyboard ID No.
Prestige Pica	10	198	012	024
Prestige Pica	10	123	012	036
Scribe	12	018	080	024
Scribe	12	546	080	032
Scribe	12	826	080	042
Scribe	12	902	080	074
Script	12	548	084	032
Script	12	777	084	038
Script	12	708	084	046
Script	12	748	084	048
Script	12	628	084	052
Script	12	668	084	054
Script	12	668	084	056
Script	12	848	084	062
Orator	10	557	005	032
Orator	10	897	005	044
Orator	10	757	005	048
Orator	10	637	005	052
Orator	10	661	005	086
Orator	10	630	005	094

APPENDIX B. IBM 5215 PRINTER MESSAGE DESCRIPTIONS

The following chart lists the message numbers and the corresponding type styles and part numbers needed when the message, Put on Printer Element xxx-xxx, appears on the display.

For additional information on this chart, refer to "Changing Your Program Diskette to Match Your Printer Elements and Keyboard Numbers" in the IBM Displaywriter System Operator Training Book 2 -- Selectable Topics..

Message	Type Style Name	Part No.
001-002	Advocate	130
001-003	Advocate	036
001-004	Advocate	050
001-024	Advocate	003
001-032	Advocate	541
001-038	Advocate	774
001-042	Advocate	821
001-080	Advocate	821
001-044	Advocate	881
001-046	Advocate	701
001-052	Advocate	621
001-054	Advocate	661
001-056	Advocate	661
001-066	Advocate	581
001-086	Advocate	993
001-090	Advocate	968
001-094	Advocate	970
002-002	Delegate	135
002-036	Delegate	135
002-003	Delegate	035
002-004	Delegate	070
002-005	Delegate	093
002-024	Delegate	002
002-032	Delegate	542
002-042	Delegate	822
002-080	Delegate	822
005-002	Orator	141
005-003	Orator	060
005-005	Orator	010
005-032	Orator	557
005-044	Orator	897
005-048	Orator	757
005-052	Orator	637

Message	Type Style Name	Part No.
005-086	Orator	661
005-094	Orator	630
011-002	Courier 72	134
011-003	Courier 72	029
011-004	Courier 72	015
011-005	Courier 72	093
011-006	Courier 72	051
011-007	Courier 72	177
001-008	Courier 72	178
011-024	Courier 72	040
011-032	Courier 72	547
011-042	Courier 72	827
011-044	Courier 72	887
011-046	Courier 72	707
011-048	Courier 72	747
011-066	Courier 72	587
011-074	Courier 72	952
011-082	Courier 72	921
011-086	Courier 72	919
011-090	Courier 72	090
011-200	Courier 72	200
012-002	Prestige Pica	123
012-036	Prestige Pica	123
012-024	Prestige Pica	198
012-007	Prestige Pica	181
014-002	Manifold	140
014-003	Manifold	028
014-005	Manifold	101
015-002	Bookface Academic	158
015-066	Bookface Academic	602
020-002	Pica 72	142
020-003	Pica 72	027
020-006	Pica 72	017
020-008	Pica 72	012
020-026	Pica 72	947
020-032	Pica 72	544
020-042	Pica 72	824
020-086	Pica 72	614
080-002	Scribe	744
080-003	Scribe	025
080-004	Scribe	018
080-032	Scribe	546

Message	Type Style Name	Part No.
080-042	Scribe	826
080-074	Scribe	902
081-002	Artisan 12-72	131
081-003	Artisan 12-72	055
081-004	Artisan 12-72	053
001-024	Artisan 12-72	062
081-042	Artisan 12-72	835
081-052	Artisan 12-72	635
081-062	Artisan 12-72	855
081-086	Artisan 12-72	982
081-094	Artisan 12-72	984
082-002	Auto Elite	208
082-036	Auto Elite	208
083-002	Elite 72	137
083-003	Elite 72	026
083-004	Elite 72	007
083-026	Elite 72	503
083-032	Elite 72	543
083-042	Elite 72	823
083-046	Elite 72	703
083-048	Elite 72	773
083-052	Elite 72	623
083-054	Elite 72	663
083-056	Elite 72	663
083-066	Elite 72	583
083-080	Elite 72	823
083-086	Elite 72	939
084-002	Script	145
084-003	Script	034
084-005	Script	090
084-032	Script	548
084-038	Script	777
084-046	Script	708
084-048	Script	748
084-052	Script	628
084-054	Script	668
084-056	Script	668
084-062	Script	848
085-002	Courier 12	132
085-003	Courier 12	068
085-004	Courier 12	067
085-024	Courier 12	200
085-032	Courier 12	554

Message	Type Style Name	Part No.
085-042	Courier 12	836
085-044	Courier 12	894
085-046	Courier 12	714
086-002	Prestige Elite	143
086-003	Prestige Elite	033
086-004	Prestige Elite	012
086-006	Prestige Elite	049
086-007	Prestige Elite	179
086-008	Prestige Elite	180
086-019	Prestige Elite	033
086-024	Prestige Elite	041
086-038	Prestige Elite	575
086-042	Prestige Elite	825
086-044	Prestige Elite	885
086-066	Prestige Elite	585
087-002	Letter Gothic	138
087-003	Letter Gothic	039
087-004	Letter Gothic	005
087-024	Letter Gothic	063
087-032	Letter Gothic	553
087-036	Letter Gothic	136
087-042	Letter Gothic	833
087-044	Letter Gothic	893
087-080	Letter Gothic	833
087-094	Letter Gothic	641
089-002	Large Elite	161
089-036	Large Elite	161
090-002	Dual Gothic	136
090-003	Dual Gothic	021
090-004	Dual Gothic	020
090-032	Dual Gothic	551
090-042	Dual Gothic	831
090-080	Dual Gothic	831
091-002	Light Italic	139
091-003	Light Italic	032
091-006	Light Italic	007
091-032	Light Italic	552
091-038	Light Italic	780
091-042	Light Italic	832
091-080	Light Italic	832
091-044	Light Italic	892
091-046	Light Italic	712
091-048	Light Italic	752

Message	Type Style Name	Part No.
091-052	Light Italic	632
091-054	Light Italic	672
091-056	Light Italic	672
091-062	Light Italic	852
091-082	Light Italic	962
091-084	Light Italic	962
091-086	Light Italic	640
091-094	Light Italic	987
092-002	Courier Italic	133
092-036	Courier Italic	133
092-003	Courier Italic	086
092-004	Courier Italic	085
092-032	Courier Italic	559
092-094	Courier Italic	660
095-002	Adjutant	129
095-036	Adjutant	129
095-003	Adjutant	031
095-004	Adjutant	030

This page is left blank intentionally.

APPENDIX C. IBM 5215 PRINTER SPECIFICATIONS

TYPE STYLES

See "Appendix A. IBM 5215 Printer Element Descriptions" for available type styles.

PAPER SPECIFICATIONS

Manually-fed Paper can be up to 381.0 mm (15 inches) wide with a 317.5 mm (12.5 inch) writing line.

Paper Types

Continuous-form paper may be either single-part (without carbon copies) or multi-part (with carbon copies).

Note: When using multi-part continuous forms, all "plies" (copies and carbon paper) must be "positively" fastened at one edge so that they do not separate before reaching the exit tractor drive pins. "Positive" fastening refers to the optional secure fastening methods available from most major forms-manufacturing companies.

Paper Sizes

Continuous paper measuring 133.35 to 333.5 mm (5.25 to 13.13 inches) pin-to-pin can be used, depending on the width of the Pin-Feed Platen. Pin-Feed Platens are available in the following widths (pin-to-pin):

- 133.4 mm (5.3 inches)
- 152.4 mm (6.0 inches)
- 190.5 mm (7.5 inches)
- 203.2 mm (8.0 inches)
- 228.6 mm (9.0 inches)
- 238.1 mm (9.4 inches)
- 250.8 mm (9.9 inches)
- 254.0 mm (10.0 inches)
- 257.2 mm (10.1 inches)
- 285.8 mm (11.3 inches)

- 292.1 mm (11.5 inches)
- 317.5 mm (12.5 inches)
- 333.4 mm (13.1 inches)

Note: The acceptable form width is 12.7 mm (0.5 inches) wider than the pin-to-pin width. The writing line will be 6.35 mm (0.25 inch) less than the pin-to-pin width.

RECOMMENDED ENVIRONMENT FOR THE PIN-FEED PLATEN

Temperature: 15.5^o to 29.4^o C (60^o to 90^o F)

Humidity: 30 to 65 percent relative humidity

APPENDIX D. IBM 5218/IBM 5228 PRINTWHEEL PRINTER TYPE STYLES/PRINTWHEELS

The following is a list of type styles/printwheels that are available on the IBM 5218/IBM 5228 Printwheel Printer.

Periodically new type styles/printwheels are announced. Consult your IBM marketing representative for the most up-to-date list.

COURIER (10 Pitch)

ABCDEFGHIJKLMNOPQRSTUVWXYZ
abcdefghijklmnopqrstuvwxyz
°!@#%&*()_+[¼³":?.,¶±1234567890-]=½²';/.,§

PRESTIGE PICA (10 pitch)

ABCDEFGHIJKLMNOPQRSTUVWXYZ
abcdefghijklmnopqrstuvwxyz
°!@#%&*()_+[¼³":?.,¶±1234567890-]=½²';/.,§

ARTISAN (10 pitch)

ABCDEFGHIJKLMNOPQRSTUVWXYZ
abcdefghijklmnopqrstuvwxyz
°!@#%&*()_+[¼³":?.,¶±1234567890-]=½²';/.,§

COURIER (12 pitch)

ABCDEFGHIJKLMNOPQRSTUVWXYZ
abcdefghijklmnopqrstuvwxyz
°!@#%&*()_+[¼³":?.,¶±1234567890-]=½²';/.,§

SYMBOL 2

αβ≅φεπλη+θκ}μνοργλστξ×δ←u→∇≥ΨΦχΠΛη†ˆς{θ@'θΓΘΣζΞαΔ≡Τψ0123456789
`±_□≤"\\♀~≠•˙÷'ıſ-@'Ω~σ..)]ω[√∞(-↓ο

SYMBOL 3

αβ≅φεπλη⊥θκ}μνοργλστξ×δ←u→∇≥ΨΦχΠΛ∅†>α{θ@<θΓΘΣζΞαΔ≡Τψ0123456789
††™□≤ε\γ^Lz•T÷'ıſ-@'Ω~σ..)]ω[√∞||ℝ↓|

PRESTIGE 15

abcdefghijklmnopqrstuvwxyzABCDEFGHIJKLMNOPQRSTUVWXYZ0123456789
, ± ° ½ § ¶ ¤] ^ 3 2 " = ' : . ? _ % , # / - [;) * \$ & ! + (. ¼ @

RHETORIC (10 pitch)

ABCDEFGHIJKLMNOPQRSTUVWXYZABCDEFGHIJKLMNOPQRSTUVWXYZ0123456789
, ± ° ½ § ¶ ¤] ^ 3 2 " = ' : . ? _ % , # / - [;) * \$ & ! + (. ¼ @

GOTHIC 15

abcdefghijklmnopqrstuvwxyzABCDEFGHIJKLMNOPQRSTUVWXYZ0123456789
, ± ° ½ § ¶ ¤] ^ 3 2 " = ' : . ? _ % , # / - [;) * \$ & ! + (. ¼ @

APPENDIX E. IBM 5218/IBM 5228 PRINTWHEEL PRINTER PRINTWHEEL DESCRIPTIONS

The following chart lists the printwheel type styles currently available.

Use this chart when changing the program diskette to match your primary printwheel. For practice using this chart, refer to "Topic 24. Changing Your Program Diskette to Match Your Printwheel and Keyboard Number," in the IBM Displaywriter System Operator Training Book 2 - Selectable Topics.

Type Style Name	Pitch	Type Style ID Number
Artisan	10	013
Boldface	PSM	159
Courier 10	10	011
Courier 12	12	085
Essay	PSM	160
Gothic	15	719
Letter Gothic	12	087
Modern	PSM	158
Prestige	15	655
Prestige Elite	12	086
Prestige Pica	10	012
Rhetoric	10	736
Symbol 1*	--	637
Symbol 2*	--	734
Symbol 3*	--	735

*The Symbol printwheels do not require a special type style number. (You can use the type style number currently in the LINE FORMAT menu.)

Foreign language printwheels are also available in various type styles.

This page is intentionally left blank.

APPENDIX F. IBM 5218/IBM 5228 PRINTWHEEL PRINTER MESSAGE DESCRIPTIONS

The following chart lists the message numbers and the corresponding type style names and re-order numbers needed when the message, Put on Printer Element XXX-XXX, appears on the display.

Message	Type Style Name	Re-order Number	Pitch
011-001	Courier 10	1439511	10
012-001	Prestige Pica	1439503	10
013-001	Artisan 10	1439520	10
085-001	Courier 12	1439523	12
086-001	Prestige Elite	1439502	12
087-001	Letter Gothic	1439514	12
158-001	Modern	1439517	PSM
159-001	Boldface	1439504	PSM
160-001	Essay	1439526	PSM
734-001	Symbol 2	1439734	
637-001	Symbol 1	1439637	
655-001	Prestige	1439655	15
719-001	Gothic	1439719	15
735-001	Symbol 3	1439735	
736-001	Rhetoric	1439736	10

For ease in determining the pitch of your printwheels, all 10-pitch printwheels are red, all 12-pitch printwheels are green, all 15-pitch printwheels are blue, and all PSM (proportional) printwheels are orange.

This page is intentionally left blank.

APPENDIX G. IBM 5218/IBM 5228 PRINTWHEEL PRINTER PAPER SPECIFICATIONS

TRACTOR FEED PAPER TYPES

Continuous-form paper can be either single-part (without carbon copies) or multi-part (with carbon copies).

Note: When using multi-part, continuous-form, pin-feed paper, all "plies" must be "positively" fastened at one edge so that they do not separate before reaching the exit tractor drive pins. "Positive" fastening refers to the optional, secure fastening method available from major forms-manufacturing companies.

TRACTOR FEED PAPER SIZES

Width: 50.8 mm (2 inches) to 368.3 mm (14.5 inches) pin to pin (5218).
50.8 mm (2 inches) to 445 mm (17.5 inches) pin to pin (5228).

Weight: Single-part Forms: 60 to 90 g/m² (16 to 24 pounds). Multipart forms: individual plies of 45 to 90 g/m² (12-24 pounds).

Copies: Maximum number of copies is one original and five copies (5218). The 5228 is limited to one original and two copies if the forms width exceeds 14.5 inches.

Thickness: Maximum thickness for an original and copies, including carbons is 0.6 mm (0.024 inches).

Note: Multi-part forms should be tested before quantity ordering since some manufactured five- and six-part forms may exceed the maximum allowable thickness and may cause paper feeding problems.

SHEET-FEED RECOMMENDED PAPER COMPOSITION

Plain bond paper of either:

- No. 1 sulphite (100% chemical wood pulp)
- 25% cotton content
- 50% cotton content
- 100% cotton content
- Paper made from recycled office paper

Note: Supplies and environment play an important role in proper machine operation. You are encouraged to work with your paper vendor to select acceptable paper for your application. Supplies should be stored in the same environment as the machine. If this is impractical, it is recommended that a small supply of paper be stored in the operating environment for at least 24 hours prior to the use. Proper paper selection and environmental conditions will help provide you with optimum machine performance.

SHEET-FEED PAPER WEIGHTS

The following range of paper weights can be used in the sheet-feed devices:

- 60 to 90 g/m² (16 to 24 pounds)

Note: For optimum results, 75 g/m² (20 pound), 25% to 50% cotton content, plain bond paper is recommended.

SHEET FEED PAPER SIZES

The following paper sizes can be fed:

148 mm x 210 mm (5.83 in. x 8.27 in.) Fed lengthwise only
178 mm x 267 mm (7.0 in. x 10.5 in.) Fed lengthwise only
182 mm x 257 mm (7.17 in. x 10.12 in.) Fed lengthwise only
184 mm x 267 mm (7.25 in. x 10.5 in.) Fed lengthwise only
191 mm x 267 mm (7.5 in. x 10.5 in.) Fed lengthwise only
197 mm x 273 mm (7.75 in. x 10.75 in.)
203 mm x 254 mm (8.0 in. x 10.0 in.)
203 mm x 267 mm (8.0 in. x 10.5 in.)
203 mm x 330 mm (8.0 in. x 13.0 in.) Fed lengthwise only
210 mm x 297 mm (8.27 in. x 11.69 in.)
216 mm x 279 mm (8.5 in. x 11.0 in.)
216 mm x 330 mm (8.5 in. x 13.0 in.) Fed lengthwise only
216 mm x 356 mm (8.5 in. x 14.0 in.) Fed lengthwise only
250 mm x 353 mm (9.84 in. x 13.9 in.) Fed lengthwise only
257 mm x 364 mm (10.12 in. x 14.33 in.) Fed lengthwise only

SHEET-FEED PAPER LIMITATIONS

The following paper supplies cannot be used reliably in the sheet-feed devices and may cause paper jams:

- Coated paper
- Vellums
- Highly sized erasable bond paper
- Synthetic paper
- Transluents
- Multi-sheet forms (bound or unbound)
- Peel-off pressure-sensitive labels
- Some chemically treated paper (for example, paper used to make copies without carbon paper)
- Pre-printed forms that require a high degree of registration for character location
- Envelopes
- Card Stock
- Some pre-printed papers where the printing process results in either introducing chemicals which contaminate the feed mechanism components or change the paper frictional characteristics
- Paper with edges bonded together
- Dark colored paper.

SHEET-FEED PAPER CONDITIONS

Paper in unsatisfactory condition will not feed reliably and may cause paper jams. The following can affect the use of the sheet-feed devices:

- Mixtures of paper sizes, types, or composition in the paper trays
- Paper embossed (raised lettering) over 0.5 mm (.020 in.)
- Poorly cut edges
- Curl in excess of 3.0 mm (0.118 in.)
- Rough or gummed surfaces
- Paper excessively damp or dry
- Dark colored paper
- Paper containing holes, perforations, cutouts or windows
- Folded paper
- Multi-part paper
- Paper with edges bonded together.

PAPER STORAGE

Paper should be stored flat in the original package, and it should be removed from the paper trays at the end of the day.

For optimum operation, paper should be preconditioned not less than 24 hours (preferably in an open box) in the same room as the printer.

FRONT EXIT SHEET FEED RECOMMENDED ENVELOPE WEIGHTS

The following range of envelope weights can be used in the Front Exit Sheet Feed.

- 60-90 gm/m² (16-24 lb.) bond

Note: For optimum results, 75 gm/m² (20 lb.) of sulfite or 25% cotton content plain bond is recommended.

FRONT EXIT SHEET FEED ENVELOPE SIZES

Number 7 3/4	98.4 mm x 190.5 mm (3.875 in. x 7.5 in.)
Number 9	98.4 mm x 225.4 mm (3.875 in. x 8.875 in.)
Number 10	104.8 mm x 241.3 mm (4.125 in. x 9.5 in.)

Envelopes ranges are:

98.4 mm to 114.3 mm (3.875 in. to 4.5 in.) in width
190.5 mm to 241.3 mm (7.5 in. to 9.5 in.) in length

FRONT EXIT SHEET ENVELOPE LIMITATIONS

- Envelopes with windows, holes, perforations, cutouts, or deep embossing
- Envelopes with side flaps
- Envelopes with flaps that extend more than 60 mm (2.36 in.) beyond the fold line.

FRONT EXIT SHEET ENVELOPE CONDITIONS

- Envelopes that are stuck together
- Envelopes that will not stack flat
- Envelopes that are damaged or bent so that they are interlocked.

ENVELOPE STORAGE

Envelopes should be stored in their original box, and the box should be stored on its end so that the envelopes lay flat. This minimizes envelope curl. At the end of the day envelopes should be removed from the front exit sheet feed and stored in their original box.

For optimum operation, envelopes should be preconditioned not less than 24 hours (preferably in an open box) in the same room as the printer.

PAPER SPECIFICATION FOR MANUAL INSERTION

Paper meeting the following specifications is acceptable for use in the IBM 5218/IBM 5228 Printwheel Printer. Use of supplies outside of these specifications may result in unsatisfactory printing or feeding.

Single Sheets

Width: 80-392 mm (3.15-15.4 inches) (5218)
80-483 mm (3.15-19 inches) (5228)

Weight: 60-90 g/m² (16 to 24 pound bond)

Bound Forms with up to 6 parts

Width: 80-392 mm (3.15-15.4 inches)

Weight: 34-90 g/m² (9-24 pounds bond)

Total Maximum Thickness Including Carbons: 0.63 mm (0.025 inches)

Cut Sheet with up to 5 carbons

Width: 80-392 mm (3.15-15.4 inches)

Weight: 34-90 g/m² (9-24 pound bond)

Total Maximum Thickness Including Carbons: 0.63 mm (0.025 inches)

Other Applications

When inserting envelopes, self-adhesive labels, cards, etc., the appropriate width, thickness, and weight requirements for single sheet or multiple sheet forms apply. Envelopes with gummed flaps are permitted. Do not use envelopes with metal or string parts.

You may use this form to communicate your comments about this publication, its organization, or subject matter, with the understanding that IBM may use or distribute whatever information you supply in any way it believes appropriate without incurring any obligation to you. Your comments will be sent to the author's department for whatever review and action, if any, are deemed appropriate.

Note: *Copies of IBM publications are not stocked at the location to which this form is addressed. Please direct any requests for copies of publications, or for assistance in using your IBM system, to your IBM representative or to the IBM branch office serving your locality.*

Possible topics for comment are:

Clarity Accuracy Completeness Organization Coding Retrieval Legibility

If you wish a reply, give your name, company, mailing address, and date:

Note: Staples can cause problems with automated mail sorting equipment.
Please use pressure sensitive or other gummed tape to seal this form.

What is your occupation? _____

Number of latest Newsletter associated with this publication: _____

Thank you for your cooperation. No postage stamp necessary if mailed in the U.S.A. (Elsewhere, an IBM office or representative will be happy to forward your comments or you may mail directly to the address in the Edition Notice on the back of the title page.)

Reader's Comment Form

..... Cut or Fold Along Line

Fold and tape

Please Do Not Staple

Fold and tape



NO POSTAGE
NECESSARY
IF MAILED
IN THE
UNITED STATES

BUSINESS REPLY MAIL
FIRST CLASS PERMIT NO. 40 ARMONK, NEW YORK

POSTAGE WILL BE PAID BY ADDRESSEE

International Business Machines Corporation
Department 506, Building 998
11400 Burnet Rd.
Austin, Texas 78758

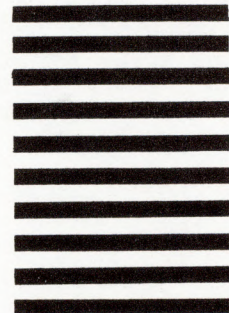

IBM Displaywriter System Printer Guide Printed in USA S544-0861-4

Fold and tape

Please Do Not Staple

Fold and tape



S544-0861-4
PN 6081974

IBM Displaywriter System Guide Printed in USA S544-0861-4

