

RENEWAL PARTS

I. Ordering Instructions

1. Always specify the complete nameplate data.
2. Specify the quantity, catalog number, description of each part ordered, and this publication number.
3. Standard hardware, such as screws, bolts, nuts, washers, etc., is listed as a group under the "Miscellaneous Section".
4. Parts can be ordered from the General Electric Company, Schenectady Instrumentation Service, Building 28-5, 1 River Road, Schenectady, New York 12305 or General Electric Company, Data Communication Products Department, Waynesboro, Virginia 22980.

II. Major Sections and Assemblies

<u>Section</u>	<u>Title</u>	<u>Page</u>
0	Miscellaneous	0-1 through 0-7
1	Top-Bottom Cover	1-1 through 1-5
2	Keyboard Assembly	2-1 through 2-6
3	Control Panel Assembly	3-1 through 3-7
4	Hammer and Print Belt Assembly	4-1 through 4-12
5	Frame Assembly	5-1 through 5-16
6	Bustle Assembly	6-1 through 6-6

This illustrated Parts List is for the TermiNet 300 Printer; Keyboard Send Receive (KSR), and Receive Only (RO) versions. All three Models of each version; A, B, and C are covered.

**SECTION 0
MISCELLANEOUS ITEMS
(KITS AND ACCESSORIES)**

<u>CODE</u>	<u>FIGURE</u>	<u>PART NO.</u>	<u>DESCRIPTION</u>	<u>KSR</u>	<u>RO</u>	<u>A</u>	<u>B</u>	<u>C</u>
0015		44A410318-G01	Answerback Kit PCB Not Included	X	X	X	X	X
0016	1-1	44C414179-001	Anti-Curl Device	X	X	X	X	X
0017		44A410579-G01	Board Conversion Kit, HDC	X	X	X	X	X
0018	2-	3S3020AA000A1	Cassette Tape Accessory	X		X	X	X
0019		44A410516-G01	Clutch Kit, Linefeed	X		X		
0020	3-1	44C414174-G01	Copy Stand	X		X	X	X
0021	4-1	44C414146-G01	Handler, External Paper	X	X	X	X	X
0022	5-1	44A410395-G01	Holder, Wide Roll Paper	X	X	X	X	X
0023		44A410317-G01	Horizontal Tab Kit	X	X	X	X	
0024		44A410317-G03	Horizontal Tab Kit	X	X			X
0025		44A410633-G01	Jumper Kit, Diode	X	X	X	X	X
0026		44A410591-G01	Modem, Integral-300 Baud	X	X		X	
0027		44A410591-G02	Modem, Integral-300 Baud	X	X			X
0028	6-	44C414195-G01	Numeric Cluster	X				X
0029		44A410316-G06	Platen Kit (118) Friction to Pin Feed	X	X	X	X	X
0030		44A410316-G07	Platen Kit (75) Friction to Pin Feed	X	X	X	X	X
0031		44A410316-G10	Platen Kit (80) Friction to Pin Feed	X	X	X	X	X
0032		44A410316-G12	Platen Kit (A11) Pin Feed to Friction	X	X	X	X	X
0033		44C414110-G01	Vertical Tab and Form Feed Kit -11" Form	X	X		X	
0034		44C414110-G02	Vertical Tab and Form Feed Kit -8" Form	X	X		X	
0035		44C414110-G03	Vertical Tab and Form Feed Kit -11" Form	X	X			X
0036		44C414110-G04	Vertical Tab and Form Feed Kit -8" Form	X	X			X

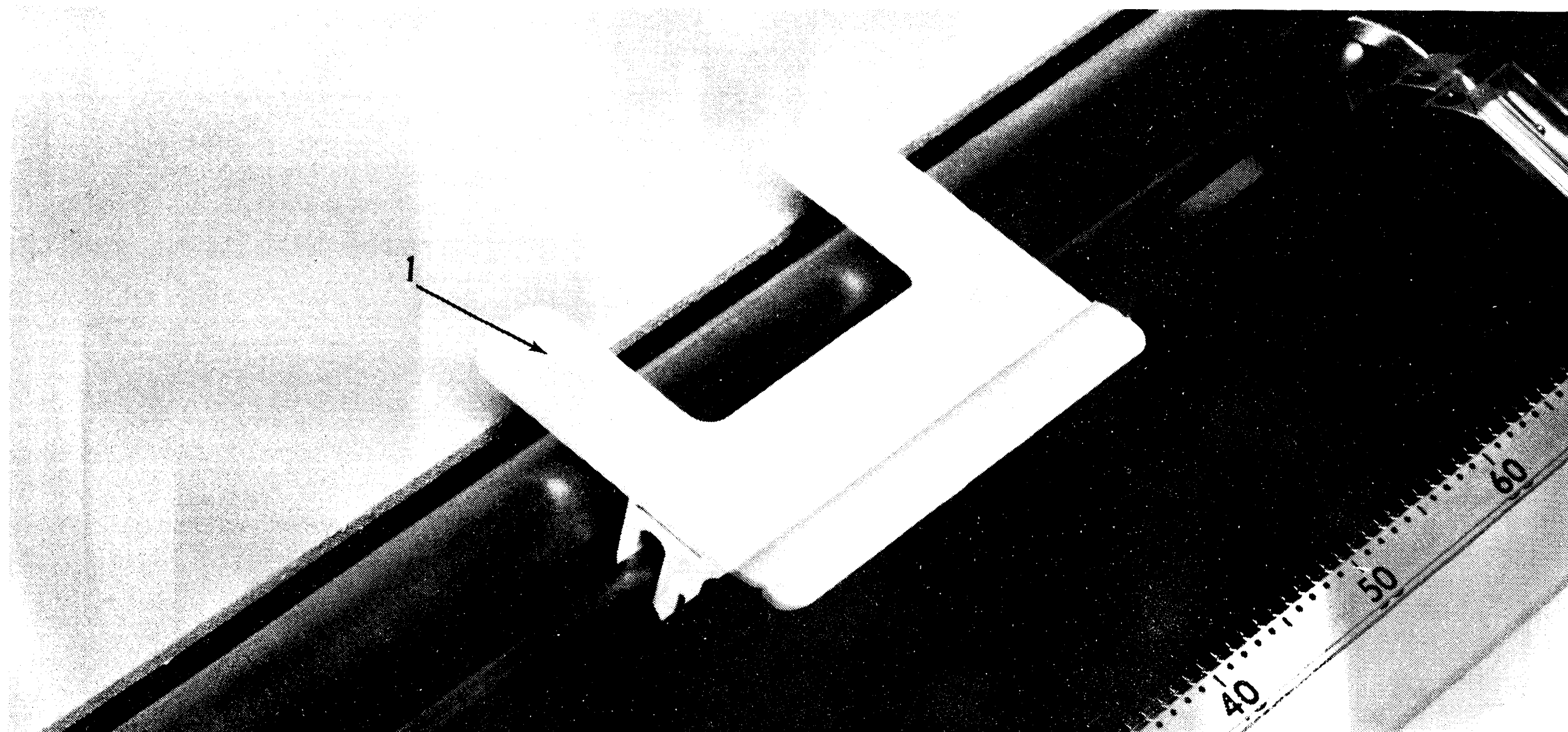

Anti-Curl Device

Figure 1

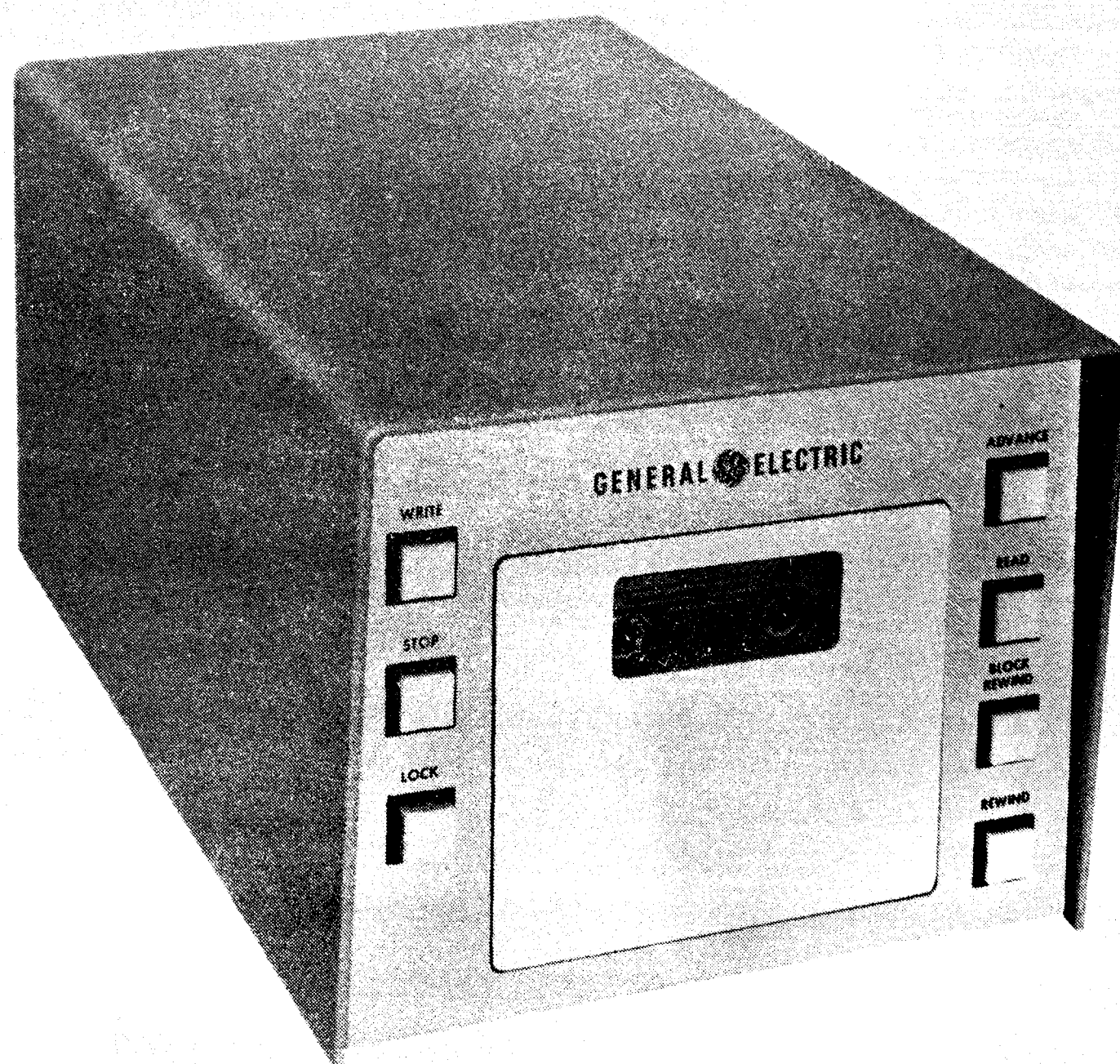

Magnetic Tape Cassette Accessory
Figure 2



Copy Stand
Figure 3

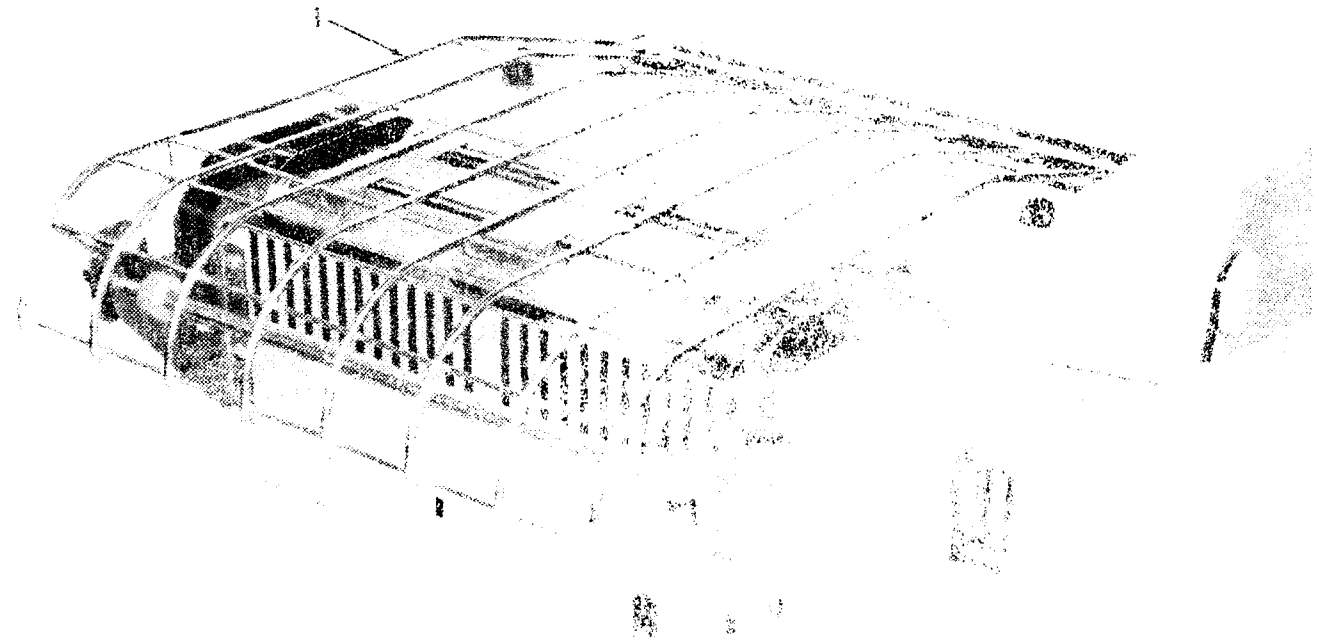

External Paper Holder
Figure 4

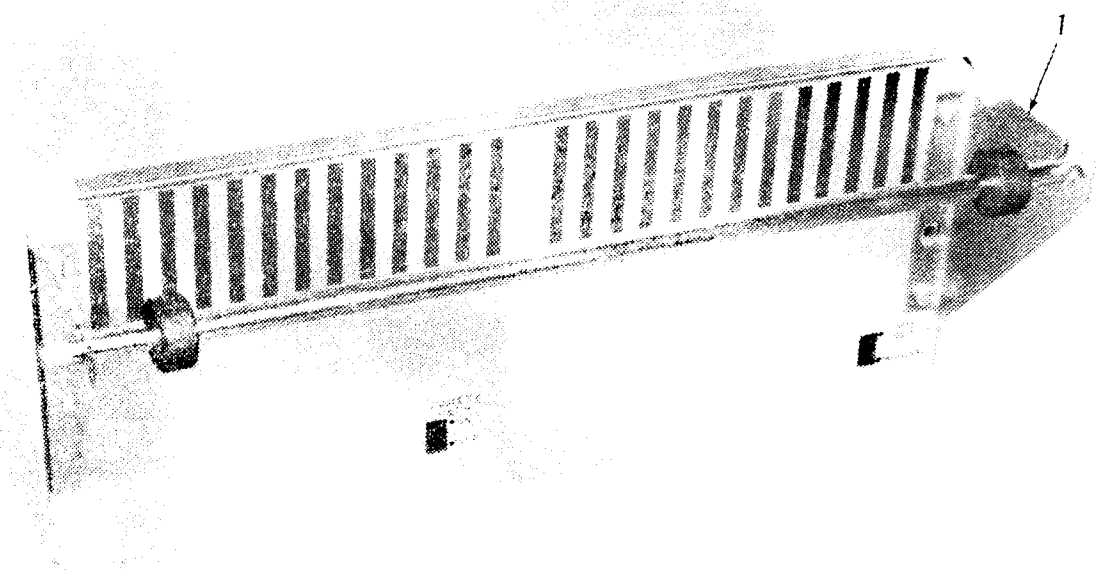

Wide Roll Paper Holder
Figure 5

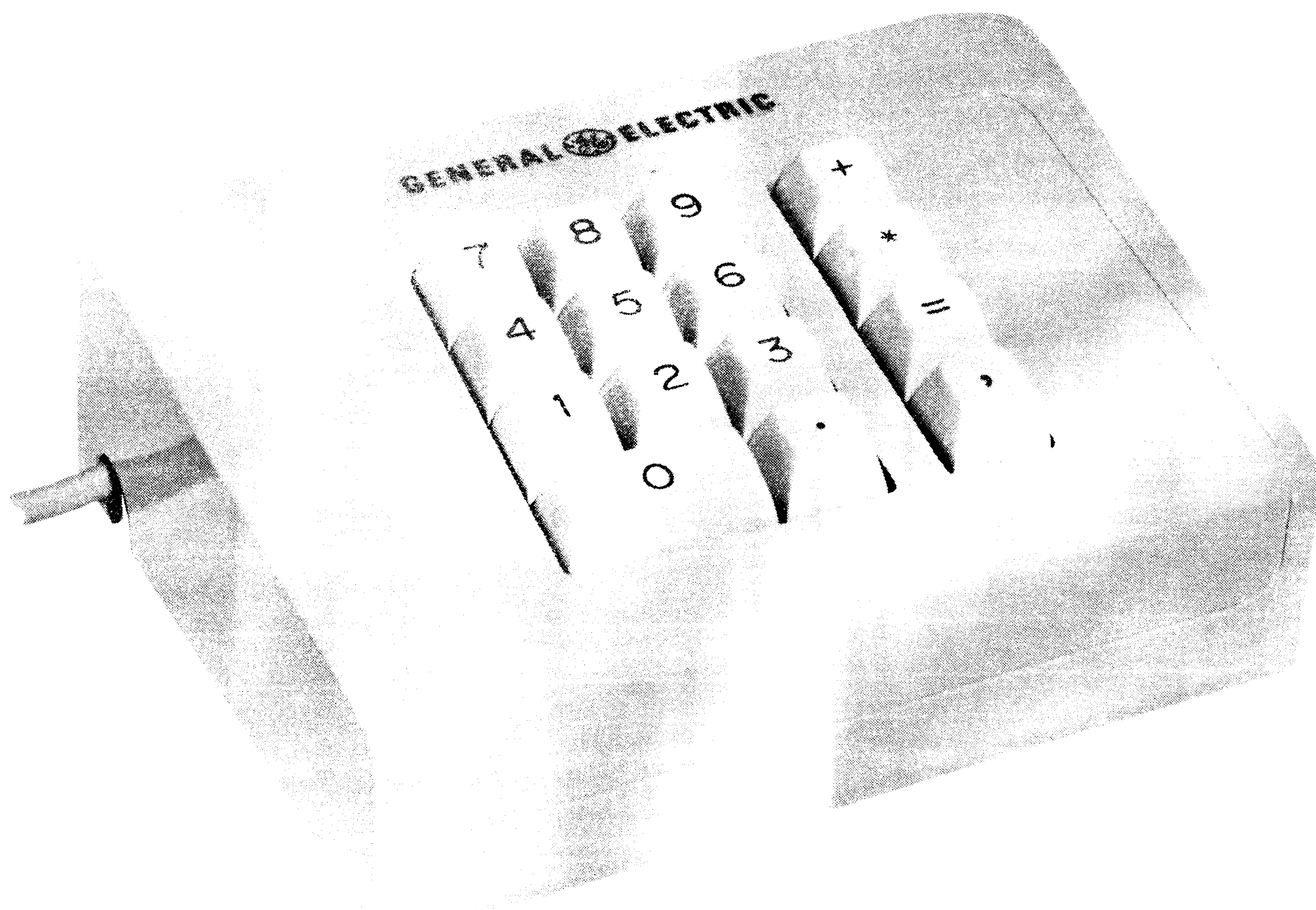

Numeric Cluster
Figure 6

(PARTS)

CODE	FIGURE	PART NO.	DESCRIPTION	KSR	RO	A	B
0014		44B412349-G01	Cable, Dataset	X		X	X
0045		44B412434-G01	Cable, Dataset		X		X
0046		44B412497-G01	Cable, Dataset	X			X
0049		44B412498-G01	Cable, Dataset		X		X
0012		44A417020-001	Cable, Input Power	X	X	X	X
0013		44A417336-001	Cover, Vinyl Dust	X		X	X
0052		44A417336-003	Cover, Vinyl Dust		X	X	X
0054	7-1	44A417367-001	Discs (Pkg. of 25)- for 11" VT-FF Option	X	X		X
0055		44A417393-001	Discs (Pkg. of 25)- for 8" VT-FF Option	X	X		X
0011		44A410466-G01	Fuses-Large Assortment	X	X	X	X
0039		44A410466-G02	Fuses-Small Assortment	X	X	X	X
0040		44A410466-G03	Fuses-Small Assortment	X	X		
0002		44A410320-G01	Hardware Assortment	X	X	X	X
0041		44A410320-G02	Hardware Assortment	X	X		
0056	8-1	44B412374-G01	Punch and Base Assembly - for 11" VT-FF Option	X	X		X
0057		44B412486-G01	Punch and Base Assembly - for 8" VT-FF Option	X	X		
0007		44A417013-002	Ribbon and Spools	X	X	X	
0058		44B412247-G02	Spare Parts Kit	X		X	
0059		44B412247-G04	Spare Parts Kit	X			
0060		44B412247-G05	Spare Parts Kit		X		
0061		44B412247-G06	Spare Parts Kit (Incl. ASR)	X			
0062		44B412247-G11	Spare Parts Kit (Incl. Special Tools)	X		X	
0063		44B412247-G12	Spare Parts Kit (Incl. ASR and Special Tools)	X			
0064		44B412247-G14	Spare Parts Kit (Incl. Special Tools)		X		
0001		44A410321-G01	Spring and Shim Assortment	X	X	X	X

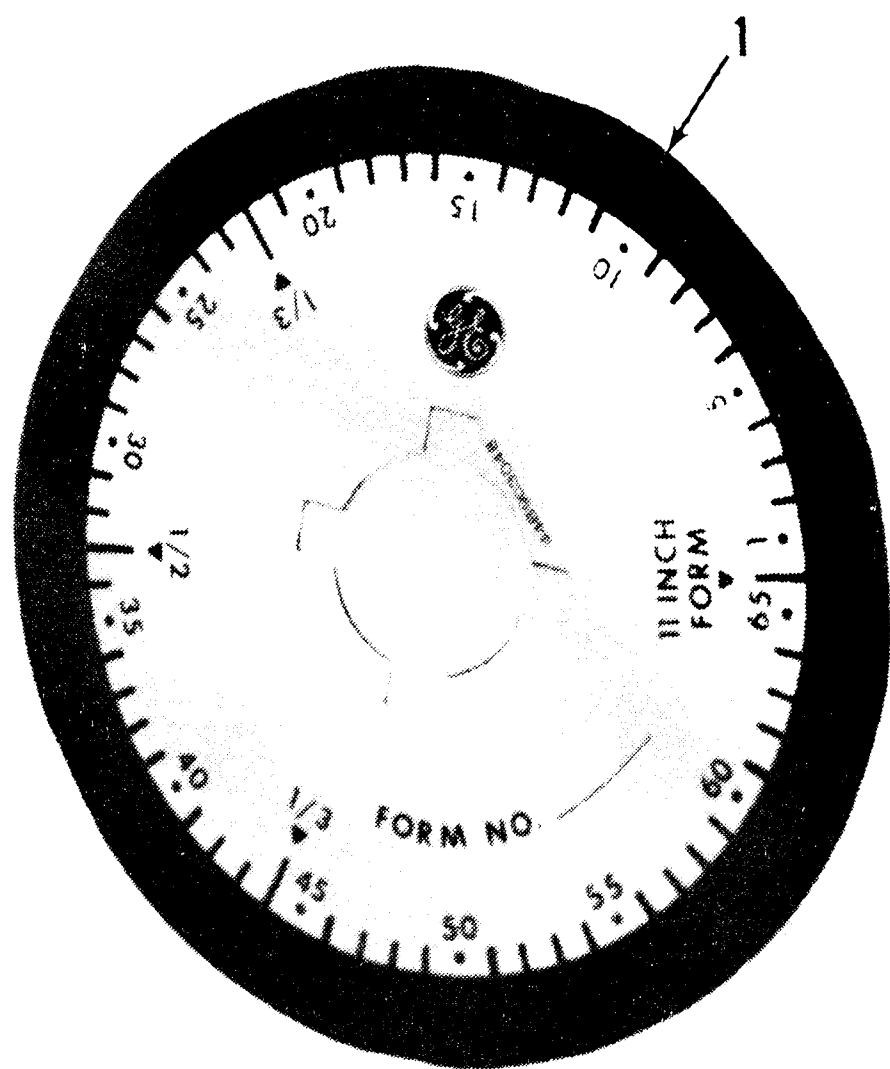

VT-FF 11" Paper Disc

Figure 7

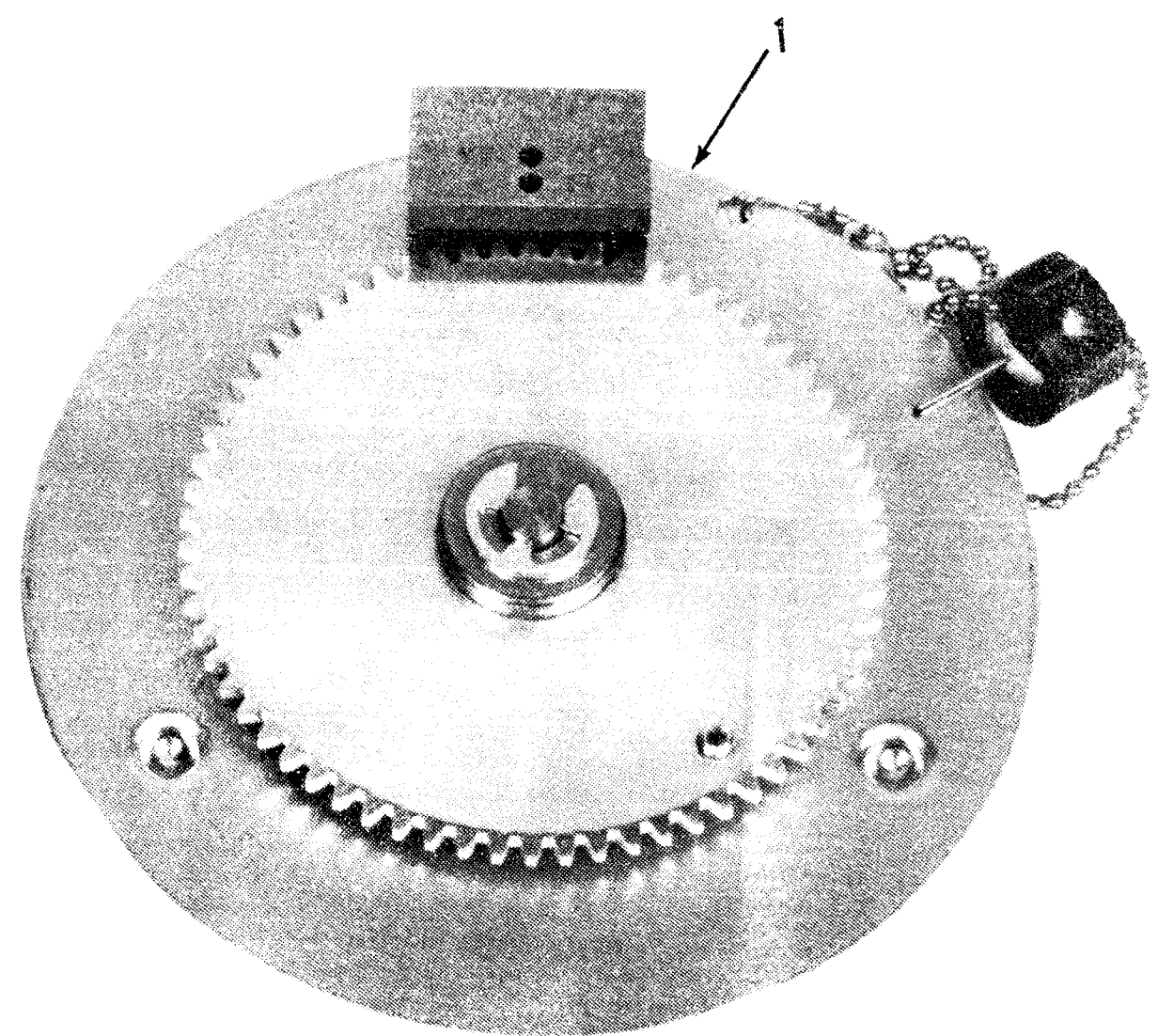

VT-FF 11" Punch

Figure 8

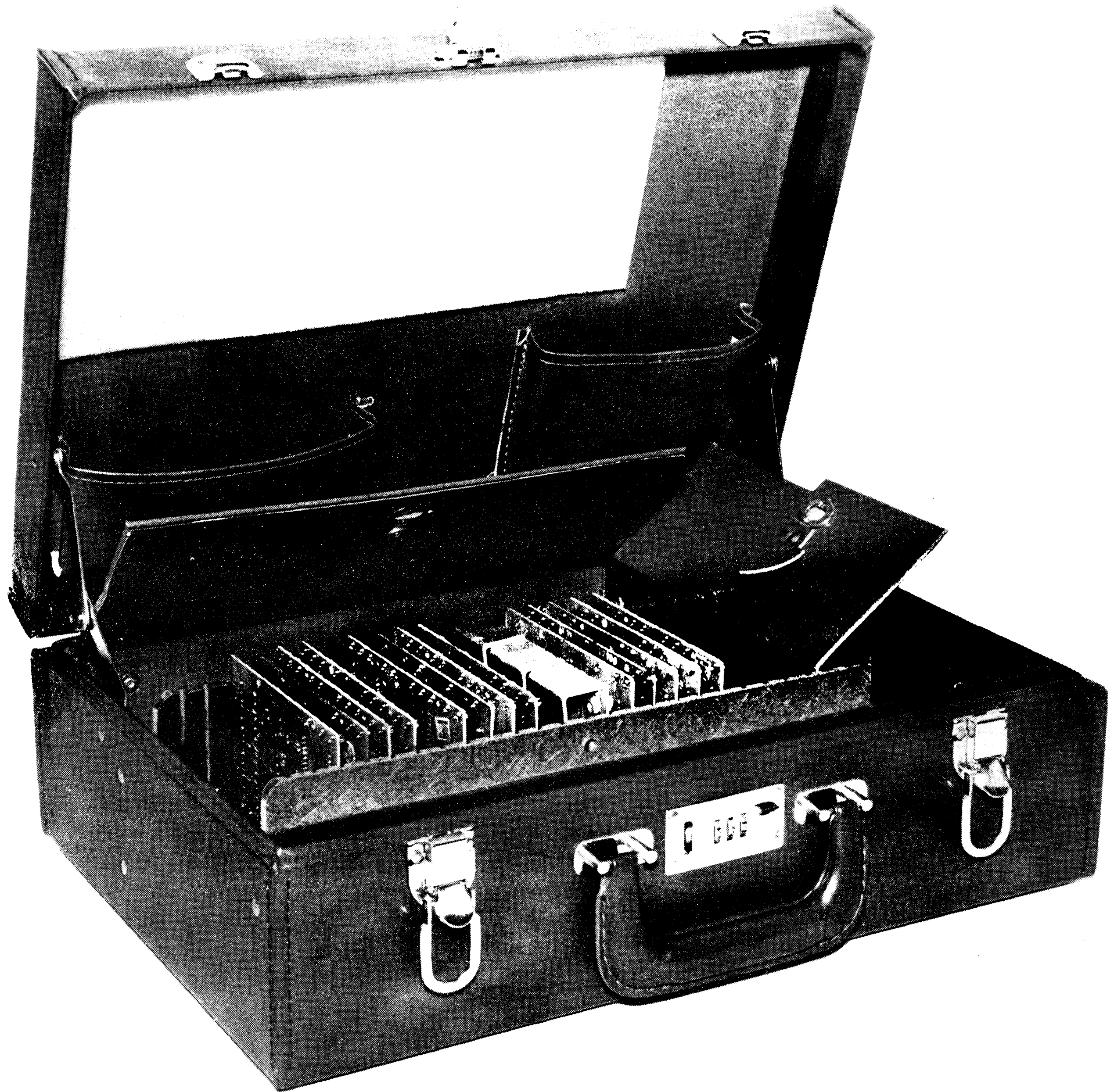

Carrying Case
Figure 16

SECTION 1
TOP BOTTOM COVER

<u>CODE</u>	<u>FIGURE</u>	<u>PART NO.</u>	<u>DESCRIPTION</u>	<u>KSR</u>	<u>RO</u>	<u>A</u>	<u>B</u>	<u>C</u>
1303	19-1	44A410144-001	Bracket, Interlock Switch	X	X	X	X	X
1206	18-1	44A410130-002	Bracket, Left Latch	X	X	X	X	
1214	20-1	44A410660-002	Bracket, Left Latch	X	X			X
1205	18-2	44A410130-001	Bracket, Right Latch	X	X	X	X	
1213	20-2	44A410660-001	Bracket, Right Latch	X	X			X
1201	19-2	44B412191-G01	Cable TXP Input	X	X	X	X	
1216	21-1	44B412494-G01	Cable, TXPC Input	X	X			X
1211	18-3	44C414105-G01	Cover Asm., Bottom	X	X		X	
1212	20-3	44C414168-G01	Cover Asm., Bottom	X	X			X
1200		44C414036-G01	Cover Asm., Bottom	X	X	X		
1306	17-1	44B412243-G01	Cover, Front		X	X	X	X
1300	19/21	44B412054-001	Cover, Interlock Switch	X	X	X	X	X
1210		44A410972-001	Cover, R and P Connector	X	X		X	
1100	18-4	44D415522-G01	Cover Asm., Top	X	X	X	X	
1103	20-4	44D415583-G01	Cover Asm., Top	X	X			X
1000	18-		Cover Asm., Top-Bottom	X	X		X	
1001	20-		Cover Asm., Top-Bottom	X	X			X
1209	18-5	44A417028-003	Feet, Rubber	X	X	X	X	
1215		44A333474-003	Feet, Rubber	X	X			X
1207	19-3	44A319863-001	Fuse Holder	X	X	X	X	
1208		K9774740P5	Fuse (2A) Input	X	X	X	X	
1101	18-6	44B412084-G01	Hinge Asm., Left	X	X	X	X	X
1102	18-7	44B412084-G02	Hinge Asm., Right	X	X	X	X	X
1302	19-4	44A410218-001	Latch, Switch Lock	X	X	X	X	X
1104	20-5	44A410597-001	Latch, Pin	X	X			X
1002	19-5	44A417019-001	Receptacle, AC	X	X	X	X	X
1204	18-8	44A410131-001	Screw, Shoulder	X	X	X	X	X
1203	18-9	44A410405-001	Strap, Ground	X	X	X	X	X
1305	18-10	44B412231-002	Support, Bustle Cover (Lf.)	X	X	X	X	X
1304	18-11	44B412231-001	Support, Bustle Cover (Rt.)	X	X	X	X	X
1301	19-6	44A417036-001	Switch, Cover Interlock	X	X	X	X	X
1003	19-7	44A417037-001	Switch, Power	X	X	X	X	X



TerminiNet 300 Data Communication Printer
("Receive Only" Version)

Figure 17

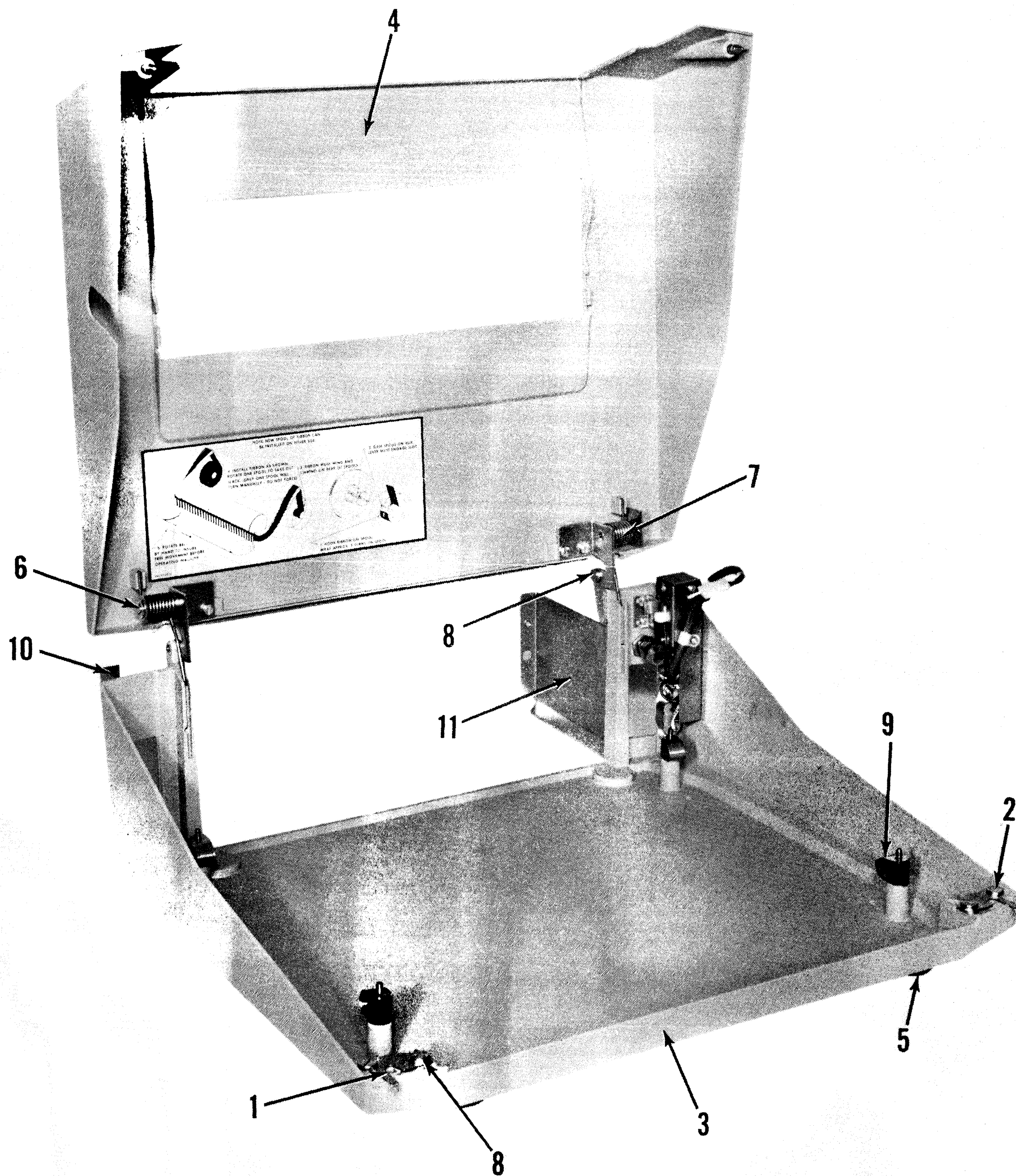

Top-Bottom Cover - Model B
Figure 18

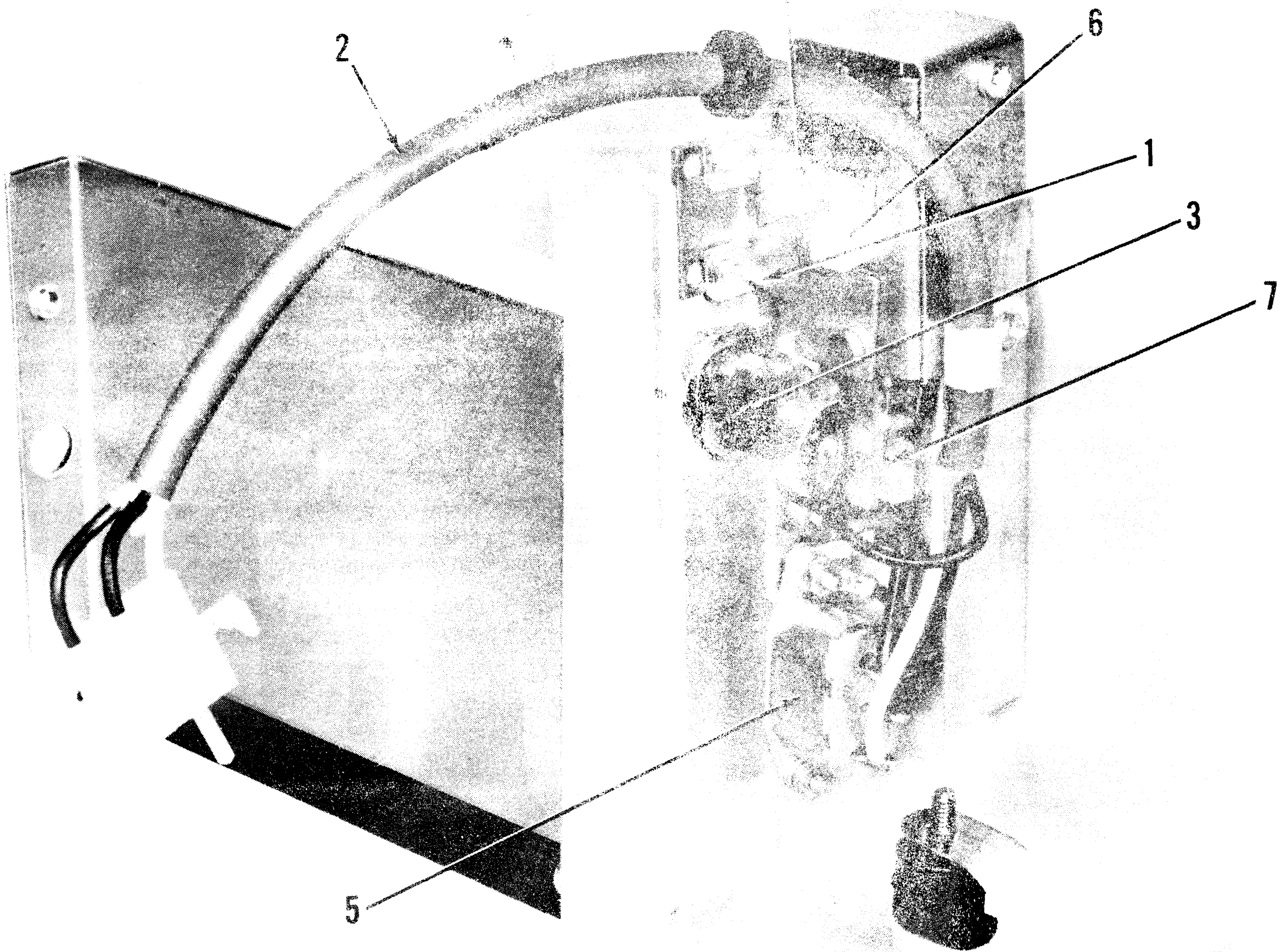

Cover Interlock - Model 1000
Plan 1000

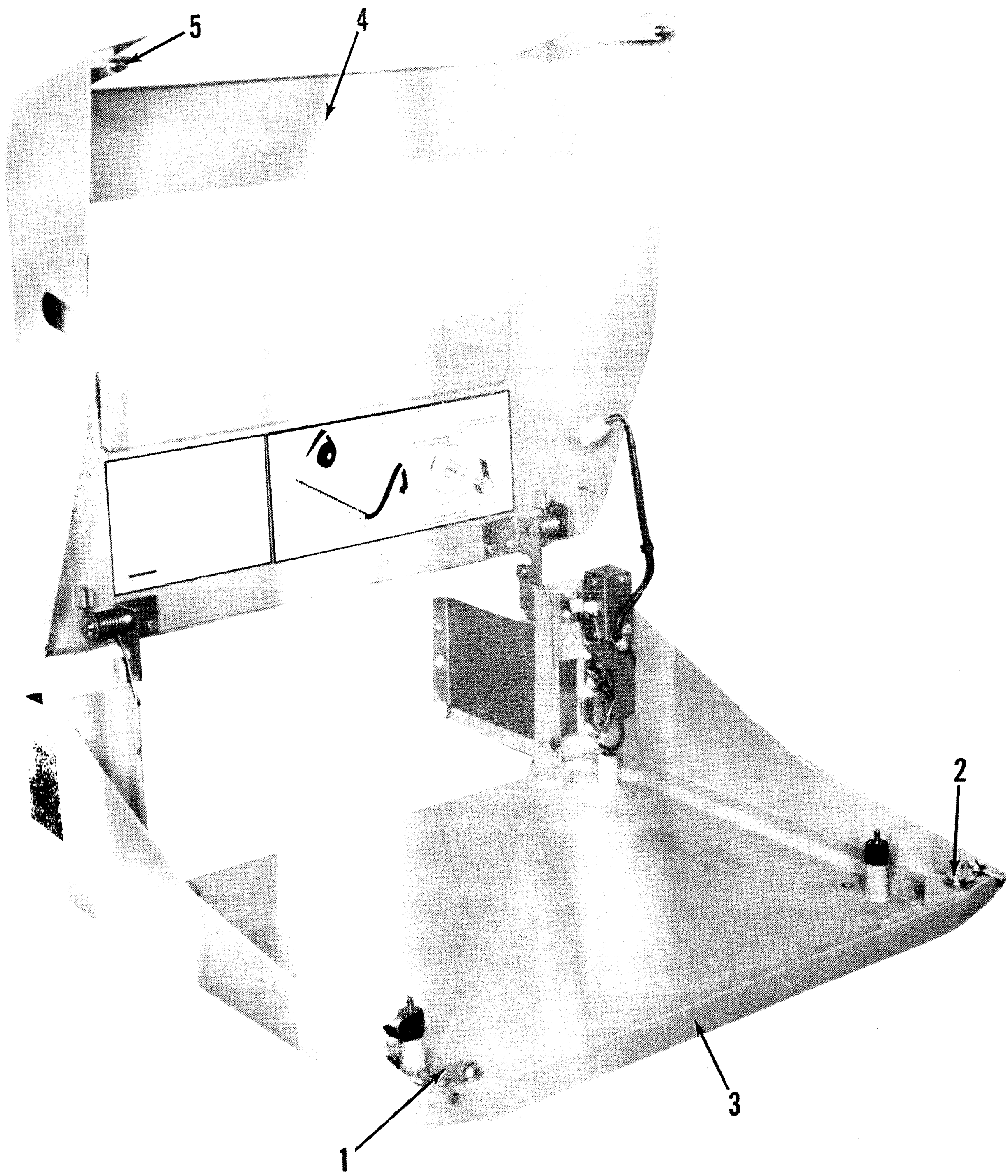

Top-Bottom Cover - Model C
Figure 20

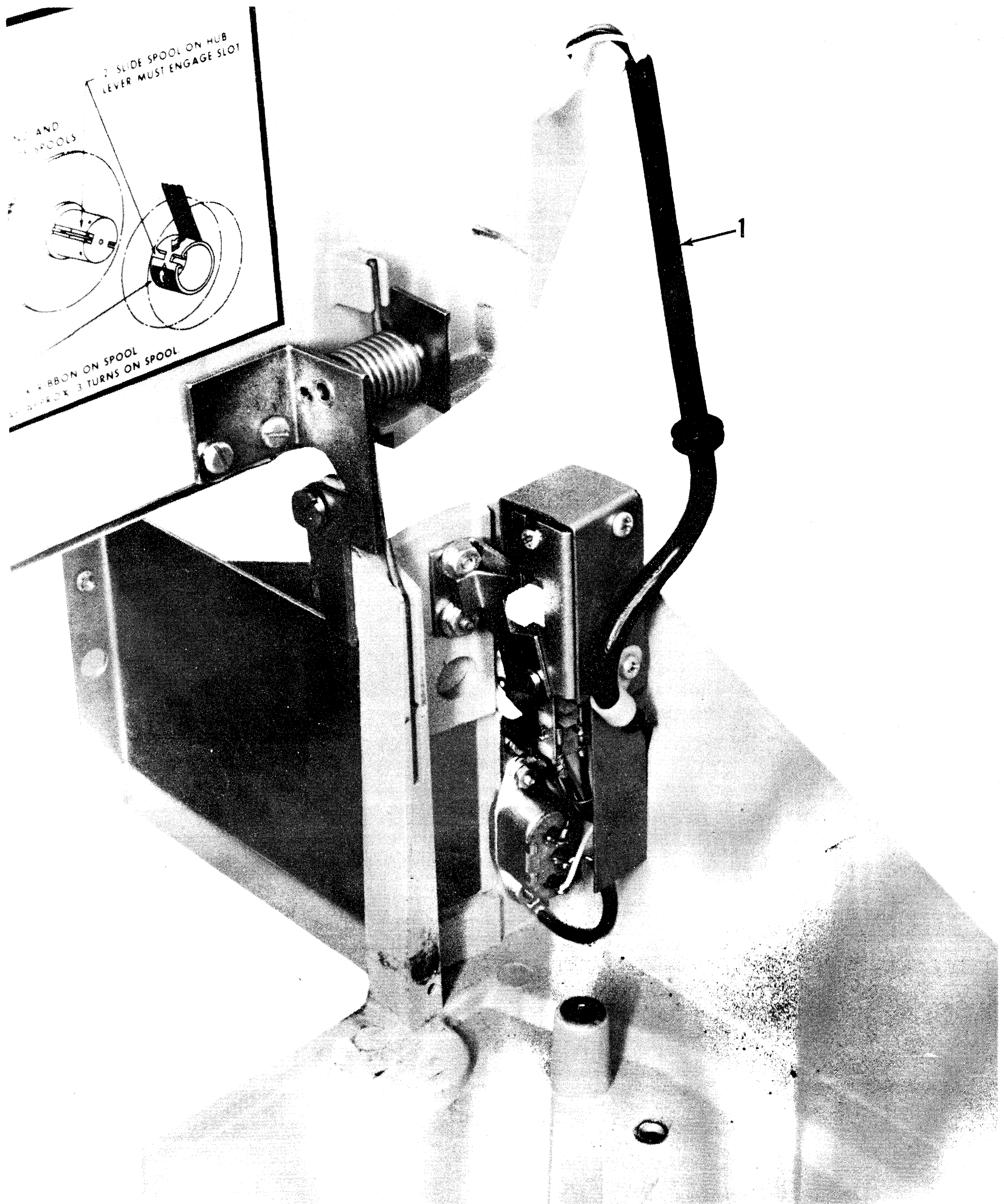

Cover Interlock - Model C

Figure 21



SECTION 2 KEYBOARD ASSEMBLY

<u>CODE</u>	<u>FIGURE</u>	<u>PART NO.</u>	<u>DESCRIPTION</u>	<u>KSR</u>	<u>RO</u>	<u>A</u>	<u>B</u>	<u>C</u>
2202	22-7	44B412016-G01	Angle, Spring Support	X		X	X	
2215	22-2	44A410142-001	Angle, Support	X		X	X	
2214	22-3	44A410096-001	Bail	X		X	X	
2220	24-1	44A410656-001	Bail	X				X
2212	22-4	44A410039-001	Bushing, Bail	X		X	X	
2219	24-2	44A410609-001	Bushing, Bail	X				X
2304	25-1	44C414155-001	Cap, Switch "Auto LF"	X				X
2305	25-2	44C414155-002	Cap, Switch "ALL CAPS"	X				X
2004	22-5	44D415512-003	Casting, Keyboard	X		X	X	
2007	24-3	44C414175-001	Casting, Keyboard	X				X
2003	22-6	44B412409-G02	Cover Assembly, Bottom	X		X	X	X
2002	22-1	44B412056-001	Cover, Dust	X		X	X	X
2008	22-8	44A410061-001	Cushion	X		X	X	X
2203	22-9	44A410376-G01	Ferrite Clip, Shimmed (Qty. 5)	X		X	X	X
2204	22-10	44A410016-G01	Ferrite and Clip, Upper (Qty. 57)	X		X	X	X
2301	22-11	44A355938-001	Ferrite U Core, Lower (Qty. 62)	X		X	X	X
2222	24-4	44A410590-G01	Guide, Back	X				X
2225	22-12	44A410346-G01	Guide, Back	X		X	X	
2201	22-13	44A410585-G01	Guide Asm., Front	X		X	X	X
2208	27-1	44A410036-G01	Keybar, 1st Row	X		X	X	X
2211	27-2	44A410038-G01	Keybar, 2nd Row	X		X	X	X
2207	27-3	44A410035-G01	Keybar, 3rd Row	X		X	X	X
2206	27-4	44A410034-G01	Keybar, 4th Row	X		X	X	X
2209	27-5	44A410037-G01	Keybar, Space Left	X		X	X	
2217		44A410584-G01	Keybar, Space Left	X				X
2210	27-6	44A410037-G02	Keybar, Space Right	X		X	X	
2218		44A410584-G02	Keybar, Space Right	X				X
2000	22/23	44E416502-G01	Keyboard Asm.	X		X	X	
2005	24/25/26	44D415585-G01	Keyboard Asm.	X				X
2009		44E416502-G02	Keyboard Asm. (1)	X		X	X	
2010		44D415585-G02	Keyboard Asm. (1)	X				X
2101	23-1	44D415502-001	Keybutton A	X		X	X	X
2102	*	44D415502-002	Keybutton B	X		X	X	X
2103	*	44D415502-003	Keybutton C	X		X	X	X
2104	*	44D415502-004	Keybutton D	X		X	X	X
2105	*	44D415502-005	Keybutton E	X		X	X	X
2106	*	44D415502-006	Keybutton F	X		X	X	X
2107	*	44D415502-007	Keybutton G	X		X	X	X
2108	*	44D415502-008	Keybutton H	X		X	X	X
2109	*	44D415502-009	Keybutton I	X		X	X	X
2110	*	44D415502-010	Keybutton J	X		X	X	X
2111	*	44D415502-011	Keybutton K	X		X	X	X
2112	*	44D415502-012	Keybutton L	X		X	X	X

1. Keyboard Assembly with square "O" keybutton.

*Shown in Figure 23 without reference number.

<u>CODE</u>	<u>FIGURE</u>	<u>PART NO.</u>	<u>DESCRIPTION</u>	<u>KSR</u>	<u>R/D</u>	<u>A</u>	<u>B</u>	<u>C</u>
2113	*	44D415502-013	Keybutton M	X		X	X	X
2114	*	44D415502-014	Keybutton N	X		X	X	X
2115	*	44D415502-015	Keybutton O	X		X	X	X
2116	*	44D415502-016	Keybutton P	X		X	X	X
2117	*	44D415502-017	Keybutton Q	X		X	X	X
2118	*	44D415502-018	Keybutton R	X		X	X	X
2119	*	44D415502-019	Keybutton S	X		X	X	X
2120	*	44D415502-020	Keybutton T	X		X	X	X
2121	*	44D415502-021	Keybutton U	X		X	X	X
2122	*	44D415502-022	Keybutton V	X		X	X	X
2123	*	44D415502-023	Keybutton W	X		X	X	X
2124	*	44D415502-024	Keybutton X	X		X	X	X
2125	*	44D415502-025	Keybutton Y	X		X	X	X
2126	*	44D415502-026	Keybutton Z	X		X	X	X
2127	*	44D415502-027	Keybutton 1	X		X	X	X
2128	*	44D415502-028	Keybutton 2	X		X	X	X
2129	*	44D415502-029	Keybutton 3	X		X	X	X
2130	*	44D415502-030	Keybutton 4	X		X	X	X
2131	*	44D415502-031	Keybutton 5	X		X	X	X
2132	*	44D415502-032	Keybutton 6	X		X	X	X
2133	*	44D415502-033	Keybutton 7	X		X	X	X
2134	*	44D415502-034	Keybutton 8	X		X	X	X
2135	*	44D415502-035	Keybutton 9	X		X	X	X
2136	*	44D415502-036	Keybutton 0	X		X	X	X
2137	*	44B415502-037	Keybutton =	X		X	X	X
2138	*	44D415502-038	Keybutton -	X		X	X	X
2139	*	44D415502-039	Keybutton @	X		X	X	X
2140	*	44D415502-040	Keybutton +;	X		X	X	X
2141	*	44D415502-041	Keybutton *:	X		X	X	X
2142	*	44D415502-042	Keybutton <,	X		X	X	X
2143	*	44D415502-043	Keybutton >.	X		X	X	X
2144	*	44D415502-044	Keybutton ? /	X		X	X	X
2145	*	44D415502-045	Keybutton ~ !	X		X	X	X
2146	*	44D415502-046	Keybutton □	X		X	X	X
2147	*	44D415502-047	Keybutton □	X		X	X	X
2148	*	44D415502-048	Keybutton ^ ~	X		X	X	X
2149	*	44D415502-049	Keybutton RPT	X		X	X	X
2150	*	44D415502-050	Keybutton BS	X		X	X	X
2151	*	44D415502-051	Keybutton HT	X		X	X	X
2152	*	44D415502-052	Keybutton FF	X		X	X	X
2153	*	44D415502-053	Keybutton LF	X		X	X	X
2154	*	44D415502-054	Keybutton ESC	X		X	X	X
2155	*	44D415502-055	Keybutton LOK	X		X	X	X
2156	*	44D415502-056	Keybutton CTL	X		X	X	X
2157	*	44D415502-057	Keybutton RETURN	X		X	X	X
2158	*	44D415502-058	Keybutton SHIFT	X		X	X	X
2159	*	44D415502-059	Keybutton DEL	X		X	X	X
2160	*	44D415502-060	Keybutton VT	X		X	X	X
2164	*	44D415502-064	Keybutton ◇ (Square O)	X		X	X	X

*Shown in Figure 23 without reference number.

CODE	FIGURE	PART NO.	DESCRIPTION	KSR	RO	A	B	C
2001	23-2	44C414042-001	Keyboard Assembly	X		X	X	
2006	25-3	44C414159-001	Keyboard Assembly	X				X
2216	22-14	44A410219-001	Keyboard Assembly	X		X	X	
2306	24-5	44A410017-001	Keyboard Assembly	X				X
2205	22-15	44A410037-001	Keyboard Assembly	X		X	X	X
2302	26-1	44B410441-001	Keyboard Assembly (SLC)	X				X
2300	22-16	44B410441-001	Keyboard Assembly (SLC)	X		X	X	
2213	27-7	44B410441-001	Keyboard Assembly	X		X	X	
2223			Keyboard Assembly	X				X
2100	23-3		Keyboard Assembly	X		X	X	
2099	25-4		Keyboard Assembly	X				X
2221	22-17		Keyboard Assembly (S)	X		X	X	X
2224			Keyboard Assembly (S)	X		X	X	X
2303	25-5		Keyboard Assembly	X				X

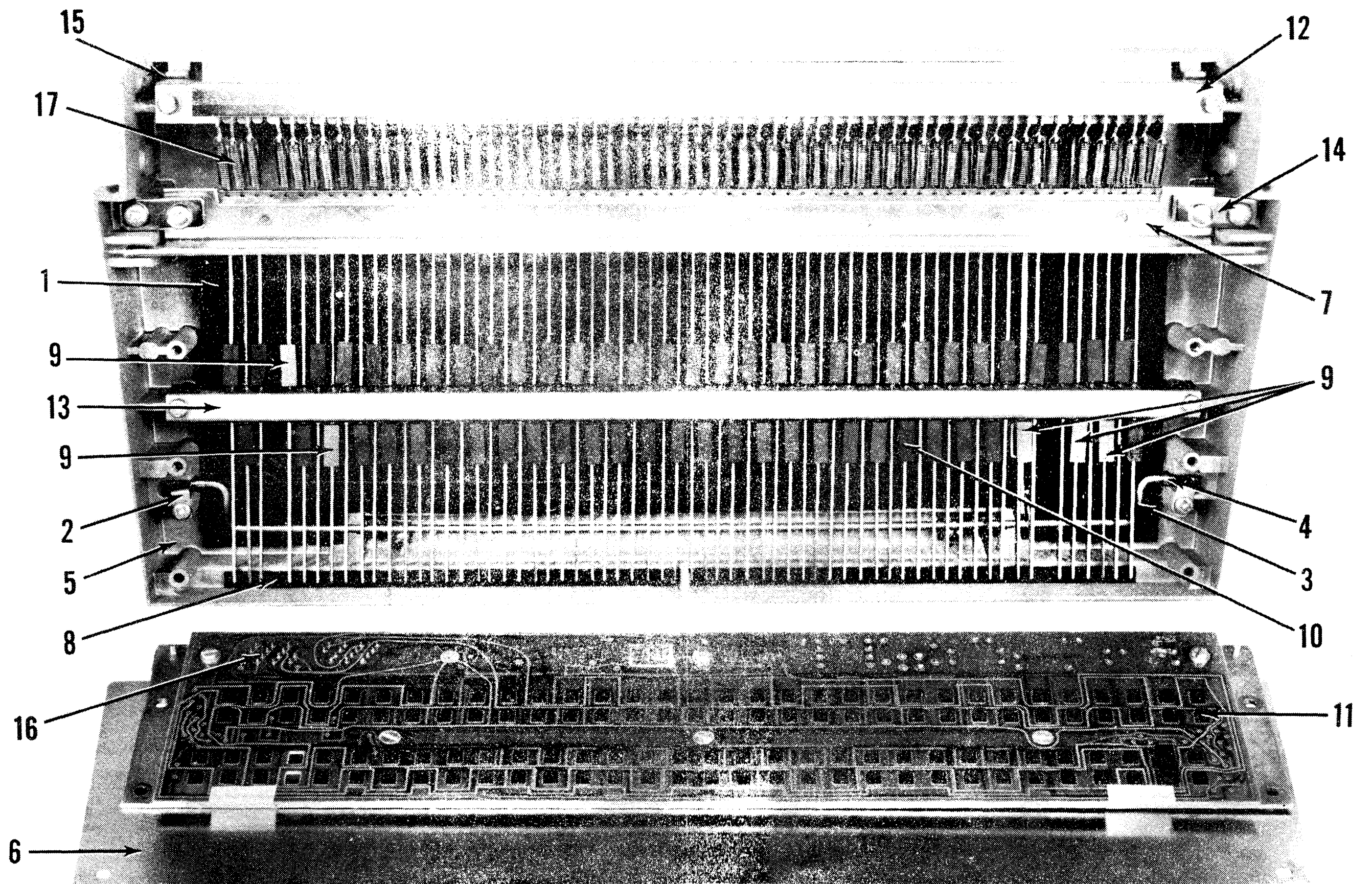

Keyboard Assembly - Models A and B

Figure 22

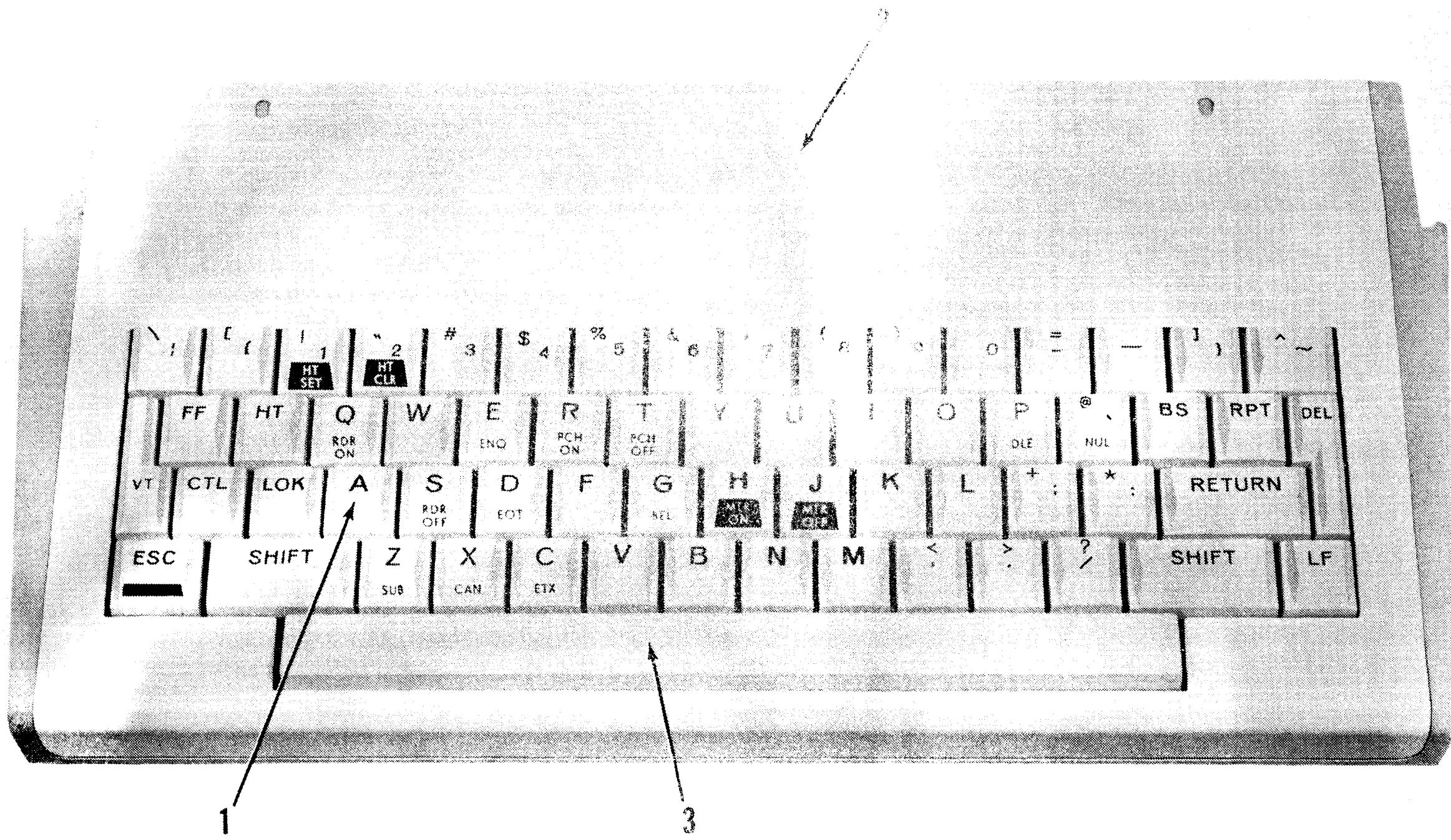

Keyboard Assembly - Models A and B
Figure 23

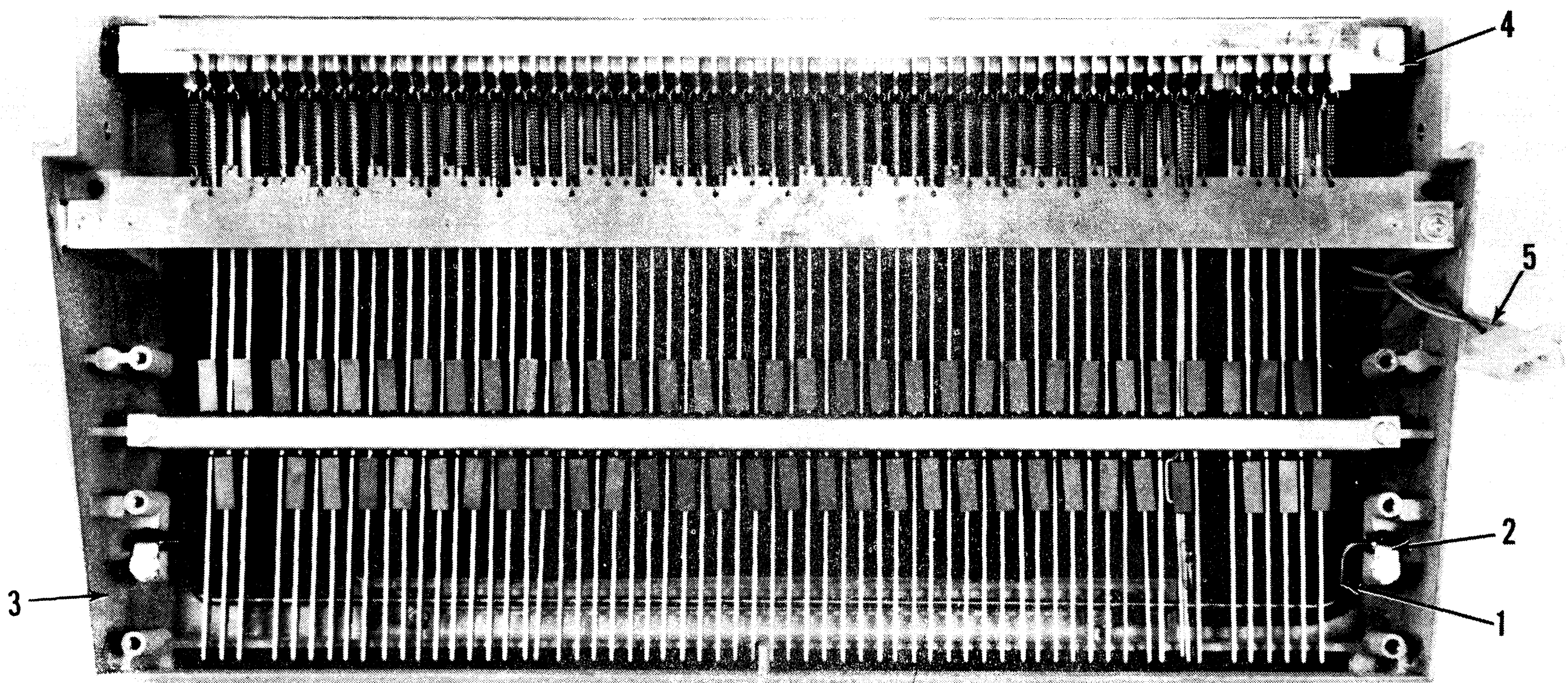

Keyboard Assembly - Model C
(Less SLC Assembly)
Figure 24

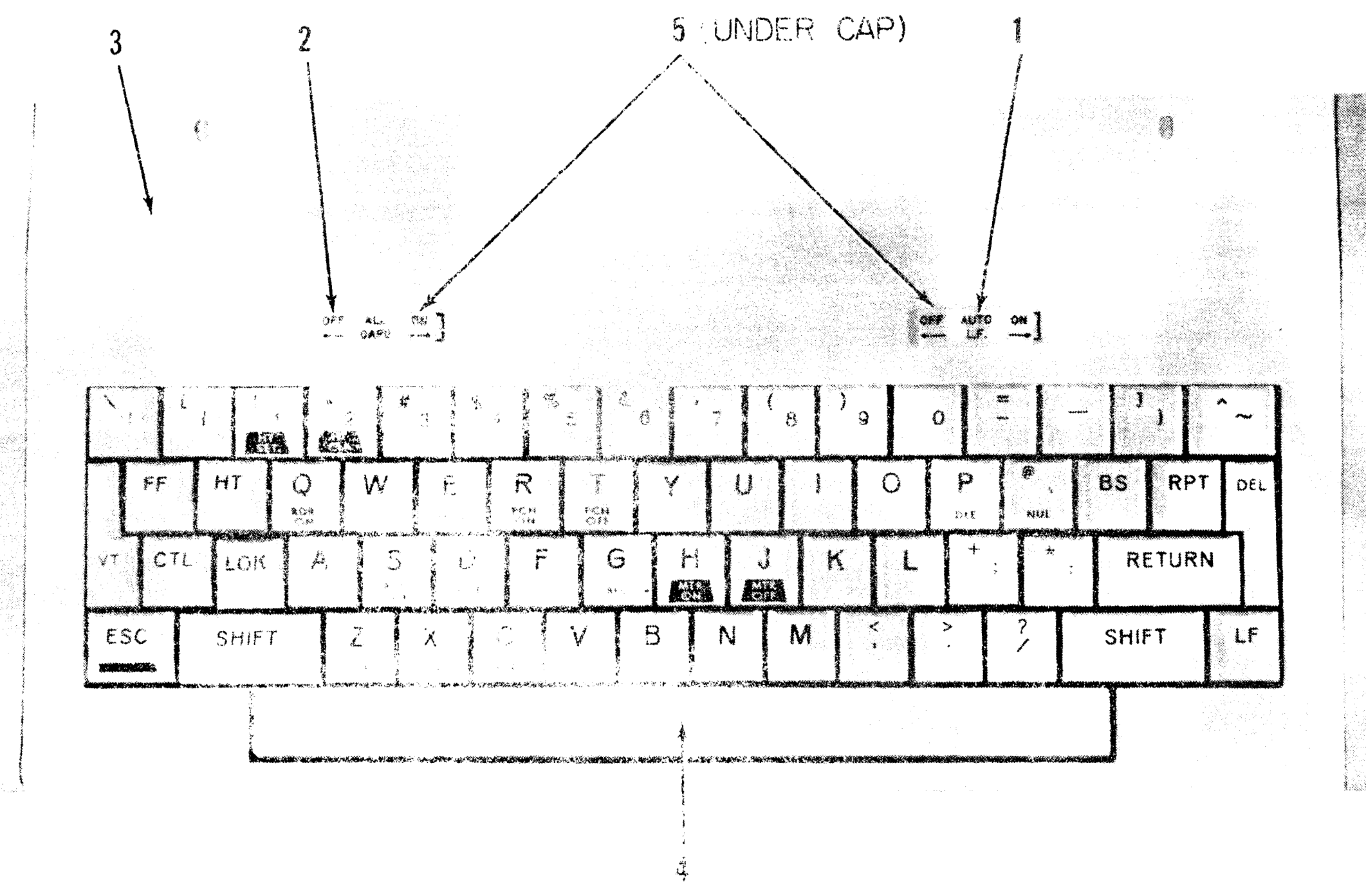

Keyboard Assembly - Model C
Figure 25

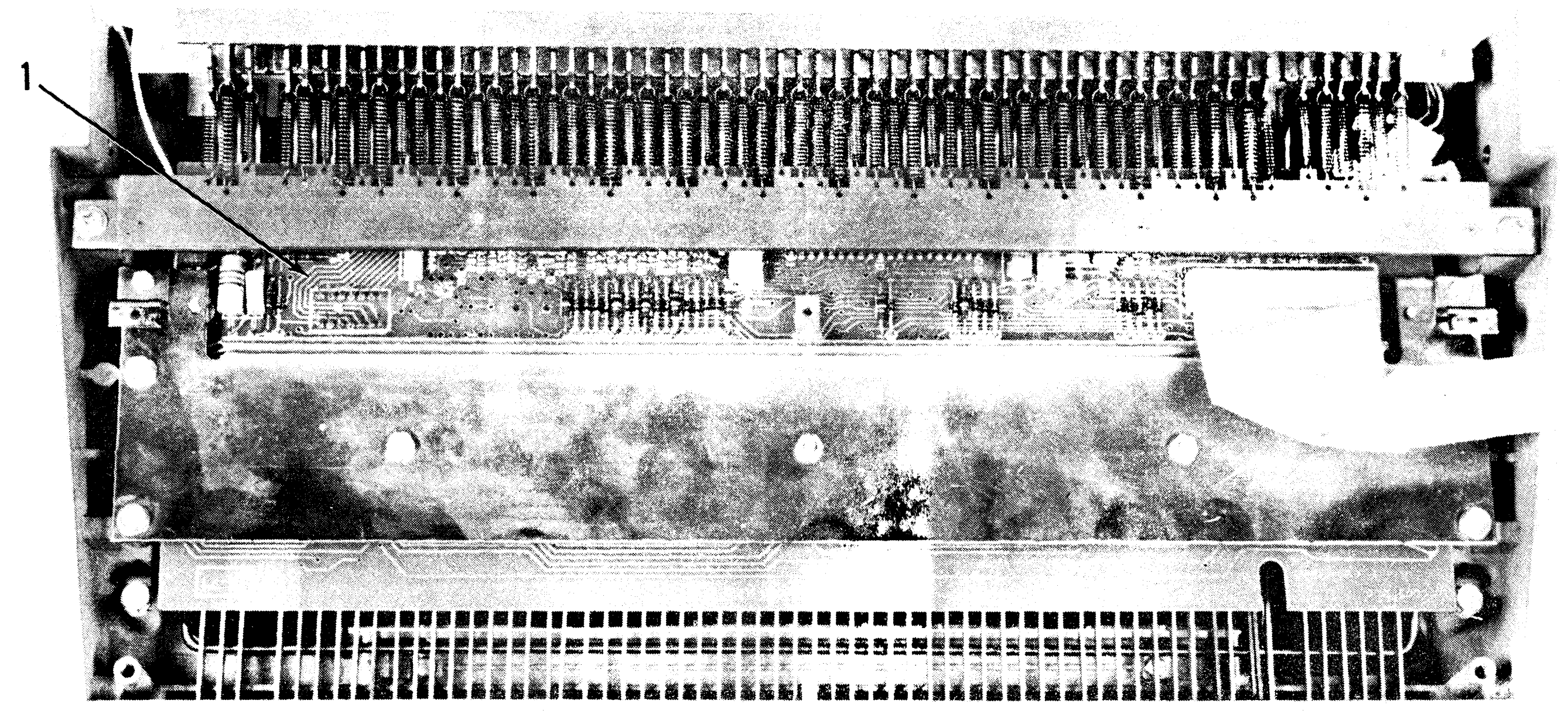

Keyboard Assembly - Model C
Figure 26

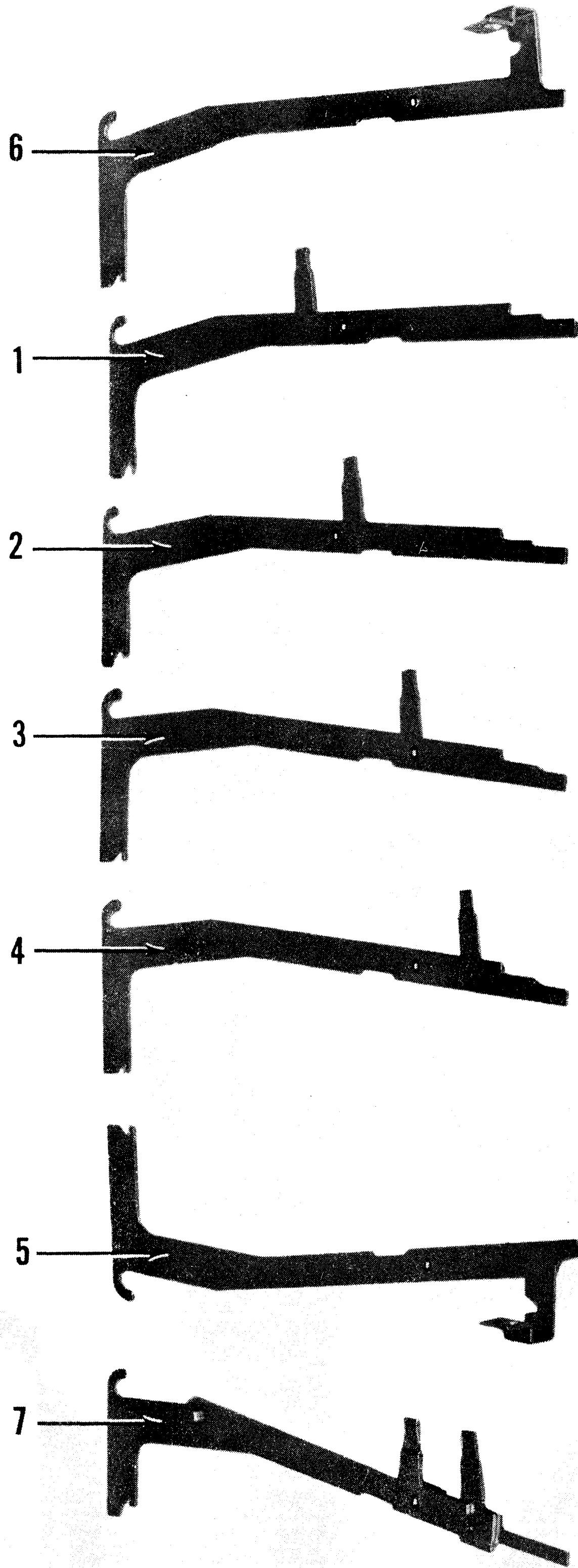

Keybars
Figure 27

SECTION 3 CONTROL PANEL ASSEMBLY

<u>CODE</u>	<u>FIGURE</u>	<u>PART NO.</u>	<u>DESCRIPTION</u>	<u>KSR</u>	<u>RO</u>	<u>A</u>	<u>B</u>	<u>C</u>
3131		44B412180-G02	Cable, DAT	X	X	X	X	
3130		44B412180-G01	Cable, PPI	X		X	X	
3000	28-	44C414148-	Control Panel Asm.	X		X	X	
3020		44C414149-	Control Panel Asm.		X		X	
3011	29-	44C414164-	Control Panel Asm.					X
3100	30-1	44C414081-G01	Control Panel Support Asm. (1)	X		X	X	
3101		44C414081-G02	Control Panel Support Asm. (2)	X		X	X	
3104		44C414081-G05	Control Panel Support Asm. (3)	X		X	X	
3105		44C414081-G06	Control Panel Support Asm. (4)	X		X	X	
3204		44C414074-G02	Control Panel Support Asm. (5)		X	X	X	
3208		44C414074-G03	Control Panel Support Asm. (6)		X	X	X	
3195		44C414074-G04	Control Panel Support Asm. (7)		X		X	
3137		44C414037-G07	Faceplate, 200 Baud	X		X	X	
3110	31-1	44C414037-G01	Faceplate, 300 Baud	X		X	X	
3134		44C414037-G04	Faceplate, 300 Baud		X	X	X	
3135		44C414037-G05	Faceplate, 600 Baud	X		X	X	
3136		44C414037-G06	Faceplate, 1200 Baud	X		X	X	
3111		44C414037-G02	Faceplate, 1200 Baud	X		X	X	
3188		44C414037-G08	Faceplate, 1200 Baud		X		X	
3016	32-1	44B417411-G01	JCT PC Board Asm.	X	X			X
3009		327	Lamp (Under 3003 Cover)	X	X	X	X	
3018		7327	Lamp (Under 3010 Cover)	X	X			X
3112	31-2	44C414044-001	Nameplate (8)	X		X	X	
3113		44C414044-002	Nameplate (9)	X		X	X	
3114		44C414044-004	Nameplate (10)	X		X	X	
3115		44C414044-005	Nameplate (11)	X		X	X	
3116		44C414044-007	Nameplate (12)	X		X	X	
3117		44C414044-008	Nameplate (13)	X		X	X	
3118		44C414044-010	Nameplate (14)	X		X	X	
3119		44C414044-011	Nameplate (15)	X		X	X	
3122		44C414044-019	Nameplate, with Form Feed		X	X	X	
3124		44C414157-001	Nameplate, Short Line	X				X
3125		44C414157-002	Nameplate, No PPI		X			X
3126	33-1	44A410589-001	Nameplate, Long Line	X				X

- (1) For 300 Baud, with Transparency and Here Is
- (2) For 300 Baud, with Here Is, No Transparency
- (3) For 1200 Baud, with Transparency and Here Is
- (4) For 1200 Baud, with Here Is, No Transparency
- (5) For 300 Baud, No Form Feed
- (6) For 300 Baud, with Form Feed
- (7) For 1200 Baud, with Form Feed
- (8) For Long Line, with Transparency and Here Is
- (9) For Long Line, with Here Is, No Transparency
- (10) For Short Line, with Transparency and Here Is
- (11) For Short Line, with Here Is, No Transparency
- (12) For Long Line, with Transparency, No Here Is
- (13) For Long Line, No Transparency or Here Is
- (14) For Short Line, No Transparency or Here Is
- (15) For Short Line, No Transparency or Here Is

<u>CODE</u>	<u>FIGURE</u>	<u>PART NO.</u>	<u>DESCRIPTION</u>	<u>KSR</u>	<u>RO</u>	<u>A</u>	<u>B</u>	<u>C</u>
3012		44A410325-G01	PPI Asm. (2 Pos.)	X		X	X	
3013	34-1	44A410325-G02	PPI Asm. (3 Pos.)	X		X	X	
3014		44B417412-G01	PPI Asm. (2 Pos.)	X				X
3015	32-2	44B417412-G02	PPI Asm. (3 Pos.)	X				X
3005	31-3	44A417054-001	Readout Lamp, PPI	X		X	X	
3004		44A417042-001	Socket, Readout Lamp	X		X	X	
3008	34-2	44A417056-001	Speaker	X	X	X	X	
3017	32-3	44A417056-002	Speaker	X	X			X
3003	34-3	44A417058-501	Switch, Pushbutton	X	X	X	X	
3010	32-4	44A417700-001	Switch, Pushbutton	X	X			X
3001	34-4	44A417038-001	Switch, Toggle (2 Pos.)	X	X	X	X	X
3002	34-5	44A417039-001	Switch, Toggle (3 Pos.)	X	X	X	X	X
3007	34-6	44A417044-002	Terminal Posts and Insulator	X	X	X	X	

44C414148-

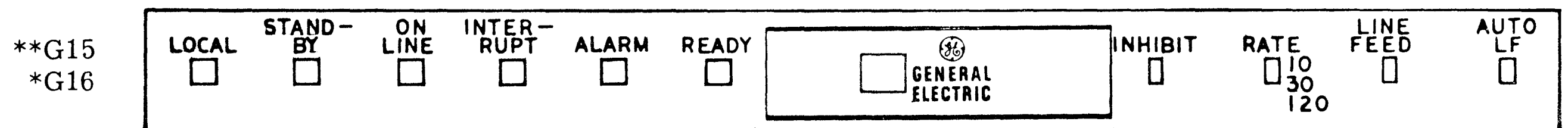
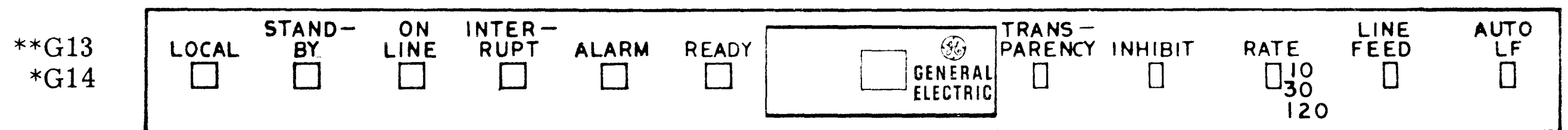
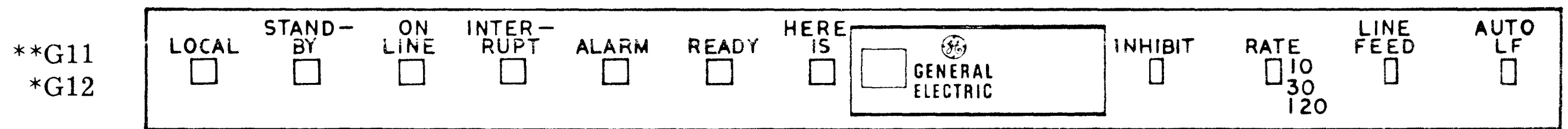
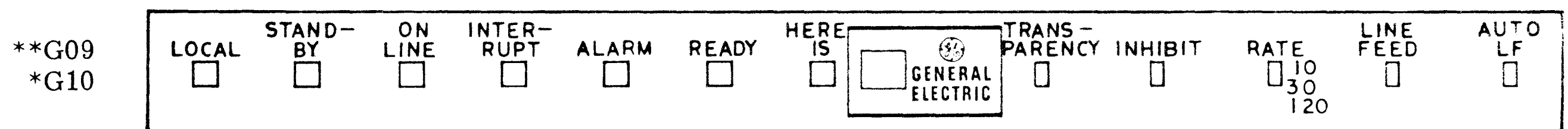
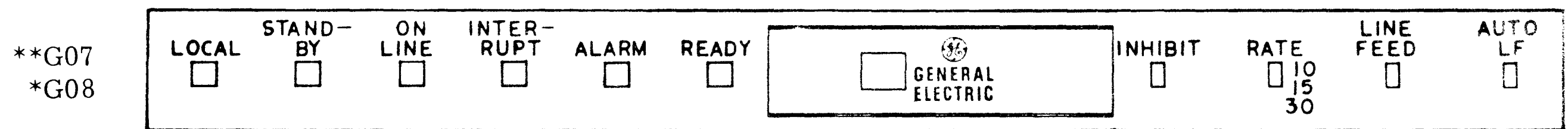
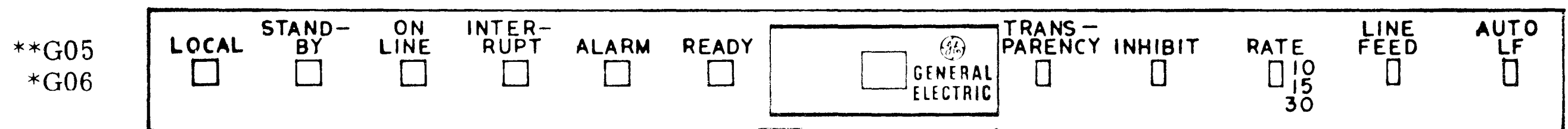
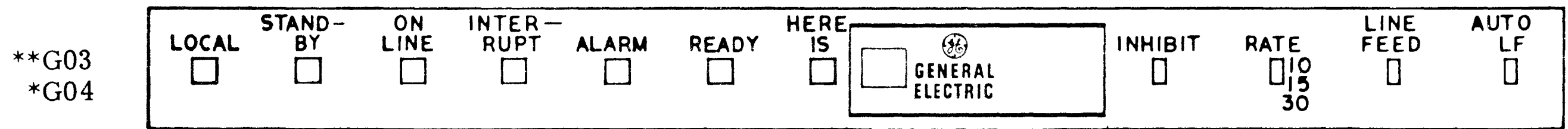
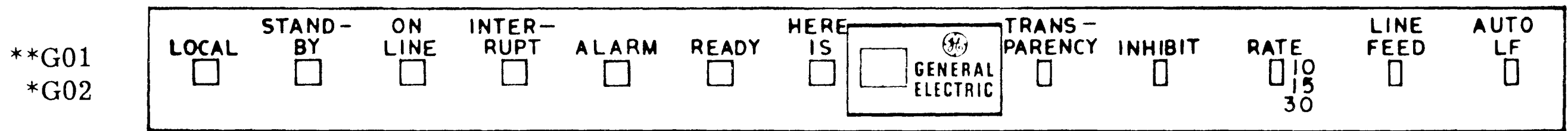

*Short Print Line --- G02, G04, G06, G08, G10, G12, G14, G16
 **Long Print Line --- G01, G03, G05, G07, G09, G11, G13, G15

Control Panel Assemblies
 (Models A & B - KSR)

Figure 28

44C414164-

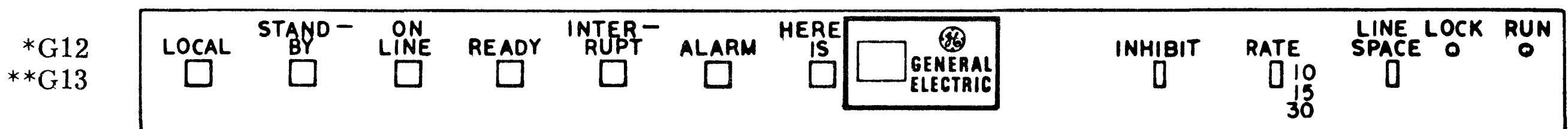
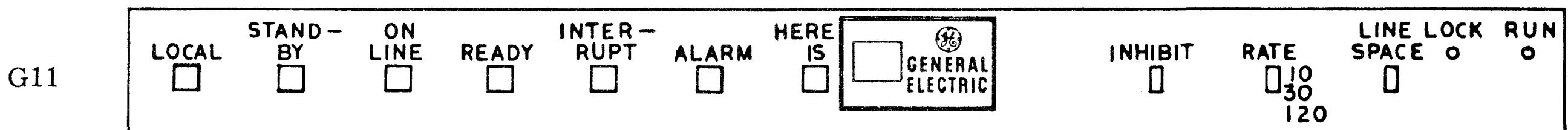
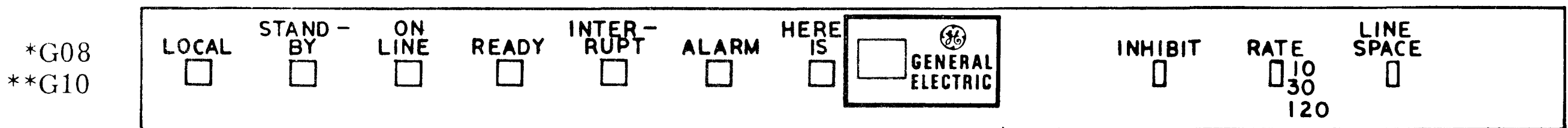
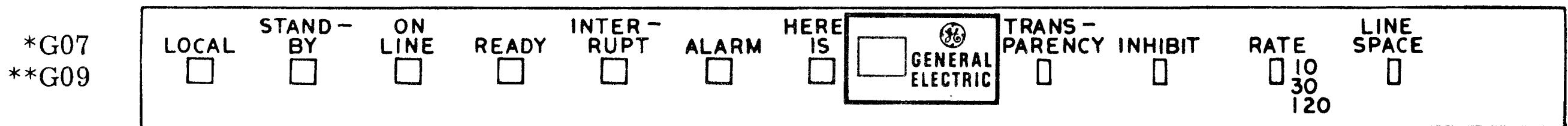
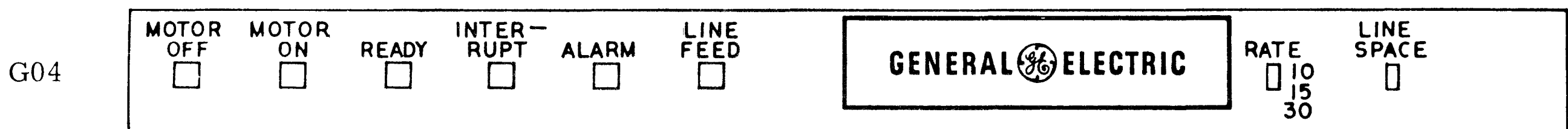
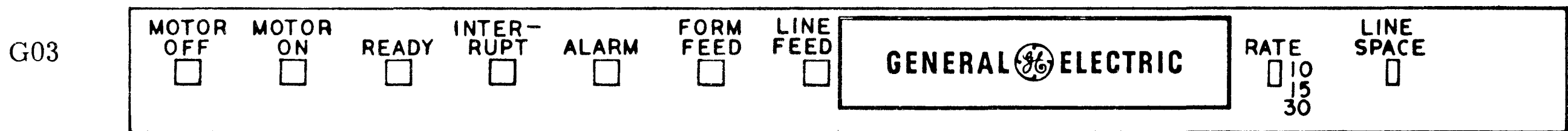
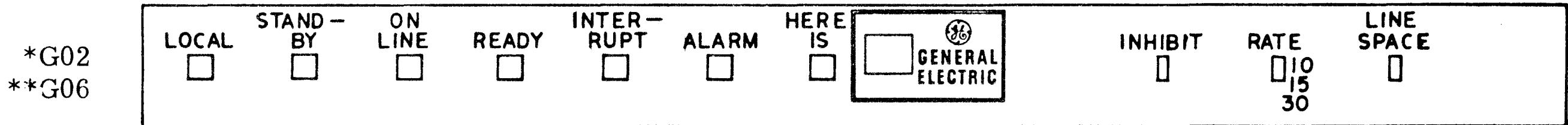
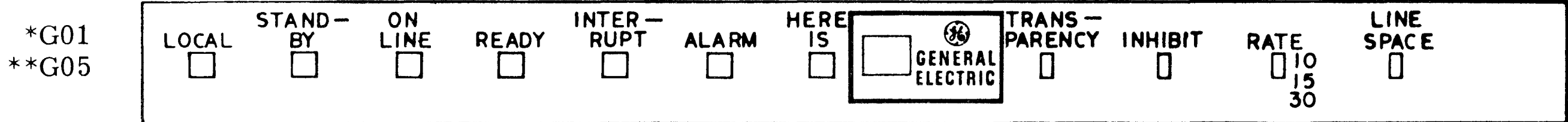

*Short Print Line ---G01, G02, G07, G08, G12

**Long Print Line ---G05, G06, G09, G10, G11, G13

Control Panel Assemblies
(Model C - KSR & R0)

Figure 29

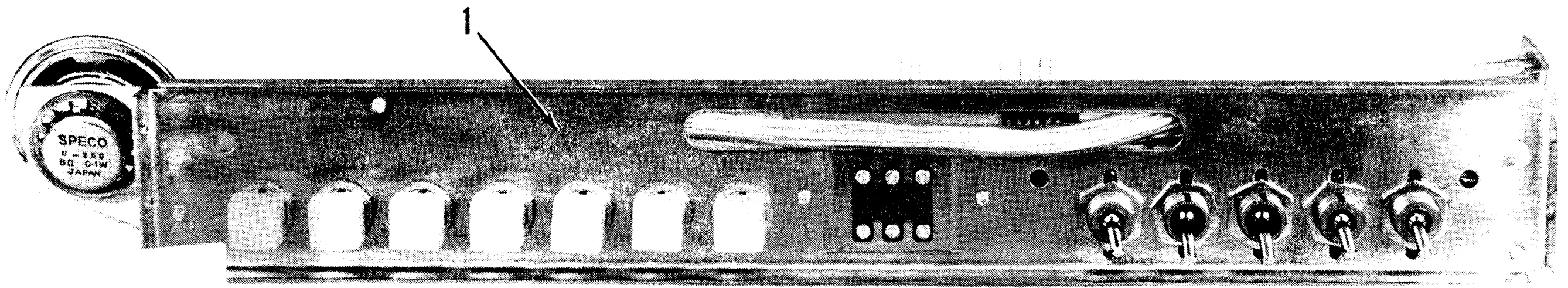

Control Panel Support Assembly

Figure 30

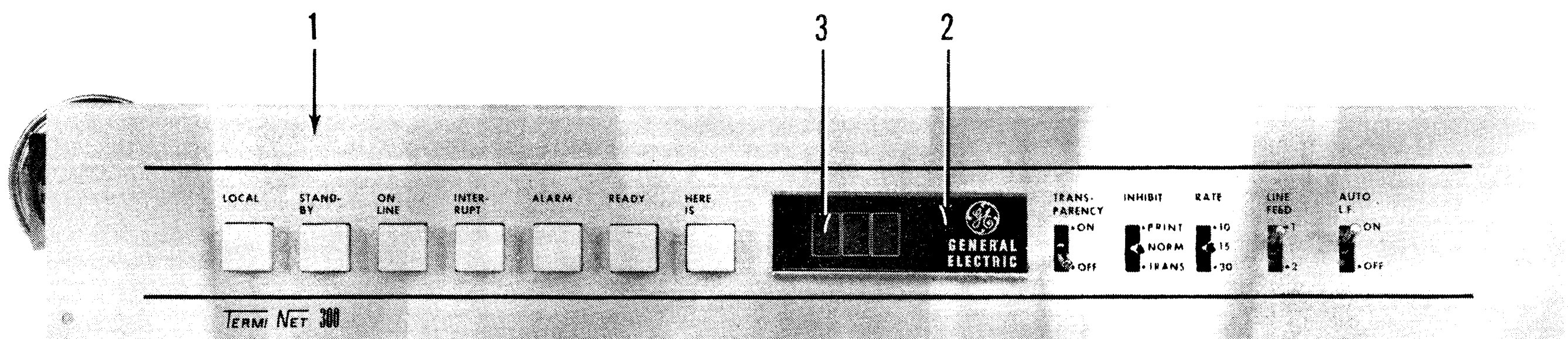

Control Panel Assembly

Figure 31

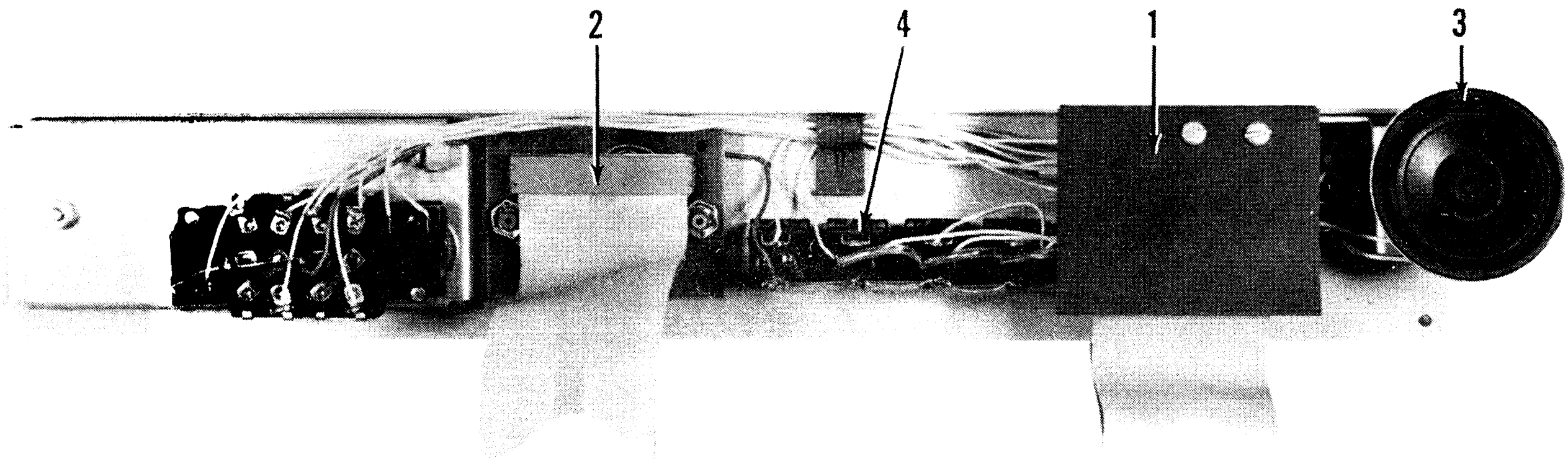

Control Panel Assembly
(Model C)
Figure 32

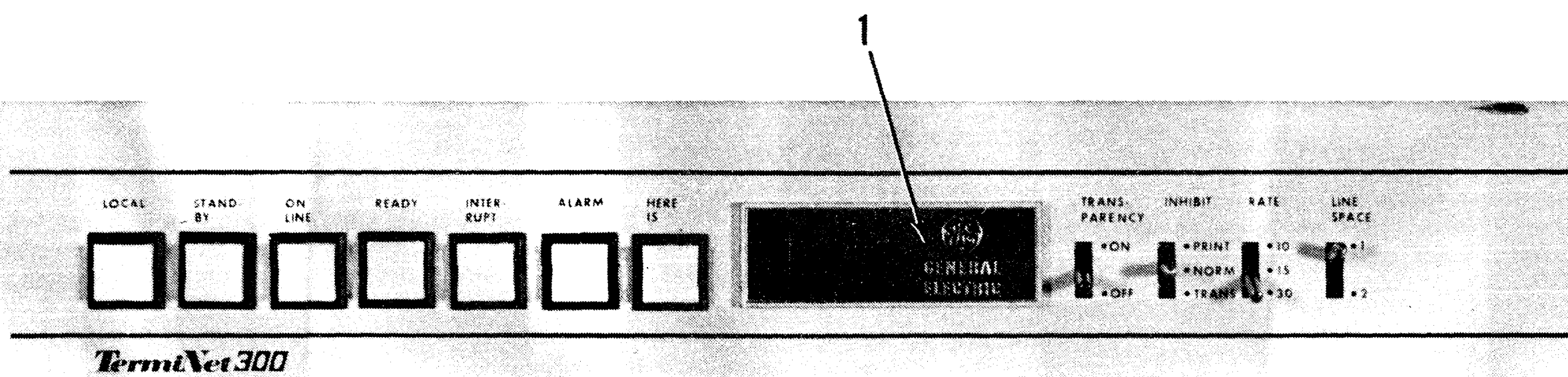

Control Panel Assembly
(Model C)
Figure 33

CODE	FIGURE	PART NO.	DESCRIPTION	KSR	RO	A	B	C
4503		44A410402-093	Finger } Finger } Finger } Finger } Finger }	X	X	X	X	X
4504		44A410402-094		X	X	X	X	X
4506		44A410402-099		X	X	X	X	X
4507		44A410402-097		X	X	X	X	X
4508		44A410402-098		X	X	X	X	X
4410		44B412205-G02	Fonts, Standard (2)	X	X	X	X	X
4607	41-2	44C414002-001	Guide, Front Belt	X	X	X	X	X
4608	41-3	44C414003-001	Guide, Rear Belt	X	X	X	X	X
4013	35-1	44C414004-001	Hammer #1	X	X	X	X	X
4014	35-2	44C414005-001	Hammer #2	X	X	X	X	X
4015	35-3	44C414004-001	Hammer #3	X	X	X	X	X
4016	35-4	44C414005-001	Hammer #4	X	X	X	X	X
4000		44E416500-G01	Hammer and Belt Assembly (75)	X	X	X	X	X
4001	41-1	44E416500-G02	Hammer and Belt Assembly (118)	X	X	X	X	X
4003		44E416500-G03	Hammer and Belt Assembly (80)	X	X	X	X	X
4110		44A410206-001	Lamp, Fluorescent (75 and 80)	X	X	X	X	X
4117	44-2	44A410206-002	Lamp, Fluorescent (118)	X	X	X	X	X
4122		44A410212-G02	Lamp Holder (75 and 80), Rt.	X	X	X	X	X
4123	44-3	44A410212-G03	Lamp Holder (118), Rt.	X	X	X	X	X
4113	44-4	44A410212-G01	Lamp Holder, Lf.	X	X	X	X	X
4107	42-3	44A410019-002	Nut, Belt Pivot	X	X	X	X	X
4115	40-3	44A417005-001	Nut, Self Locking	X	X	X	X	X
4627		44B412477-G01	Paper Holder (75)	X	X	X	X	X
4628	38-2	44B412477-G02	Paper Holder (118)	X	X	X	X	X
4629		44B412477-G03	Paper Holder (80)	X	X	X	X	X
4630		44B412477-G04	Paper Holder (50)	X	X	X	X	X
4619		44C414152-001	Paper Shield (1)	X	X	X	X	X
4614		44D415593-001	Paper Shield (2)	X	X	X	X	X
4015		44D415517-001	Paper Shield (3)	X	X	X	X	X
4016		44D415516-001	Paper Shield (4)	X	X	X	X	X
4617		44D415514-001	Paper Shield (5)	X	X	X	X	X
4618		44D415545-G01	Paper Shield (6)	X	X	X	X	X
4020	40-4	44D415501-G01	Photocell Assembly	X	X	X	X	X
4105	36-1	44A410012-001	Pin, Shield Pivot	X	X	X	X	X
4110	40-5	44A410112-001	Plate, Photocell Guide	X	X	X	X	X
4400	41-5	44B412205-G01	Print Belt and Type (Std.)	X	X	X	X	X
4404		44B412205-G06	Print Belt (7)	X	X	X	X	X
4011	40-6	44B412011-001	Pulley, Left	X	X	X	X	X
4012	42-4	44B412012-001	Pulley, Right	X	X	X	X	X
4121	40-7	44B412182-G01	Rebound Bar Assembly	X	X	X	X	X

- (1) For Pin Feed Platens, 75 and 118 column
- (2) For Pin Feed Platen with 8 1/2" Pin-to-Pin Distance
- (3) For Pin Feed Platen with 8" Pin-to-Pin Distance
- (4) For Pin Feed Platen with 9" Pin-to-Pin Distance
- (5) For Pin Feed Platen with 12.344" Pin-to-Pin Distance
- (6) For Friction Feed Platen
- (7) Contains Two Standard Font Tabs, No Type

<u>CODE</u>	<u>FIGURE</u>	<u>PART NO.</u>	<u>DESCRIPTION</u>	<u>KSR</u>	<u>RO</u>	<u>A</u>	<u>B</u>	<u>C</u>
4603		44C414006-001	Reflector (75 and 80)	X	X	X	X	X
4604	44-5	44C414006-002	Reflector (118)	X	X	X	X	X
4021	40-8	44A410000-001	Rod, Hammer Pivot	X	X	X	X	X
4108	42-5	44A410021-002	Screw, Pulley (Rt.)	X	X	X	X	X
4022	40-9	44B412299-G01	Shaft and Gear, Lf. Pulley	X	X	X	X	X
4124		44A410146-001	Shim, Bearing .003"	X	X	X	X	X
4125		44A410146-002	Shim, Bearing .005"	X	X	X	X	X
4126		44A410146-003	Shim, Bearing .007"	X	X	X	X	X
4127		44A410146-004	Shim, Bearing .010"	X	X	X	X	X
4104		44A410009-001	Spring, Belt Tension	X	X	X	X	X
4103	38-1	44A410005-001	Spring, Hammer Return	X	X	X	X	X
4111	43-2	44A410127-001	Spring, Photocell	X	X	X	X	X
4106	40-10	44A410013-001	Spring, Shield	X	X	X	X	X
4118	42-6	44A410227-G01	Switch, Paper Shield	X	X	X	X	X

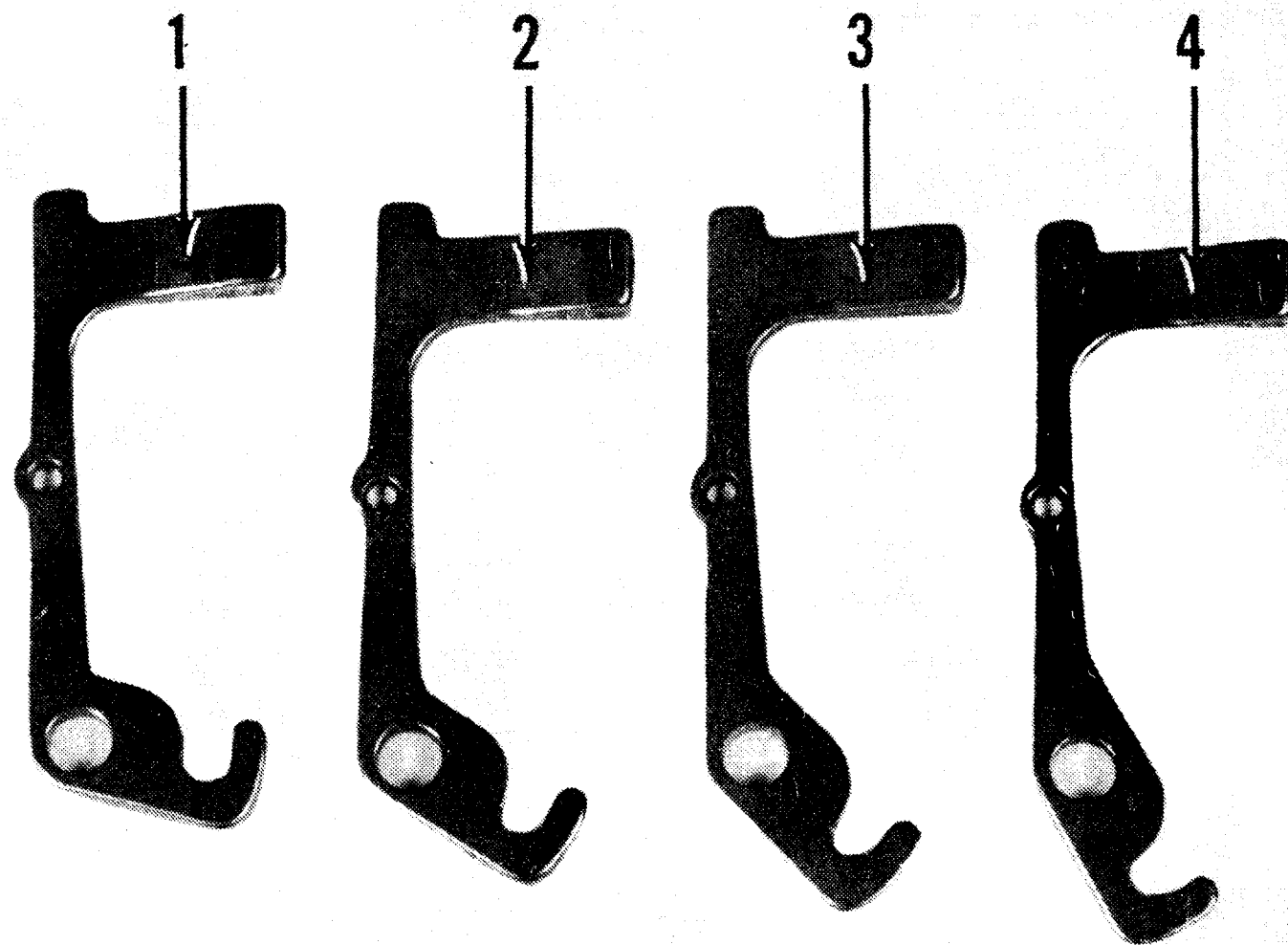

Print Hammers

Figure 35

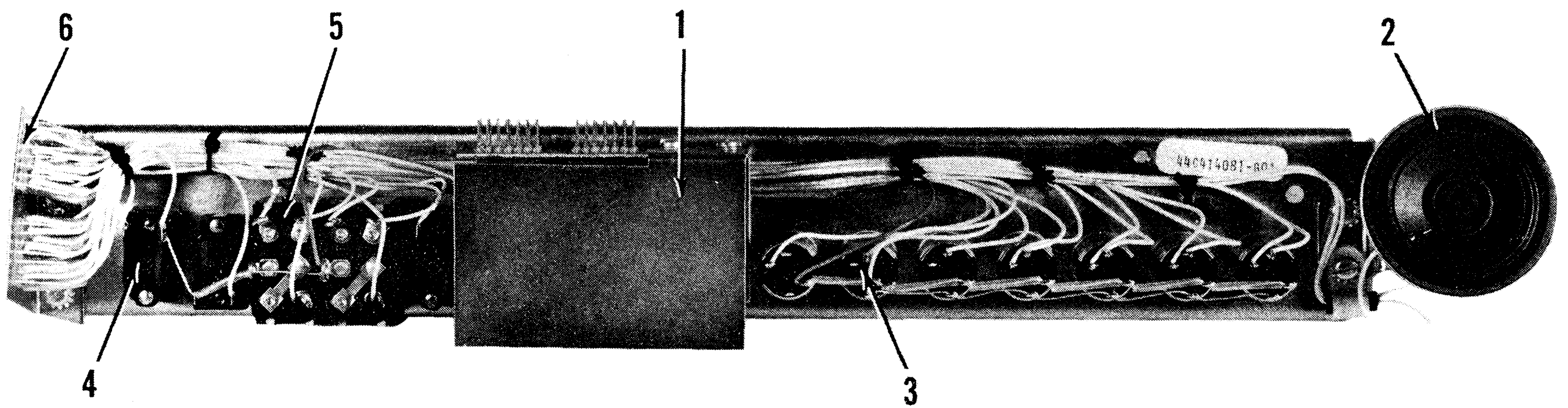

Control Panel Assembly
Figure 34

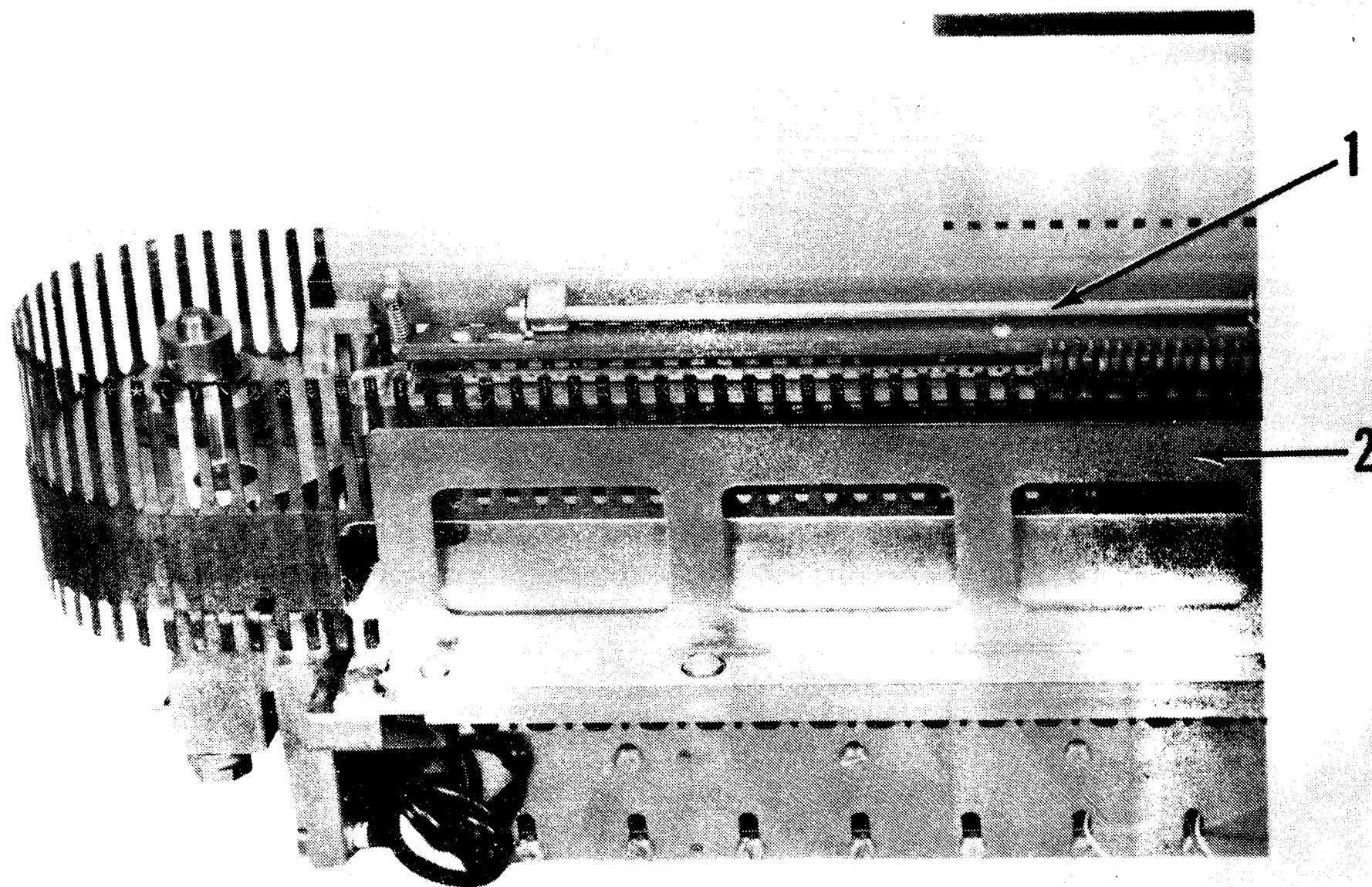

Hammer Bank Assembly
Figure 36

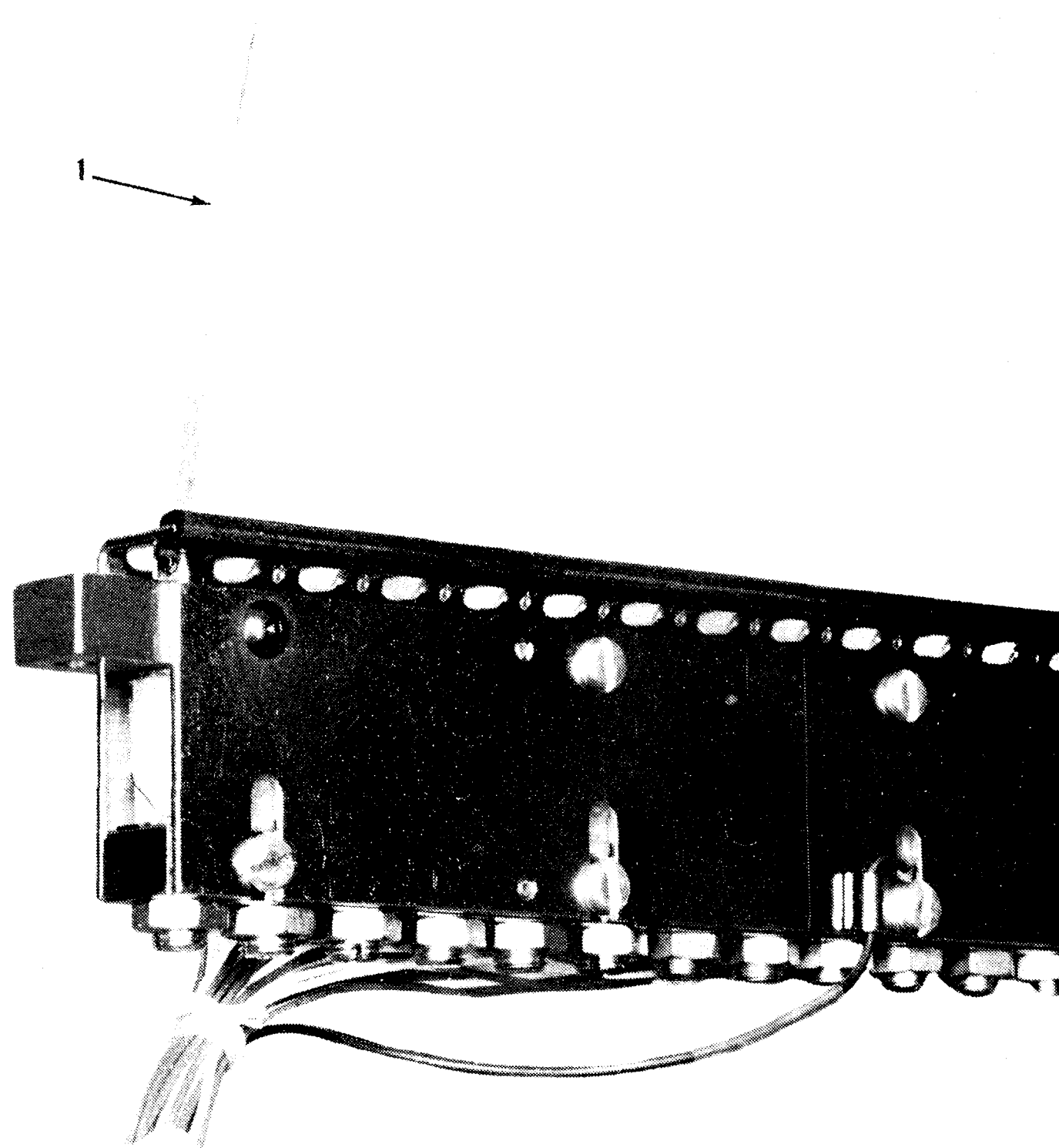

Coil Bank Assembly
Figure 37

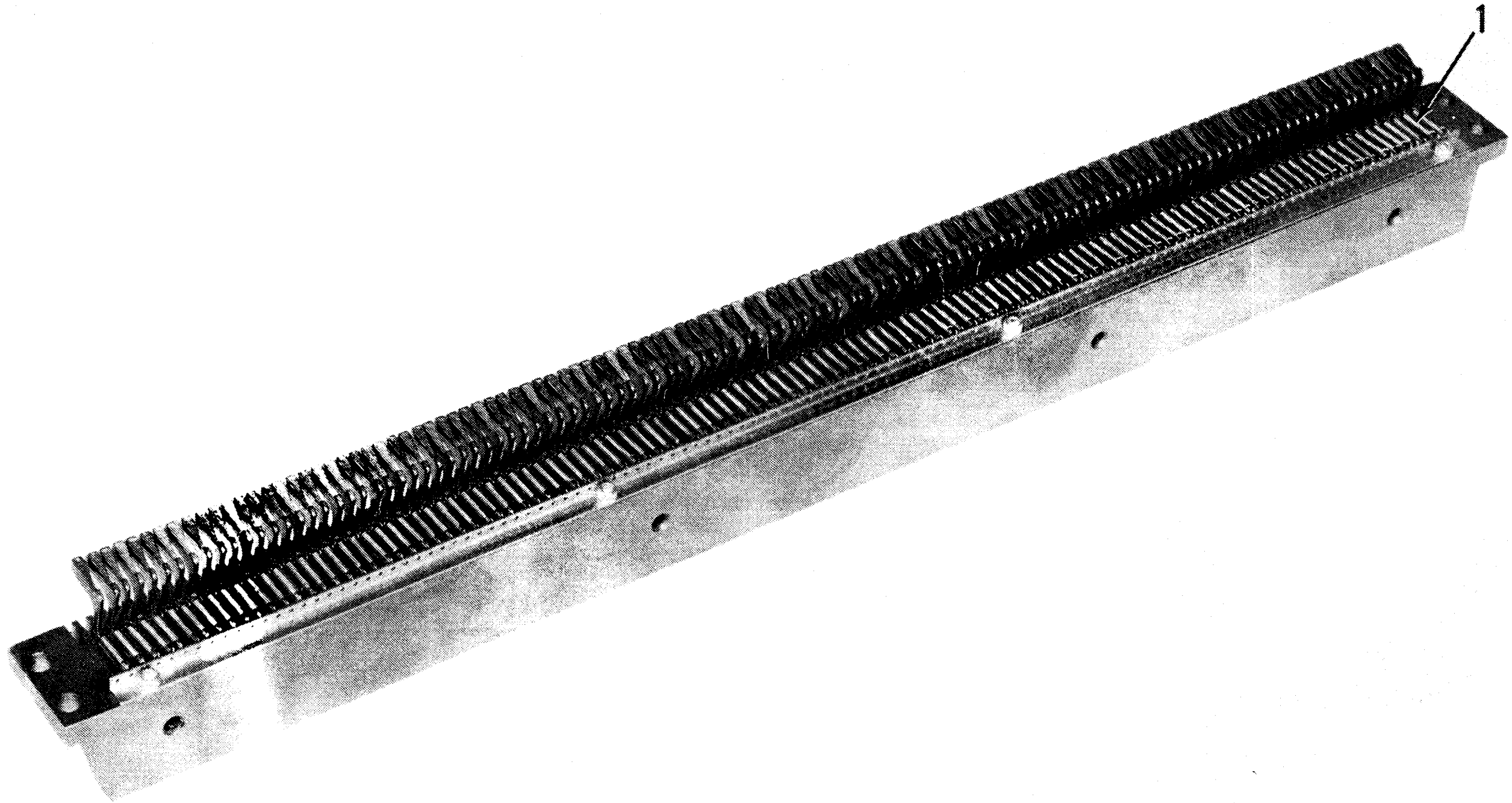

Hammer Bar

Figure 38

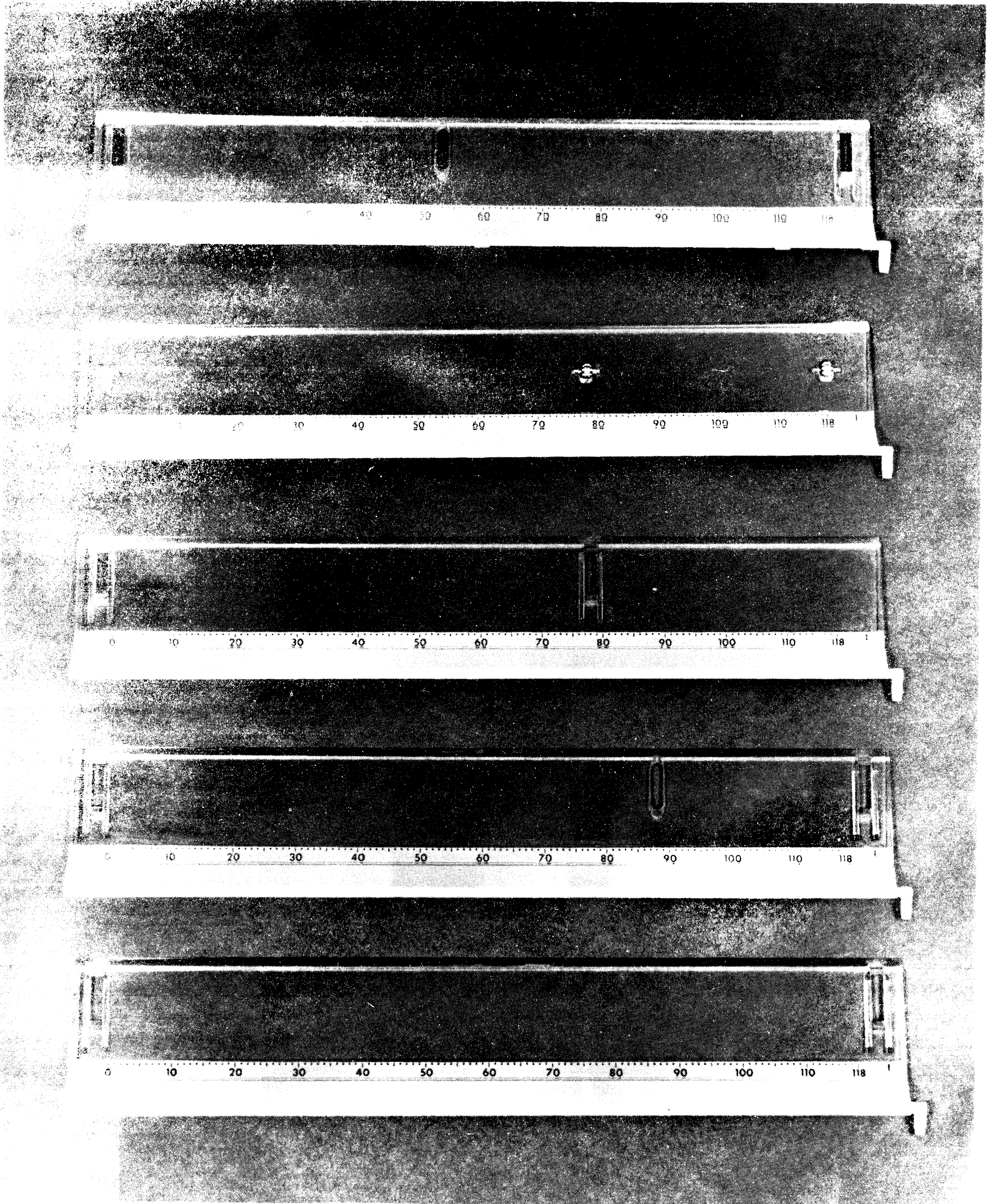

Paper Shields
Figure 39

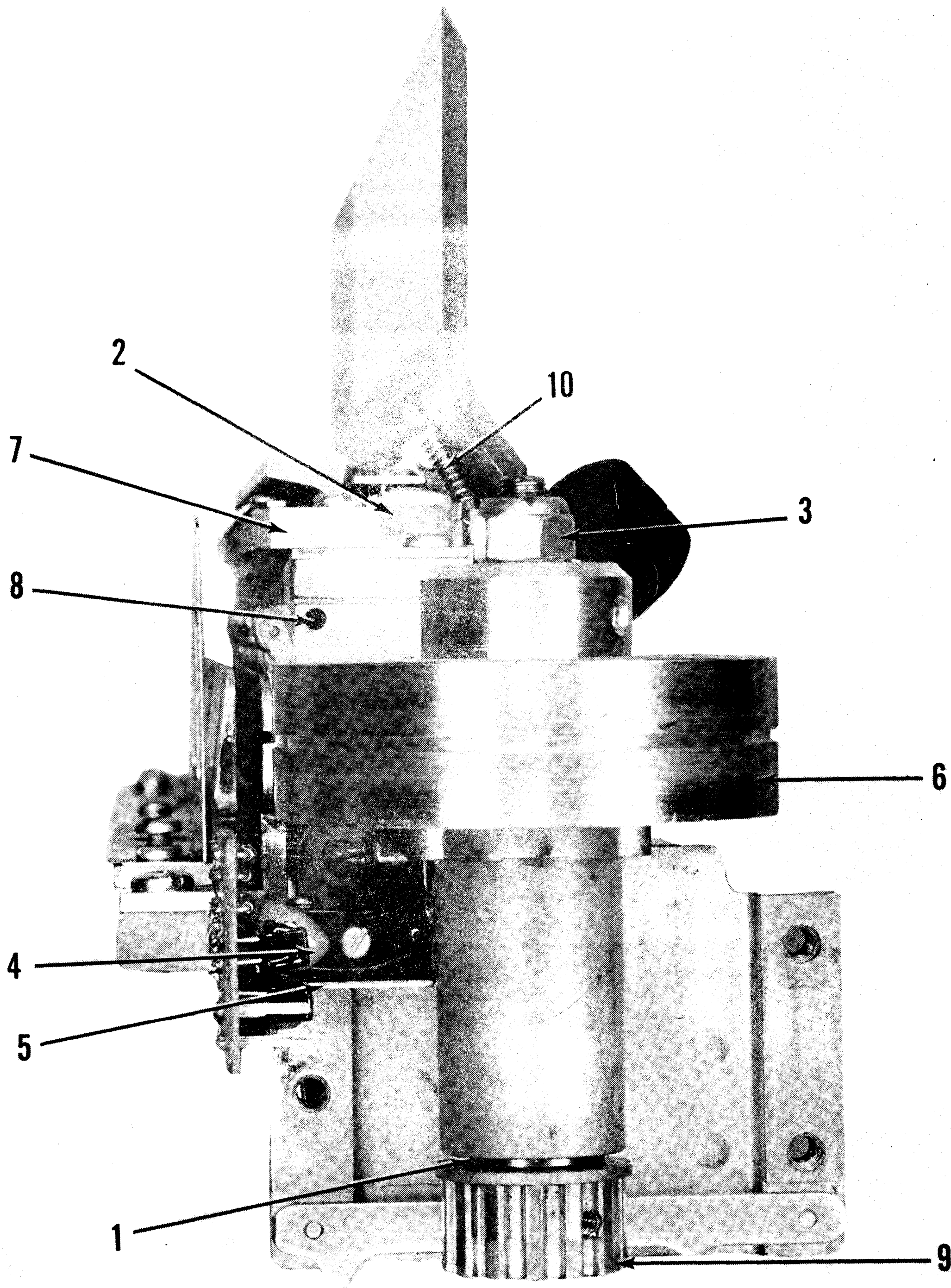

Hammer Bank Assembly
Figure 40

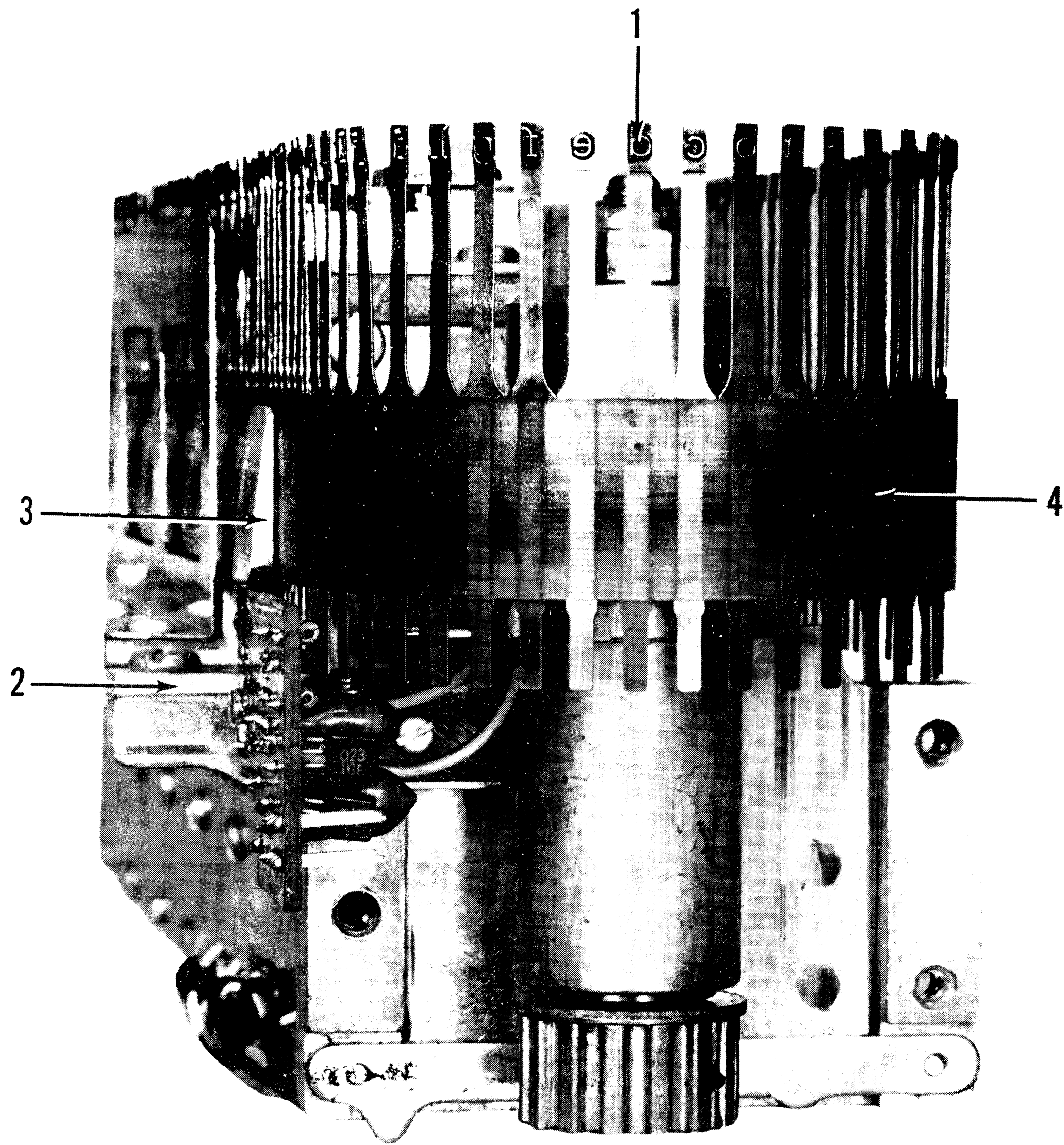

Hammer and Print Belt Assembly

Figure 41

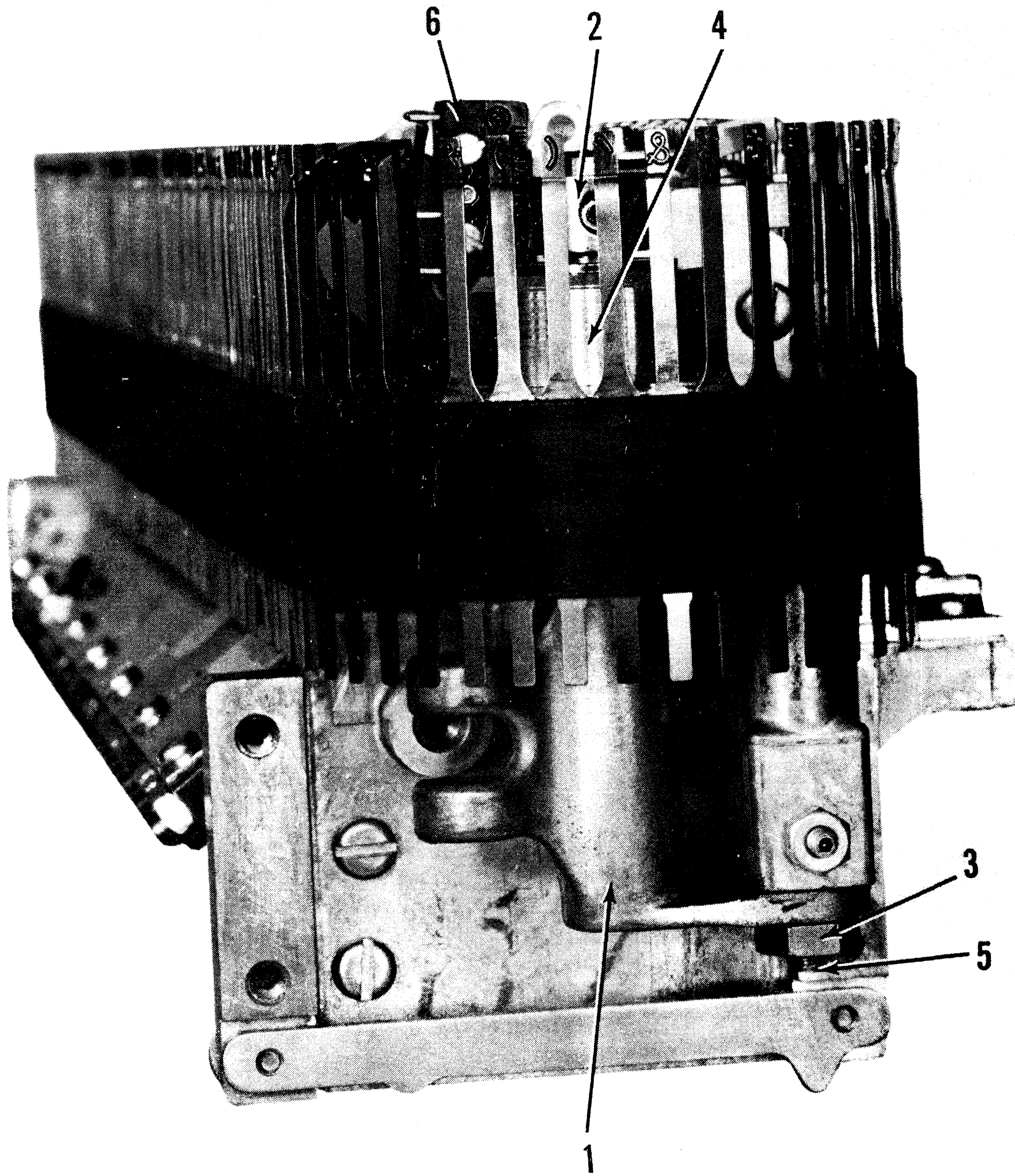

Hammer and Print Belt Assembly

Figure 42

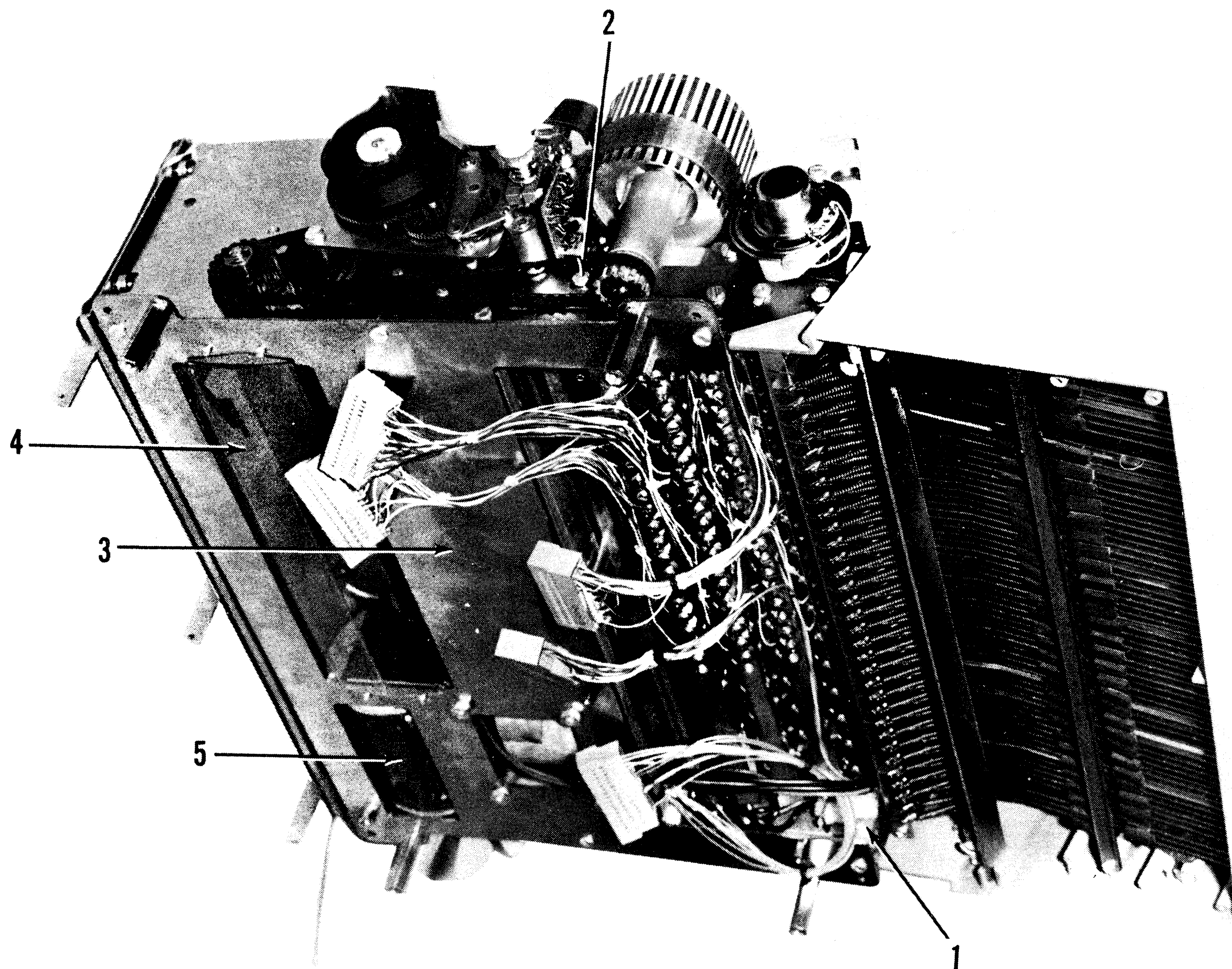

Hammer and Print Belt Assembly

Figure 43

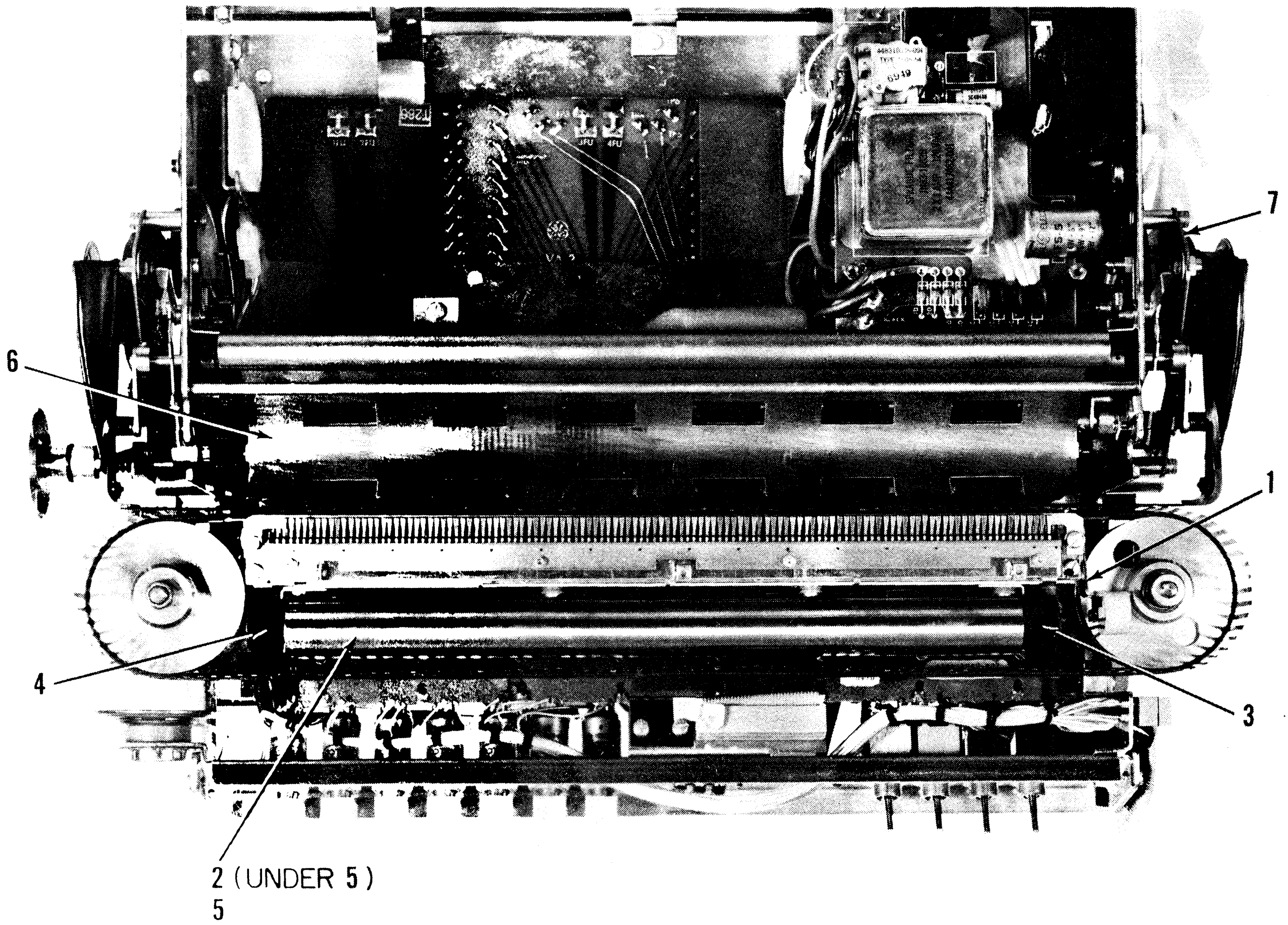

Hammer and Print Belt Assembly

Figure 44

SECTION 5 FRAME ASSEMBLY

<u>CODE</u>	<u>FIGURE</u>	<u>PART NO.</u>	<u>DESCRIPTION</u>	<u>KSR</u>	<u>RO</u>	<u>A</u>	<u>B</u>	<u>C</u>
5201	50-1	44C414035-001	Arm, Ribbon Left	X	X	X	X	X
5301	50-2	44C414034-001	Arm, Ribbon Right	X	X	X	X	X
5043	50-3	44A410241-G01	Arm Asm., Paper Cut	X	X	X	X	X
5078	49-1	44B412149-G01	Arm and Shaft Asm.	X	X	X	X	X
5104	49-2	89G921	Ballast, Fluorescent Lamp	X	X	X	X	X
5032	43-3	44D415501-001	Base Plate	X	X	X	X	X
5033	47-1	44A410515-001	Bearing, Jackshaft Lf.	X	X	X	X	X
5046	49-3	44A417008-001	Bearing, Jackshaft Rt.	X	X	X	X	X
5037	46-1	44A410201-001	Bearing, Paper Tube	X	X	X	X	
5507	55-1	44A410747-001	Bracket (Lf.), HDC Bd. Clamp	X	X			X
5506	55-2	44A410630-001	Bracket (Rt.), HDC Bd. Clamp	X	X			X
5093	56-1	44A410483-001	Bracket, Paper Tube (1)	X	X			X
5095		44A410220-G02	Bracket, Paper Tube Lf. (2)	X	X	X		
5017	47-2	44A410114-001	Bushing, Ribbon Lift	X	X	X	X	X
5074	47-3	44B412097-G01	Cam, Pawl Collar	X	X	X	X	X
5064	47-4	44A417052-M21	Capacitor, Regulate	X	X	X	X	X
5051	47-5	44A417069-J30	Capacitor, Start	X	X	X	X	X
5014	47-6	44A410097-001	Clamp, Capacitor	X	X	X	X	X
5474	54-1	44B412249-001	Clamp, HD Board (Front)	X	X	X	X	
5473	54-2	44A410312-001	Clamp, HD Board (Rear)	X	X	X	X	
5505	55-3	44B412482-001	Clamp, HDC Board	X	X			X
5028	48-1	44C414040-G01	Clamp, Platen Lf.	X	X	X	X	X
5029	46-2	44C414041-G01	Clamp, Platen Rt.	X	X	X	X	X
5441		44B417108-001	Clutch, Line Feed	X	X		X	X
5115	46-3	44C414046-G01	Clutch, Line Feed	X	X	X		
5450	47-7	44B412331-G01	Clutch, Platen	X	X	X	X	X
5044	46-4	44A410284-001	Collar, Ribbon Lift Shaft	X	X	X	X	X
5077	43-4	44B412121-001	Cover, Base	X	X	X	X	
5101	56-2	44B412467-001	Cover, Base	X	X			X
5472	50-4	44C414128-001	Cover, Capacitor	X	X	X	X	X
5021	51-1	44B412294-001	Cover, TXP	X	X	X	X	X
5135	57-1	44A410386-001	Cover, VT-FF	X	X	X	X	X
5136		44A410642-G01	Disc Wheel, 8" VT-FF	X	X	X	X	X
5133	57-2	44A410490-G01	Disc Wheel, 11" VT-FF	X	X	X	X	X
5048	48-2	44A417024-001	Drive Belt, Left	X	X	X	X	X
5047	46-5	44A417024-002	Drive Belt, Right	X	X	X	X	X
5131		44A417341-002	Drive Belt, 8" VT-FF	X	X	X	X	X
5130	57-3	44A417341-001	Drive Belt 11" VT-FF	X	X	X	X	X
5050	46-6	44A417067-001	Fan Blade	X	X	X	X	X
5000	46-	44D415523	Frame Assembly	X	X	X	X	
5001	56-	44D415586	Frame Assembly	X	X			X
5031	46-7	44C414055-G01	Frame Assembly, Lf.	X	X	X	X	X
5030	46-8	44C414048-G01	Frame, Rear	X	X	X	X	
5098	56-3	44C414189-G01	Frame, Rear	X	X			X
5052	46-9	44A417073-001	Fuse, 2A	X	X	X	X	X
5054	50-5	44A417087-009	Fuse, 3A (HDA)	X	X	X	X	
5105	46-10	44A212119-002	Fuse Holder	X	X	X	X	X
5035		44A410182-G01	Gear, Idler Asm.	X	X	X	X	X
5138	57-4	44B412304-001	Gear, VT-FF	X	X	X	X	X
5470	52-1	44C414064-G01	Hamer Decoder (HD) 75	X	X	X	X	

(1) Used on B Models manufactured since fiscal week 30, 1971.

(2) Converts to C Model type Holder with one 5092 Paper Tube and one 5093 bracket.

<u>CODE</u>	<u>FIGURE</u>	<u>PART NO.</u>	<u>DESCRIPTION</u>	<u>KSR</u>	<u>RO</u>	<u>A</u>	<u>B</u>	<u>C</u>
5471		44C414064-G03	Hammer Decoder (HD) 118	X	X	X	X	
5472	52-2	44C414063-G01	Hammer Driver Acc. (HDA)	X	X	X	X	
*5486		44C414166-G01	Hammer Dr. Comb. (HDC) 50	X	X	X	X	
*5487		44C414166-G02	Hammer Dr. Comb. (HDC) 75	X	X	X	X	
*5488		44C414166-G03	Hammer Dr. Comb. (HDC) 80	X	X	X	X	
*5489		44C414166-G04	Hammer Dr. Comb. (HDC) 118	X	X	X	X	
5490		44C414166-G05	Hammer Dr. Comb. (HDC) 50	X				X
5491		44C414166-G06	Hammer Dr. Comb. (HDC) 75	X				X
5492		44C414166-G07	Hammer Dr. Comb. (HDC) 80	X				X
5493	55-4	44C414166-G08	Hammer Dr. Comb. (HDC) 118	X				X
5494		44C414166-G09	Hammer Dr. Comb. (HDC) 50		X			X
5495		44C414166-G10	Hammer Dr. Comb. (HDC) 75		X			X
5496		44C414166-G11	Hammer Dr. Comb. (HDC) 80		X			X
5497		44C414166-G12	Hammer Dr. Comb. (HDC) 118		X			X
5039	46-11	44A410220-G01	Holder, Paper Left	X	X	X	X	
5019	49-4	44A410148-002	Holder, Paper Tube (Rt.)	X	X	X	X	
5016	47-8	44A410103-001	Idler, Front	X	X	X	X	X
5137	57-5	44B412305-001	Idler, VT-FF	X	X	X	X	X
**5479	47-9	44B412469-001	Jackshaft	X	X		X	X
5481	54-4	44B412233-G01	Knob, Platen	X	X	X	X	X
5080	49-5	44A410167-001	Knob, Pressure Release	X	X	X	X	X
5036	46-12	44A410194-G01	Lever, Release	X	X	X	X	X
5013	46-13	44A410078-G01	Lever, Reversing	X	X	X	X	X
5018	47-10	44A410119-G01	Lifting Arm, Ribbon	X	X	X	X	X
5202	48-3	44A410092-001	Link, Reversing Mech.	X	X	X	X	X
5045	43-5	44A410302-G01	Motor	X	X	X	X	X
5015	47-11	44A410099-001	Nut, Base	X	X	X	X	X
5024		44B412357-001	Nut, Rear Idler	X	X	X	X	X
5475	54-3	H5601P153	"O" Ring Board Holder	X	X	X	X	
5026	44-6	44C414017-001	Paper Pan, Friction	X	X	X	X	X
5402	53-1	44C414141-001	Paper Pan (3)	X	X	X	X	X
5405		44C414141-002	Paper Pan (4)	X	X	X	X	X
5406		44C414141-003	Paper Pan (5)	X	X	X	X	X
5404		44C414141-007	Paper Pan (6)	X	X	X	X	X
5134	57-6	44B412329-G01	Photocell Asm., VT-FF	X	X	X	X	X
5073	46-13	44B412303-G01	Plate Asm., Solenoid	X	X	X	X	X
5042	47-12	44A410239-001	Plate, Switch	X	X	X	X	X
5460	45-1	44B412124-G02	Platen Asm. (Friction)	X	X	X	X	X
5400	45-2	44B412216-G05	Platen Asm. (7)	X	X	X	X	X
5410	45-3	44B412468-G01	Platen Asm. (8)	X	X	X	X	X
5412		44B412468-G02	Platen Asm. (9)	X	X	X	X	X
5411		44B412457-G01	Platen Asm. (10)	X	X	X	X	X
5413		44B412468-G03	Platen Asm. (11)	X	X	X	X	X

*Requires Conversion Kit 44A410579-G01.

**When replacing Jackshaft in the A Model machine, Line Feed Kit 44A410516-G01 is required.

(3) For 75 column Pin Feed Platen (8" pin to pin distance) or 118 column Pin Feed Platen (12.344" pin to pin distance).

(4) For 80 column Pin Feed Platen (9" pin to pin distance).

(5) For 75 column Pin Feed Platen (8 1/2" pin to pin distance).

(6) For 50 column Pin Feed Platen (5 1/2" pin to pin distance).

(7) For 118 column Pin Feed (12.344" pin to pin distance).

(8) For 75 column Pin Feed (8" pin to pin distance).

(9) For 80 column Pin Feed (9" pin to pin distance).

(10) For 50 column Pin Feed (5 1/2" pin to pin distance).

(11) For 75 column Pin Feed (8 1/2" pin to pin distance).

<u>CODE</u>	<u>FIGURE</u>	<u>PART NO.</u>	<u>DESCRIPTION</u>	<u>KSR</u>	<u>RO</u>	<u>A</u>	<u>B</u>	<u>C</u>
5058	49-6	44B412027-G01	Pressure Roll, Small	X	X	X	X	X
5059	49-7	44B412028-G01	Pressure Roll, Large	X	X	X	X	X
5079	49-8	44B412168-G01	Power Supply (TXP)	X	X	X	X	
5102		44B417406-G01	Power Supply (TXPC)	X	X			X
5069	47-13	44B412430-G01	Pulley, Idler	X	X	X	X	X
5070	46-14	44B412321-001	Pulley, Jackshaft Rt.	X	X	X	X	X
5071	47-14	44B412072-001	Pulley, Jackshaft Lf.	X	X	X	X	X
5072	46-15	44B412073-001	Pulley, Motor	X	X	X	X	X
5448	46-16	44A410166-G02	Relay, Line Feed	X	X	X	X	X
5011	49-9	44A410074-G01	Release, Paper	X	X	X	X	X
5200	48-4	44D415570-G01	Reversing Mech. Lf.	X	X	X	X	X
5300	44-7	44D415571-G01	Reversing Mech. Rt.	X	X	X	X	X
5063	50-6	44B412043-001	Rod, Pan Release Lf.	X	X	X	X	X
5060	49-10	44B412031-001	Rod, Pan Release Rt.	X	X	X	X	X
5057	49-11	44B412025-001	Rod, Pin Feed	X	X	X	X	X
5066	47-15	44B412046-001	Rod Torque	X	X	X	X	X
5020	47-16	44A410150-001	Screw, Alignment	X	X	X	X	
5055	48-5	44A417344-001	Screw, Rear Idler	X	X	X	X	X
5038	46-17	44A410216-001	Screw, Shoulder Lf.	X	X	X	X	X
5061	49-12	44B412041-001	Shaft, Ribbon Reverse	X	X	X	X	X
5195	48-7	44A410146-001	Shim Lf. Reversing Mech.	X	X	X	X	X
5132	57-7	44A410382-001	Shaft, VT-FF	X	X	X	X	X
5027	46-18	44C414019-G01	Side Assembly, Rt.	X	X	X	X	
5097	56-4	44C414167-G01	Side Assembly, Rt. C	X	X			X
5040	47-17	44A410222-G01	Socket, Starter	X	X	X	X	X
5440	47-18	44A410246-G01	Solenoid, Ribbon Lift	X	X	X	X	X
5034	46-19	44A410173-G01	Spring, Backlash	X	X	X		
5010	46-20	44A410072-001	Stop, Tension Limiter	X	X	X	X	X
*5094	56-5	44A410484-001	Stud, Adjusting	X	X			X
5203	48-6	44A410124-001	Stud, Ribbon Arm	X	X	X	X	X
5025	49-13	44C414066-001	Support, Main Frame	X	X	X	X	X
5053	47-19	44A417083-001	Switch, Paper Out	X	X	X	X	X
5076	46-21	44B412119-001	Tension Limiter	X	X	X	X	X
5056	47-20	44B317164-001	Transformer, Power	X	X	X	X	
5099		44B334502-001	Transformer, Power	X	X		X	
5062	50-7	44B412042-001	Tube, Paper Roll	X	X	X	X	
*5092	56-6	44A410482-G01	Tube, Paper Roll	X	X			X
5064	49-14	44B412044-G01	Yoke, Pressure Roll Lf.	X	X	X	X	X
5065	49-15	44B412045-G01	Yoke, Pressure Roll Rt.	X	X	X	X	X
5012	51-2	44A410075-001	Yoke, Rod	X	X	X	X	X

*Used on B Models manufactured since fiscal week 30, 1971.

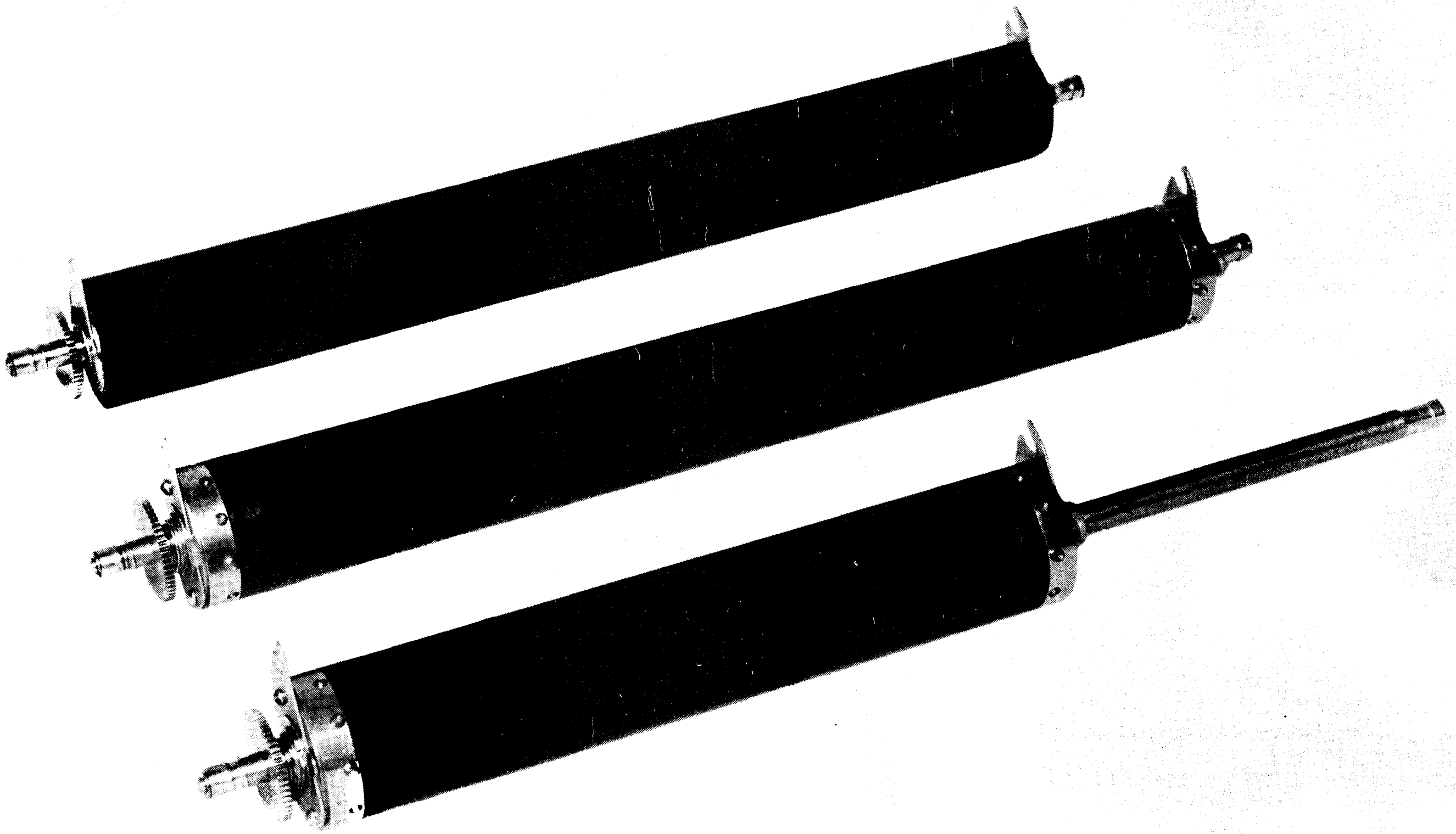

Platens
Figure 45

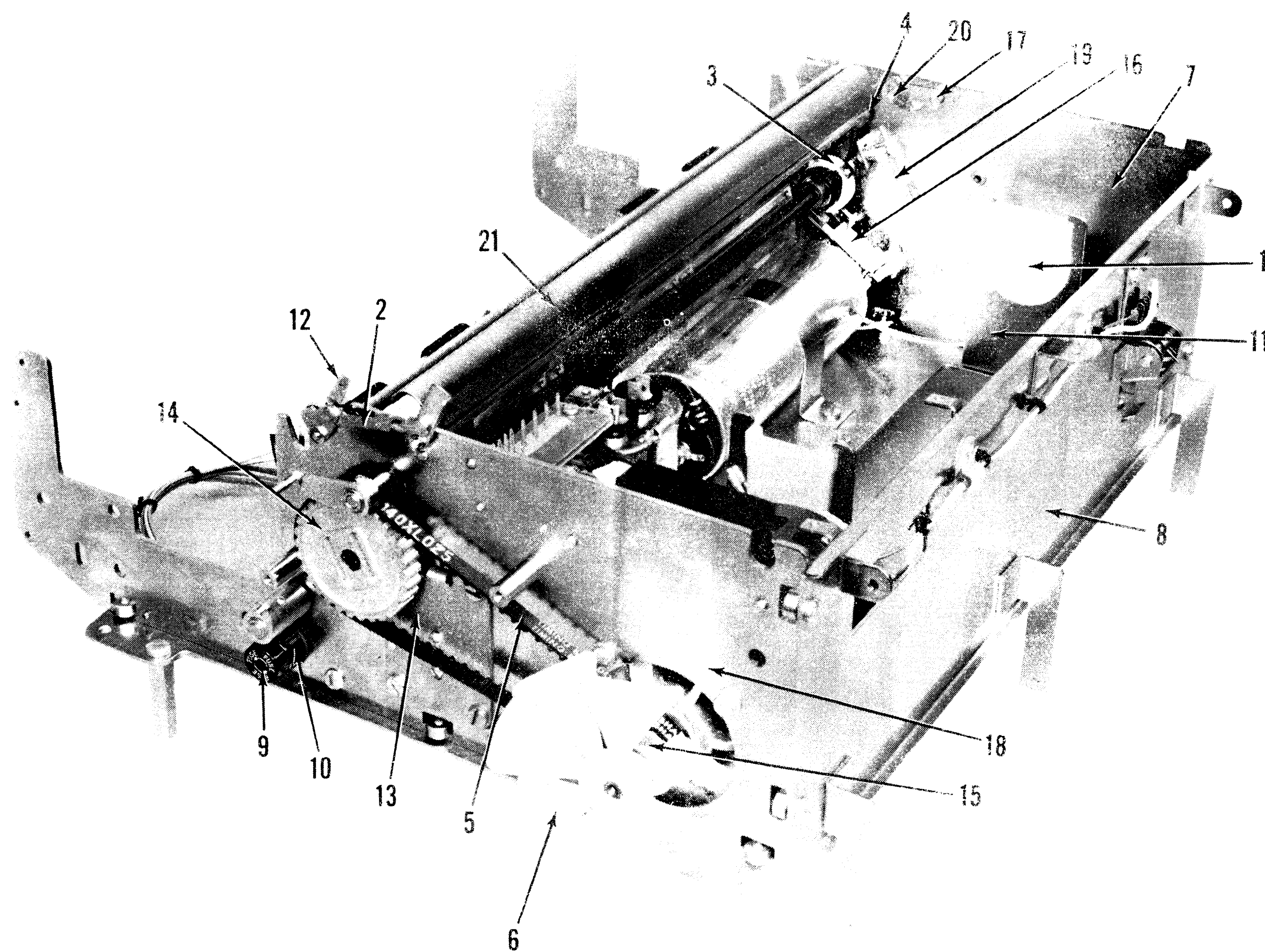

Frame Assembly

Figure 46

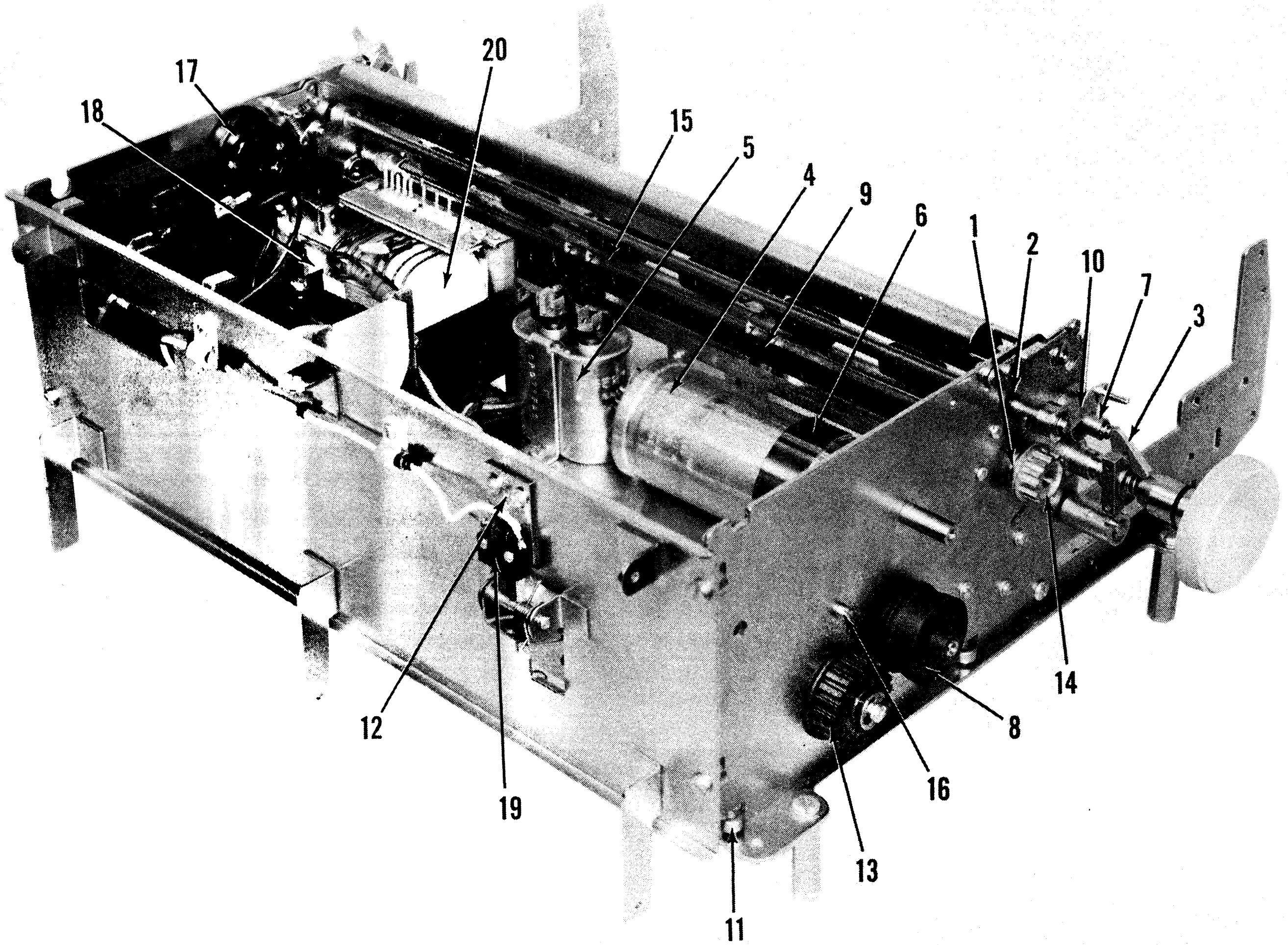

Frame Assembly
Figure 47

2/5/76 171

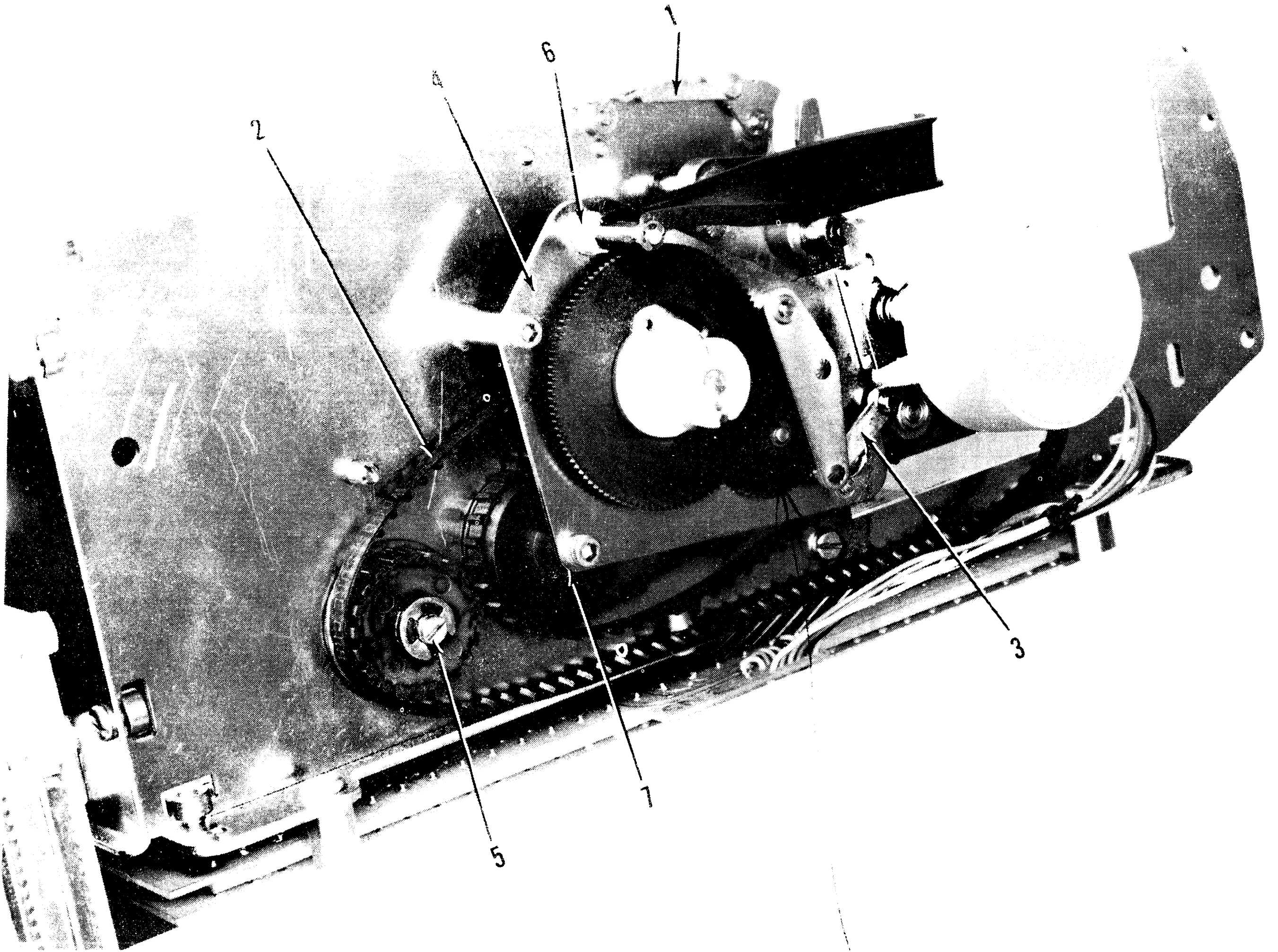

Frame Assembly
Figure 48

GEAR
44B 412604 601

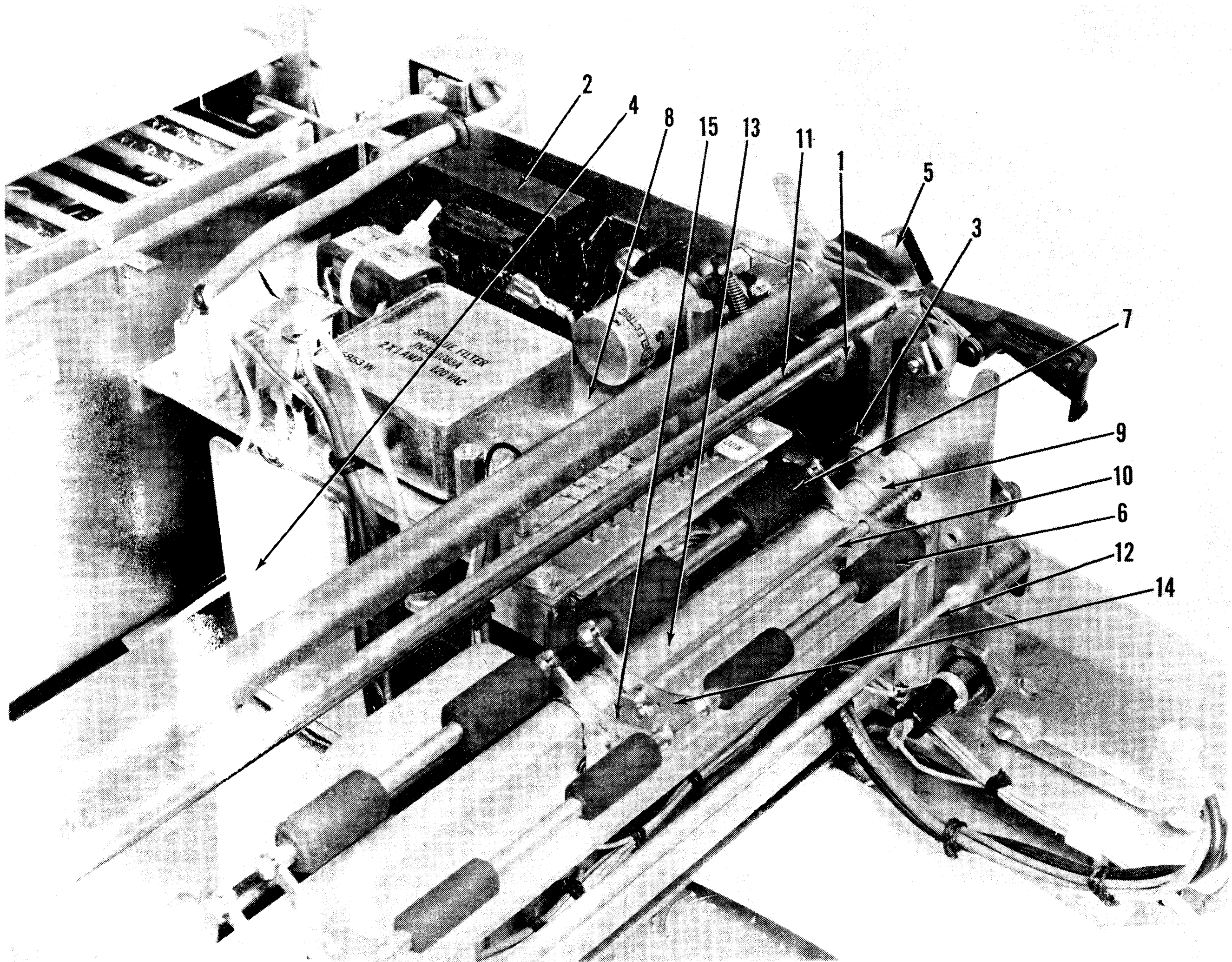

Frame Assembly
Figure 49

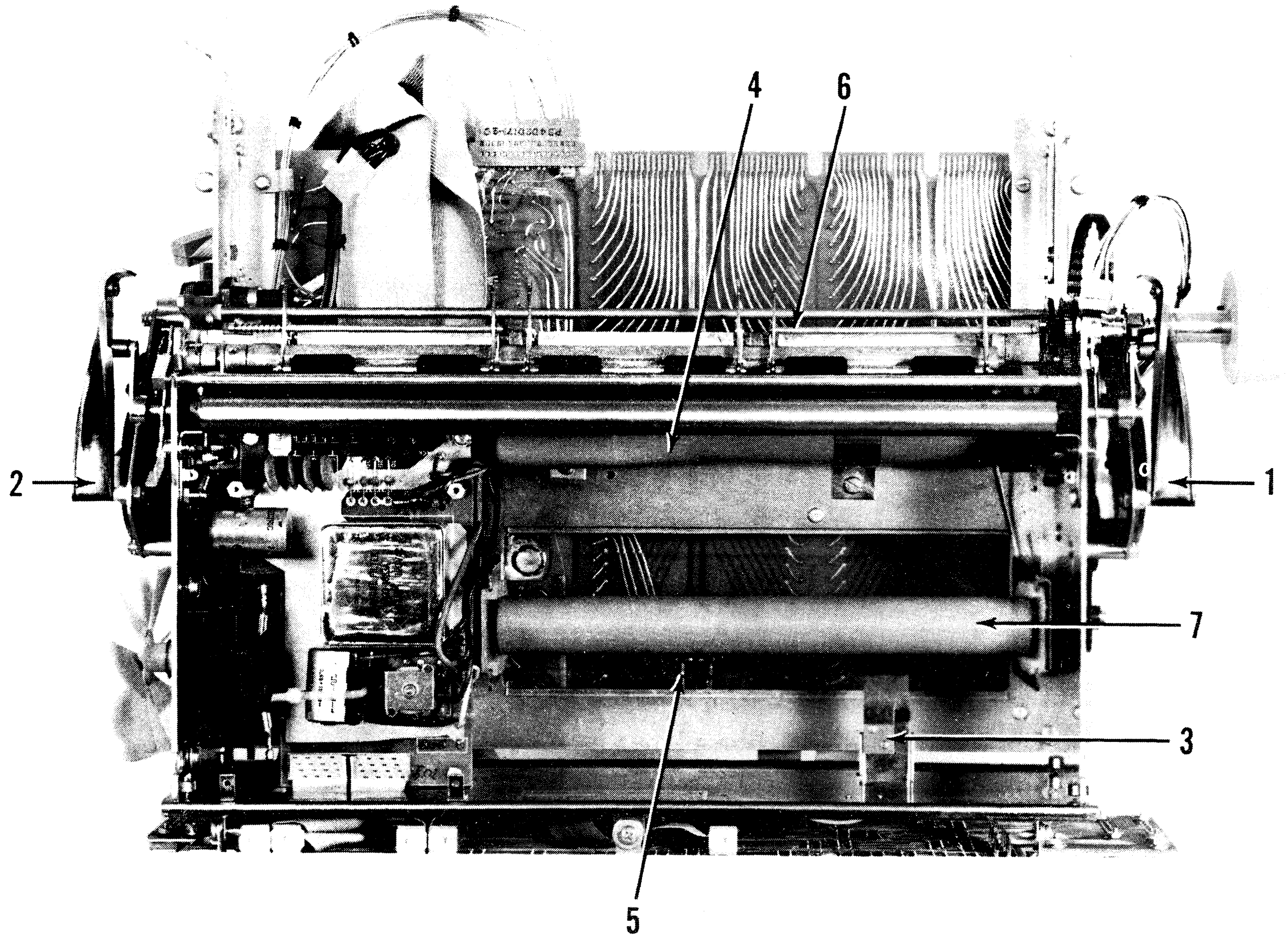

Frame Assembly
Figure 50

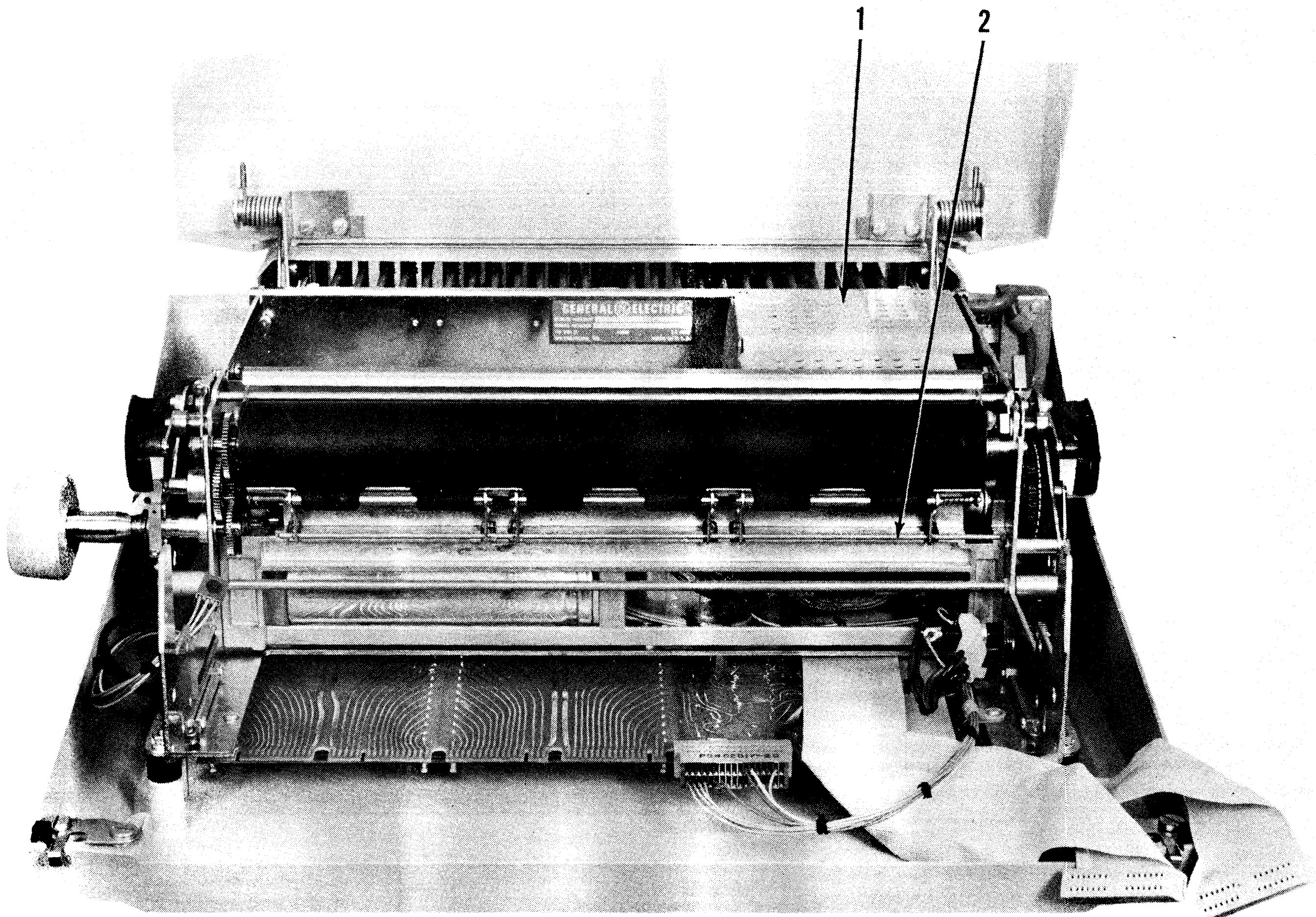

Frame Assembly

Figure 51

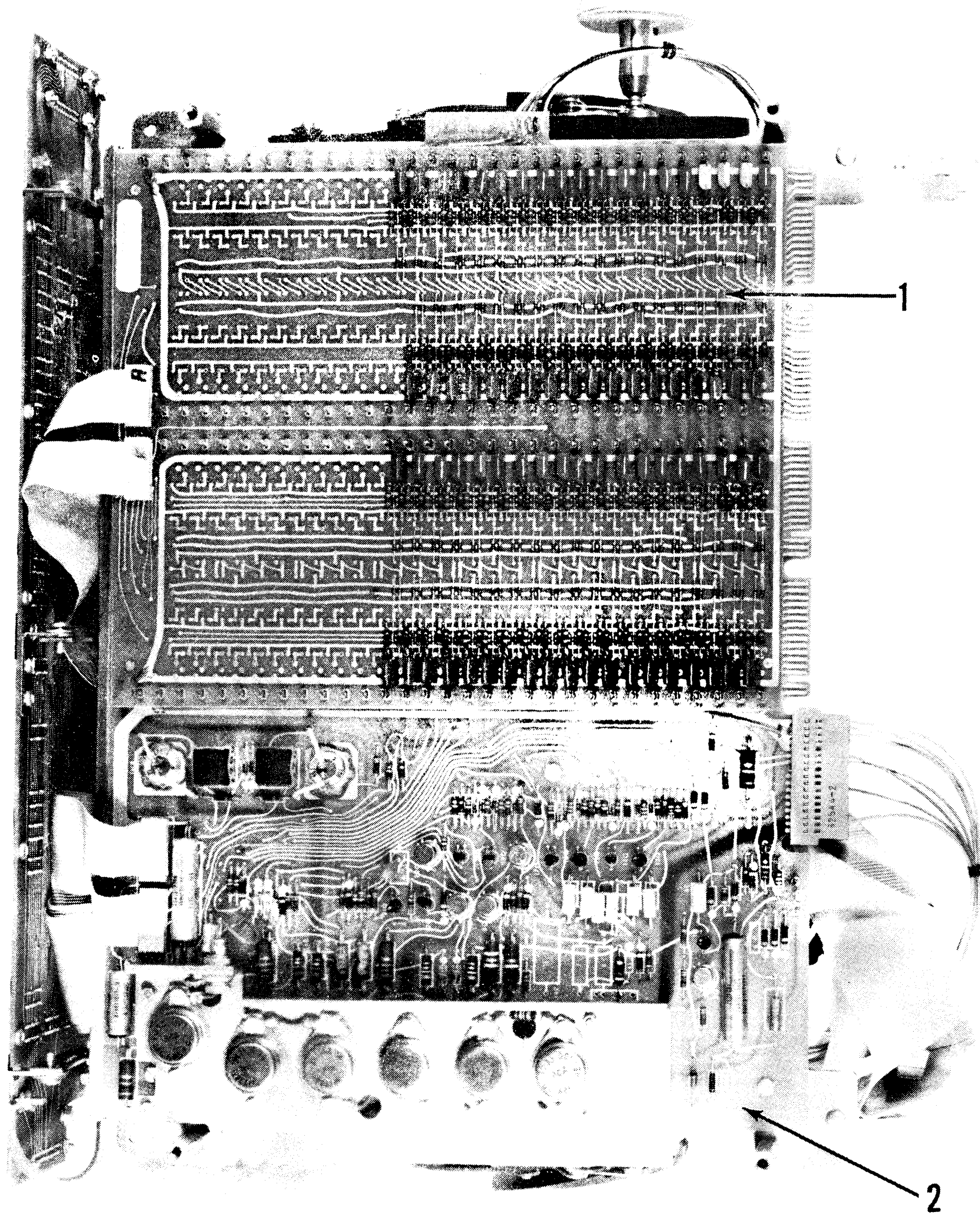

Frame Assembly
Figure 52

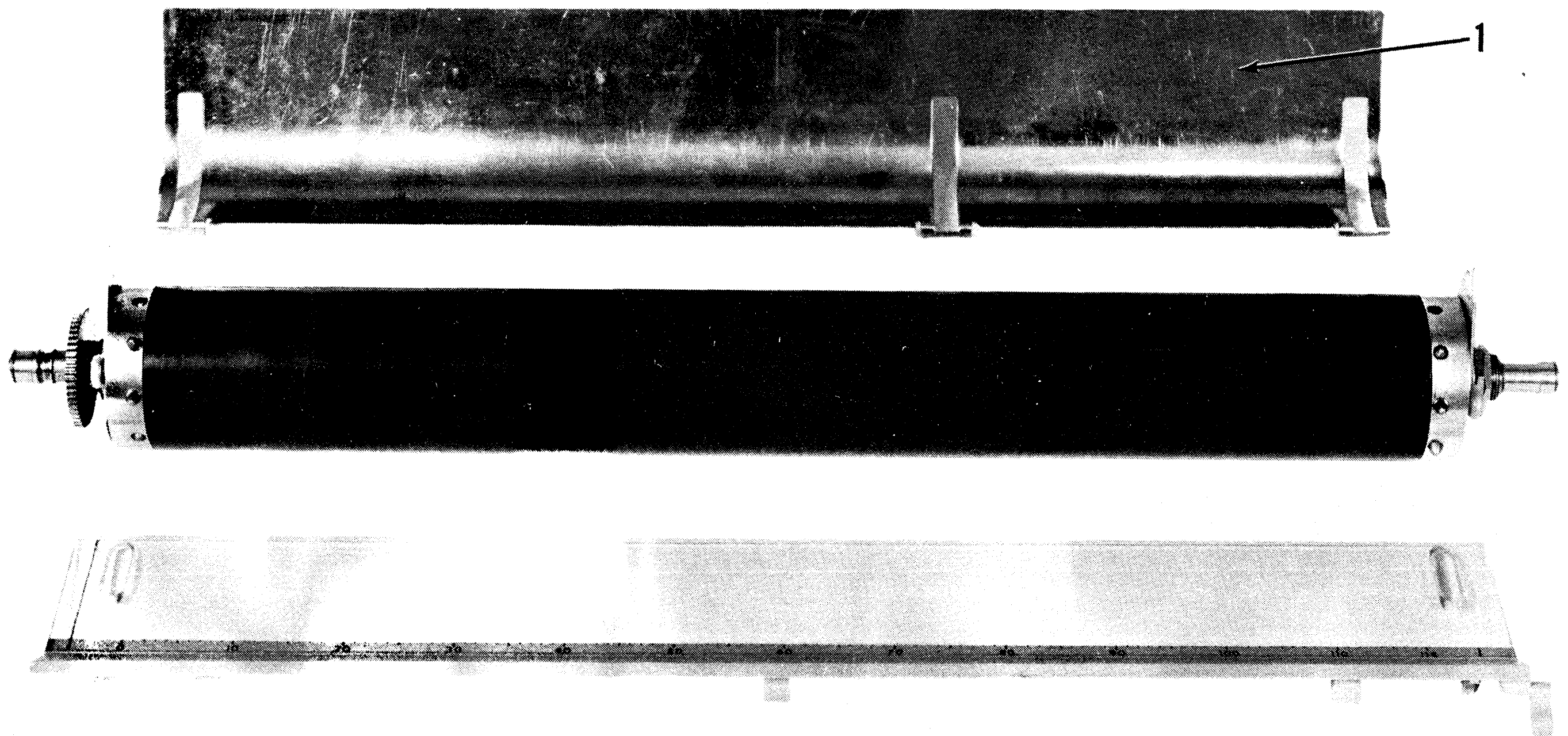

Pin Feed Conversion Kit

Figure 53

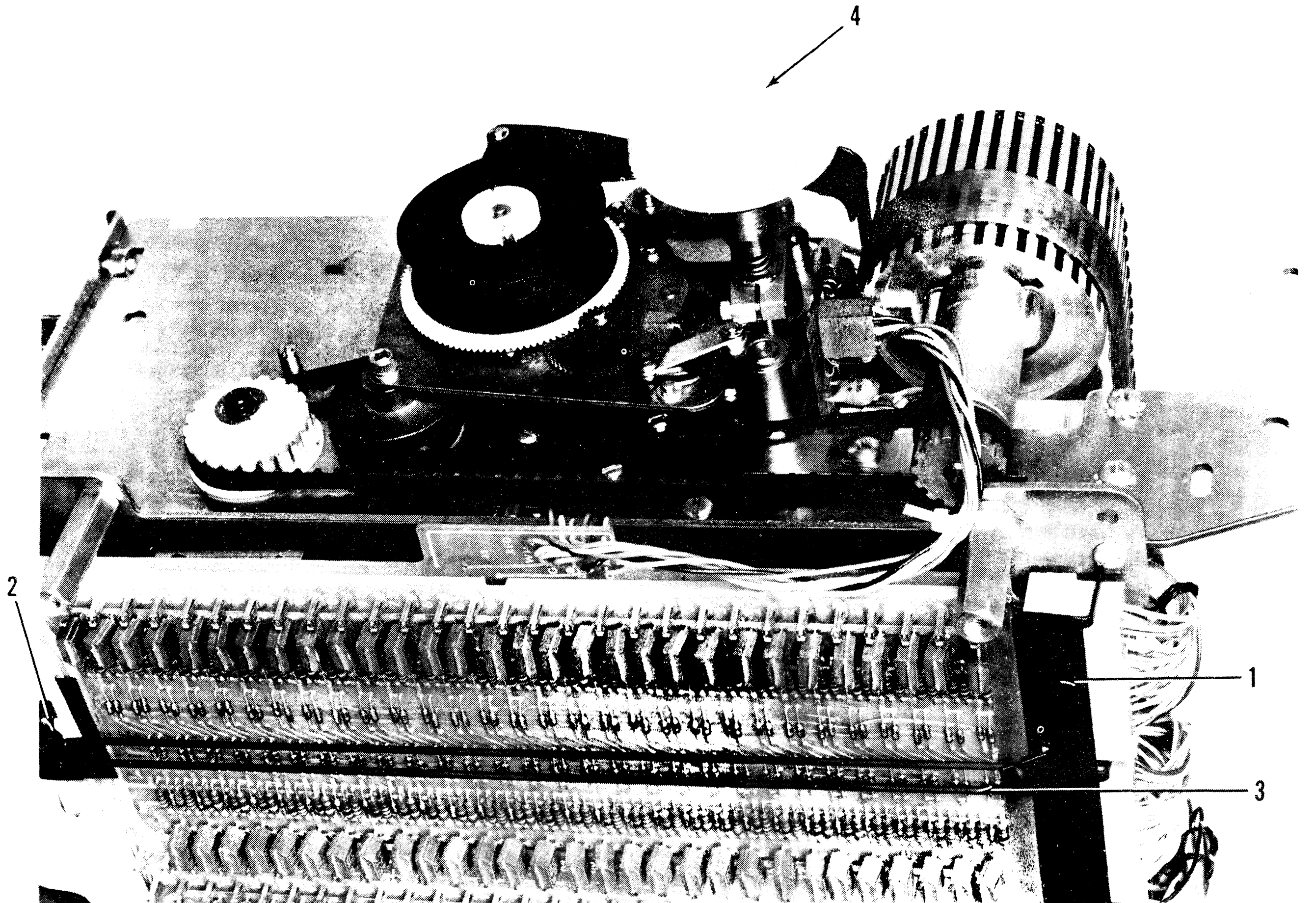

Frame Assembly
Figure 54

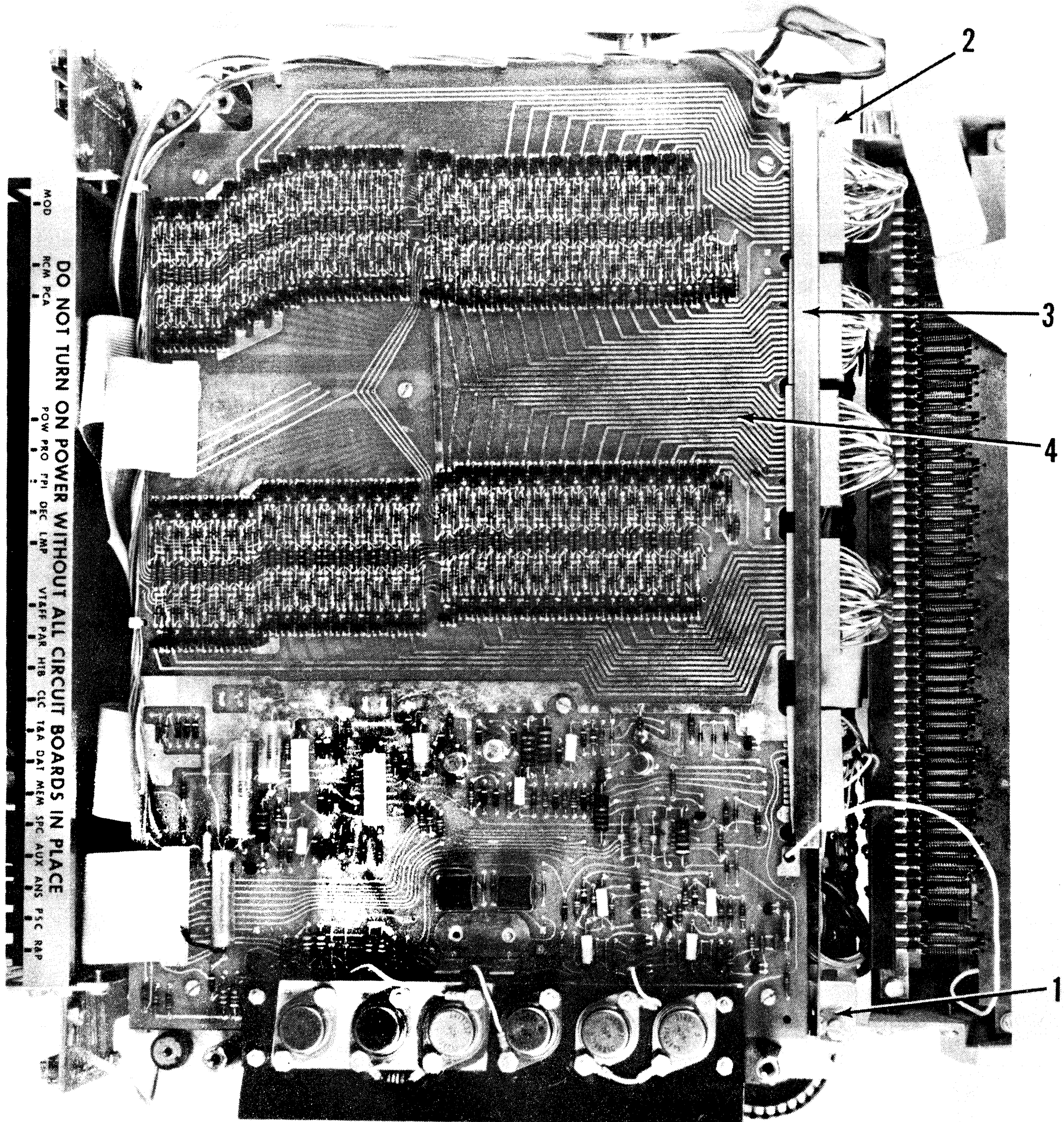

Frame Assembly (Model C)

Figure 55

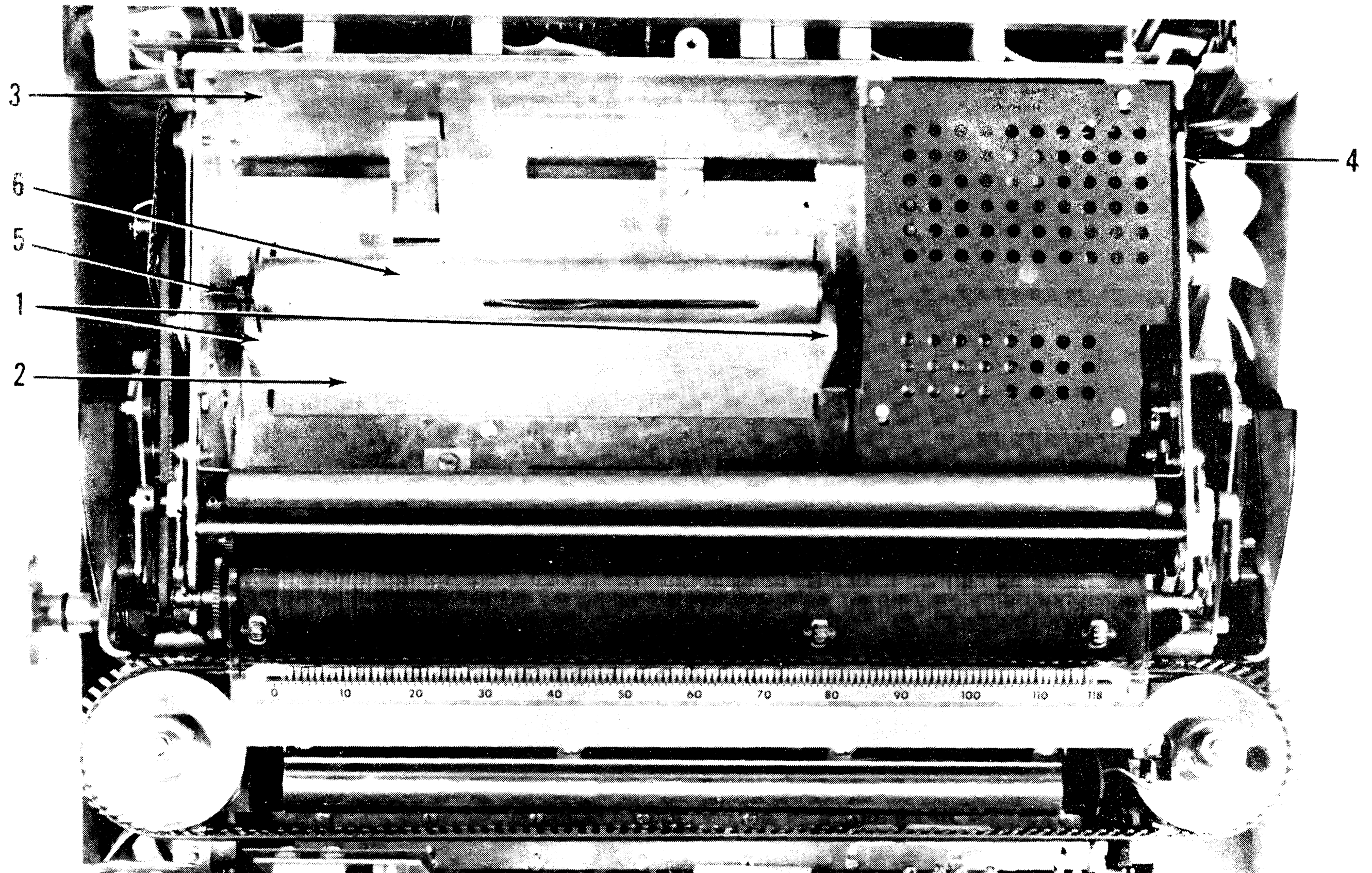

Frame Assembly (Model C)

Figure 56

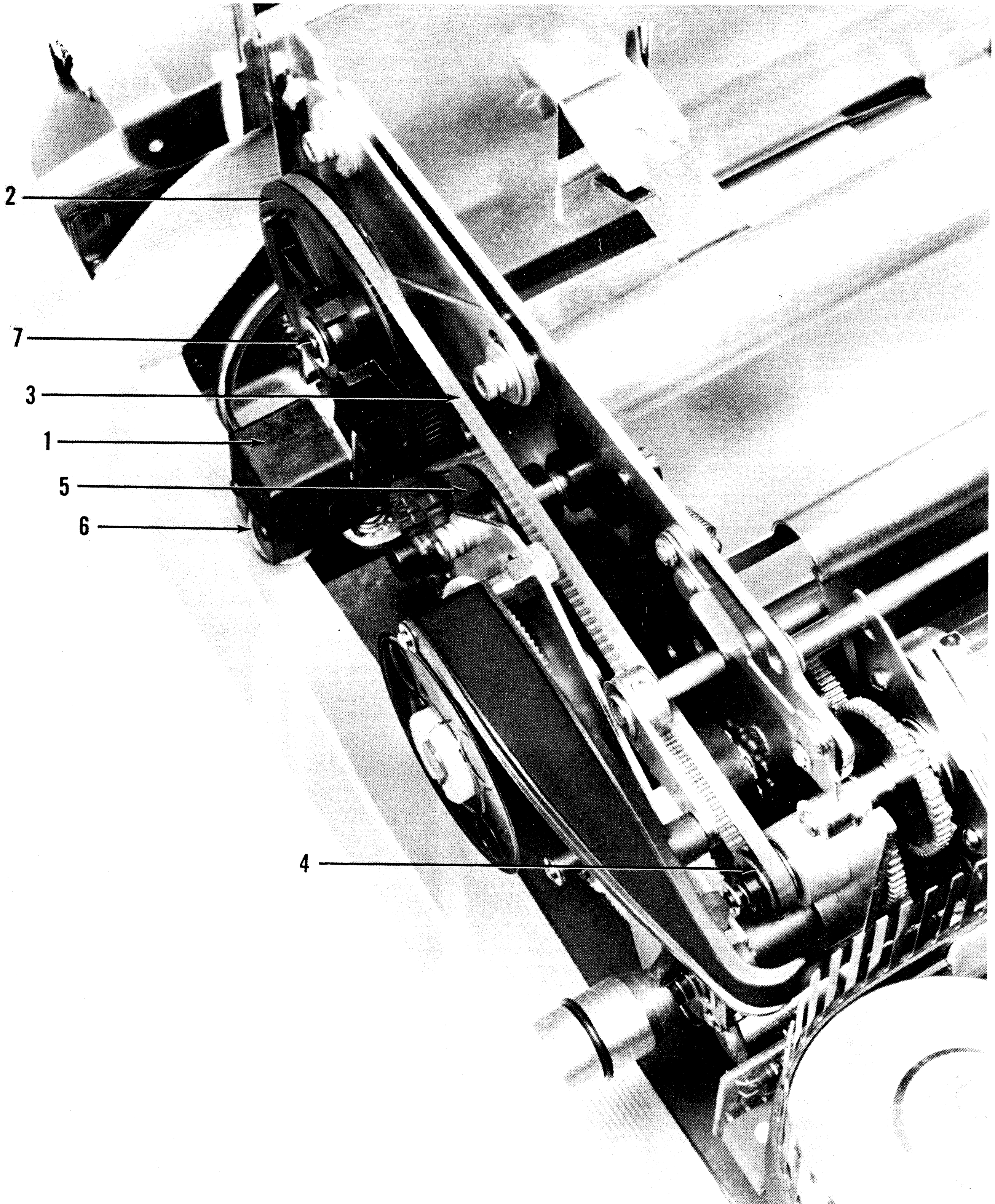

Vertical Tab And Form Feed Assembly

Figure 57

SECTION 6 BUSTLE ASSEMBLY

<u>CODE</u>	<u>FIGURE</u>	<u>PART NO.</u>	<u>DESCRIPTION</u>	<u>KSR</u>	<u>RO</u>	<u>A</u>	<u>B</u>	<u>C</u>
			Boards, Printed Circuit					
● 6117	58-14	44B412153-G01	ANS	X		X	X	
● 6055		44B417405-G01	ANSC	X				X
● 6056		44B417405-G02	ANSC-Auto. Answerback	X				X
● 6046		44B412261-G01	AUX	X			X	
6125	58-8	44B412159-G01	CLC- Standard	X	X	X	X	
6075	58-8	44B412159-G02	CLC-200 Baud Capability	X	X	X	X	
6076		44B412159-G03	CLCC- Standard	X	X	X	X	X
6077		44B412159-G04	CLCC-200 Baud Capability	X	X	X	X	X
6120	58-1	44B412155-G01	DAT1	X	X	X	X	
6121	58-1	44B412155-G02	DAT2- Auto. Motor On/Off	X	X	X	X	
6003		44B417416-G01	DATC	X	X	X	X	X
* 6064		44B417422-G01	DATI	X	X	X	X	X
6127	58-10	44B412160-G01	DEC-75 (Short) Print Line	X	X	X	X	
6128	58-10	44B412160-G02	DEC-118 (Long) Print Line	X	X	X	X	
6086		44B412160-G03	DECC-75 (Short) Print Line	X	X	X	X	X
6081		44B412160-G04	DECC-118 (Long) Print Line	X	X	X	X	X
● 6123	58-11	44B412157-G01	HTB	X	X	X	X	
● 6048		44B412157-G02	HTBC	X	X	X	X	X
6112	58-17	44B412169-G03	KIF	X		X	X	
6087		44B412405-G01	LDI	X				X
6134	58-7	44B412165-G01	LMP	X	X	X	X	
6096		44B412165-G03	LMPC	X	X	X	X	X
6110		44B412167-G01	MB	X		X		
6111		44B412167-G02	MB		X	X		
6147		44B412298-G02	MB	X			X	
6146		44B412298-G04	MB		X		X	
6124	58-12	44B412158-G01	MEM	X	X	X	X	
6070	58-12	44B412158-G02	MEM-Auto. CR End of Line	X	X	X	X	
6071		44B412158-G03	MEMC	X	X	X	X	X
6072		44B412158-G05	MEMC-Red/Blk. Ribbon	X	X			X
● 6142		44A417330-001	MOD	X	X		X	
● 6143		44A417330-003	MOD	X	X		X	X
● 6115	58-6	44B416260-G01	PAR	X	X	X	X	
● 6089		44B417415-G01	PARC	X	X		X	X
6135	58-4	44B412166-G01	PCA	X	X	X	X	
6078		44B412166-G02	PCAC	X	X	X	X	X
6051	58-3	44B412170-G03	POW	X	X	X	X	
6052		44B412170-G04	POWC	X	X	X	X	X
6129	58-2	44B412162-G01	PPI	X		X	X	
6133	58-5	44B412164-G01	PRO	X	X	X	X	
6094		44B412164-G02	PROC	X	X	X	X	X
6118	58-15	44B412154-G01	PSC	X		X	X	
6119	58-15	44B412154-G02	PSC-Line Turn-Around	X		X	X	
6059		44B417409-G01	PSCC	X				X
6060		44B417409-G02	PSCC- Line Turn-Around	X				X
● 6130	58-16	44B412163-G01	R & P Stops RDR. on DC3. Transmits DC3 on Startup	X		X	X	
● 6091	58-16	44B417408-G02	R & P - Transmits then Stops RDR. on DC3.	X		X	X	

● Option PCB's

<u>CODE</u>	<u>FIGURE</u>	<u>PART NO.</u>	<u>DESCRIPTION</u>	<u>KSR</u>	<u>RO</u>	<u>A</u>	<u>B</u>	<u>C</u>
● 6090		44B11P103-005	R & DC- Stops RDR. on DC3. Transmits DC3 on Startup	X			X	X
● 6092		44B11P103-006	R & DC- Transmits then Stops RDR. on DC3.	X			X	X
6067		44B11P103-007	SPCC	X	X	X	X	X
6122	58-11	44B11P103-008	SPCC	X	X	X	X	
6128	58-12	44B11P103-009	T & A	X	X	X	X	
6084		44B11P103-010	Y & P	X	X	X	X	X
● 6044		44B11P103-011	Y & P	X		X	X	X
● 6031		44B11P103-012	T & A	X	X		X	
● 6032		44B11P103-013	T & A	X	X		X	X
6105	58-14	44B11P103-014	Change Bustle Board	X	X	X	X	X
6000	58-1	44B11P103-015	Cover Bustle	X	X	X	X	
6005	60-1	44B11P103-016	Cover Bustle	X	X			X
*6100	58-15	44B11P103-017	Frame Assembly	X		X		
*6102		44B11P103-018	Frame Assembly		X	X		
*6104		44B11P103-019	Frame Assembly	X			X	
*6107		44B11P103-020	Frame Assembly		X		X	
*6108	61-1	44B11P103-021	Frame Assembly	X				X
*6109		44B11P103-022	Frame Assembly		X			X
6153		44B11P103-023	Fuse- 1/8A (CLC, T & A)	X	X	X	X	X
6154		44B11P103-024	Fuse- 3/8A (LMP)	X	X	X	X	X
6155		44B11P103-025	Fuse- 3/4A (POW)	X	X	X	X	
6156		44B11P103-026	Fuse- 1 1/2A (POW)	X	X			X
6113	58-20	44B11P103-027	Switch, All Caps (KIF)	X		X	X	

*Mother Board Included

BUSTLE ASSEMBLY

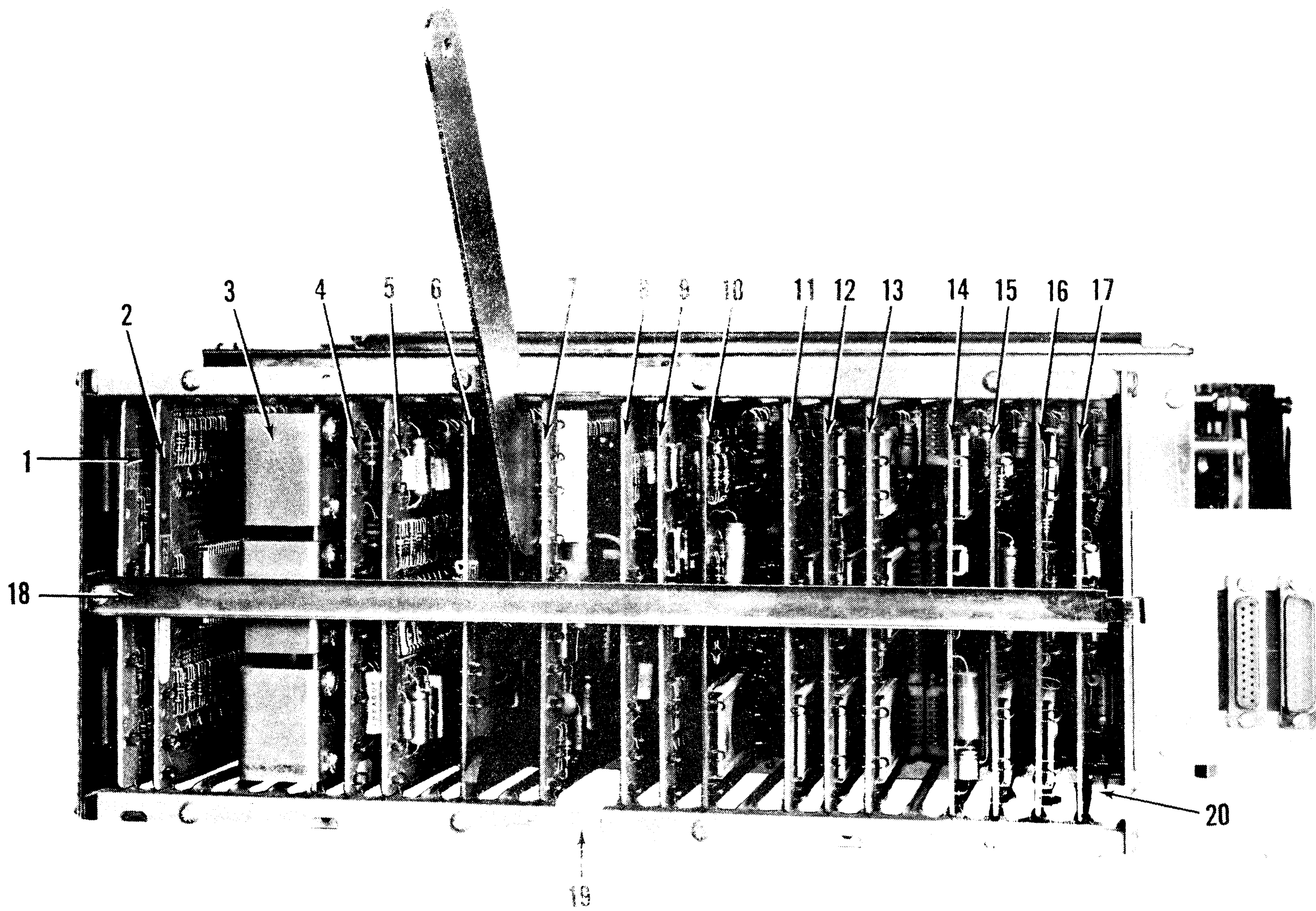

Bustle Assembly
Fig. 50

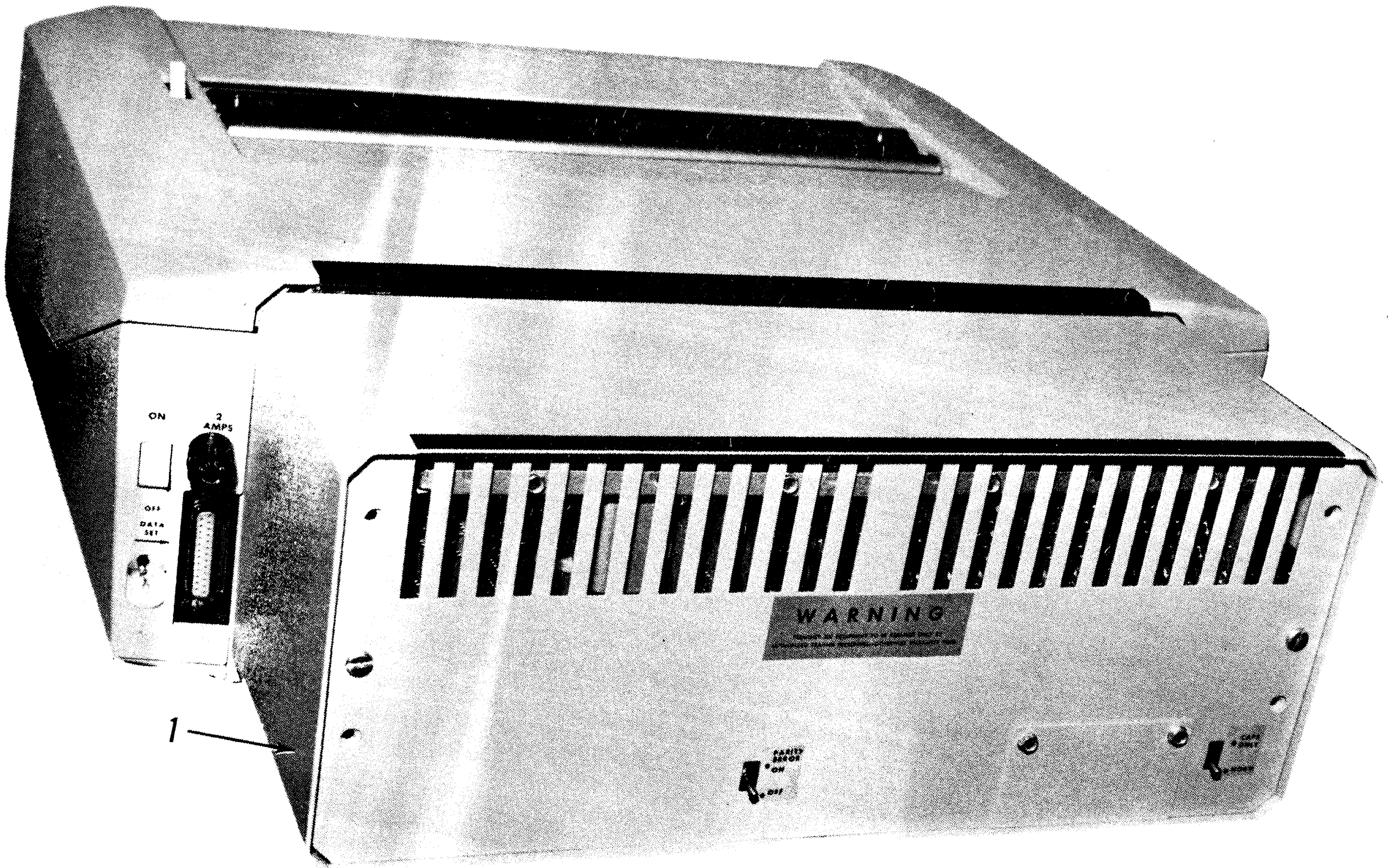

Bustle Cover (Models A and B)
Figure 59

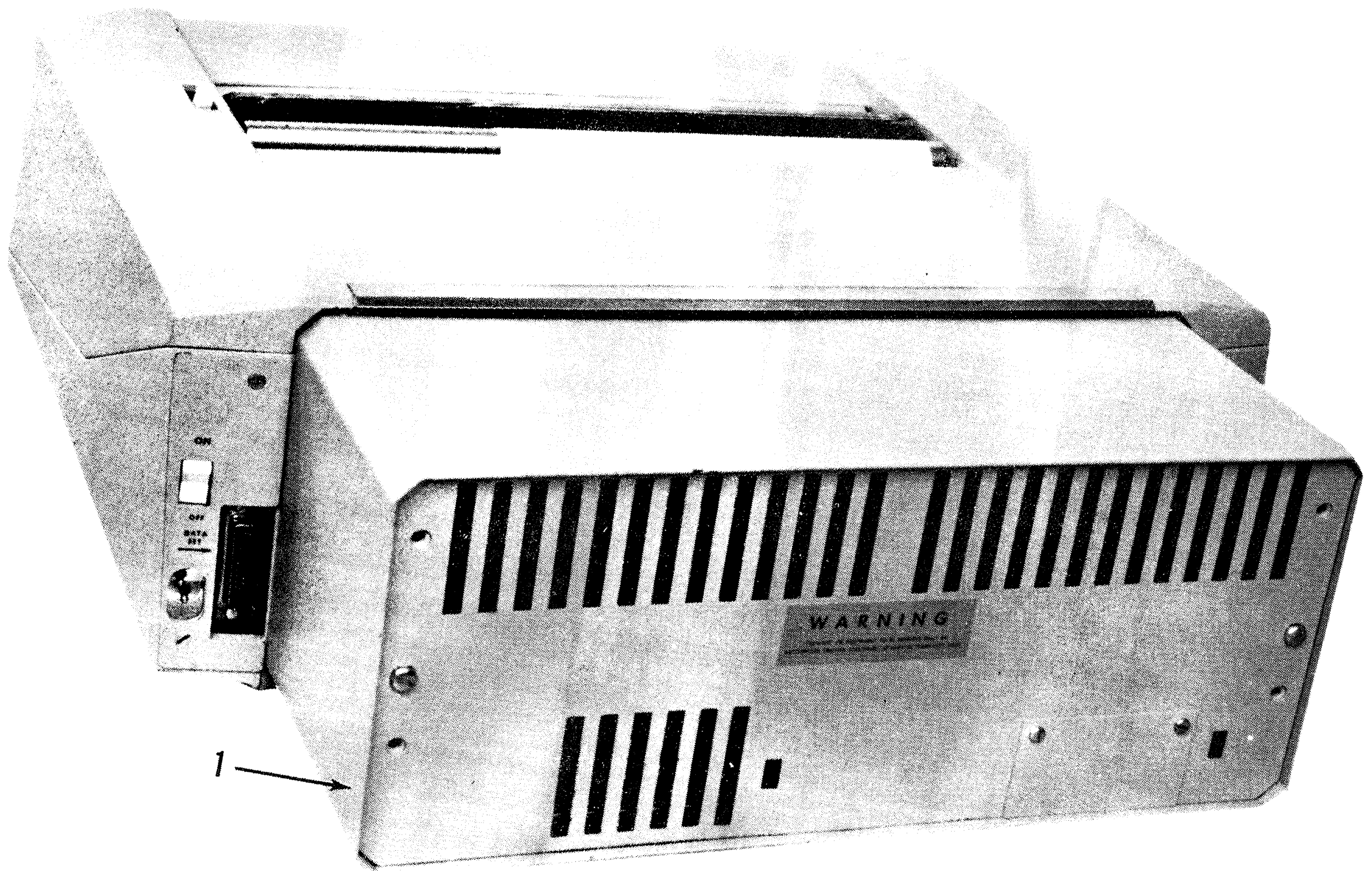

Bustle Cover (Model C)
Figure 60

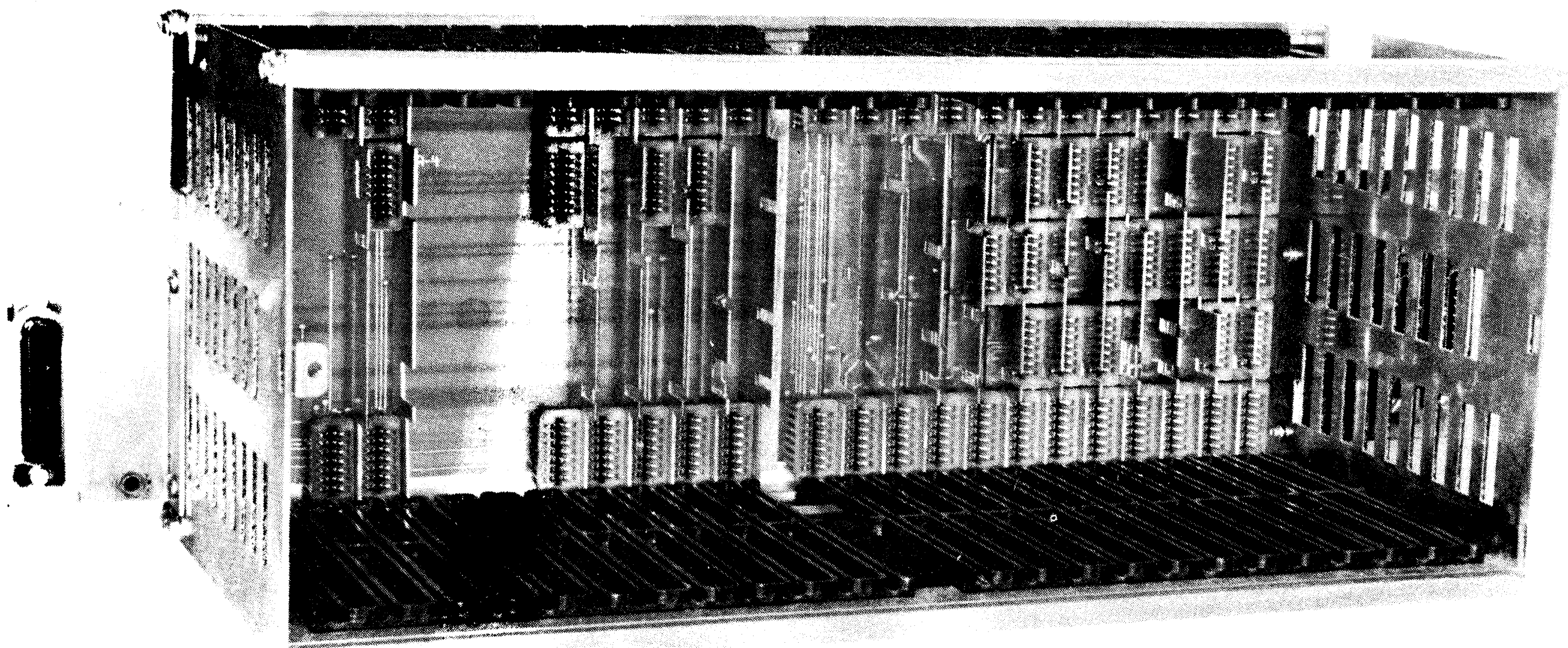

Bustle Frame (Model C)
Figure 61

DOCUMENT REVIEW SHEET

TITLE: Terminet 300 Printer Parts Manual

PUB. #: GEK-14999B

From:

Name: _____

Position: _____

Address: _____

Comments concerning this publication are solicited for use in improving future editions. Please provide any recommended additions, deletions, corrections, or other information you deem necessary for improving this manual. The following space is provided for your comments.

COMMENTS: _____

NO POSTAGE NECESSARY IF MAILED IN U.S.A.

Fold on two lines shown on reverse
side, staple, and mail.

PLEASE CUT ALONG THIS LINE

Staple

Staple

FOLD

FIRST CLASS
PERMIT
NO. 124
Waynesboro, Va.

BUSINESS REPLY MAIL
NO POSTAGE NECESSARY IF MAILED IN THE UNITED STATES

DATA COMMUNICATION PRODUCT SALES
General Electric Company
Data Communication Products Dept.
Waynesboro, Virginia 22980

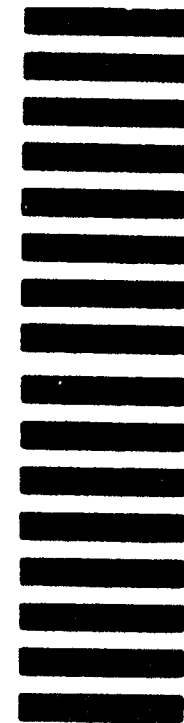

FOLD

3-72 (1500)

Data Communication Products Department • General Electric Company
Waynesboro, Virginia 22980

PRINTED
IN
U.S.A.

GENERAL  ELECTRIC

(SERVICE AIDS)

<u>CODE</u>	<u>FIGURE</u>	<u>PART NO.</u>	<u>DESCRIPTION</u>	<u>KSR</u>	<u>RO</u>	<u>A</u>	<u>B</u>	<u>C</u>
0042		44B412451-G01	Cable, Cheater	X	X			X
*0043		44B412451-G02	Cable, Cheater	X	X	X	X	
0003	16-	44A417322-001	Case, Carrying					
0004	9-1	44B412262-G01	Extender, Bustle Board					
0005	10-1	44A410368-G01	Extractor, Bustle Board					
0006	11-1	44B412269-001	Extractor, Type Finger					
0065	12-	44A410583-001	Gage, Pulley Alignment					
0066	13-	44A410619-G01	Gage, Timing					
0067		44A410695-G01	Graphite, Print Belt					
0069		A15B41H	Loctite**					
0070		44A417371-001	Lubricant, Print Belt					
0071	14-	44A410618-G01	Plug, Test					
0072	15-	44A410588-G01	Puller, Bearing					

* For Model A and B Printers, G01 cable also required.

** Registered trademark of Loctite Corporation

MANUALS

0037	GEK-35968	Beginner's Guide	X		X	X	
0038	GEK-35970	Beginner's Guide	X				X
0009	GEH-2184	Operator's Manual	X		X	X	X
0008	GEK-15002	Programmer's Manual	X		X	X	X
0010	GEH-2185A	Service Manual	X			X	X

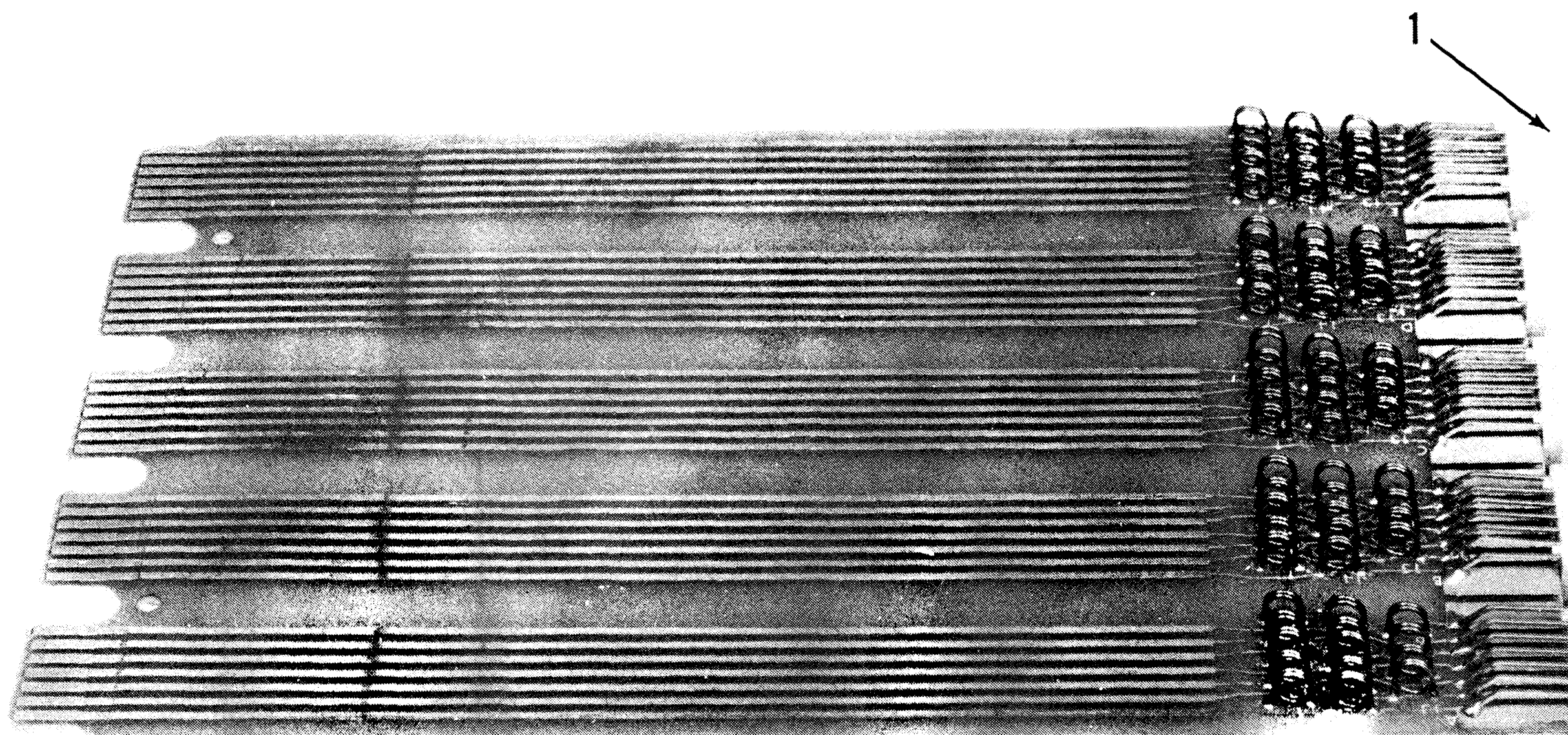

Bustle Board Extender

Figure 9

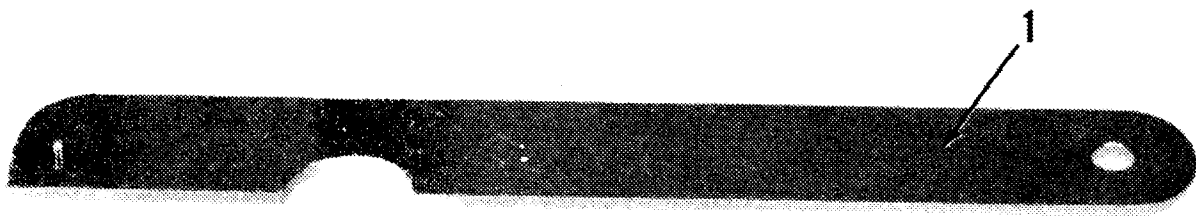

Bustle Board Extractor
Figure 10

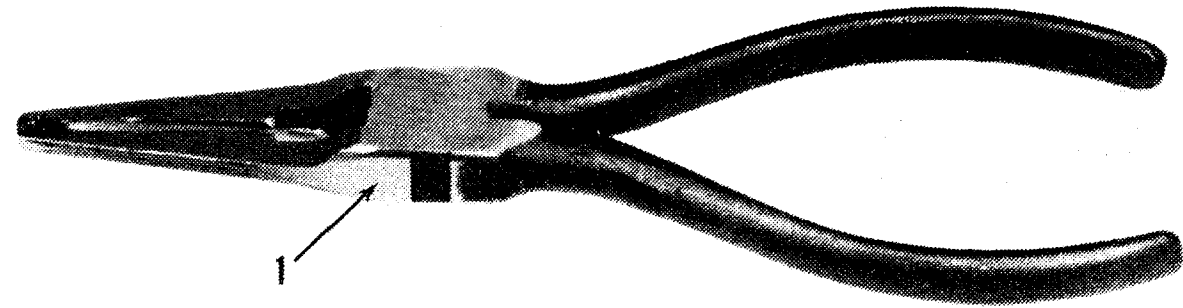

Type Finger Extractor
Figure 11

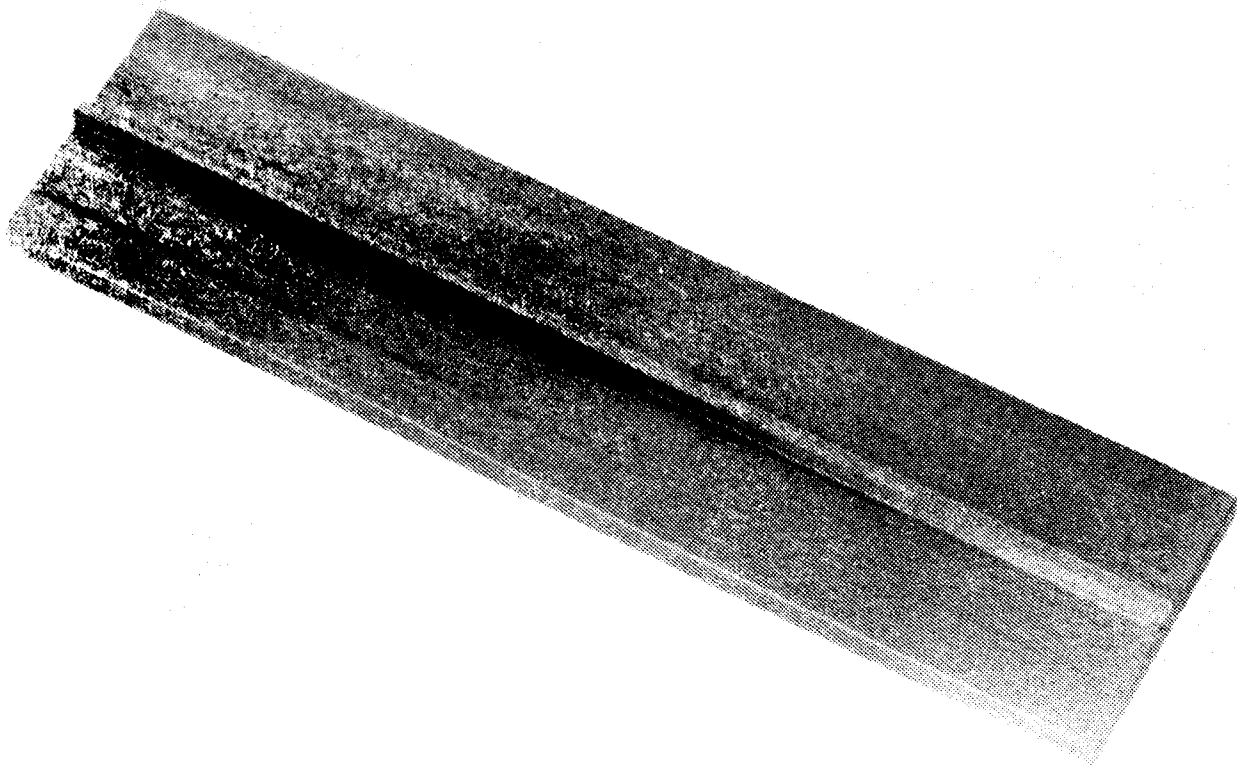

Pulley Alignment Gage
Figure 12

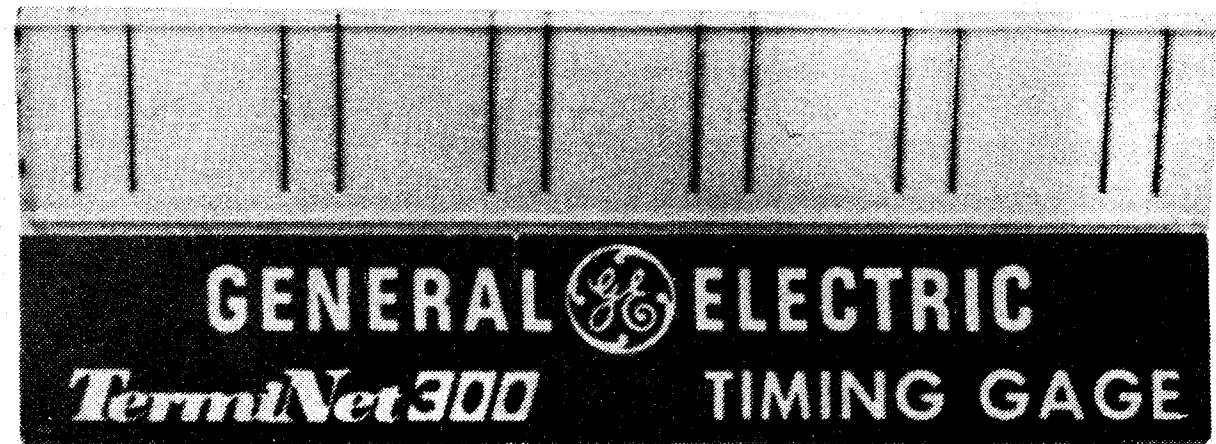

Timing Gage
Figure 13

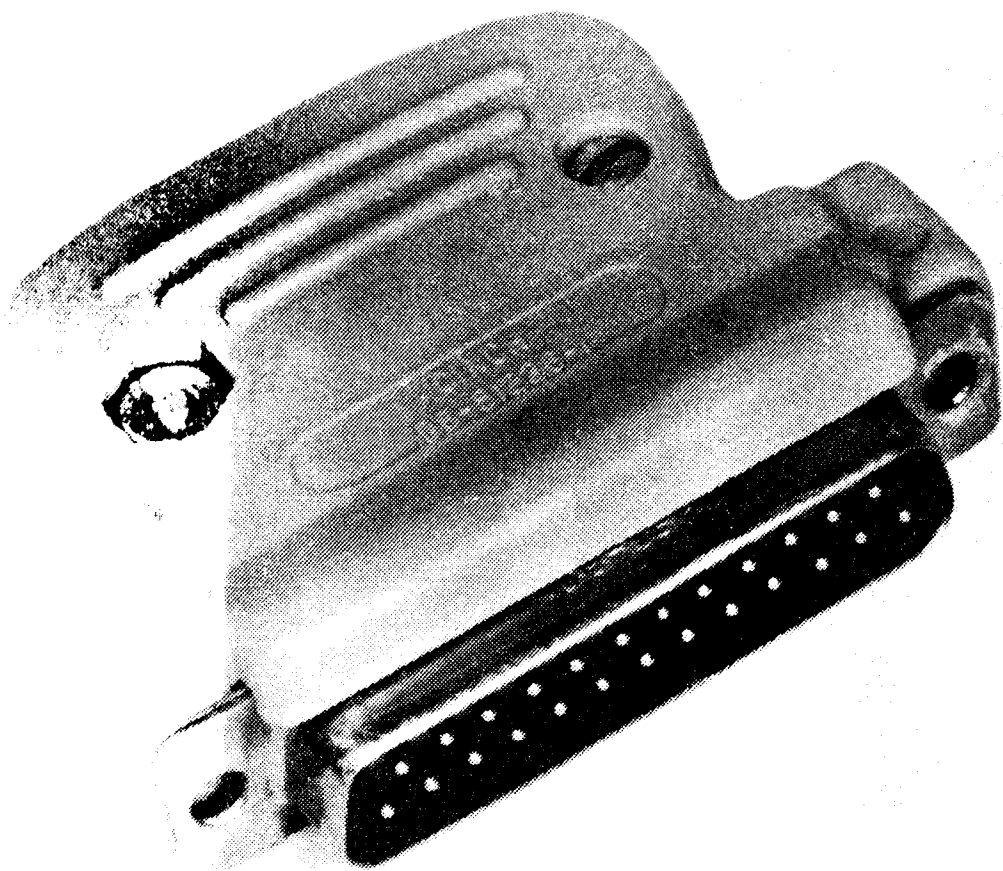

Test Plug
Figure 14

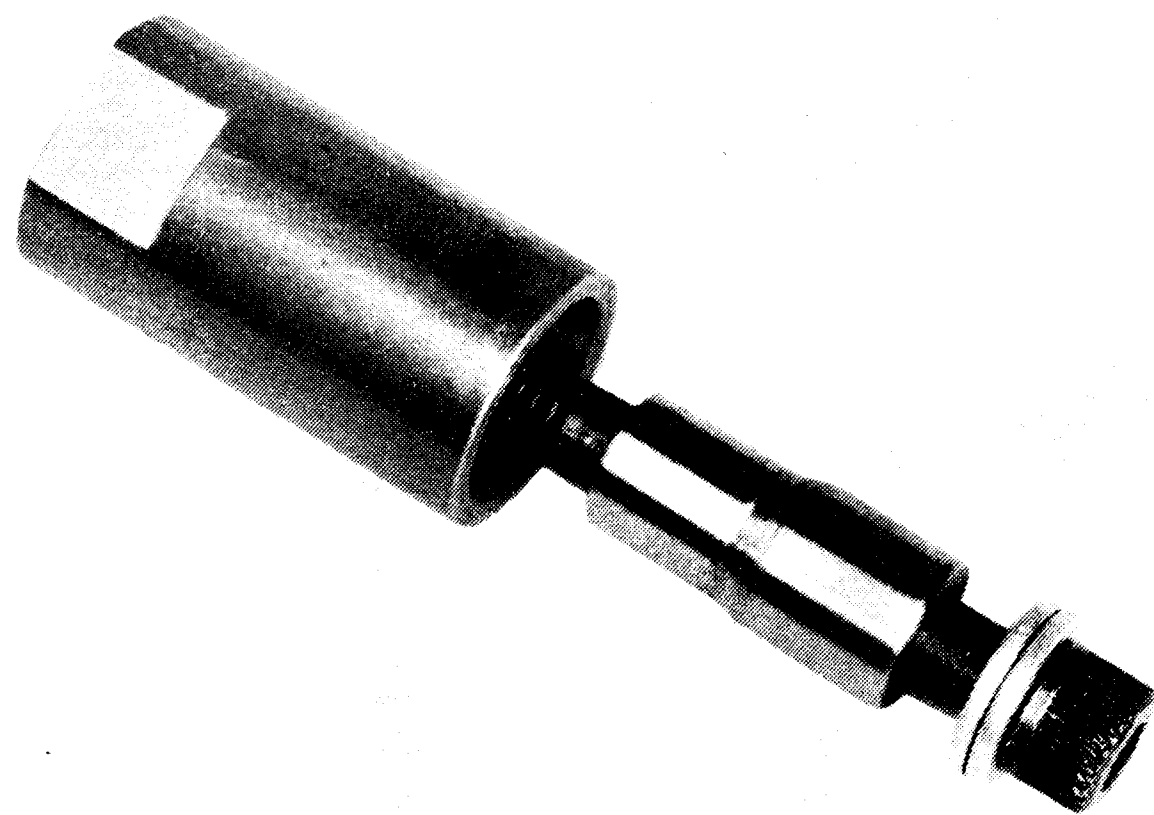

Bearing Puller
Figure 15

TermiNet[®] 3000

DATA
COMMUNICATION
PRINTER

STANDARD PARTS KIT FOR MODEL B MACHINE

PART NUMBER

44B412247-G06 Parts Kit

The following listed parts are available in kit form to provide service support on standard ASR and KSR models. These parts are available as a kit or by individual purchase from the regular catalog. Option boards must be ordered separately to augment this standard kit when the user has an ASR model or has special options on his KSR model.

<u>KIT</u> <u>QTY.</u>	<u>MACH.</u> <u>QTY.</u>	<u>PART NO.</u>	<u>DESCRIPTION</u>	<u>LOCATED</u>
1	1	44D415501-G01	Photocell Preamp (PC)	Under lf. side of Print Belt
1	1	44B412022-G01	Keyboard Sense-Line Driver	Inside Keyboard
1	1	44B412156-G01	S/P Converter (SPC)	Bustle
1	1	44B412158-G02	Memory & Write Cont. (MEM)	Bustle
1	1	44B412159-G01	Clock & Cycle Cont. (CLC)	Bustle
1	1	44B412160-G02	Serial Decoder (DEC)	Bustle
1	1	44B412161-G01	Timing & Alarm (T&A)	Bustle
1	1	44B412162-G01	Print Pos. Indicator (PPI)	Bustle
1	1	44B412164-G01	S/T Protection (PRO)	Bustle
1	1	44B412165-G01	Lamp Regulator (LMP)	Bustle
1	1	44B412166-G01	Photocell Amp (PCA)	Bustle
1	1	44B412168-G01	H.V. Power Supply (TXP)	Over Motor
1	1	44B412169-G03	Keyboard Interface (KIF)	Bustle
1	1	44B412170-G03	L.V. Power Supply (POW)	Bustle
1	1	44A410227-G01	Switch, Shield	Rt. side of shield
1	1	44A417036-001	Switch, Cover Interlock	Rt. back of bottom cover
1	1	44A417037-001	Switch, Input Power	Rt. back bottom cover
1	3	44A417038-001	Switch, Toggle 2 Pos.	Front Cont. Panel
1	2	44A417039-001	Switch, Toggle 3 Pos.	Front Control Panel
1	7	44A417058-501	Switch, Pushbutton	Front Cont. Panel
2	3	44A417054-001	Digital Readout	Front Cont. Panel
5	7	327	Lamp, Control Panel	Front Cont. Panel
2	1	44A417008-001	Bearing, Jack Shaft (Rt.)	Rt. side frame
2	1	44A410515-001	Bearing, Jack Shaft (Lf.)	Lf. side frame
2	4	44B232214-003	Bearing, Flanged	Lf. & Rt. Belt Pulley
1	1	44A410166-G02	Line Feed Relay	Inside Lf. Frame
1	1	44B417108-001	L.F. Clutch	Lf. side Jack Shaft
1	1	44A410246-G01	Ribbon Lift Asm.	Inside Rt. frame
4	1	44A417013-002	Ribbon with Spools	
1	1	44D415570-G01	Ribbon Mech. L.F.	Lf. outside of frame
1	1	44D415571-G01	Ribbon Mech. RT.	Rt. outside of Frame
1	1	44A417024-001	Drive Belt - LF	Outside Lf. Frame
1	1	44A417024-002	Drive Belt - RT	Outside Rt. Frame
1	1	44B412321-001	Pulley, Jack Shaft (Rt.)	Outside Rt. Frame
1	1	44B412072-001	Pulley, Jack Shaft (Lf.)	Outside Lf. Frame

<u>KIT</u> <u>QTY.</u>	<u>MACH.</u> <u>QTY.</u>	<u>PART NO.</u>	<u>DESCRIPTION</u>	<u>LOCATED</u>
10	61	44A355938-001	Ferrite "U" Core	Senseline
2	56	44A410016-G01	Ferrite Clip	Upper Keyboard
5	5	44A410376-G01	Ferrite Clip, Shimmed	Shift-Rpt-CTL, ESC
1	2	44B412205-G08	Type 1 STD Font	In Print Belt
14	56	44A417044-003	Connector (POST)	Rt. Side Cont. Panel
2	8	44A417044-002	Connector (Insulator)	Rt. Side Cont. Panel
1		44A410466-G02	Fuse Asst. (1)	
1	0	A15B41H	Loc. Tite (A)	
1	1	44A410320-G01	Screws-Nuts-Washers	
1	1	44A410321-G01	Spring-Shim Assort.	

NOTE: The following boards are required to operate any model TermiNet 300 Printer. Since there are several versions of each, select the appropriate version to fit your model machine as a supplementary addition to this kit from the option list below.

OPTION BOARDS (NOT PART OF KIT - ORDER AS SUPPLEMENT TO THE KIT)

1	44C414064-G01 -G02	Hammer Decoder	Under Frame
1	44B412154-G01 or	P/S Converter (PSC) (w/o Turnaround)	Bustle
1	44B412154-G02	P/S Converter (PSC) (with Turnaround)	Bustle
1	44B412428-G01	Dataset (DATB)	Bustle

These boards and parts are not part of the Standard Spare Parts Kit but should be added to the standard kit as needed to support the TermiNet 300 Printer options.

1	44B903048-001	VTFF Punched Discs	Left Side Frame
1	44B412153-G01	Answerback (ANS)	Bustle
1	44B412157-G01	Horizontal Tabl (HTB)	Bustle
1	44B412160-G01	Serial Decoder (DEC)	Bustle
1	44B412163-G01	Reader & Punch (R&P)	Bustle
1	44B412260-G01	Parity Error (PAR)	Bustle
1	44B412261-G02	Auxiliary (AUX)	Bustle
1	44B412360-G01	Reader (RDR)	Console Reader Dwr.
1	44B412381-G01	Punch (PCH)	Console Punch Dwr.
1	12866	Lamp Reader Bulb	Reader Head
1	44B412372-G02	VTFF Bd.	Bustle
1	44C414063-G01	HDA Bd.	Under Frame
1	44B412298-G02	Mother Board	Bustle
1	44A417330-001	Modem Board (MOD)	Bustle
1	44C414110-G01	VTFF Kit (Includes VTFF Bd.)	Left Frame and Bustle
1	44B412411-G01	Selective Addressing (ASK)	Bustle

TermiNet^{*} 3000

DATA
COMMUNICATION
PRINTER

"C" MODEL SPARE PARTS KIT

PART NUMBER

44B412247-G12 Parts Kit

The following listed parts and special tools are available in kit form to provide service support on Model C ASR and KSR units. These items are available as a kit or by individual purchase from the regular catalog.

<u>KIT</u> <u>QTY.</u>	<u>MACH.</u> <u>QTY.</u>	<u>PART NO.</u>	<u>DESCRIPTION</u>	<u>LOCATED</u>
1	1	44D415501-G01	Photocell Preamp (PC)	Under Lf. Side of Print Belt
1	1	44B412470-G01	Sense Line Driver SLC	Inside Keyboard
1	1	44B412156-G02	S/P Converter (SPCC)	Bustle
1	1	44B412158-G03	Memory & Write Cont. (MEMC)	Bustle
1	1	44B412159-G03	Clock & Cycle Cont. (CLCC)	Bustle
1	1	44B412160-G04	Serial Decoder (DECC)	Bustle, 118 Column
1	1	44B412161-G02	Timing & Alarm (T&AC)	Bustle
1	1	44B412405-G01	Light Diode Indicator LD1	Bustle
1	1	44B412164-G02	S/V Protection (PROC)	Bustle
1	1	44B412165-G03	Lamp Regulator (LMPC)	Bustle
1	1	44B412166-G02	Photocell Amp (PCAC)	Bustle
1	1	44B417406-G01	H.V. Power Supply Bd. (TXPC)	Over Motor
1	1	44B412170-G04	L.V. Power Supply (POWC)	Bustle
1	1	44A410227-G01	Switch, Shield	Right Side of Shield
1	1	44A417036-001	Switch, Cover Interlock	Right Back, Bottom Cover
1	1	44A417037-001	Switch, Input Power	Right Back, Bottom Cover
1	3	44A417038-001	Switch, Toggle 2 Pos.	Front Control Panel
1	2	44A417039-001	Switch, Toggle 3 Pos.	Front Control Panel
1	7	44A417700-001	Switch, Pushbutton	Front Control Panel
1	1	44B417412-G01	LED PC Board	Front Control Panel, 2 Digit
1	1	44B417412-G02	LED PC Board	Front Control Panel, 3 Digit
2	1	44A417008-001	Bearing, Jack Shaft (Rt.)	Right Side Frame
2	1	44A410515-001	Bearing, Jack Shaft (Lf.)	Left Side Frame
2	4	44B417107-003	Bearing, Flanged	Left and Right Belt Pulley
1	1	44A410166-G02	Line Feed Relay	Inside Left Frame
1	1	44B417108-001	Line Feed Clutch	Left Side Jack Shaft
1	1	44A410246-G01	Ribbon Lift Asm.	Inside Right Frame
4	1	44A417013-002	Ribbon With Spools	
1	1	44D415570-G03	Ribbon Mech. Lf.	Left Outside of Frame
1	1	44D415571-G03	Ribbon Mech. Rt.	Right Outside of Frame
1	1	44A417024-001	Drive Belt, Lf.	Outside Left Frame
1	1	44A417024-002	Drive Belt, Rt.	Outside Right Frame
1	1	44B412576-001	Pulley, Jack Shaft (Rt.)	Outside Right Frame
1	1	44B412577-001	Pulley, Jack Shaft (Lf.)	Outside Left Frame
10	61	44A355938-001	Ferrite "U" Core	Senseline Driver
2	56	44A410016-G01	Ferrite Clip	Upper Keyboard
5	5	44A410376-G01	Ferrite Clip, Shimmed	Shift-RPT-CTL-ESC
1	1	44A410459-G01	Type 1 STD Font	Print Belt

5/2/72

<u>KIT</u> <u>QTY.</u>	<u>MACH.</u> <u>QTY.</u>	<u>PART NO.</u>	<u>DESCRIPTION</u>	<u>LOCATED</u>
1	0	44A410466-G03	Fuse Assortment	
1	0	A15B41H	Loctite	
1	0	44A410320-G02	Hardware Assort.	
1	0	44A410321-G01	Spring-Shim Assort.	
1	0	GEF-4359	Parts List	
5	7	7327	Lamp, Control Panel	Front Control Panel
1	0	44A417322-001	Carrying Case	
1	0	44B412269-001*	Pliers	
1	0	44A410619-G01*	Timing Gage	
1	0	44A410618-G01*	Plug, Test	
1	0	44A410368-G01*	Board Puller	
1	0	44A410583-001*	Pulley Alignment Tool	
1	0	44A410588-G01*	Bearing Puller	
1	0	44A417371-001	Belt Lube, MS122	6 oz. Aerosol Can
1	0	44A410695-G01	Graphite Solution	
1	1	44B417409-G01	P/S Converter (PSCC)	Bustle
1	1	44B417416-G01	Dataset (DATC)	Bustle
1	1	44B417405-G01	Answerback (ANSC)	Bustle
1	1	44B412157-G02	Horizontal Tab (HTBC)	Bustle
1	1	44B412163-G05	Reader and Punch (R&PC)	Bustle
1	1	44B412360-G01	Reader Board (RDR-B)	Console, Reader Drawer
1	1	44B412381-G01	Punch Board (PCH-B)	Console, Punch Drawer
1	1	44C414166-G08	Hammer Driver HDC	Under Frame, 118 Column
1	1	44B412343-G01	Desk Pwr. Supply Board	Console
1	0	44A410633-G01	Diode Jumper Kit	
1	1	44B412372-G03	Vertical Tab & Form Feed VT&FFC	Bustle, 11" Forms
1	1	44B417415-G01	Parity Error PARC	Bustle
1	0	44B412451-G01#	Cheater Cord	
1	0	44B412451-G02#	Cheater Cord	
2	1	12866	Reader Lamp	
		44A410710-G01*	Chad Removal Tool	

*Special Tools

#One of each required for B Machine

"C" MODEL SPARE PARTS KIT "RO"

PART NUMBER

44B412247-G14 Parts Kit

The following listed parts and special tools are available in kit form to provide service support on Model C RO units. These items are available as a kit or by individual purchase from the regular catalog.

<u>KIT</u> <u>QTY.</u>	<u>MACH.</u> <u>QTY.</u>	<u>PART NO.</u>	<u>DESCRIPTION</u>	<u>LOCATED</u>
1	1	44D415501-G01	Photocell Preamp (PC)	Under Lf. Side of Print Belt
1	1	44B412156-G02	S/P Converter (SPCC)	Bustle
1	1	44B412158-G03	Memory & Write Cont. (MEMC)	Bustle
1	1	44B412159-G03	Clock & Cycle Cont. (CLCC)	Bustle
1	1	44B412160-G04	Serial Decoder (DECC)	Bustle, 118 Column
1	1	44B412161-G02	Timing & Alarm (T&AC)	Bustle
1	1	44B412164-G02	S/V Protection (PROC)	Bustle
1	1	44B412165-G03	Lamp Regulator (LMPC)	Bustle
1	1	44B412166-G02	Photocell Amp (PCAC)	Bustle
1	1	44B417406-G01	H.V. Power Supply Bd. (TXPC)	Over Motor
1	1	44B412170-G04	L.V. Power Supply (POWC)	Bustle
1	1	44A410227-G01	Switch, Shield	Right Side of Shield
1	1	44A417036-001	Switch, Cover Interlock	Right Back, Bottom Cover
1	1	44A417037-001	Switch, Input Power	Right Back, Bottom Cover
1	1	44A417038-001	Switch, Toggle 2 Pos.	Front Control Panel
1	1	44A417039-001	Switch, Toggle 3 Pos.	Front Control Panel
1	6	44A417700-001	Switch, Pushbutton	Front Control Panel
2	1	44A417008-001	Bearing, Jack Shaft (Rt.)	Right Side Frame
2	1	44A410515-001	Bearing, Jack Shaft (Lf.)	Left Side Frame
2	4	44B232214-003	Bearing, Flanged	Left and Right Belt Pulley
1	1	44A410166-G02	Line Feed Relay	Inside Left Frame
1	1	44B417108-001	Line Feed Clutch	Left Side Jack Shaft
1	1	44A410246-G01	Ribbon Lift Asm.	Inside Right Frame
4	1	44A417013-002	Ribbon With Spools	
1	1	44D415570-G01	Ribbon Mech. Lf.	Left Outside of Frame
1	1	44D415571-G01	Ribbon Mech. Rt.	Right Outside of Frame
1	1	44A417024-001	Drive Belt, Lf.	Outside Left Frame
1	1	44A417024-002	Drive Belt, Rt.	Outside Right Frame
1	1	44B412321-001	Pulley, Jack Shaft (Rt.)	Outside Right Frame
1	1	44B412072-001	Pulley, Jack Shaft (Lf.)	Outside Left Frame
1	1	44B412205-G08	Type 1 STD Font	Print Belt
1	0	44A410466-G03	Fuse Assortment	
1	0	A15B41H	Loctite	
1	0	44A410320-G02	Hardware Assort.	
1	0	44A410321-G01	Spring-Shim Assort.	
1	0	GEF-4360	Parts List	
5	7	7327	Lamp, Control Panel	Front Control Panel
1	0	44A417322-001	Carrying Case	

<u>KIT</u> <u>QTY.</u>	<u>MACH.</u> <u>QTY.</u>	<u>PART NO.</u>	<u>DESCRIPTION</u>	<u>LOCATED</u>
1	0	44B412269-001*	Pliers	
1	0	44A410619-G01*	Timing Gage	
1	0	44A410368-G01*	Board Puller	
1	0	44A410583-001*	Pulley Alignment Tool	
1	0	44A410588-G01*	Bearing Puller	
1	0	44A417371-001	Belt Lube, MS122	6 oz. Aerosol Can
1	0	44A410695-G01	Graphite Solution	
1	1	44B417416-G01	Dataset (DATC)	Bustle
1	1	44B412157-G02	Horizontal Tab (HTBC)	Bustle
1	1	44C414166-G12	Hammer Driver (HDC)	Under Frame, 118 Column
1	0	44A410633-G01	Diode Jumper Kit	
1	1	44B412372-G03	Vertical Tab & Form Feed (VT&FFC)	Bustle, 11" Forms
1	1	44B417415-G01	Parity Error (PARC)	Bustle
1	0	44B412451-G01#	Cheater Cord	
1	0	44B412451-G02#	Cheater Cord	

*Special Tools

#One of each required for B Machine

DATA COMMUNICATION PRODUCTS DEPARTMENT
GENERAL ELECTRIC COMPANY, WAYNESBORO, VIRGINIA 22980

10-71 (750)

PRINTED
IN
U.S.A.

TermiNet^{*} 3000

DATA
COMMUNICATION
PRINTER

SPECIAL SHOP KIT FOR MODEL A AND B MACHINES

PART NUMBER

44B412247-G11 Parts Kit

The following listed parts and special tools are available in kit form to provide complete service support on Models A or B ASR and KSR units. These items are available as a kit or by individual purchase from the regular catalog.

<u>KIT</u> <u>QTY.</u>	<u>MACH.</u> <u>QTY.</u>	<u>PART NO.</u>	<u>DESCRIPTION</u>	<u>LOCATED</u>
1	1	44D415501-G01	Photocell Preamp (PC)	Under left side of Print Belt
1	1	44B412022-G01	Keyboard Sense-Line Driver	Inside Keyboard
1	1	44B412156-G01	S/P Converter (SPC)	Bustle
1	1	44B412158-G02	Memory & Write Control (MEM)	Bustle
1	1	44B412159-G01	Clock & Cycle Cont. (CLC)	Bustle
1	1	44B412160-G02	Serial Decoder (DEC)	Bustle
1	1	44B412161-G01	Timing & Alarm (T&A)	Bustle
1	1	44B412162-G01	Print Pos. Indicator (PPI)	Bustle
1	1	44B412164-G01	S/V Protection (PRO)	Bustle
1	1	44B412165-G01	Lamp Regulator (LMP)	Bustle
1	1	44B412166-G01	Photocell Amp (PCA)	Bustle
1	1	44B412168-G01	H.V. Power Supply Board (TXP)	Over Motor
1	1	44B412170-G03	L.V. Power Supply (POW)	Bustle
1	1	44A410227-G01	Switch, Shield	Right side of Shield
1	1	44A417036-001	Switch, Cover Interlock	Right back, Bottom Cover
1	1	44A417037-001	Switch, Input Power	Right back, Bottom Cover
1	3	44A417038-001	Switch, Toggle 2 Pos.	Front Cont. Panel
1	2	44A417039-001	Switch, Toggle 3 Pos.	Front Cont. Panel
1	7	44A417058-501	Switch, Pushbutton	Front Cont. Panel
2	3	44A417054-001	Digital Readout	Front Cont. Panel
2	1	44A417008-001	Bearing, Jack Shaft (Rt.)	Right Side Frame
2	1	44A410515-001	Bearing, Jack Shaft (Lf.)	Left Side Frame
2	4	44B232214-003	Bearing, Flanged	Left and Right Belt Pulley
1	1	44A410166-G02	Line Feed Relay	Inside Left Frame
1	1	44B417108-001	Line Feed Clutch	Left side Jack Shaft
1	1	44A410246-G01	Ribbon Lift Asm.	Inside Right Frame
4	1	44A417013-002	Ribbon with Spools	
1	1	44D415570-G01	Ribbon Mech. Lf.	Left outside of Frame
1	1	44D415571-G01	Ribbon Mech. Rt.	Right outside of Frame
1	1	44A417024-001	Drive Belt, Lf.	Outside left Frame
1	1	44A417024-002	Drive Belt, Rt.	Outside right Frame
1	1	44B412321-001	Pulley, Jack Shaft (Rt.)	Outside right Frame
1	1	44B412072-001	Pulley, Jack Shaft (Lf.)	Outside left Frame
10	61	44A355938-001	Ferrite "U" Core	Senseline Driver
2	56	44A410016-G01	Ferrite Clip	Upper Keyboard
5	5	44A410376-G01	Ferrite Clip, Shimmed	Shift-RPT-CTL-ESC
1	1	44B412205-G08	Type 1 STD Font	Print Belt
1	56	44A417044-003	Connector, Post	Right side Cont. Panel

*Registered Trademark of the General Electric Co., U.S.A.

<u>KIT</u> <u>QTY.</u>	<u>MACH.</u> <u>QTY.</u>	<u>PART NO.</u>	<u>DESCRIPTION</u>	<u>LOCATED</u>
2	8	44A417044-002	Connector (Insulator)	Right side Cont. Panel
1	0	44A410466-G02	Fuse Assortment	
1	0	A15B41H	Loctite	
1	0	44A410320-G01	Hardware Assort.	
1	0	44A410321-G01	Spring-Shim Assort.	
1	0	GEF-4358	Parts List	
1	1	44B412169-G03	Keyboard Interface (KIF)	Bustle
5	7	327	Lamp, Control Panel	Front Cont. Panel
1	1	44A410166-G01	Line Feed Relay	Inside Lf. Frame
1	1	44C414046-G01	Clutch Assy.	Left Side of Jackshaft
1	0	44A317422-G01	Carrying Case	
1	0	44B412269-001*	Pliers	
1	0	44A410619-G01*	Timing Gage	
1	0	44A410618-G01*	Plug, Test	
1	0	44A410368-G01*	Board Puller	
1	0	44A410583-001*	Pulley Alignment Tool	
1	0	44A410588-G01*	Bearing Puller	
1	1	44B412154-G01	P/S Converter (PSC1)	Bustle
1	1	44B412428-G01	Dataset (DATB)	Bustle
1	1	44B412153-G01	Answerback (ANS)	Bustle
1	1	44B412157-G01	Horizontal Tab (HTB)	Bustle
1	1	44B412163-G01	Reader and Punch (R&P)	Bustle
1	1	44B412360-G01	Reader Board (RDR-B)	Console, Reader Drawer
1	1	44B412381-G01	Punch Board (PCH-B)	Console, Punch Drawer
1	1	44C414064-G03	Hammer Decoder Board	Under Frame
1	1	44C414063-G01	Hammer Decoder Access. Board	Under Frame
1	1	44B412343-G01	Desk Pwr. Supply Board	Console
1	0	44A410633-G01	Diode Jumper Kit	
1	1	44A410173-G01	Spring Assembly, Backlash	Left Side Frame

* Special Tools