

# DIGITAL EQUIPMENT CORPORATION

NINETEEN FIFTY-SEVEN  
TO THE PRESENT

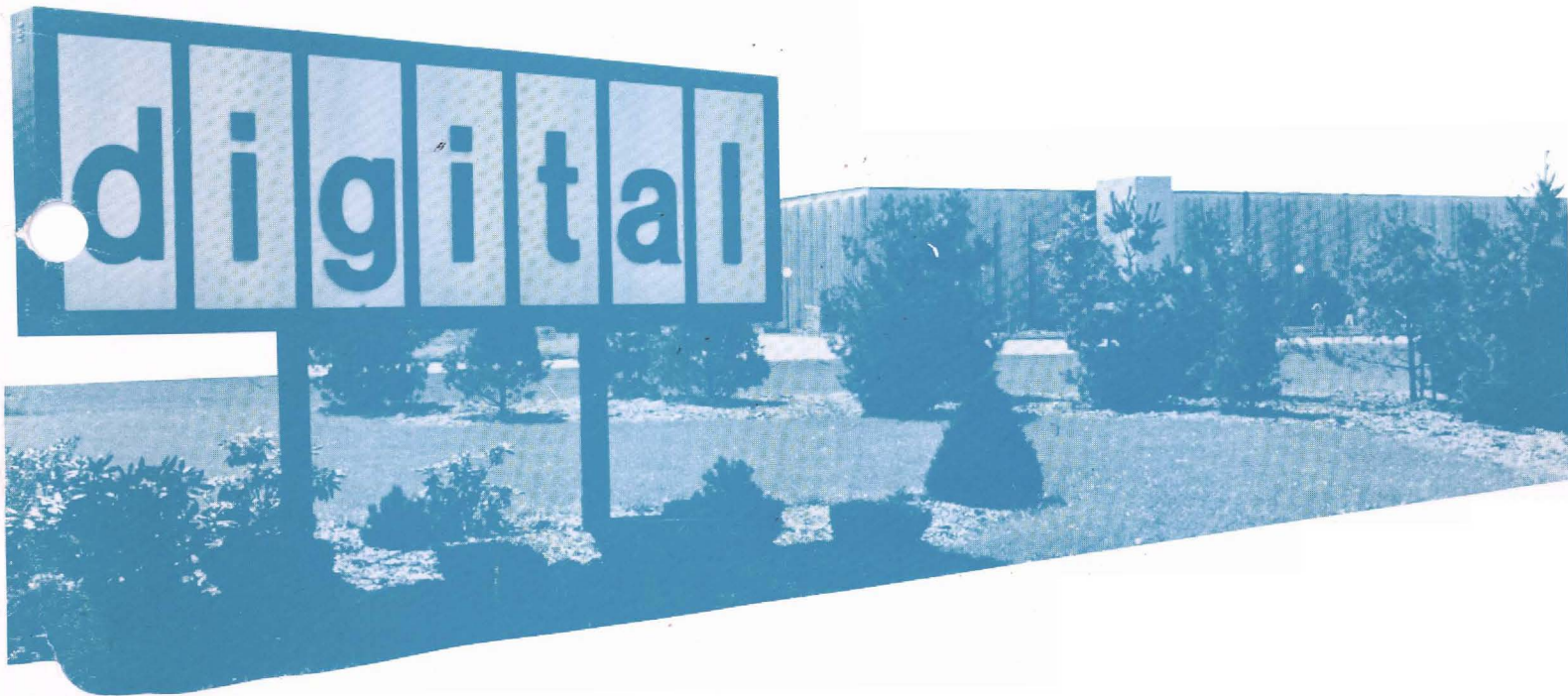

# **DIGITAL EQUIPMENT CORPORATION**

**NINETEEN FIFTY-SEVEN  
TO THE PRESENT**



# TABLE OF CONTENTS

<b>SECTION</b>	<b>PAGE</b>	<b>SECTION</b>	<b>PAGE</b>
INTRODUCTION	vii	<b>1970</b>	
<b>1957-1963</b>		MUMPS	17
MAYNARD MILL	2	TABS-8	17
DECUS	2	FINANCIAL SUMMARY	17
MODULES	2	<b>1971</b>	
MEMORY TEST	3	MILESTONES	20
PDP-1	3	GALWAY	20
PDP-2 & 3	3	DIGITAL PARK	20
PDP-4	3	PDP-11/15	20
PDP-5	4	PDP-8/M	20
FINANCIAL SUMMARY	4	PDP-11/05	21
<b>1964-1967</b>		VT05	21
FIRST PRODUCT LINE	6	LA30	21
PDP-6	6	TU10	21
PDP-7, PDP-7A	6	PDP-11/45	22
FIRST MINICOMPUTER	6	PDP-16 (RTMS)	22
PDP-8	7	FINANCIAL SUMMARY	22
PDP-8/S	7	<b>1972</b>	
PDP-9, 9L	7	TAIWAN	24
LINC-8	8	PDP-16/M	24
PDP-10	8	PDP-8/F	24
FINANCIAL SUMMARY	8	DCM-11	24
<b>1968-1969</b>		LAB-11	25
K SERIES MODULES	10	IDACS-11	25
PDP-8/I, 8/L	10	PHA-11	25
PDP-12	11	RSTS-11	25
PDP-14	11	TYPESET-10	26
PDP-15	11	DDS-300	26
EDUSYSTEMS	12	DDS-520	26
TSS-8	12	TYPESET-11	26
QUICKPOINT-8	12	DECSYSTEM-10	27
TYPESET-8	12	FINANCIAL SUMMARY	27
LAB-8	13	<b>1973</b>	
PHA-8	13	PDP-11/10	30
COMPUTERPAKS	13	PDP-11/40	30
IDACS-8	13	LPS-11	30
RAD-8	14	GT40	31
CLINICAL LAB-12	14	CAPS-8	31
FINANCIAL SUMMARY	14	RSX-11D	31
<b>1970</b>		CAPS-11	32
TWO MANUFACTURING FACILITIES	16	UNICHANNEL-15	32
PDP-8/E	16	PDP-15/76	32
PDP-11/20	16	RK-15	33
		GRAPHIC-76	33

<b>SECTION</b>	<b>PAGE</b>	<b>SECTION</b>	<b>PAGE</b>
<b>1973</b>		<b>1975</b>	
FINANCIAL SUMMARY	33	PDP-11/04	49
<b>1974</b>		TU45	49
MARKET GROUP REORIENTATION	36	LSI-11	49
SOFTWARE PRODUCT LICENSING	36	PDP-11/70	50
NATIONAL ACCOUNTS PROGRAM	36	DV11	50
RIMS	36	ICS, ICR	50
MARLBOROUGH	37	TS03	51
DIGITAL PARK	37	RX01	51
COMPONENTS GROUP	37	PDP-11/03	51
PDP-14/30, /35	37	VT55	51
PDM70	38	RTS-8	52
PROM-8M	38	IAS	52
MICROPROCESSOR SERIES	38	FORTRAN IV-PLUS	52
RJS03/04	39	PDP-11 COBOL	52
PDP-8/A MINIPROCESSOR	39	DECNET	53
8/A MODULE KIT	39	DECCOM 600	53
8/A OEM PACKAGE	39	DATASYSTEM 535	53
TU16	40	PDP-8/A BASED SYSTEMS	54
RT-11	40	DEC DATASYSTEM 310	54
RSX-11M	40	CMS/1	54
RSX PLUS III	41	CLASSIC	54
STANDARD SYSTEMS	41	PDL	55
LAB-11E10	41	XVM SYSTEMS	55
IND 1150	41	INDUSTRIAL 850 & 840 SERIES	55
IND 8/C	41	FINANCIAL SUMMARY	56
DDS-500	42	<b>1976</b>	
GT44	42	MILESTONES	58
DECSET-8000	42	4K BIPOLAR PARITY MEMORY (MS11-AP) FOR THE PDP-11/45-11/50	58
GT42	42	11T40	58
DATA COMMUNICATIONS PACKAGES	43	THE PDP-8/A-800 SERIES	58
DDS-340	43	LA180	59
EDUSYSTEMS 100, 200, 250	43	VT55 HARD COPY UNIT	59
DECLAB	43	VT52	59
FINANCIAL SUMMARY	44	RK05J	59
<b>1975</b>		MPS PROGRAM	60
TELCO	46	11V03	60
MILESTONE	46	NEW LA35 AND LA36	60
RP04	46	DMC11 NETWORK LINK	61
LA36	47	DUP11	61
AR11	47	FPP-11C FLOATING POINT UNIT FOR THE 11/70	61
VT-11	47	PDP-11F10	61
VT50 DECSCOPE	48	TU45 TAPE SYSTEM	61
KL-10	48	11T55	62
TU70	48		
8/A 200, 400	48		

**SECTION****PAGE****SECTION****PAGE****1976**

THE PDP-8/A 600 SERIES	62
PDP-11F34	62
GT43	62
RP05 AND RP06 DISK DRIVES	63
THE VT71/T TERMINAL	63
RK05F DISK DRIVE	63
RSX-11M/2780	64
FORTRAN/RSTS-E	64
NEW VERSION OF EDUSYSTEM 20, 25	64
EDUSYSTEM 50 (TSS/8)	64
FOCAL UNDER RT-11	64
ASSIST-11 DIRECTORY ASSISTANCE SYSTEM	64
COS 310/2780 EMULATION FOR DS310	64
RT-11/2780	64
PDL/RT-11	64
CPL FOR DECSYSTEM-10 AND DECSYSTEM-20	64
REMOTE-11	65
CTS-500/E DATA MANAGEMENT SERVICES 500	65
FOCAL/MPS	65
PDP-15/XVM	65
BASIC-11 IAS/RSX VERSION 2.0	65
RPG II	65
INDUSTRIAL BASIC/RT-11	65
IAS V1.1	65
RMS-11/DBMS-11	65
DATASYSTEM 350 SERIES OF SMALL BUSINESS TIME SHARING SYSTEMS	66
11T35	66
POWER MANAGEMENT SYSTEMS	66
VS60, GT62	67
THE SYSTEM 800	67
DEC DATASYSTEM 535-E	67
MU/11V03	67
GT-46	68
PDP-11/34 SYSTEMS	68
PDP-11 FORTRAN SYSTEMS	68
DECEDIT	69
DECSYSTEM-20	69
DS350 11/34 PACKAGED SYSTEMS	69
DATASYSTEM 534 PACKAGED SYSTEMS	69
DEC DATASYSTEM 530	70
DECSYSTEM 1088 AND DECSYSTEM DUAL 1080	70

**1976**

DEC DATASYSTEM 570	70
WORD PROCESSING 310W	70
FINANCIAL SUMMARY	71

**1977**

MILESTONES	74
THE GRAPHIC SYSTEMS GROUP	74
PDP-8 PRODUCT LINE	74
50,000TH LA36	74
GOVERNMENT INFORMATION SYSTEMS	74
1000TH 11/70 DELIVERED	74
LARGE COMPUTER GROUP REORGANIZES INTO INDEPENDENT MARKET-ORIENTED PRODUCT LINES	74
VT61 AND VT61T	74
PDP-11S34	74
RK06	75
PDP-11S55	75
PDP-1134A	75
LP14	75
LS120 DECWRITER III	76
PAPERTAPE READER FOR THE LA36	76
RSTS/E V6B	76
CTS-500	76
PEAK-11	76
CTS-300 DICAM	76
APL-11	77
DBMS-11	77
DX/RSTS	77
DATASYSTEM 357	77
D537	77
THE WORD SYSTEM 102	77
DECLAB 11/03 AND DECLAB 11/34	78
THE DATASYSTEM 320	78
DECSYSTEM-2050	79
DPM SYSTEMS	79
PDP-11/60	79
DECSTATION	79
FINANCIAL SUMMARY	80

**DIGITAL'S MANUFACTURING CAPABILITY** 81**SYSTEM, OPERATING REVENUES AND PRODUCT SUMMARIES** 85

Copyright © 1972, 1973, 1974, 1975, 1976, 1978  
DIGITAL EQUIPMENT CORPORATION  
MAYNARD, MASSACHUSETTS



*Thompson St. --- Assebet Mills.*

*1881*

## INTRODUCTION

Digital Equipment Corporation is proud of its history. In a relatively short period of time, DIGITAL has grown into the leading manufacturer of minicomputers. However, our growth in size and volume has not diminished our feeling of responsibility to furnish our customers with the highest quality products and service that we can provide.

It is fitting that DIGITAL had its beginnings in an old New England mill. The mills of this region have always stood as examples of New England's traditional values: the work ethic, Yankee ingenuity, care in craftsmanship, and pride in good work. However, these values alone are not sufficient to sustain a successful business. DIGITAL has incorporated these traditional values and successfully added innovative and dynamic approaches to the computer field.

This document does not assume to be a total history of Digital Equipment Corporation, for DIGITAL's history is not yet complete. We are constantly creating new ways in which our products, services, and computers may serve and fulfill the needs of our customers.





GENERAL  
MAYNARD MILL  
DECUS

HARDWARE  
MODULES  
MEMORY TEST  
PDP-1  
PDP-2, PDP-3  
PDP-4  
PDP-5

FINANCIAL SUMMARY



1957-1963

## GENERAL

1957

Nineteen seventy-seven marked the 20th anniversary of the founding of Digital Equipment Corporation. On August 23, 1957, three men, Ken Olsen, his brother Stan Olsen, and Harland Anderson began DIGITAL with \$70,000 of capital, 8,500 square feet of rented space, and a single product—logic modules.

Today, DIGITAL has more than 90,000 computer systems in operation, is the largest manufacturer of interactive minicomputers, and is a billion dollar-a-year company. DIGITAL is the sole owner and occupant of the sprawling 21-building Maynard Mill complex and has expanded operations to an additional 300 sites throughout the world.



### MAYNARD MILL

They first rented 8,500 sq. ft. of space, now Building 12, in the Maynard Mill complex. The company was set up with funding from American Research and Development, a Boston-based, venture capital firm, AR&D bought 70% of the company for a \$70,000 initial investment.

In early 1957, Ken Olsen, Stan Olsen, and Harland Anderson left M.I.T.'s Lincoln Labs, where Ken had worked with some of the first transistorized computers, the TX0 and the TX2, machines that were also revolutionary in having core memories. Although many manufacturers already existed in the field, none had a firm control of the market. The three men decided to set up a company primarily to sell electronic modules for fast (5 megacycles) applications, applying the solid state techniques they had learned.

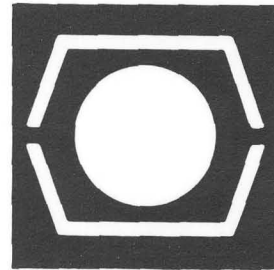

1961

### DECUS

DECUS, the Digital Equipment Computers Users Society, was founded for users of DEC computers and modules. This group has grown to become the largest single computer users society in the world.

## HARDWARE

1958

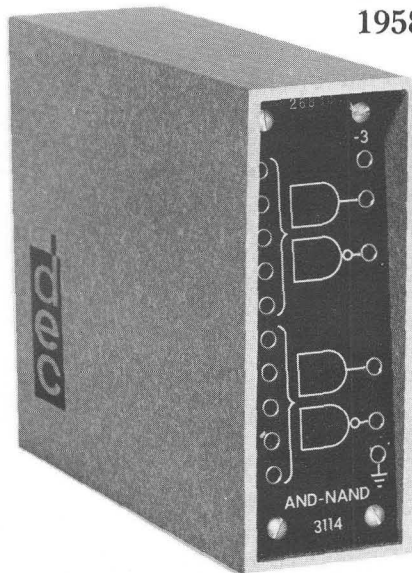

### MODULES

The initial applications of DIGITAL's modules were in testing (memory systems, etc.) and other laboratory automation operations.

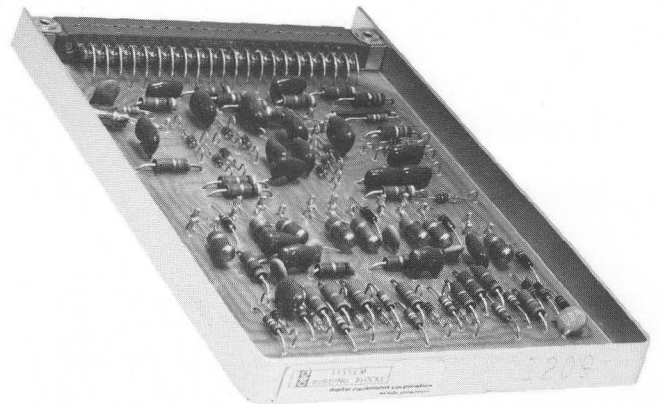

A second range of modules which allowed more components on each board was announced. These "system modules" were actively sold until 1966 and in various forms were the basis of five subsequent computer systems.

1959

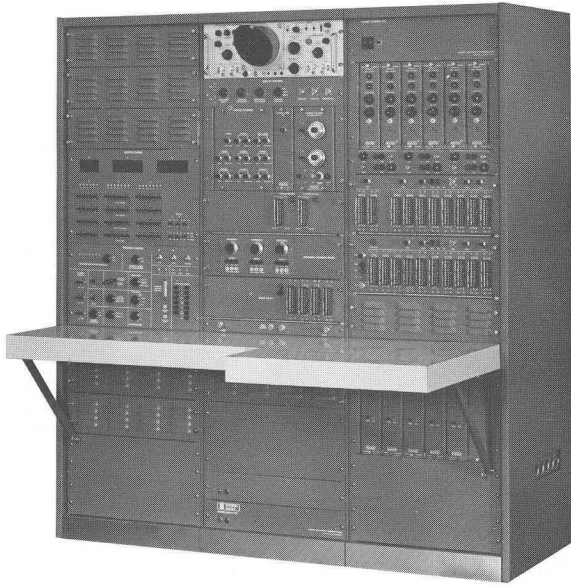

### MEMORY TEST

Early in the year, the company designed a system for use in the memory test area. Around 50 memory testers were sold in the eight years DIGITAL remained in the market.

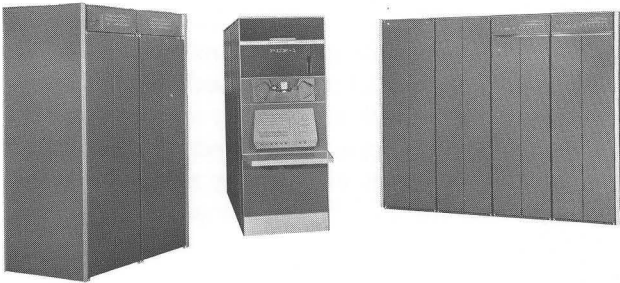

### PDP-1

Around this time, the company's first Programmed Data Processor, the PDP-1 computer, was being designed. It used DIGITAL's own system modules, which came from the existing range of 10MC logic released in late 1959. The first PDP-1, delivered in December, was a high speed, 18-bit, small computer capable of addressing 32K of core memory. An average configuration cost \$120,000 in an era when most computer systems were sold for a million dollars or more.

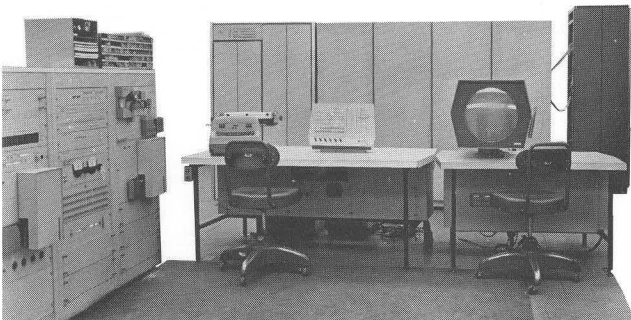

Some of the first PDP-1's had graphic display systems as peripherals. These were the first commercially available graphic terminals for computers. Although the last PDP-1 was built in 1969, nearly all 53 PDP-1's are still in use, most of them in universities. Some of the applications of this machine included message switching, instrument control, and special purpose timesharing.

### PDP-2 AND PDP-3

Two new products, the PDP-2 and PDP-3, were proposed while the PDP-1 was in production. The PDP-2 never progressed beyond the initial stages. The PDP-3, a 36-bit computer based on PDP-1 concepts, was designed but not built by the company.

1962



### PDP-4

The PDP-4, first delivered this year, began a development tradition. Although similar in structure (18 bits but slightly different architecture) to its predecessor, the PDP-1, it was considerably less expensive. The use of slower memory and different packaging allowed the company to reduce the price to \$65K.

Approximately 54 PDP-4's were sold in application areas as diverse as nuclear physics, production, and stock control.

**PDP-5**

The PDP-5, DIGITAL's first 12-bit computer and the world's first commercially produced minicomputer, was designed for a market that required much less computing power than was presently provided by machines like the PDP-4, but that had applications needing solutions too complicated to be solved efficiently by modules systems. The success of the PDP-5, forerunner of the PDP-8, proved that a market for minicomputers did exist.

---

**FINANCIAL SUMMARY**

<b>FISCAL YEARS</b>	<b>1962</b>	<b>1963</b>
Total Operating Revenues	\$ 6,535,502	\$ 9,906,968
Income Before Income Taxes	1,667,180	2,399,104
U.S. & Foreign Income Taxes	860,000	1,218,907
Net Income	807,180	1,180,197
Total Assets	4,177,363	4,835,580
Current Assets	3,845,375	4,248,646
Current Liabilities	2,598,247	1,803,866
Stockholders Equity	1,492,241	2,661,089
No. of Shares Outstanding at Year End	22,162,500	22,792,500
Net Income Per Share	\$.04	\$.05

GENERAL  
FIRST PRODUCT LINE

HARDWARE

- PDP-6
- PDP-7, PDP-7A
- FIRST MINICOMPUTER
- PDP-8
- PDP-8S
- PDP-9, 9/L
- LINC-8
- PDP-10

FINANCIAL SUMMARY

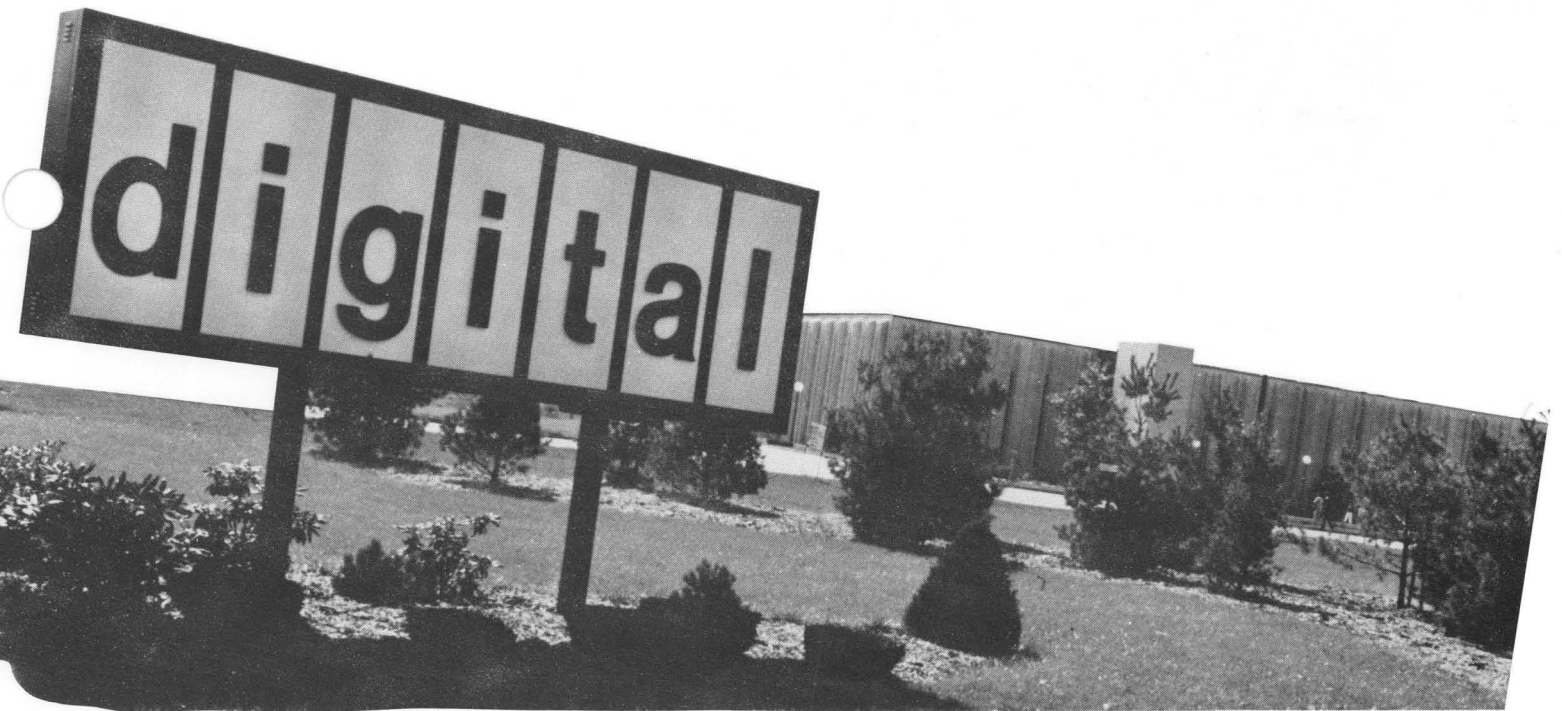

1964-1967

## GENERAL

1964

### FIRST PRODUCT LINE

The first Product Line at DIGITAL was formed during this year, an event that marked an upswing in DIGITAL's sales volume and profits. This approach teamed the Engineering, Programming, Marketing, and Production de-

partments under a Product Line Manager who had profit and loss responsibility. The concept soon spread from the PDP-6 group to embrace the entire company by the following year.

## HARDWARE

1964

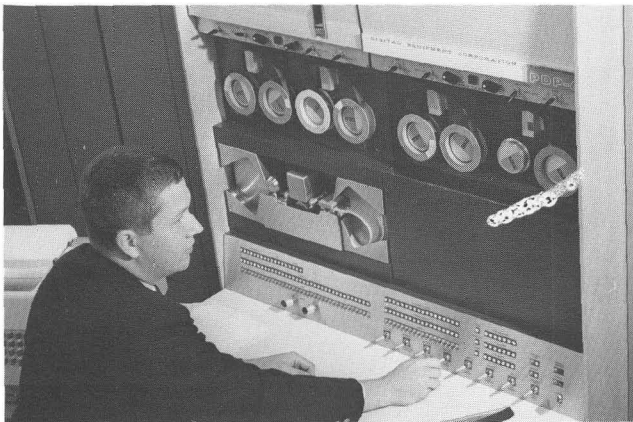

### PDP-6

The 36-bit PDP-6, DIGITAL's first large computer, was released late this year. It was the first commercially available computer with manufacturer-provided software for general purpose timesharing applications. Other timesharing systems, such as the PDP-1 and Project MAC at

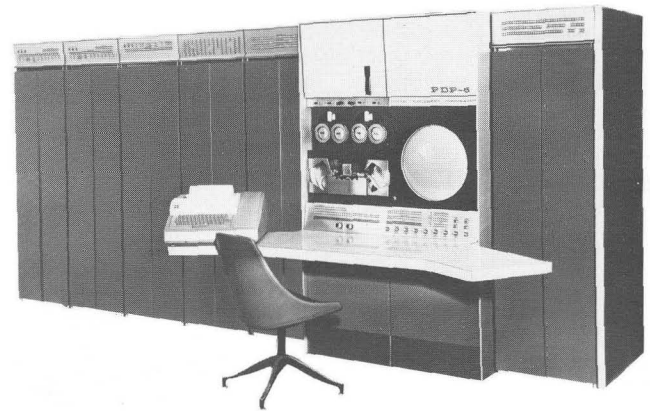

M.I.T., were previously available, but none had manufacturer support. Some new techniques, including larger system units, were used in the twenty-three PDP-6 systems installed.

1965

### FIRST MINICOMPUTER

The highlight of 1965 was the introduction of the first production model "minicomputer" (small in physical size; word-length under 16 bits; selling in minimum configuration for under \$20K).



### PDP-7, PDP-7A

The PDP-7 was added to the range of 18-bit computers. This successor to the PDP-4, using the smaller, more conventional system units, was well received in laboratory and data acquisition applications.

A second version of this machine, known as the PDP-7A, was built about a year later using R Series modules.

One hundred-twenty PDP-7's were sold all together.



### PDP-8

This computer was the PDP-8, or classic 8, which used the newly announced R Series logic, and of which more systems in a variety of configurations and for innumerable applications have been sold than any other DIGITAL product.

Just prior to the 8's announcement, both major competitors had introduced competitive machines based on the price and performance of the PDP-5, giving the PDP-8 a two-year edge in the marketplace.



### 1966



### PDP-8/S

Following upon the success of the PDP-8, a serial version, called the 8/S, was developed. This design took only nine months from inception to production, underlining DIGITAL's record of production engineering. The PDP-8/S was the first computer with 4K of memory sold for under \$10,000.



### PDP-9, PDP-9/L

Also during this year, the PDP-9 was added to DIGITAL's line of 18-bit computers, featuring a speed increase of approximately twice that of the PDP-7. The PDP-9 was also one of the first small or medium scale computers to have a keyboard monitor system based on DIGITAL's own small magnetic tape units (DECTape).

A compact version of the PDP-9, called the PDP-9/L, was released later, selling an additional 40 units.

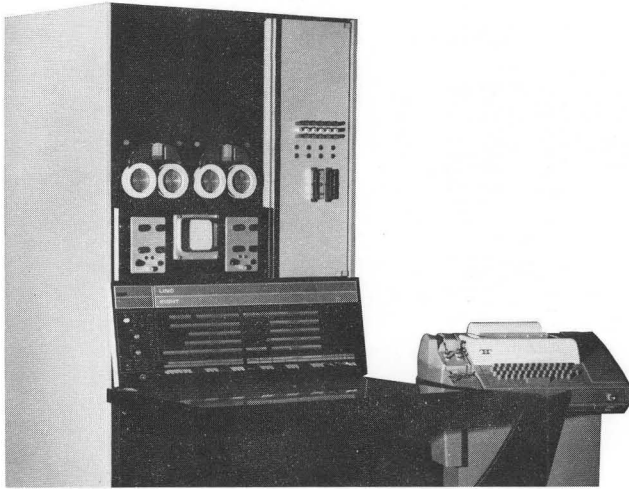

**LINC-8**

Finally that year, the LINC-8 was built, based on a previous design from the Lincoln Labs to penetrate the emerging biomedical computer market. This computer incorporated both the LINC (Laboratory Instrument Computer) processor and well-established PDP-8 processor unit.

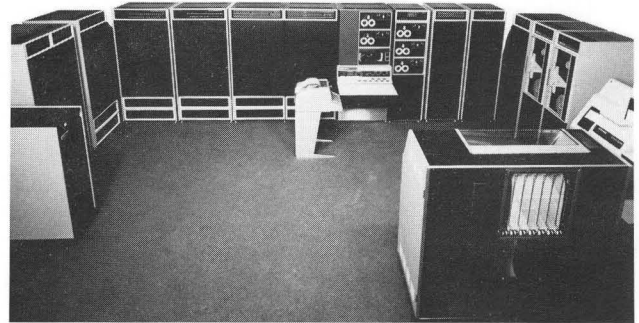
**PDP-10**

During this year, a successor to the PDP-6 was announced. The 36-bit PDP-10 computer was program-compatible with the PDP-6 and approximately twice as powerful. Designed to perform conversational time-sharing, batch-processing, and real-time operations equally well and simultaneously, the PDP-10 achieved great popularity with the commercial time-sharing utilities, university computer centers, and research laboratories.

**FINANCIAL SUMMARY**

<b>FISCAL YEARS</b>	<b>1964</b>	<b>1965</b>	<b>1966</b>	<b>1967</b>
Total Operating Revenues	\$10,909,565	\$14,982,920	\$22,776,434	\$38,895,782
Income Before Income Taxes	1,780,629	1,387,025	3,500,662	8,319,760
U.S. & Foreign Income Taxes	878,015	646,140	1,550,122	3,778,555
Net Income	902,614	740,885	1,950,540	4,541,205
Total Assets	5,708,173	10,775,990	15,111,228	21,733,105
Current Assets	4,999,711	9,660,318	13,391,341	19,970,723
Current Liabilities	1,796,346	6,371,978	8,725,926	6,016,348
Stockholders Equity	3,557,452	4,365,887	6,363,427	15,707,382
No. of Shares Outstanding at Year End	22,995,000	23,220,000	24,075,000	26,190,000
Net Income Per Share	\$.04	\$.03	\$.08	\$.18

**HARDWARE**  
K SERIES MODULES  
PDP-8/I, PDP-8/L  
PDP-12  
PDP-14  
PDP-15

**SYSTEMS**  
EDUSYSTEMS  
TSS-8  
QUICKPOINT-8  
TYPESET-8  
LAB-8  
PHA-8  
COMPUTERPAKS  
IDACS-8  
RAD-8  
CLINICAL LAB-12

**FINANCIAL SUMMARY**



**1968-1969**

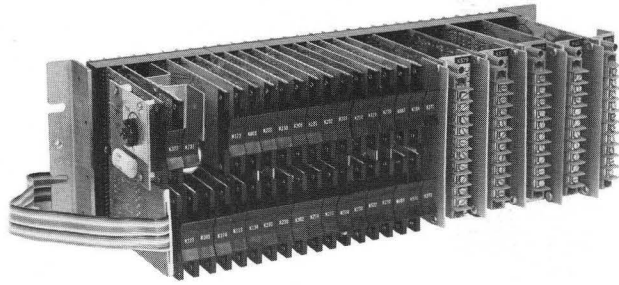

**K SERIES MODULES**

A new line of highly noise-immune K Series modules had been introduced in mid-1967. By early 1968 the success of the K Series modules was well established. Today there are approximately 200 different K Series modules, which are used for control applications in industrial computers.

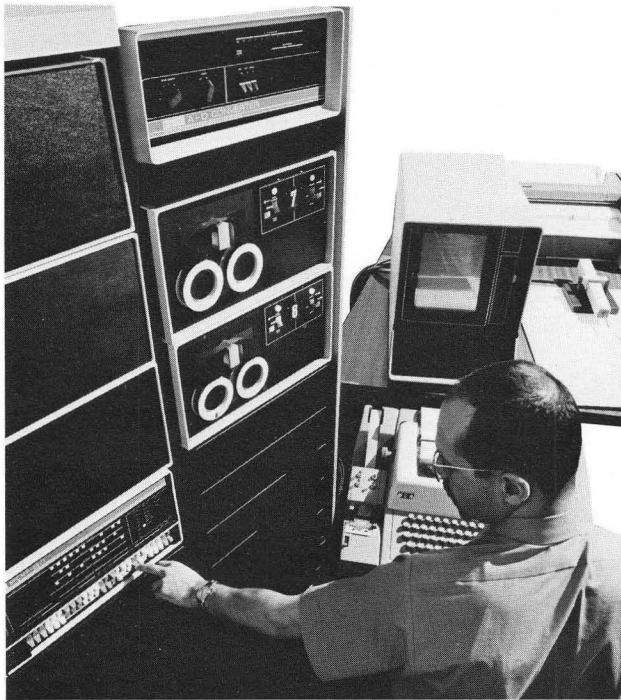

**PDP-8/I, PDP-8/L**

In another burst of product development, two best-selling successors to the PDP-8, the PDP-8/I and PDP-8/L, were released.

The 8/I was more expandable (and expensive) than the PDP-8/S. The 8/L was a smaller OEM version of the 8/I. Both machines operated at the same speed as their predecessor.

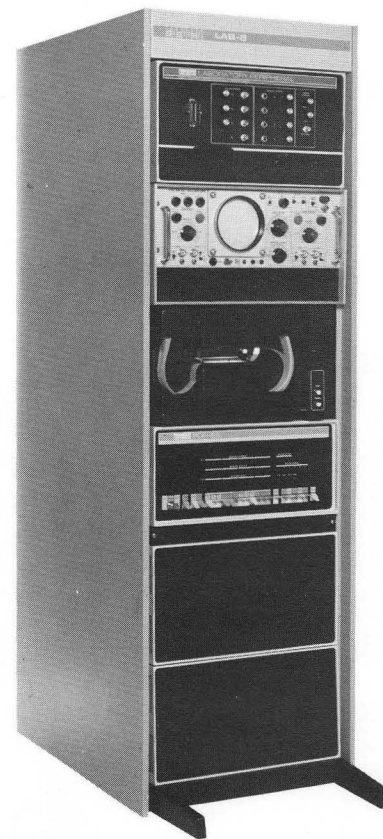

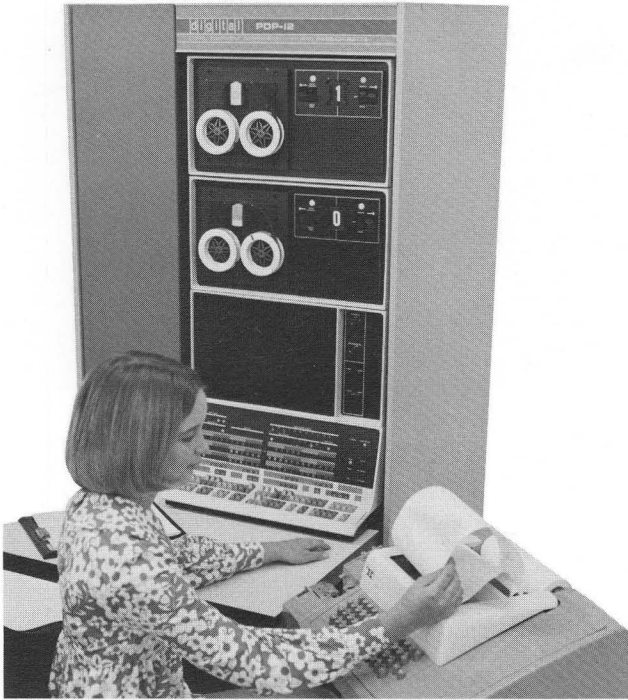

### PDP-12

The PDP-12, successor to the LINC-8, was released for use in applications such as chemistry, applied psychology, patient monitoring, and industrial testing. In less than a year, four hundred orders had been placed for the PDP-12, which incorporated the PDP-8/I and LINC-8 instruction sets, making it compatible with LINC-8 software. In addition to a display-based operating system, software packages were included for data acquisition and display, Fourier analysis, and mass spectrometry.

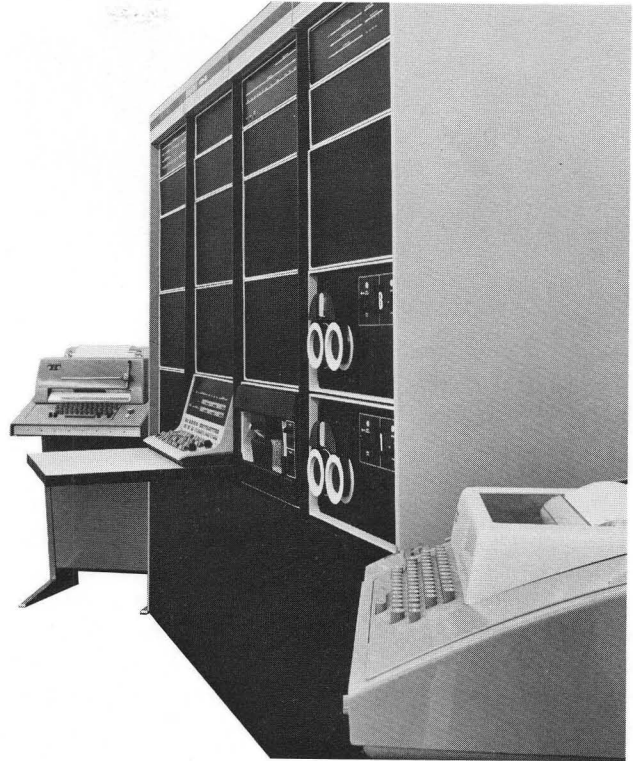

### PDP-15

The next announcement this year was the long-awaited successor to the PDP-9 and 9/L. The PDP-15, faster and less expensive than its predecessors, had the added sophistication of separate I/O processor to the CPU. Over 400 of these new 18-bit machines were ordered in the first eight months. The PDP-15 found great acceptance in both the established physics and communications markets as it added new markets such as computer-aided graphics with the GRAPHICS-15, and large real-time operations with RSX-15, a sophisticated monitor system. An average PDP-15 configuration cost \$90-120,000, compared to \$50,000 for the PDP-9.



### PDP-14

The PDP-14 was delivered in March. K Series modules were used to develop noise-immune I/O units for this completely new, solid state controller that controlled operations by solving Boolean equations. Applications in the relay-logic marketplace included an automatic racking and stacking system, control of machine tools, and sequencing. The PDP-14/L, with reduced I/O capabilities and a lower cost, was added to the product line during the following year.



**EDUSYSTEMS**

Computers began coming into wide use in colleges around this time. PDP-8-based EDUsystems using the BASIC® language (developed by Dartmouth College) went a step further by bringing computers into secondary and elementary schools. Because EDUsystems start small and expand, a school could start with EDUsystem-05 and work up to EDUsystem-50 as its computing requirements increase.

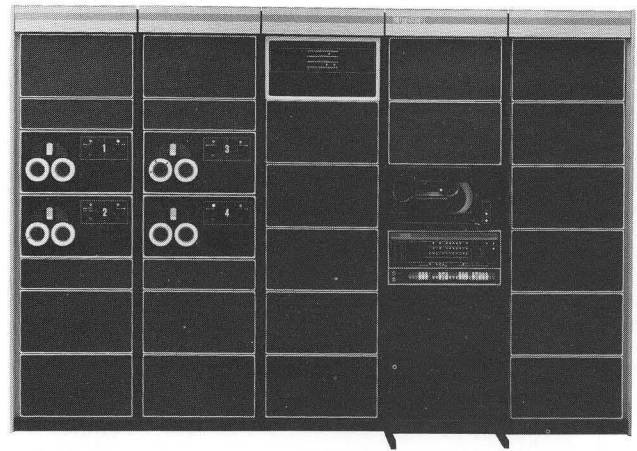
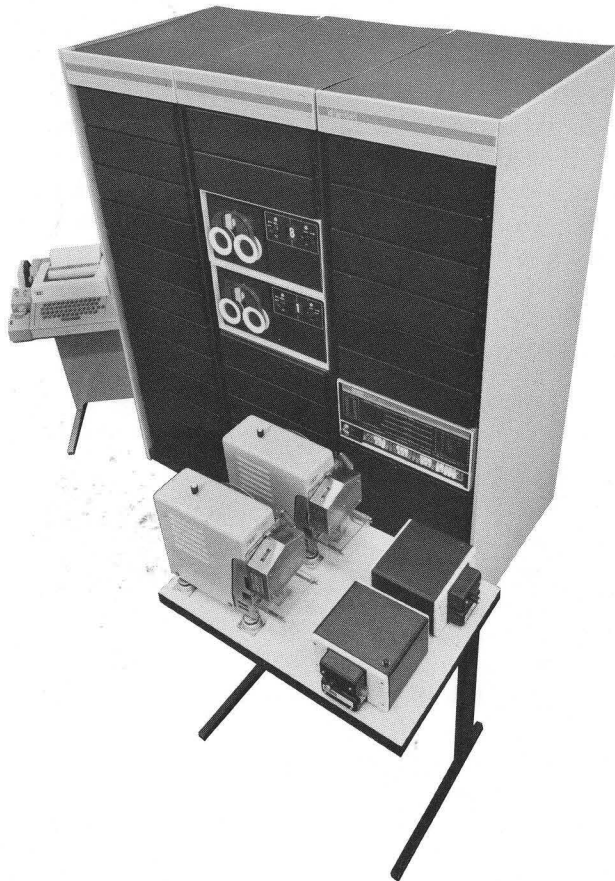

**TSS-8**

The TSS-8 timesharing system was also developed on the PDP-8, although most systems were shipped with the newer PDP-8/I processor. This system, a multilingual, local timesharing system offering simultaneous use to as many as 32 users, supported both high-level and machine languages.

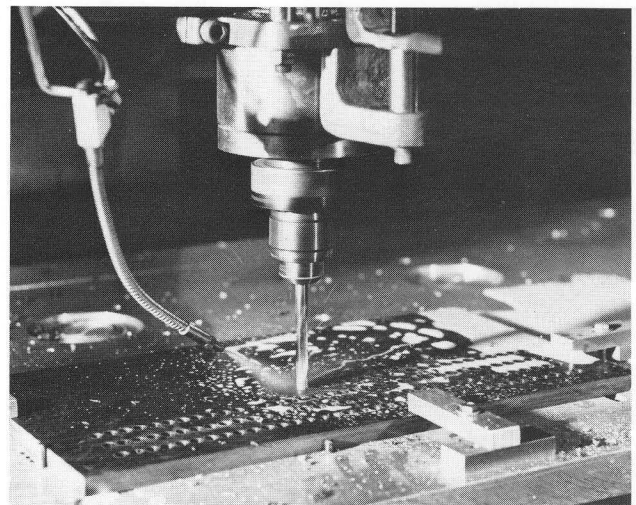

**QUICKPOINT-8**

QUICKPOINT-8 prepares tapes for numerically-controlled, point-to-point tools.

**TYPESET-8**

The pioneer of the "turn key" computer system was the TYPESET-8. This hardware and software package, originally sold with the classic PDP-8 as its CPU, later used the 8/I, 8/L and 8/E. The computerized typesetting system takes unjustified and unhyphenated type for use with hot metal and photo composition machines.

Two system packs were developed for laboratory applications—the LAB-8 and PHA-8.



#### LAB-8

The LAB-8 is a small, general purpose lab package that enables any PDP-8 to signal, calculate, and display the trend and variance of data, display blow-ups of areas of interest, and control the experiment.

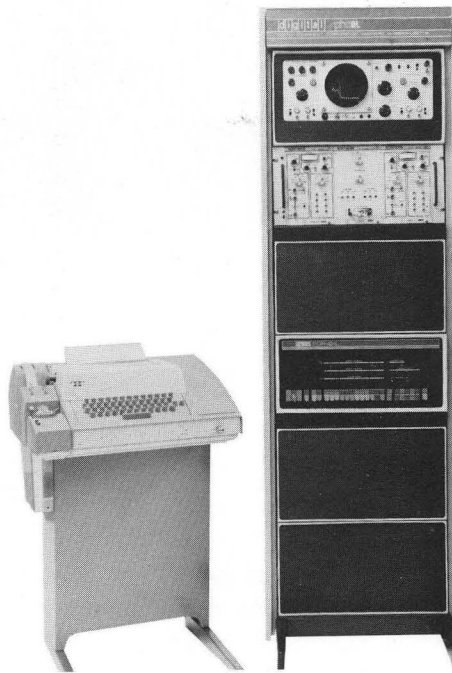

#### PHA-8

PHA-8, the first in a series of complete computer systems developed for pulse height analysis, gathers, stores, displays, and analyzes energy of time-of-flight spectra and records the results on a variety of output devices. The PDP-8 family have proven to be excellent tools for the industrial lab, manufacturing plant, or physics class.

#### COMPUTERPAKS

During 1968-1969, a number of computer system packages, called *COMPUTERPAKS*, were developed based upon *DIGITAL's* highly successful PDP-8 computers. Special software was designed to handle a variety of applications.

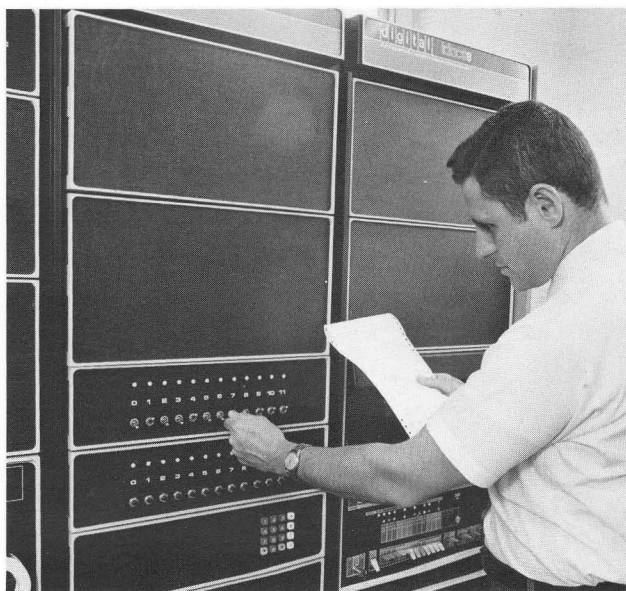

#### IDACS-8

IDACS-8, a computerized, real-time industrial applications package, incorporated a special task-oriented language, *INDAC*, with data acquisition and control hardware. The *SNAP* feature allows the user to get a "snapshot" of the entire system, or any part of it, at any time. IDACS-8 is presently in use in hundreds of industrial control and data acquisition applications.

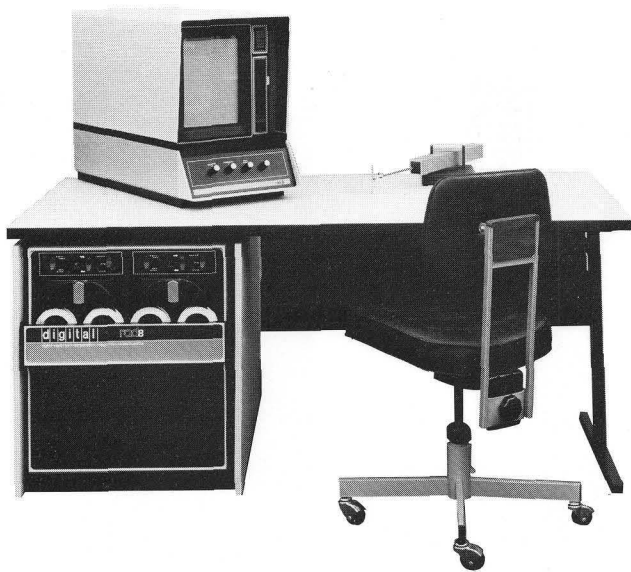

### **RAD-8**

RAD-8, another PDP-8 based system, was developed by the Medical Systems Group for radiation treatment planning. In addition to calculating radiation doses, RAD-8 can be used for other therapy functions, patient record keeping, and accounting.

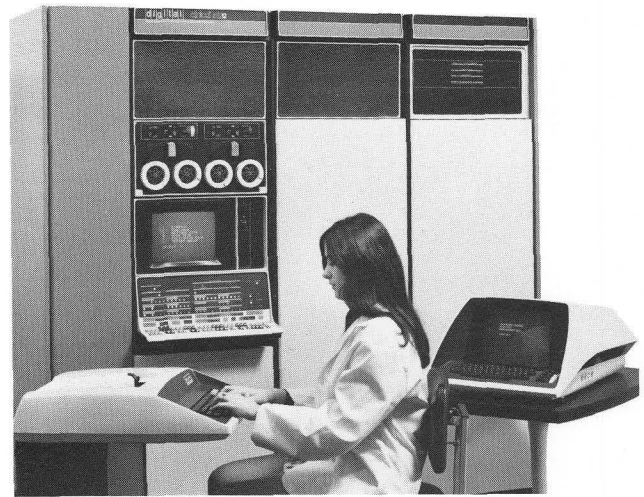

### **CLINICAL LAB-12**

A PDP-12 COMPUTERPACK provided the basis for a laboratory information system, the CLINICAL LAB-12. This system was used to automate the clinical laboratory to analyze data from instruments and incorporate the results into various reports for the patient's physician.

## **FINANCIAL SUMMARY**

<b>FISCAL YEARS</b>	<b>1968</b>	<b>1969</b>
Total Operating Revenues	\$57,339,400	\$91,244,000
Income Before Income Taxes	12,934,690	17,300,000
U.S. & Foreign Income Taxes	6,078,000	7,900,000
Net Income	6,856,690	9,400,000
Total Assets	36,496,876	62,304,000
Current Assets	33,562,457	55,081,000
Current Liabilities	13,806,354	16,915,000
Stockholders Equity	22,690,522	45,389,000
No. of Shares Outstanding at Year End	26,339,400	27,647,913
Net Income Per Share	\$.26	\$.35
EMPLOYEES AT YEAR END	2,600	4,360
SHAREHOLDERS AT YEAR END	595	3,586

GENERAL  
TWO NEW MANUFACTURING  
FACILITIES  
WESTFIELD  
WESTMINSTER

HARDWARE  
PDP-8/E  
PDP-11/20

SOFTWARE  
MUMPS

SYSTEMS  
TABS-8

FINANCIAL SUMMARY



1970  
7/69-6/70



## GENERAL

1970

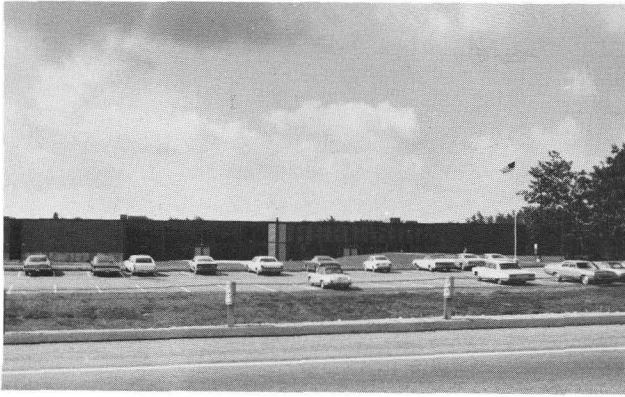

WESTFIELD

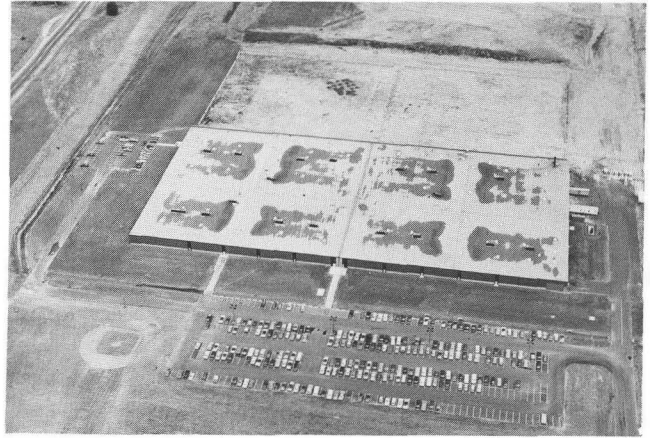

WESTMINSTER

### TWO NEW MANUFACTURING FACILITIES

In late 1969 and early 1970, DIGITAL built two new plants in Massachusetts—one in Westfield and another

in Westminster. Each plant gave the company an additional 250,000 square feet of manufacturing space.

## HARDWARE

1970



### PDP-8/E

Two important product announcements were made this year. The first was the introduction of the successor to the PDP-8/I. Less expensive than its predecessor, the PDP-8/E featured an OMNIBUS—a patented synchronous bus that handles bidirectional communication between system elements. By eliminating backplane wiring, and hence the need to rewire, the OMNIBUS greatly improved system reliability, simplified system configuration, and essentially eliminated system obsolescence. A single OMNIBUS contained enough slots to handle up to 32K words of core memory, or up to 10 peripheral controllers.

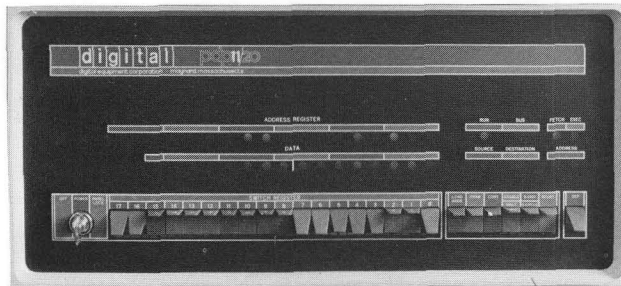

### PDP-11/20

The announcement of the PDP-11/20, the first of the PDP-11 family of machines, caused considerable stir in the minicomputer marketplace. The 16-bit machine was the first minicomputer to interface all system elements—processor, memory, and peripherals—to a single, bidirectional, asynchronous bus. The UNIBUS enabled fast devices to send, receive, or exchange data without intermediate buffering in memory.

Both the PDP-11 and the PDP-8/E used larger circuits boards than the earlier integrated circuit machines and were built on highly automated production lines using quality control, heat and stress testing procedures never before implemented.

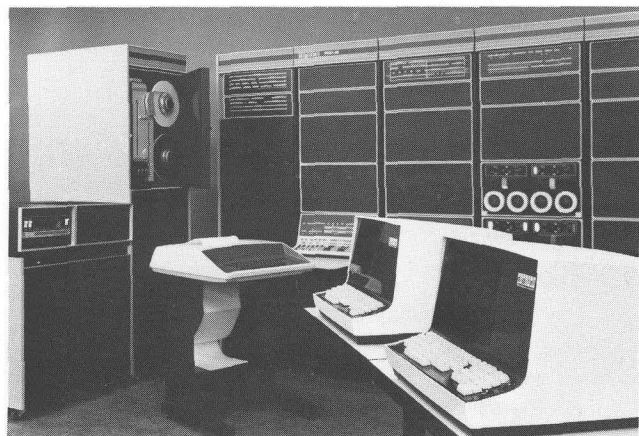
**SOFTWARE****1970****MUMPS**

With total systems packages playing an increasing role in the computer market, the introduction of MUMPS further enhanced the PDP-15 software. MUMPS, a general purpose data management language developed at Massachusetts General Hospital, allows up to twenty-two users to simultaneously access a data base held on disk. MUMPS-15 systems have applications in such areas as hospital information, stock and warehouse control. The success of many large PDP-15 configurations that were sold with the MUMPS software led to later development of a PDP-11-based MUMPS system.

**SYSTEMS****1970****TABS-8**

The first business system designed specifically for newspaper applications was installed by the Graphics Art Group in June. TABS-8 (Typesetting Applications Business System), a collection of business data processing programs that runs on the PDP-8/E, consists of six packages: Circulation, Advertising, PAI/MAIL, Payroll, Accounts Payable and General Ledger. The system was designed to handle the day-to-day detail work of the newspaper business by providing the information and reports needed to effectively manage overall operations. TABS-8 represented DIGITAL's first step in business data processing for the non-sophisticated end-user.

**FINANCIAL SUMMARY****FISCAL YEAR**

Total Operating Revenues	<b>1970</b>
Income Before Income Taxes	\$135,408,000
U.S. & Foreign Income Taxes	25,500,000
Net Income	11,100,000
Total Assets	14,400,000
Current Assets	114,821,000
Current Liabilities	94,535,000
Stockholders Equity	38,477,000
No. of Shares Outstanding at Year End	76,344,000
Net Income Per Share	29,019,000
EMPLOYEES AT YEAR END	\$50
SHAREHOLDERS AT YEAR END	5,800
	6,460



GENERAL  
MILESTONES  
GALWAY  
DIGITAL PARK

**HARDWARE**

PDP-11/15  
PDP-8M  
PDP-11/05  
THREE NEW PERIPHERALS  
VT05  
LA30  
TU10  
PDP-11/45  
RTM (PDP-16)

FINANCIAL SUMMARY

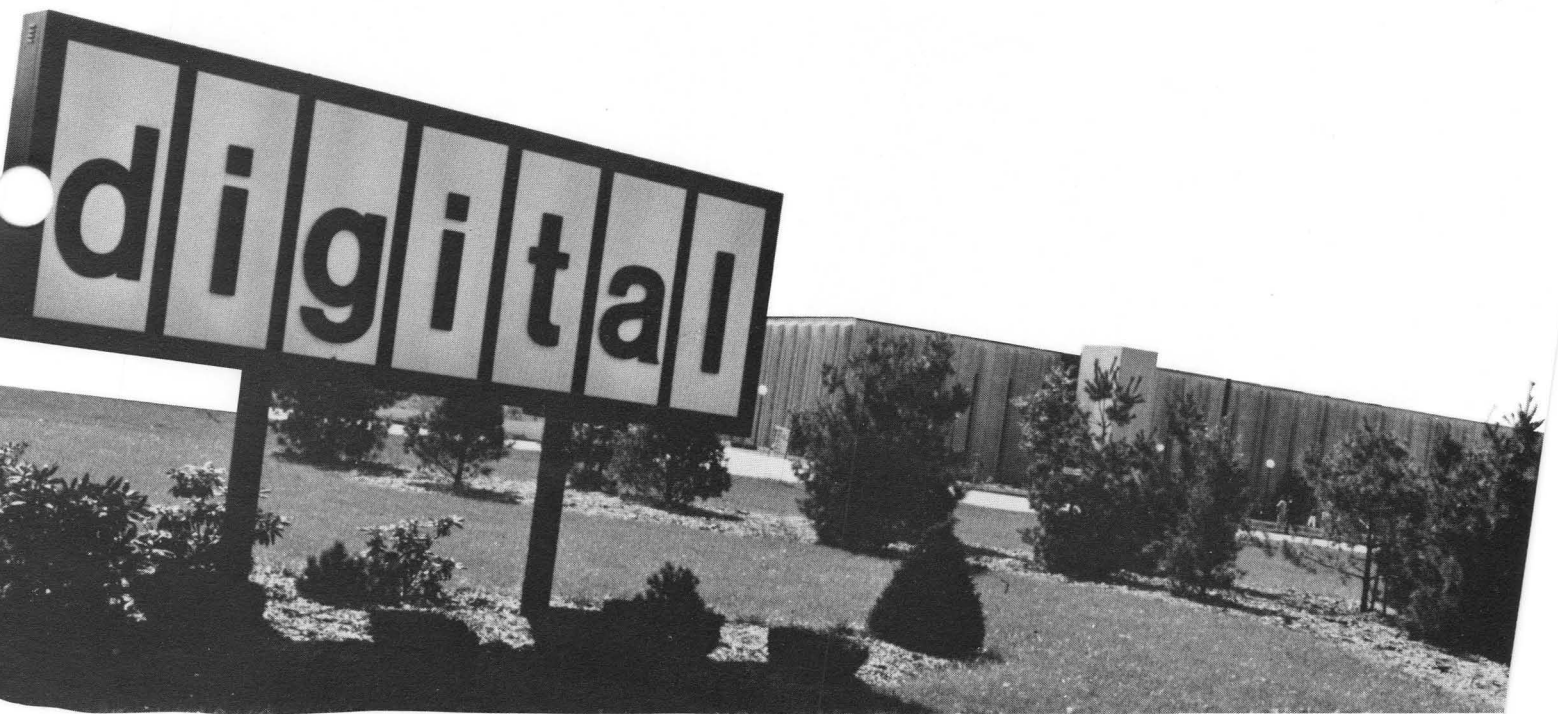

**1971**  
7/70-6/71

## GENERAL

1971

### MILESTONES

Two milestones were reached this year. The 15,000th installation was made, and DIGITAL became the second

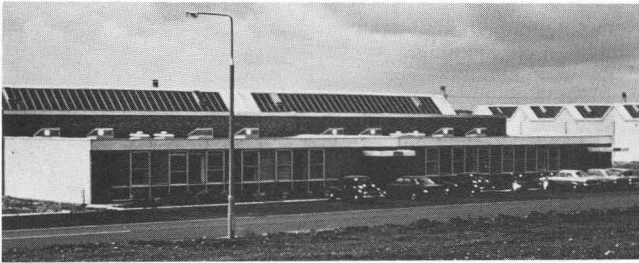

### GALWAY

Additional Plant facilities were added in Galway, Ireland, and expansion of the Westminster plant to 520,000 square feet was begun.

largest computer manufacturer in the U.S. in number of installations and the eighth largest in the world in dollar sales.

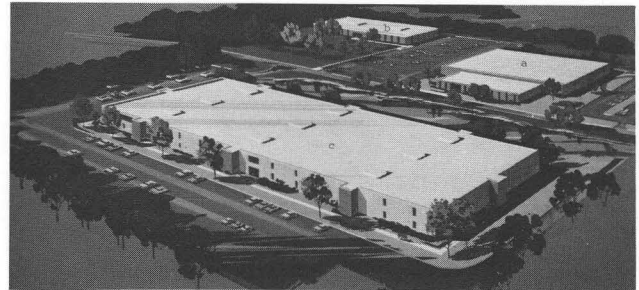

### DIGITAL PARK

In Maynard, plans were underway for an industrial park.

---

## HARDWARE

1971



### PDP-11/15

A smaller version of the PDP-11/15, was released in Q2 for the expanding OEM market.

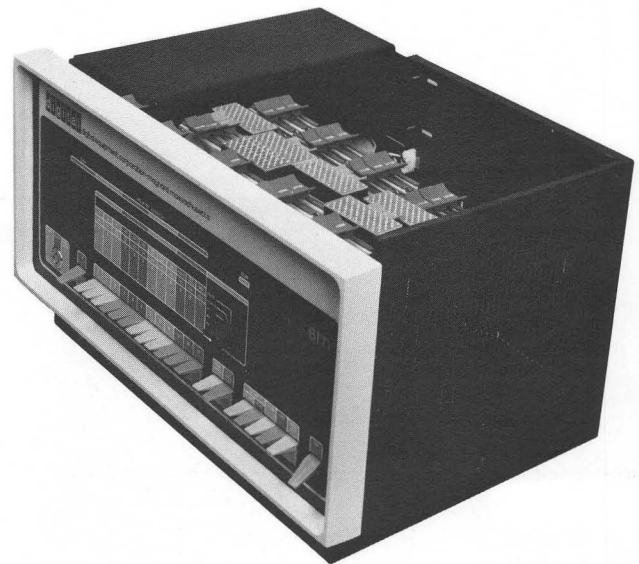

### PDP-8/M

The PDP-8/M, an OEM version of the 8/E, had only one OMNIBUS mounting block, so it could be packaged in half the space of the 8/E, offering price advantages for multiple unit purchasers.

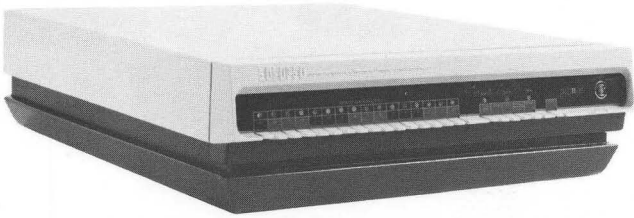

### PDP-11/05

Two more products aimed at the OEM market were released during this year. The PDP-11/05 made extensive use of large board technology, giving users an improved price/performance ratio.

### THREE NEW PERIPHERALS

Three new DIGITAL-manufactured devices were introduced at the 1970 Fall Joint Computer Conference: the LA30 DECwriter, a 30-character-per-second teletypewriter replacement terminal; the TU10 magnetic tape unit; and the VT05 alphanumeric keyboard terminal.



LA30



TU10

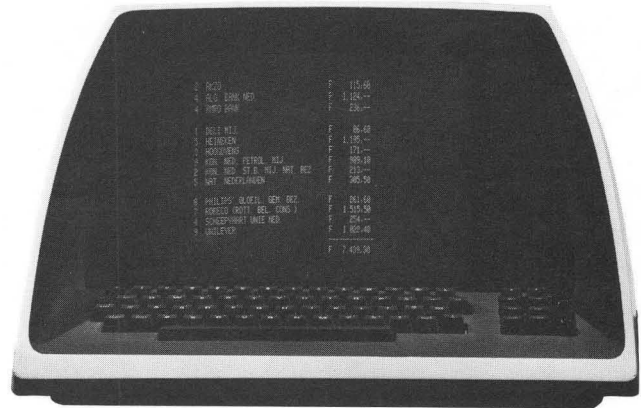

VT05



### PDP-11/45

DIGITAL entered the medium-scale computer market during the year with the PDP-11/45, the most powerful member of the PDP-11 family. Starting at a cost less than \$20,000, the 11/45 proved an excellent computational tool for large multi-user/multi-task installations. It combined three different types of primary memory: core, metallic-oxide semiconductor, and bipolar semiconductor and had memory management hardware to allow efficient memory utilization and expansion up to 128K. Dual-ported memories allowed overlapped computation for fast throughput. Other features included a greatly expanded floating point processor and the addition of several software systems developed specifically for the 11/45; RSTS/E, RSX-11D, and a substantially improved FORTRAN system.

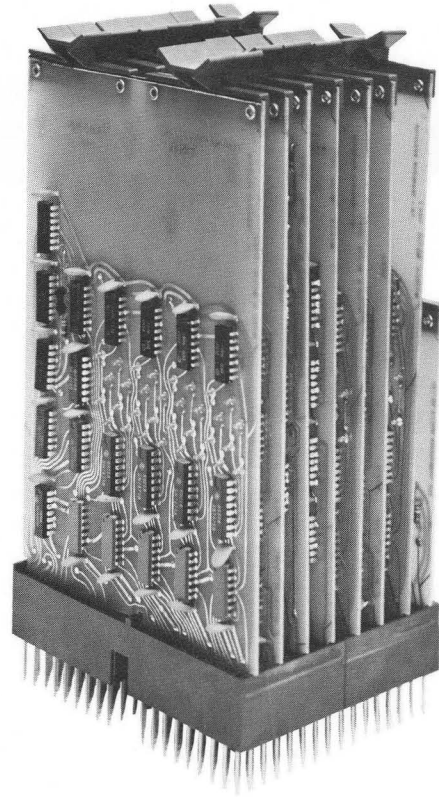

### RTM (PDP-16)

The PDP-16 began a new concept in small computers and digital controllers. Announced initially as the PDP-16 but subsequently renamed and now called RTMs (Register Transfer Modules), manufacture began in mid-year. This series of printed circuit modules can be tailored to any application and made to operate with or without programs. It can be used for dedicated functions in industry, research, education, and data communications where even a PDP-8/E could not be cost-justified. In terms of cost, the PDP-16 closed the gap between small logic modules and the smallest general purpose computer.

## FINANCIAL SUMMARY

FISCAL YEAR	1971
Total Operating Revenues	\$146,849,000
Income Before Income Taxes	18,500,000
U.S. & Foreign Income Taxes	7,900,000
Net Income	10,600,000
Total Assets	150,142,000
Current Assets	110,865,000
Current Liabilities	24,288,000
Stockholders Equity	125,854,000
No. of Shares Outstanding at Year End	30,717,000
Net Income Per Share	\$.35
EMPLOYEES AT YEAR END	6,200
SHAREHOLDERS AT YEAR END	7,420

GENERAL  
TAIWAN

HARDWARE  
PDP-16M  
PDP-8F

SOFTWARE

PHA-11  
RSTS-11  
NEW PDP-11 BASED PACKAGES  
DCM-11  
LAB-11  
IDACS-11

SYSTEMS

TYPESET-10  
DEC DATASYSTEMS: DDS-300,  
DDS-520  
TYPESET-11  
NEW PDP-10 MARKETING  
PHILOSOPHY:  
DECSYSTEM-10

FINANCIAL SUMMARY

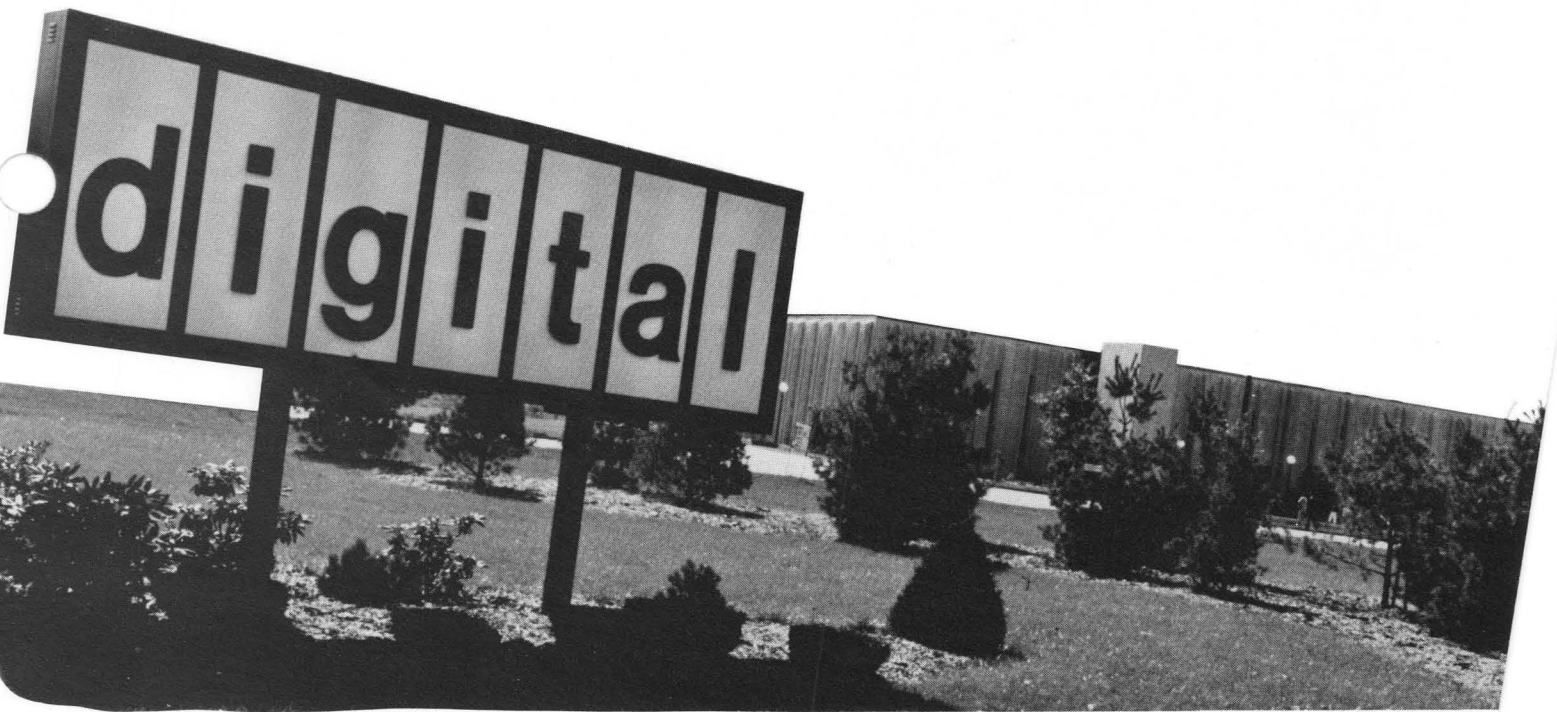

1972  
7/71-6/72



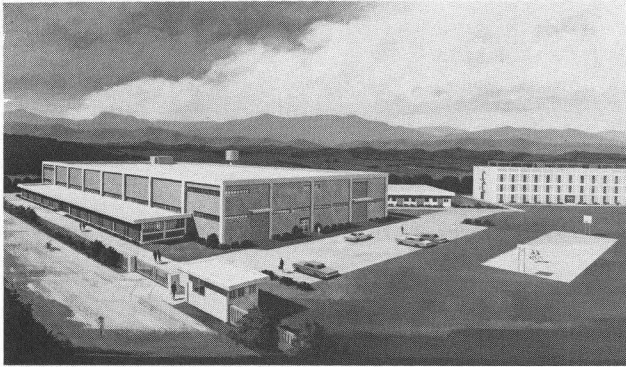

**TAIWAN**

After negotiations with RCA in late 1971, DIGITAL purchased their memory production division in Taiwan. This, together with advances in memory manufacture, allowed the company to decrease prices for most of its mini-computers.

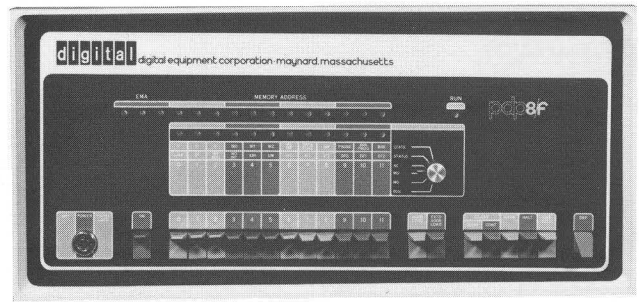

**PDP-8/F**

The PDP-8/F, an end user version of the PDP-8/M, was introduced in March. Like the 8/M, it had one OMNI-BUS but gave users the flexibility of the 8/E.

**HARDWARE**



**PDP-16/M**

The PDP-16/M, a small general purpose computer that used some of the RTM data options, was announced. Designed for customers who needed a limited machine for less than \$4K, it incorporated a programmable read-only memory and a variety of options to make a highly versatile device for the OEM, educator, and systems designer.

**SOFTWARE**

**NEW PDP-11 BASED PACKAGES**

Several new application packages were developed in 1971 around the PDP-11: DECcomm-11 for communications, LAB-11 for the laboratory, and IDACS-11 for industrial applications were the first.



**DCM-11**



**LAB-11**



**PHA-11**

Other announcements included the PHA-11 package for pulse height analysis and low-energy nuclear and electron spectroscopy applications...

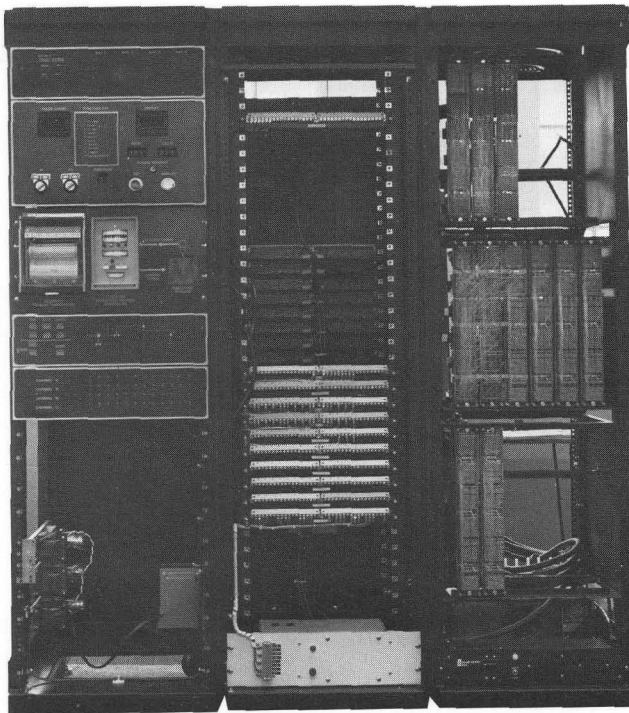

**IDACS-11**

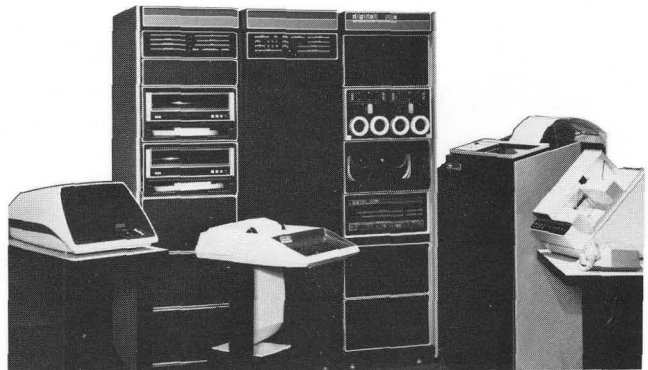

**RSTS-11**

...and RSTS-11, a resource timesharing system capable of supporting 16 simultaneous users. RSTS-11 was particularly well suited to commercial applications due to its sophisticated file handling and protection capabilities. The later addition of BASIC-PLUS, a more powerful version of the BASIC® language, greatly enhanced the RSTS systems' capabilities in the form of RSTS/E, a time-sharing system for education and computation center environments.



### TYPESET-10

TYPESET-10, a "total newspaper" system designed and implemented around the powerful DECsystem-10, was announced in March. A fully redundant, high-availability computer system operating within the multi-task TOPS-10 monitor environment, TYPESET-10 offered the capability of producing high-quality typographic output concurrently with all of the other computing requirements normally encountered within a corporate structure, such as payroll, employee records, budgeting, billing, and general data processing requirements.

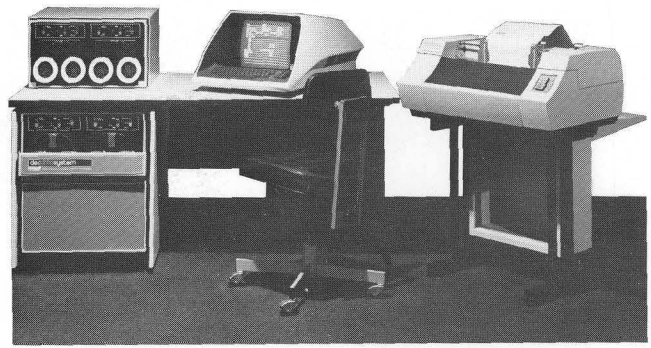

### DEC DATASYSTEMS: DDS-300, DDS-520

The formation of a Commercial Products Group led to the development of the DEC Datasystems series of business-oriented systems. These systems were aimed specifically at small commercial applications needing terminal capability not offered by small EDP computer system houses.

Software written for these systems included DIBOL and RPG (Report Program Generator). The DDS-300, the first in the series, was designed specifically for the office environment and consisted of a PDP-8/E-based system with a new Commercial Operating System, COS-300, that included DIBOL, SORT/MERGE utilities, F/B capability, and data entry package to run in the foreground.

This system was shortly followed by a PDP-11-based system. The DDS-520, based on the 11/05 processor, was a single-user batch system supporting the full line of business oriented peripherals.

### TYPESET-11

Finally, the Graphics Art Group followed the successful PDP-8 based typesetting system with a new PDP-11 based system running under the multi-user DOS operating system. TYPESET-11, later released under the RSX-11D operating system, allowed copy preparation, data flow control and system management to be performed simultaneously and entire publications to be stored, proofed, edited and corrected or revised before phototypesetting the text. Copy editing and rearranging, performed off-line at DIGITAL-developed VT20 video display terminals, uses the host computer's time only for data transmission. Proof copies can be obtained from a high-speed line printer before finalized text is output to on-line photo-composition machines or paper tape punches.

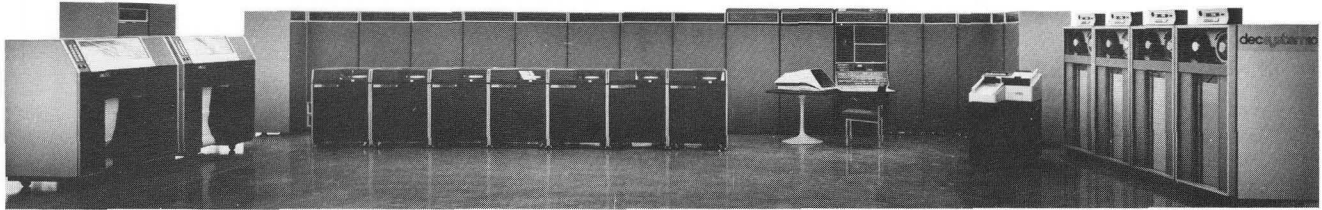

**NEW PDP-10 MARKETING PHILOSOPHY:**

**DECSYSTEM-10**

Late in 1971 the marketing philosophy of the PDP-10 group was changed, and the DECsystem-10 line was introduced. It was decided that the entire DECsystem-10 line would use the same basic monitor system to give users an unequalled expansion capability.

The DECsystem-10/40 and 10/50 used the established KA10 processor; a larger system, the 10/70, included the new and faster KI10 processor; and the 10/55 and 10/77 dual processor configurations that used the KA10s were added. Systems ranged in price from \$400,000 to over \$1.2 million.

**FINANCIAL SUMMARY**

<b>FISCAL YEAR</b>	<b>1972</b>
Total Operating Revenues	\$187,553,000
Income Before Income Taxes	25,800,000
U.S. & Foreign Income Taxes	10,500,000
Net Income	15,300,000
Total Assets	192,416,000
Current Assets	134,765,000
Current Liabilities	47,609,000
Stockholders Equity	144,807,000
No. of Shares Outstanding at Year End	31,029,000
Net Income Per Share	\$.50
<b>EMPLOYEES AT YEAR END</b>	<b>7,800</b>
<b>SHAREHOLDERS AT YEAR END</b>	<b>15,430</b>



**HARDWARE**

PDP-11/10

PDP-11/40

LPS-11

GT40

**SOFTWARE**

CAPS-8

RSX-11D

CAPS-11

**SYSTEMS**

UNICHANNEL-15

PDP-15/76

RK-15

GRAPHIC-76

**FINANCIAL SUMMARY**



**1973**

7/72-6/73

## HARDWARE

1973

Two new end-user versions of the PDP-11/20 were announced.



### PDP-11/10

The PDP-11/10 had additional features such as 4-level priority interrupt and multiple accumulators to allow it to run all PDP-11/20 software.



### PDP-11/40

The PDP-11/40, offering approximately twice the processing power of the earlier 11/20, was also introduced. The floating point package, offered as an option, made the cost slightly lower than that of the 11/20.

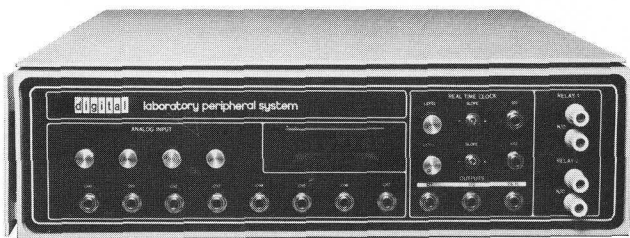

### LPS-11

The LPS-11, introduced in August, was designed as a low-cost, lab data acquisition system. Housed in a 5¼'-high box, the unit consisted of options designed specifically for the lab, but which could also be used in various other data acquisition markets. The various subsystems included a 12-bit A/D, D/A and scope control, a real-time clock, and a 16-bit digital I/O register. The LPS interfaced to the PDP-11 family by means of the UNIBUS.

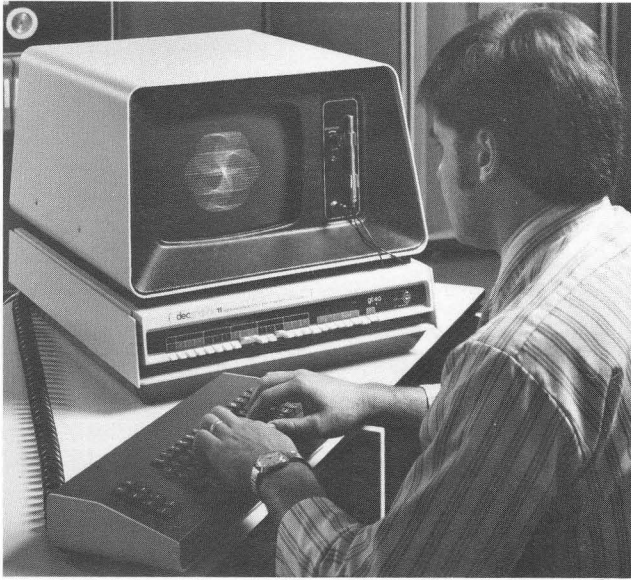

### GT40

In October, the GT40 graphic display system was introduced to fulfill the need for a fast, uncomplicated graphics system. A programmable display with standard communication interface, alphanumeric terminal and light pen, the GT40 incorporated an 11/10 minicomputer, making the system expandable with mass storage as well as with other I/O options. Used both as a smart terminal to a host computer and as a stand-alone system, it proved to be a success even before software was announced for it.

## SOFTWARE

1973



### CAPS-8

The convenience of tape cassette vs. papertape procedures was first demonstrated on DIGITAL machines in May of this year with the release of a cassette programming system on the PDP-8/E, CAPS-8 gave users a keyboard monitor, I/O facilities at the monitor level, and a library of system programs, with a minimum configuration of an 8K PDP-8/M, TAB DECcassette, and keyboard terminal.



### RSX-11D

In May, the PDP-11/45 Product Line announced a new software system: the RSX-11D Real-Time Executive. Aimed at the sophisticated end-user, RSX11-D offered users real-time capabilities in a powerful system that included a choice of two computers, the 11/40 or 11/45, a sophisticated real-time executive, on-line program development, complete device handling capabilities, and total system protection. Typical applications were in the lab, industrial, computation, and OEM markets.



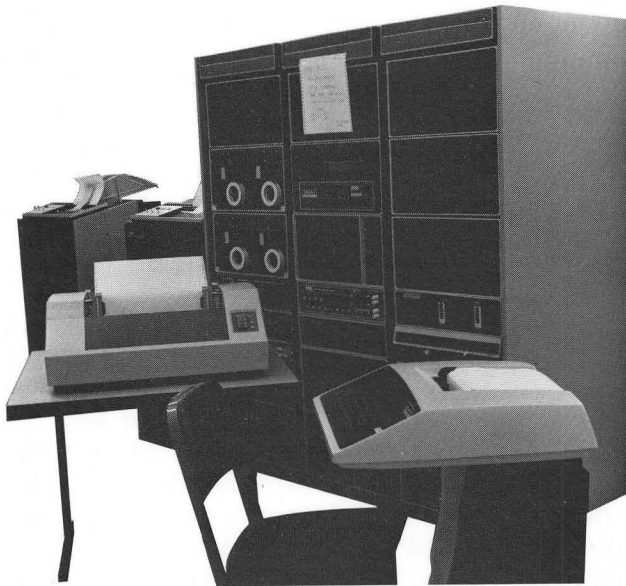

### CAPS-11

CAPS-8 was followed in late June with the release of the CAPS-11 software, greatly enhancing DIGITAL's place in the PDP-11 small systems marketplace. Using cassettes as a file-structured medium to replace papertape as a development and distribution medium, CAPS-11 supports a dual cassette drive, a DECwriter, a teletype or VT05, and a line printer on a minimum 8K memory configuration with possible expansion up to 28K.

## SYSTEMS

1973

### NEW PRODUCTS FOR THE PDP-15

#### UNICHANNEL-15

The announcement in November of the UNICHANNEL-15, a new peripheral processor for the PDP-15 that utilized the 11/05 minicomputer, foreshadowed the introduction of two other new PDP-15 products. The UC-15 provided the PDP-15 with a second general-purpose processor and an additional UNIBUS. Additional components of the new system were a memory multi-

plexer that allowed the PDP-15 and 11/05 processors to share common memory and an "interrupt link" that provided a second means of interprocessor communications.

This announcement was followed in December by the introduction of the dual-processor PDP-15/76 and the RK15 cartridge disk system, both utilizing UC-15.

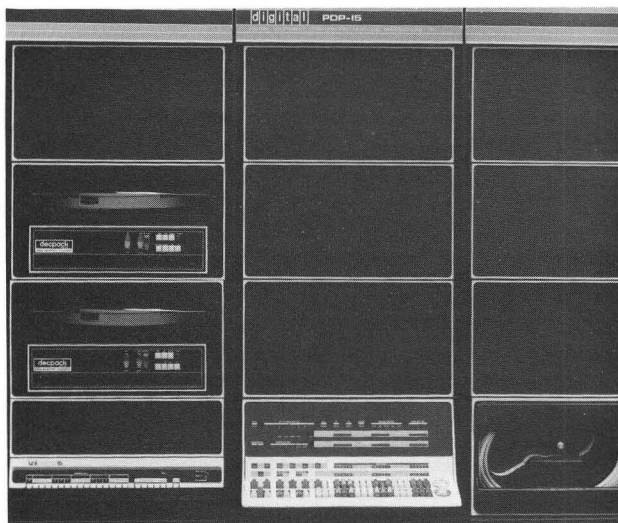

#### PDP-15/76

The PDP-15/76, a multi-processor, fully-integrated, hardware/software system, was designed to handle simultaneous applications such as data acquisition and data analysis, batch computation and I/O spooling to printers or plotters, graphics and plotting, and graphics and data acquisition. The system's central processor performs computation, monitoring, and file management; an integrated floating point processor performs high speed computations with up to 54-bit accuracy; a high-speed I/O processor channel drives graphics processors, A/D converters, industrial controllers, and mass storage devices; and the 11/05 peripheral processor provides automatic spooling. The system runs under DOS/BOS-15, MUMPS-15, and RSX-PLUS III, has eight applications packages, a number of utility packages, FORTRAN, and starts for under \$50K.

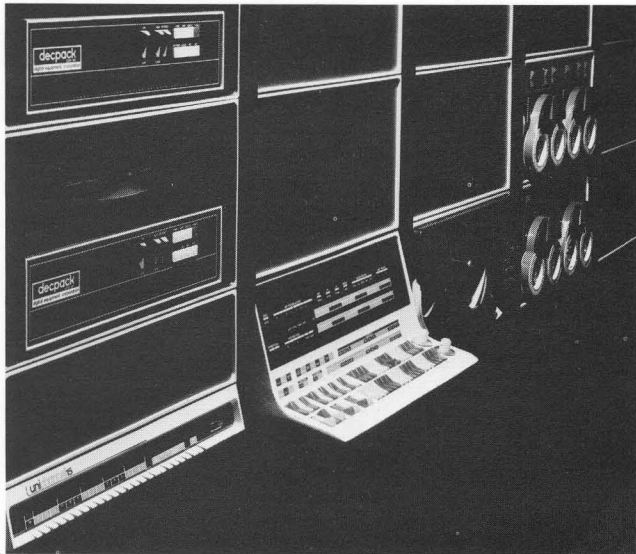

### **RK-15**

The RK15 Cartridge Disk System, a complete sub-system consisting of the UC-15 peripheral processor, an RK11E disk controller, and RK05 cartridge disk drive, was also introduced at this time. The system, which supports both DOS- and BOS-15 as either systems or data storage devices, gave PDP-15 users a convenient, low-cost cartridge disk system that allows them to convert a PDP-15 into a dual processor system.



### **GRAPHIC-76**

Shortly after its announcement, the PDP-15/76 also entered the graphics market with the GRAPHIC-76, a PDP-15/76 with the GT15 stroke vector front-end and software capable of supporting four consoles under RSX-PLUS III.

## **FINANCIAL SUMMARY**

<b>FISCAL YEAR</b>	<b>1973</b>
Total Operating Revenues	\$265,469,000
Income Before Income Taxes	38,600,000
U.S. & Foreign Income Taxes	15,100,000
Net Income	13,500,000
Total Assets	287,397,000
Current Assets	216,575,000
Current Liabilities	63,851,000
Stockholders Equity	223,546,000
No. of Shares Outstanding at Year End	33,237,000
Net Income Per Share	\$.72
EMPLOYEES AT YEAR END	13,000
SHAREHOLDERS AT YEAR END	14,226



## GENERAL

MARKET GROUP  
REORIENTATION  
SOFTWARE PRODUCT  
LICENSING  
NATIONAL ACCOUNTS  
PROGRAM  
RIMS  
MARLBOROUGH  
DIGITAL PARK  
COMPONENTS GROUP

## HARDWARE

14 CONTROLLERS:  
PDP-14/30, /35  
PDM70  
PROM-8M  
MPS COMPUTER PROGRAM  
RJS03/04  
PDP-8A MINIPROCESSOR  
8/A MODULE KIT  
8/A OEM PACKAGE  
TU16

## SOFTWARE

RT11  
RSX-11M  
RSX PLUS III

## SYSTEMS

STANDARD SYSTEMS  
LAB-11E10  
IND-1150  
IND8/C  
DDS-500  
GT44  
DECSET-8000  
GT42  
DATA COMMUNICATIONS  
PACKAGES  
DDS-340  
EDUSYSTEMS-100, 200, 250  
DECLAB

## FINANCIAL SUMMARY



**1974**

7/73-6/74

**MARKET GROUP REORIENTATION**

The start of FY'74 witnessed a significant restructuring of corporate marketing policy. The identification of many distinct customer markets resulted in a shift away from strictly product-oriented groups to discrete market groups,

each serving distinct customer markets. Concurrent with this change in marketing strategy, the field sales force was realigned to reflect a market orientation.



**SOFTWARE PRODUCT LICENSING**

Another important change occurred in the area of marketing software products. The recent trend in the industry had been heading toward licensing of software products, both because it was no longer feasible for a company to bundle the price of software in with hardware prices, due to the increasing costs of software development, and because of the need for companies to protect their manufacturing rights to their software. So by early FY'74, corporate policy had evolved to the point that many software products were not actually sold outright to customers; rather, customers paid a license fee that entitled them to use a particular software system on a single specified Digital CPU.

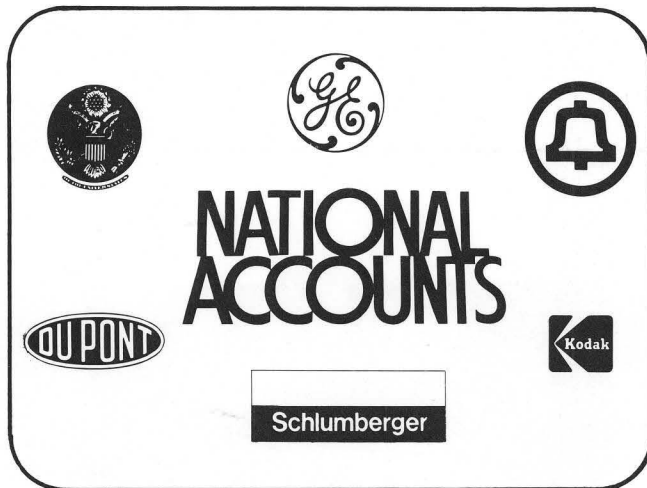

**NATIONAL ACCOUNTS PROGRAM**

Also in July, a National Accounts Program was established to provide better servicing of large, multi-divisional, geographically dispersed customers such as General Electric, Bell Telephone, the U.S. Government, Kodak, Schlumberger, and Dupont. A similar type of program was planned for implementation in the U.K. and Europe in the future.

**RIMS**

In November, the Field Service Regional Computer Project became a reality with the installation, on a turn-key basis, of an 11/40 computer and Regional Inventory Management System (RIMS) at the Mid-Atlantic Field Service Regional Office in Princeton, N.J. With planned installations in Q3 and Q4 for other Regional Field Ser-

vice Headquarters throughout the world, the RIMS system was designed to provide timely and accurate information to field management on the status and activity of spare parts in the Regional Stockrooms. System features included forecasting, stock record keeping, accounting information, and back order/open order inventory.

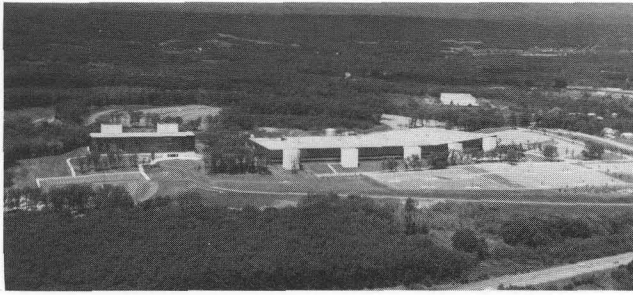

### MARLBOROUGH

In January, the corporation purchased RCA's Marlborough facility, adding another 700,000 sq. ft. of administrative and manufacturing space. Its first occupants were the DECsystem-10 group.

### COMPONENTS GROUP

The formation of a new Components Group was announced in June. Located in the Tower at the new Marlborough facility, the group was created to sell independent peripherals totally unbundled to large-volume customers, with the intention of reducing prices and in-

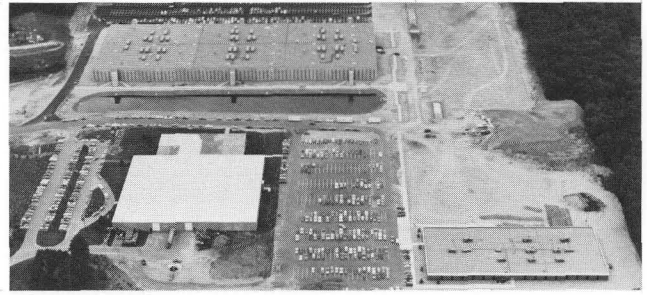

### DIGITAL PARK

Meanwhile, in Maynard, the new general purpose administration building was occupied, completing the DIGITAL PARK.

creasing volume availability of products through economies of scale in production and merchandising. Products initially offered included existing dual-cassette tape systems, data-entry keyboard terminals, logic modules, microprocessors series modules, and the PDP-8A mini-processor.

## HARDWARE

1974

### 14 CONTROLLERS: PDP-14/30,/35

September ushered in the second generation of programmable controllers to the Industrial line of products.

The introduction in Detroit included two new controllers, the Industrial 14/30 and the larger 14/35, and a new programming terminal, the VT14. These new products embodied significant advances in programmable controllers when compared with the original PDP-14, the world's first PC when originally introduced in 1969.



The new controllers supported approximately twice as many digital inputs and outputs using unique single point plug-in signal converters. A significant advantage is the large number of internal logic functions available to the user at no additional cost for timing, counting and shift registers.



These added capabilities are used by control engineers to effect better control methods in a wide variety of applications in all major industries. Initial shipments of the second generation of 14 Controllers were applied in automotive, chemical processing and warehousing control applications.

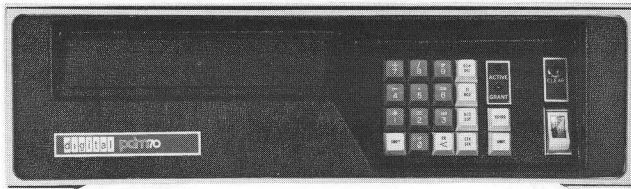

### PDM70

A remote data acquisition system that provides an economical means of collecting and moving data from instruments and sensors to remote processors, the PDM70 is capable of standalone operation using its own memory and control or operation in a slave mode from a processor. The system is totally ASCII-oriented and is easily interfaced to computers via 20-mA current or EIA levels. The variety of option cards includes A/D, D/A, bit-parallel in/out, character-parallel in/out, and bit-serial in/out.

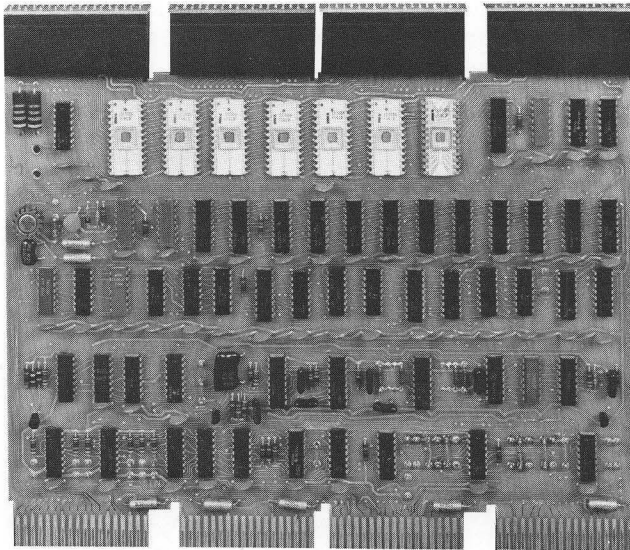

### PROM-8M

The OEM group's announcement in November of a 1K programmable Read-Only memory, which had 256 read/write locations out of a total of 1K memory locations, opened up new application areas for the use of mini-computers. By combining the PROM and a PDP-8 CPU, the OEM group was able to offer the lowest-priced PDP-8 ever (the PROM-8M) at \$2750 for the 1K PROM and \$3500 for the 2K PROM. Typical applications for the PROM-8M included repetitive manufacturing operations, control applications, data collection, and instrument monitoring and measurement.

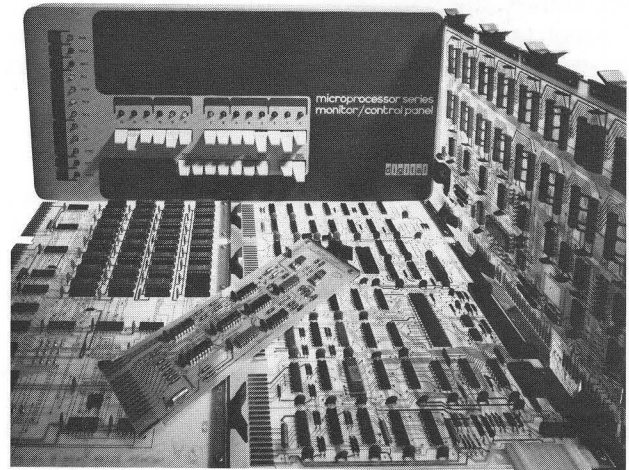

### MPS COMPUTER PROGRAM

The MPS (MicroProcessor Series) product family represents DIGITAL's first entry into the world of LSI (Large Scale Integration) technology computer products. The MPS modules have been designed to supply users with reliable, low-cost microprocessor systems that can be used in process/control and data formatting or preprocessing applications. For ease of application, the MPS user can choose between an MPS self-assembler software package or elect to utilize an assembler package designed for operation on a PDP-8. An MPS based version of the high level language, FOCAL (FOrmula CALculator), is also offered through the Software Distribution Center, giving MPS compatibility with other FOCAL computer systems. To facilitate hardware interfacing, MPS is designed to be complemented by a wide variety of interfacing products offered through DIGITAL's Logic Products Group. Thus, the MPS has been designed to be an extremely flexible, inexpensive, hardware/software microprocessor system.



### RJS03/04

In February, the latest in fixed head disk systems was announced for the PDP-11 family. The first in the line of high-performance peripherals designed for applications requiring high speed and reliable on-line storage, the RJS03 and RJS04 feature: fast access—8.5 milliseconds at 60 Hz, 10.2 milliseconds at 50 Hz; high speed transfer rates of 4  $\mu$ s per 16 bit word for the RJS04, 4 or 8  $\mu$ s for the RJS03; real-time lookahead on multidrive systems; high data reliability; and U.L. approval.

The RJS03 includes a controller and rackmounted RS03 fixed head disk drive with a 256K 16-bit word storage capacity.

The RJS04 includes a controller and RS04 disk drive with 512K 16-bit word storage capacity. Both can be expanded with up to 8 drives per controller.

### PDP-8/A MINIPROCESSOR

*At the National Computer Conference in May, the OEM group introduced the PDP-8A minicomputer.*

*Designed with currently available semiconductor components, the PDP-8A is not dependent on custom LSI chips. Based on the OMNIBUS concept, the PDP-8A provides the traditional PDP-8 values of reliability, com-*

*patibility, and performance, offering a complete range of available peripherals, proven software, field support organization and manufacturing capabilities.*

*Two versions were displayed, a module kit version and a packaged configuration.*

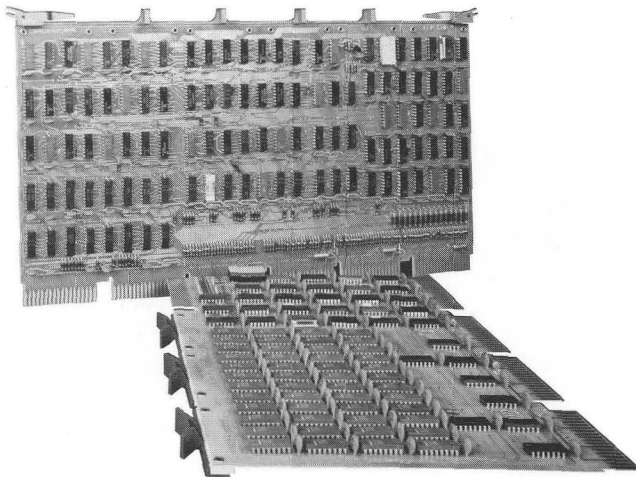

### 8/A MODULE KIT

The Module Kit consists of a miniprocessor on hex size board and a quad size memory board. Several memory types are offered, including Read/Write RAM, ROM and PROM in 1K, 2K and 4K increments, up to 32K.



### 8/A OEM PACKAGE

In the packaged version OEM's can choose the type and quantity of memory they need plus a 19-inch wide chassis, a power supply, cooling fans, an eight slot OMNIBUS, and an operator's function panel. The PDP-8A package prices began at \$1745 for the 1K RAM model.



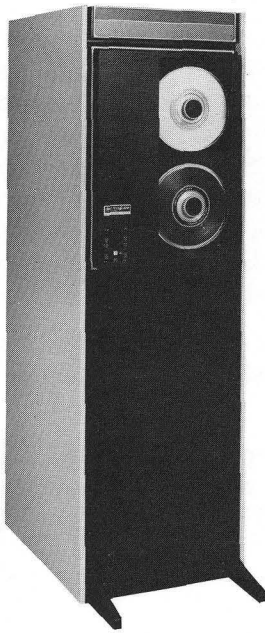

### TU16

In June, the second in the line of high-performance peripherals was announced.

The TU16 expanded DIGITAL's magnetic tape product line. Offered in both 800 and 1600 bpi or 800 bpi only, the TU16 provides considerable second generation improvement over its still viable predecessor, the TU10.

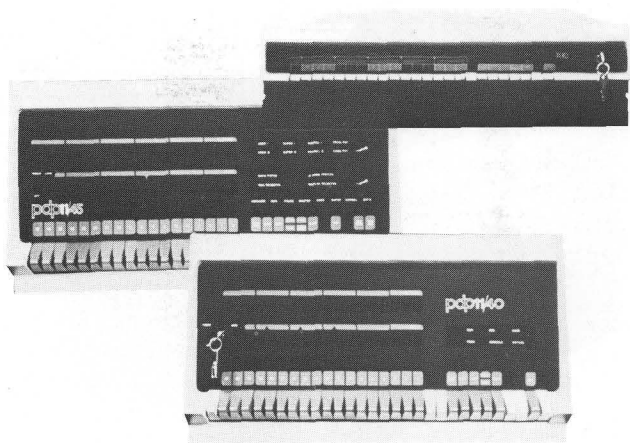

### RSX-11M

A real-time, multi-programming, program-development system with a disk-based operating system, RSX-11M offered the user the following features: it can operate on all PDP-11 processors and is a fully compatible subset of RSX-11D; it can operate with or without memory management (memory management support is a system generation option) in a 16K memory PDP-11 with 8K available for either foreground or background operation and provide simultaneous background and foreground operation in systems with 24K or more memory; and can support both synchronous and asynchronous communications hardware.

## SOFTWARE

1974

### RT-11

DIGITAL's entrance into the low end of the real-time market came in July with the announcement of RT-11. With its single-job monitor and F/B monitor, RT-11 was designed for the single user involved in program development and/or real-time applications, providing fast, simple, on-line access to any PDP-11 processor with at least 8K of memory and mass storage (16K words for F/B). The system offers the user two high-level languages, BASIC/RT-11 and FORTRAN IV-RT-11 and is upwards compatible for users who need to grow from CAPS-11. Basic system components consist of an 8K PDP-11/10 CPU, LA36, cabinet, Cassette, Bootstrap, and RK-11 disk cartridge system.



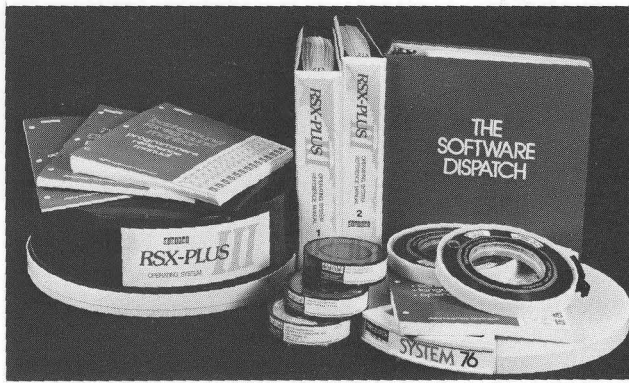

### RSX PLUS III

In late Q4, the PDP-15 Group announced the latest monitor for the PDP-15, RSX PLUS III, a real-time/batch, multi-programming system. Highlights of the new system, which had built in many features and improvements to its predecessor, RSX PLUS, included: upwards compatibility with RSX PLUS; UNICHANNEL support for spooling and multiprocessing; time slicing over a task priority range, on-line repartitioning, on-line addition of new devices, RSX and DOS co-resident on disk; improved RSX BATCH and Task Development.



IND-1150

## SYSTEMS

1974

### STANDARD SYSTEMS

Along with the change in market orientation occurred an increasing emphasis on selling total systems. In keeping with the industry-wide trend, DIGITAL adopted the Standard Systems concept, which specifies a complete, ready-to-run system, provides an optimum system configuration, allows faster deliveries, and gives customers the best value for their money. Standard Systems are presently offered by the LDP and Industrial Products Groups.

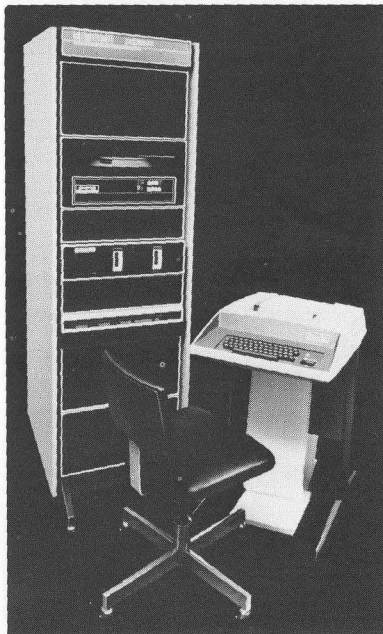

LAB-11 E10



IND8/C



### DDS-500

In July, the Business Products Group (formerly the Commercial Group) introduced their new DEC Data System 500 series. This series, which replaced the earlier 11/05-based series, utilized the PDP-11/40, 11/45 and 11/50 computers, together with several comprehensive operating systems—Commercial Operating System, Commercial Time Sharing System, and Commercial Data Management System (MUMPS)—to provide considerable flexibility to meet the needs of the commercial user.



### GT44

The GT44 was added to the line of graphics products in September. Designed for the user who needed an operating system with graphics capability yet did not need the power and sophistication of the PDP-15, the GT44 represented a price/performance breakthrough due to its “mini-system” concept. This concept simply means manufacturing the minimum “system” rather than the sum of its parts, hence passing considerable savings on to the user. The GT44 offers a complete system—both hardware and software—with a sophisticated operating system (RT-11) and a high-level language, BASIC-GT, for program development.

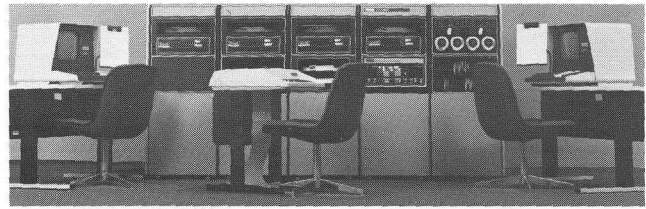

### DECSET-8000

In October, the first installation was made of the DECSET-8000, a multi-task, computerized typesetting system that provides the combined capabilities of four systems. A production and editing system permits both on-line and off-line editing. A complete classified ad system also produces transient billing data for the TABS-8 advertising business system. A complete wire service system includes stripping, storage, and editing, and a production management system facilitates continuous copy flow through each stage of production, continuously updated file information and production statistics, and classified billing information.

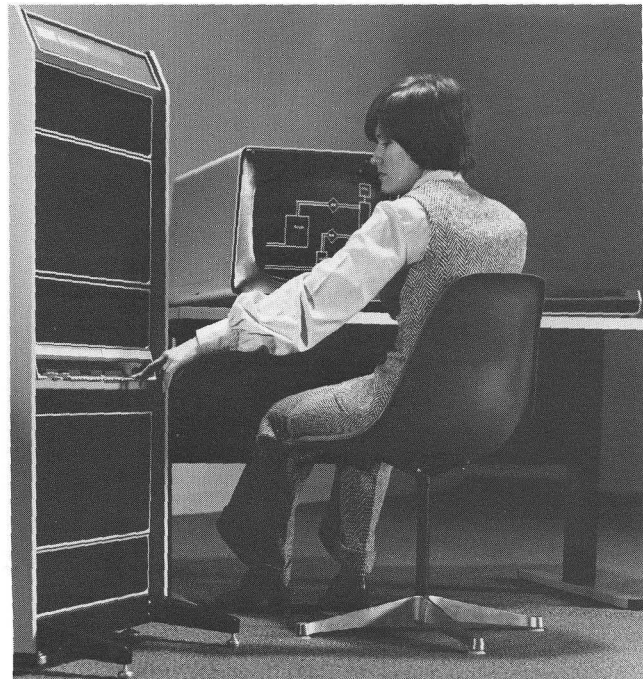

### GT42

The Graphic Display Systems Group also announced at this time its latest product, the GT42. An expandable, intelligent graphics terminal that performs the same functions as the GT40 but features a “big box” 11/10, the GT42 is mounted in a short cabinet that will accommodate up to 16K of core plus a 17” CRT that gives a 50% increase in viewing area over the GT40. FOCAL-GT software on paper tape accompanies the system, giving it the capability to communicate with a host computer, but with the 11/10 performing computation and program execution so that it can function as a standalone system.



### DATA COMMUNICATIONS PACKAGES

During the fall, the DECcomm Product Line introduced several new software products. DOS-COMTEX was announced in November, followed in December by two new remote computer systems, DOS-2780 and CORE-HASP.

DOS/COMTEX, a disk Communications Systems Base added device support and file-handling capability for COMTEX users.

The DOS-2780 Remote Computer System allowed data transmission between a PDP-11 and a central IBM 360/370, as well as transmission between two PDP-11's emulating IBM-2780 remote batch operation.

The new CORE-HASP Remote Computer System permitted transmission of jobs prepared on punched cards over leased or switched lines to an IBM-360 OS/HASP or OS/HASP System for processing and simultaneous reception of output from an IBM HASP station on a line printer.



### DDS-340

Concurrent with the Education Products and Display Systems announcements, the Business Products Group announced the expansion of their 300-series with the DDS-340, an inexpensive, general purpose, multi-terminal system featuring foreground/background and multi-terminal DIBOL (MTD). The minimum hardware configuration requires a DDS-340, 4K of memory, and a VT05 for F/B; 8K of memory and an additional VT05 for MTD. The system supports up to seven terminals, 4 RK05 disks, and a papertape reader/punch.

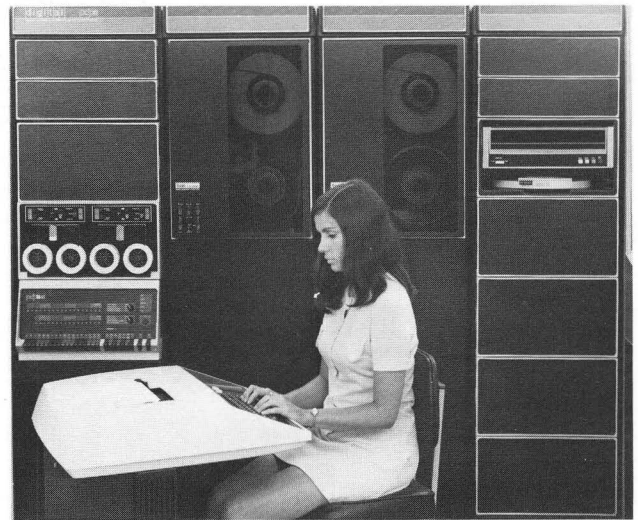

### EDUSYSTEMS-100, 200, 250

In March, the Educational Products Group extended its product line offering with EDUsystems-100, 200, and 250.

EDUsystem-100 is a one-to-eight-user, core-only system that uses a very powerful BASIC language processor. EDUsystem-200 is a 100 with the added capability of employing files as a main storage device. EDUsystem-250 adds the foreground/background feature of RT11 to EDUsystem-200, allowing the user to run from one-to-eight tasks under multi-user BASIC simultaneously with one FORTRAN IV or assembly language task.



### DECLAB

The first DECLAB shipment was also made in March. DECLAB was the second of the new line of "mini systems" that enable customers to realize substantial savings when ordering specific configurations for their facilities. The new system price of \$37,500 was 20% below the Company's previous equivalent systems.

System components are a PDP-11/40 minicomputer with 16K of memory, independent graphics processor, 12-inch CRT display, two disk packs, LPS-11, and DECwriter. Software consists of RT-11 and SPARTA, a new, modular signal processing software package.

## FINANCIAL SUMMARY

<b>FISCAL YEAR</b>	<b>1974</b>
Total Operating Revenues	\$421,884,000
Income Before Income Taxes	68,900,000
U.S. & Foreign Income Taxes	24,500,000
Net Income	44,400,000
Total Assets	440,270,000
Current Assets	324,156,000
Current Liabilities	85,536,000
Stockholders Equity	339,645,000
No. of Shares Outstanding at Year End	35,796,000
Net Income Per Share	\$1.27
EMPLOYEES AT YEAR END	17,600
SHAREHOLDERS AT YEAR END	14,393

GENERAL  
TELCO  
MILESTONE

**HARDWARE**

RP04  
LA36  
AR11  
VT-11  
VT50 DECScope  
KL-10  
TU70  
8/A-200, 400  
TU45  
PDP-11/04  
LSI-11  
PDP-11/70  
ICS, ICR  
NEW SYNCHRONOUS  
MULTIPLEXER: DV11  
TS03  
RX01  
PDP-11/03  
VT55

**SOFTWARE**

RTS-8  
IAS  
FORTRAN IV-PLUS  
PDP-11 COBOL  
DECNET

**SYSTEMS**

DATASYSTEM 535  
DECCOMM 600  
PDP-8/A BASED SYSTEMS  
CMS/1  
DEC DATASYSTEM 310  
CLASSIC  
PDL  
XVM SYSTEMS  
INDUSTRIAL 850 AND  
840 SERIES

**FINANCIAL SUMMARY**



**1975**  
7/74-6/75

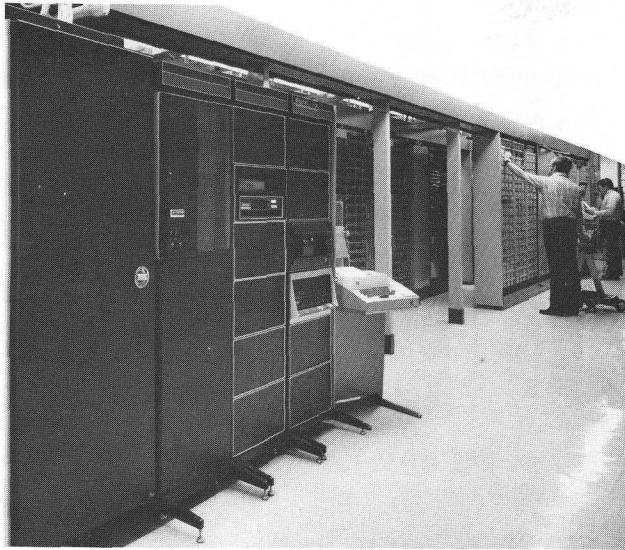

**TELCO**

On July 1st, the Telephone Industry Products Group, which had operated under the DECcomm umbrella since 1972, was officially announced as a separate product line. By thus dividing the Communications Group, in recognition of the great business potential of the telephone industry, DIGITAL increased its ability to concentrate on developing all aspects of the telephone business, through both Bell Labs/Western Electric and directly to Bell and independent operating companies.

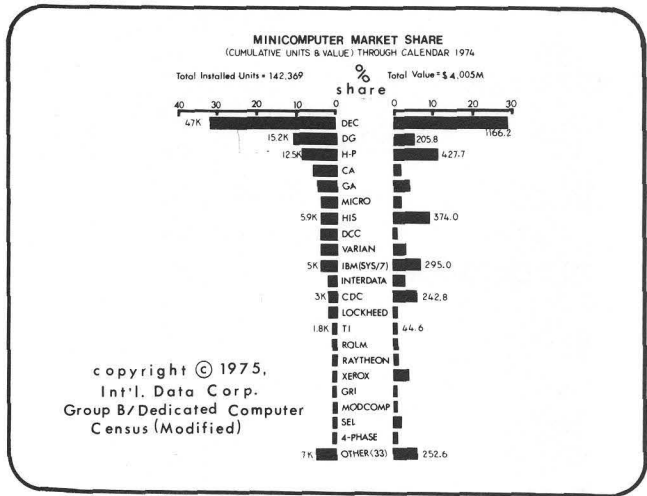

**MILESTONE**

*During the year, the company installed its 50,000th computer system and maintained its standing as the leading mini-computer manufacturer, both in terms of market share and dollar value.*



**RP04**

In July, a new high-performance mass storage device was introduced. The RP04 disc-pack drive, a low-cost-per-bit, direct access device for use on PDP-11/35, 11/40, 11/45, 11/50 and DECsystem-10 computers, represents a new generation of DIGITAL's mass storage disc devices. Features include 88 million bytes of formatted capacity, a transfer rate of 1.25 microseconds per byte, 36 millisecond average access time, error detection/correction, overlapped positioning with multiple drives, and the latest in reliable reading and recording techniques.

Also available is a programmable option, designated Dual Access, which allows two computers to share up to 8 RP04's.



### LA36

In August, a month that put many new products into the marketplace, a new generation of keyboard terminals was heralded by the announcement of the LA36 DECwriter II. The DECwriter II uses the latest technology to provide greater functionality at substantially lower prices than the LA30 DECwriter, which it replaces. Compatible with existing LA30 software and verified on all the major operating systems, the LA36 provides up to 132 column print capability, adjustable-width tractor paper feed system, upper and lower case character printing, up to six part paper handling, quiet operation, 7 x 7 dot matrix print head, and a multi-key rollover keyboard, which uses calculator type technology. True 30 cps operation, whereby no fill characters are needed for carriage return/line feed, is accomplished by buffering the characters received during a carriage return and line feed and activating 60 cps print mode to catch back up to the communications line.

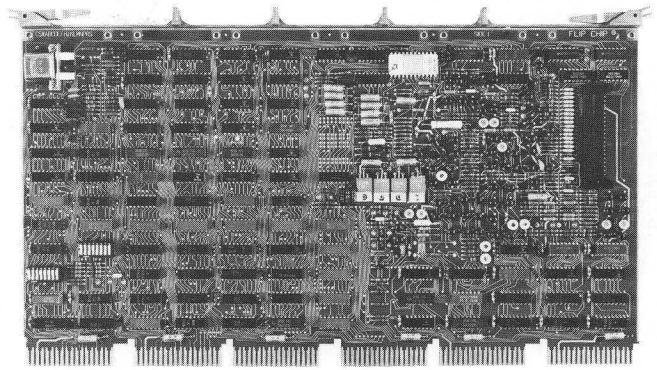

### AR11

The LDP Group added in August a new, cross-product line analog subsystem to its line of data acquisition subsystems for the PDP-11. At one-half the price of competitive systems, the AR11 combines a 16-channel A/D, scope control, and real-time clock on one board, in addition to providing its own power supply, derived from the +5 V logic power used by the CPU. Subset compatible with the LPS11, the AR11 is supported under BASIC®, FORTRAN, and Lab Applications with only slightly modified LPS software.



### VT-11

A new UNIBUS option, the VT-11 Display Subsystem used in GT42 and GT44 systems, was announced by the Graphic Display Systems product line in August, making graphics capability available to a wider range of PDP-11 users.



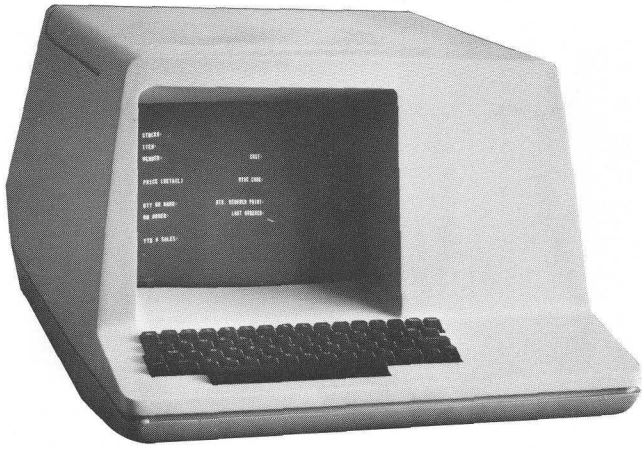

### VT50 DECSCOPE

Following the successful entrance of the LA36 DECwriter II into the highly competitive terminals market, DIGITAL introduced in September a new video display terminal—the VT50 DECscope. A microprocessor-driven, alpha-numeric display terminal competitively priced with standard 10-character-per-second mechanical teletypewriter devices, the VT50, a soft-copy device, includes such features as three-key rollover, audible/tactile feedback, typewriter-like keyboard layout, up to 9600 baud transmission/reception rates, controllable display rates, and few mechanical parts. These features make it markedly faster, quieter, easier to use and maintain, and considerably more reliable than an electro-mechanical device, all for a price that puts it within the range of customers who presently can only use 30 char/sec. hard-copy devices.



### KL-10

The DECsystem-10 group announced in October two new systems, the 1080 and 1090, built around the new KL-10 central processor. Twice as fast as its predecessor, the KI-10, and four times as fast as the earlier KA-10, the KL-10 features 386 micro-programmed instructions, emitter coupled logic (a state-of-the-art technology), and a 125 nanosecond access time cache, or buffer memory. One of the more significant features of the KL-10 is the Console Diagnostic Computer, which uses a PDP-11/40 to perform those functions.

### TU70

Coupled with the announcement of the KL-10 was the release of information on the TU70 series. This series of high-speed magnetic tape drives represents the latest design in tape transport technology. The TU70 is a 200 inch/second, 9-track transport with program selectable recording density of 800 and 1600 characters/inch. The TU71 is a 200 inch/second, 7-track transport with program selectable recording densities of 200, 556 and 800 characters/inch.

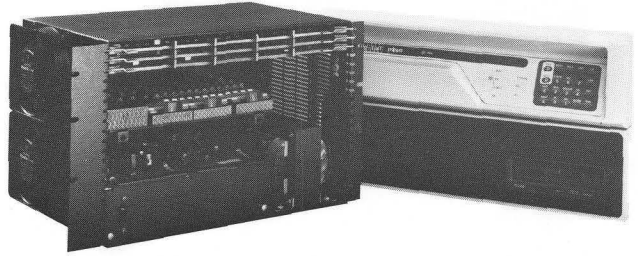

### 8/A-200, 400

Two new members of the PDP-8/A family were added in December, extending its line to the full range of memory configurations.

Available with almost all standard PDP-8 options and peripherals, the 8/A-200 consists of the present PDP-8/A single board central processor, a new 4K semiconductor chip RAM memory, power supply, battery backup, an operator's console, chassis, and 12 slot OMNIBUS. The new semi-conductor memory utilizes a new 4K MOS (RAM) chip, mounted on a hex size board, providing a more reliable and less costly 4K memory package than either core or previous semiconductor memories. The one hour memory-refresh battery back-up is provided as a standard feature, since semiconductor memory is volatile.

The PDP-8/A-400 is the same basic configuration as the 8/A-200, using the same single-board processor, but offers two new single-board core memories. The new memories which plug into only 1 OMNIBUS slot, are available in both 8K and 16K configurations, allowing the 8/A-400 to accommodate up to 32K of main memory. With DIGITAL's high volume production and new packaging techniques, this product offering is available at the lowest price in the industry.

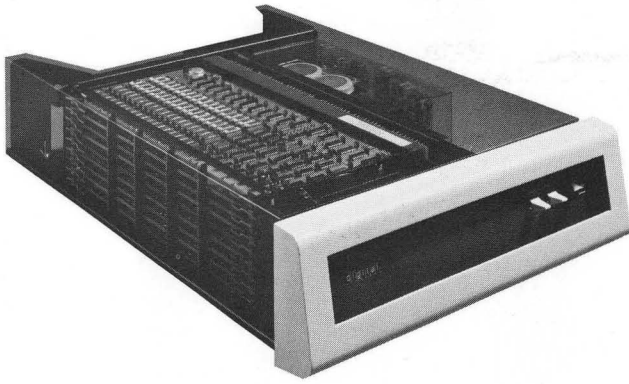

### **PDP-11/04**

A new, low-cost, third-generation member of the PDP-11 family, designed specifically for OEM's, was released in December. The PDP-11/04, completely software and UNIBUS compatible with the 11 Family, unbundled some of the standard features of the PDP-11/05, enabling it to be offered as a low-end price leader. Featuring the CPU on single hex module and either a 4K or 8K MOS memory on a single hex-size module, the 11/04 is completely program compatible with the 11/05, providing all the 11/05's processing capability at significantly higher speed.

### **TU45**

The Computer Special Systems Group expanded the Corporation's magnetic tape offerings in February with the introduction of a 75 ips tape transport, the TU45. Software

compatible with the TU16, the new tape system was designed to fulfill the needs of users requiring higher tape throughput on a PDP-11-based system.

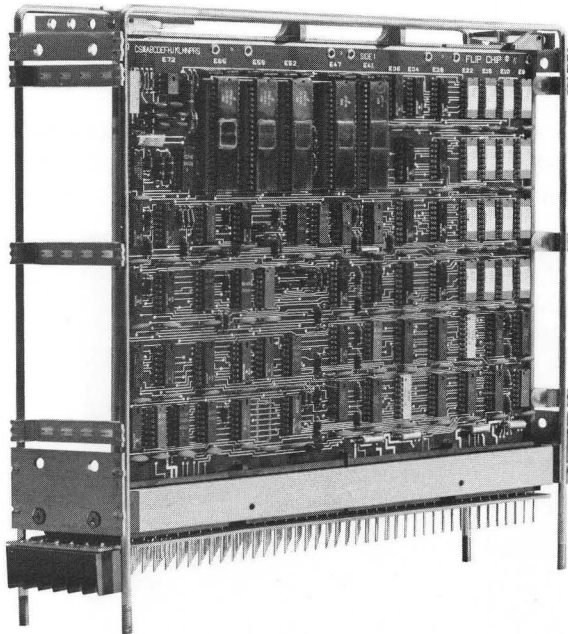

### **LSI-11**

Large Scale Integration (LSI) technology has made possible the achievement of high performance and reliability in smaller packages and at lower costs. The LSI-11, announced in February, takes advantage of these factors by using this technology to provide true minicomputer performance in microcomputer packaging and at micro-computer pricing.

Directed towards OEM's and large volume end-users whose applications require the computer to be buried inside the final applications product, the LSI-11 is applications oriented in that it is a complete computing system (CPU, Memory and I/O) on one board. Yet, as a member of the PDP-11 family, it offers potential users the benefit of DIGITAL's years of experience with installed PDP-11's, plus libraries of software, documentation and training aids.

The LSI-11 Family of products consists of a micro-computer module, four expansion memory modules (ROM, PROM, RAM and CORE), two I/O interface modules (serial and parallel), and a back-plane/card guide assembly, giving users the flexibility to buy the absolute minimal system and expand it to meet the application's requirements.



### PDP-11/70

Another major product announced in February was the PDP-11/70, "big brother" to the PDP-11/45 that pioneered the medium-scale systems marketplace and established DIGITAL as its leader. The newest price/performance leader in the medium-scale computer marketplace, the PDP-11/70, representing the high end of the PDP-11 architecture with the capacity for supporting the speed, addressing range and bandwidth required in large systems applications. In particular, the 11/70 offers performance-conscious PDP-11/45 users in a medium systems environment a growth path for long-range, higher throughput requirements.

By providing extensions to RSX-11D and RSTS/E to take advantage of the power of the 11/70, software also plays a major role in the new system.

### ICS, ICR

In March, the Industrial Products Group introduced new Process Control I/O interface hardware. The Industrial Control Subsystem (ICS) is available for both PDP-8's and 11's; the Industrial Control Subsystem Remote (ICR) is available for PDP-11's.

The ICS offers many significant advantages over the UDC, which it replaces: to mention a few, the functional I/O modules and signal conditioning are combined onto one hex-size module, and it contains its own power supply.

The ICR, a variation of the ICS, can be located remotely from a PDP-11 for distances up to 6000 feet. The ICR represents state-of-the-art technology for remotely locating process I/O interface hardware. A full complement of functional I/O modules is available for the ICS and ICR, including DC and AC voltage sense and interrupt, I/O counters, DC and AC outputs D/A and A/D converters.

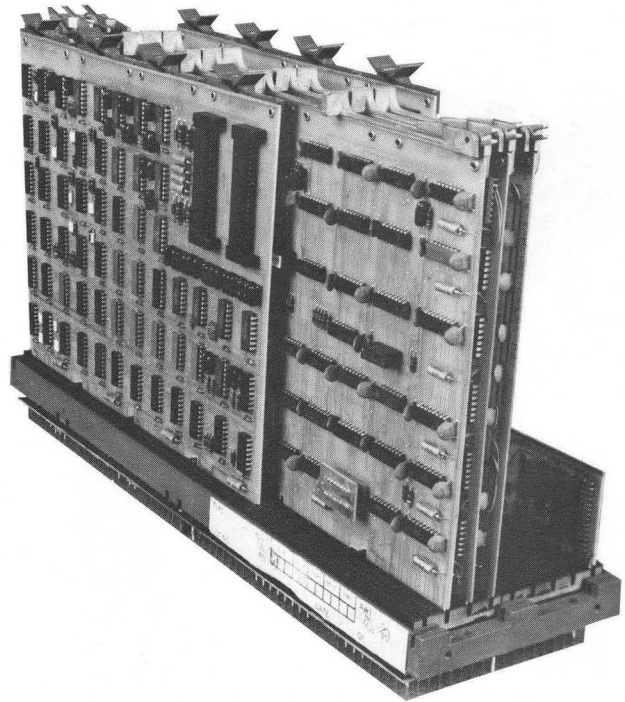

### NEW SYNCHRONOUS MULTIPLEXER: DV11

A new, competitively-priced, high-performance synchronous multiplexer that connects the PDP-11 to up to 16 lines was announced in March. Designed to relieve the PDP-11 system of much of the load involved in interrupt handling, special character processing and CRC/LRC calculations, and because it performs most of the protocol processing needed to support multiple synchronous lines, and is therefore more than simply an "interface", the DV11 is a true communications preprocessor.

Major applications are in the areas of a PDP-11 communicating with several other computers or a PDP-11 communicating with several buffered terminals.

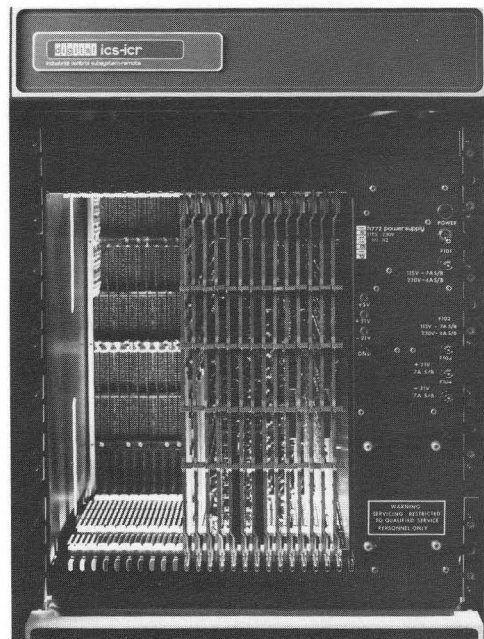

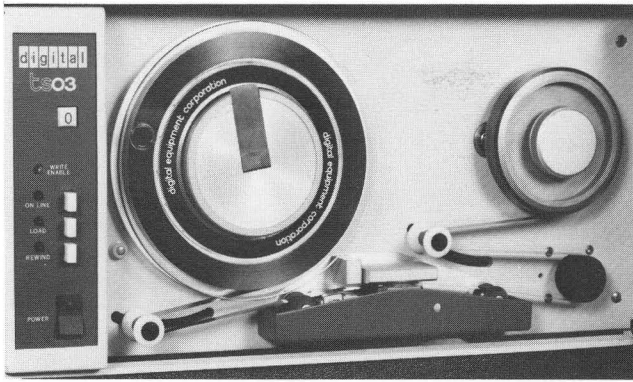

### TS03

A further extension to the Corporation's magtape product family was announced in April. The TS03, a 12.5 ips, 800 bpi, tension arm magnetic tape subsystem using 7" reels, offers a highly reliable magtape subsystem suited to the needs of customers requiring economy systems. Other significant features include its small physical size, low power consumption, and silent operation.

The low cost of the TS03 makes it attractive for data logging, interchange, bulk storage, and RK05 fail-safe applications in small systems. Since software is distributed on 7" tape reels, the TS03 can also be used for inputting operating system software to the system. In cases where only a small portion of a 10½" reel will be used and a high transfer rate is not needed, the TS03, priced below the TU10, provides an alternative for economy-minded users.

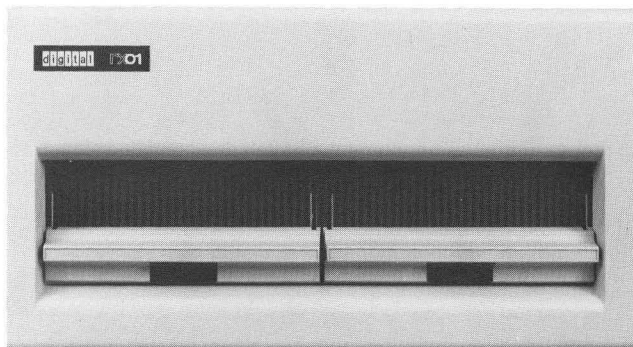

### RX01

The RX01 Floppy Disk system, using a "diskette" or "floppy" medium, was introduced in May. A highly-reliable, random access, low-cost mass storage device for data interchange and software distribution on PDP-8 and PDP-11 systems, the RX01 is capable of storing up to 256K eight-bit bytes per drive in an IBM-compatible format. It can be used in the same applications as a TU56 DECtape or a TU60 DECcassette, but has better cost/performance and uses an industry-compatible medium.

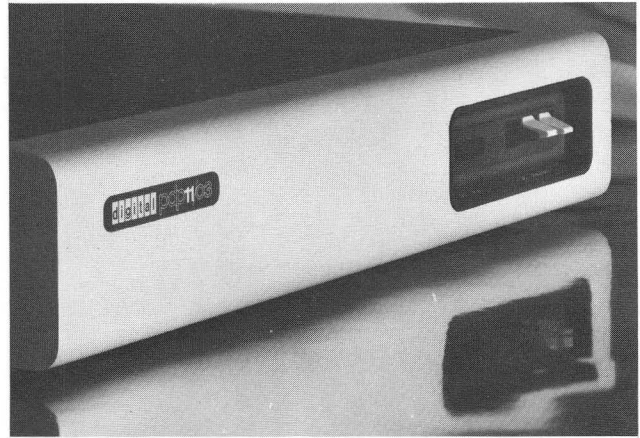

### PDP-11/03

In response to the interest generated by the introduction of the LSI-11, the Components Group announced in June a packaged version called the PDP-11/03. Positioned between the LSI-11 and the PDP-11/04, The PDP-11/03 is aimed at those users who require an entire/complete computing system (power supply, fans, enclosure, operator's panel, etc.) from which to begin their own development, providing cost-effective solutions for applications requiring a systems tool product.



### VT55

The VT55, a new plotting graphic display in a terminal, introduced in June by the Lab Data Products group, represented a major design achievement. Designed for applications in which users perform data analysis and display, as well as interact with the system via a keyboard, the VT55 offers significant cost advantages over conventional approaches by combining the operation of a CRT data display with that of the system console terminal. In addition, the text and data are stored in the VT55, freeing computer memory and relieving the CPU of the workload of image display since the VT55 uses its own memory and refreshes the screen from it via hardware techniques.

**RTS-8**

RTS-8, a real-time, multi-programming development system for the PDP-8 family, was announced in July. Designed to control the execution of tasks previously built on the popular OS/8 operating system, RTS-8 features an executive that occupies less than 700 words of core and controls up to 63 fixed-priority tasks and runs on any PDP-8 processor (except 8/S) in any configuration. Particularly in combination with the 8/A, RTS-8 provides minicomputer performance at microprocessor prices.

**IAS**

A major new multi-function operating system was introduced concurrent with the PDP-11/70. The Interactive Application System (IAS) provides users multi-function (time-sharing/batch/real-time) and multi-language (FORTRAN/BASIC/COBOL/MACRO) capabilities.

The system emphasizes protection and ease of use for the non-technical user via the new Corporate standard command language. The real-time capabilities are the same as those in RSX-11D, and the system is file-and-task-compatible with it.

**FORTRAN IV-PLUS**

FORTRAN IV-PLUS, an optimized, in-line FORTRAN compiler, was also announced in July. Requiring a minimum task area of 16K words main memory, this compiler was designed to run under the RSX-11D operating system on a PDP-11/45 equipped with a floating point processor unit, thus making the speed and power of the PDP-11 architecture available to higher-level programmers. It was released later in the year under the newer RSX-11M operating system, lowering its entry-point into the PDP-11 Family and enhancing its competitive stance in the medium system market.

**PDP-11 COBOL**

Another significant software announcement was made in October with the release of PDP-11 COBOL, the first ANSI-74 COBOL compiler on the market. Run under the RSX-11D operating system, PDP-11 COBOL is designed to provide fast, direct access processing for commercial applications, leading to reduced cost, better use of computer resources, and minimized human error. The disk-resident compiler not only accepts source program input from cards, consoles and disks, but has the ability to accept source text from library files. Compilation and execution of COBOL programs by the PDP-11 systems are characterized by a high throughput rate and efficient memory utilization.

## DECNET

With the announcement of DECNET in mid-April at DECUS, DIGITAL expanded its communications software offering to support most major operating systems, including RSX-11D, RSX-11M, RSX-11S, RSTS/E, RT-11, IAS, RTS-8, and TOPS-10.

DECNET, DIGITAL's name for integrated computer-to-computer communications capability, allows PDP-8's, PDP-11's and DECsystem-10's to be integrated into a network based on each system's unique capabilities.

Unlike competitors' networks offerings, DECNET is not a terminal network, but is a true computer-to-computer capability for distributed computing systems.

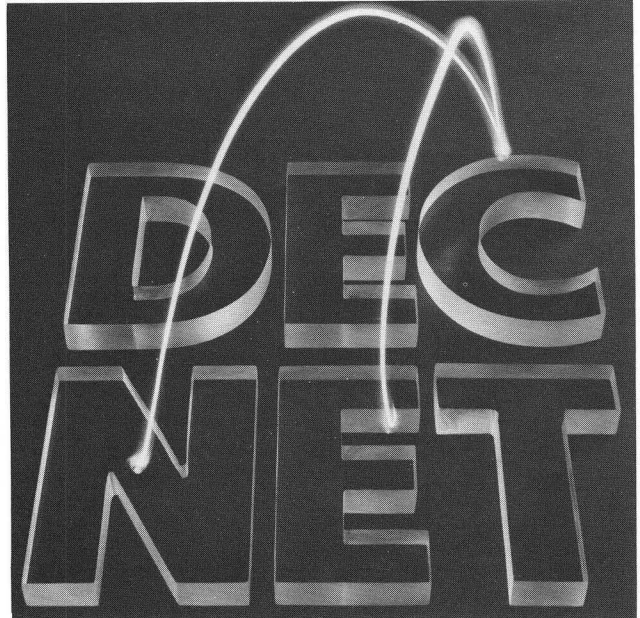

---

## SYSTEMS

1975



### DATASYSTEM 535

In September, the Business Products Group expanded the range of its product offering with the introduction of the small, low-cost, DEC DATASYSTEM 535, a small 11/40-based system that supports up to four terminals and eight RK05 cartridge disks.

### DECCOMM 600

DIGITAL's experience with real-time operating systems, such as RSX-11D, and medium-sized time-sharing systems, such as RSTS/E, indicated the existence of a substantial need for systems that could provide optimum performance in transaction-oriented applications where data communications are a major requirement.

In response to this need, DIGITAL added TC/D to RSX-11D to create a complete transaction processing system called DECCOMM 600 for use by users with communications-intense, transaction processing applications.



## PDP-8/A BASED SYSTEMS

The development of the PDP-8/A paved the way for DIGITAL's introduction to minicomputer-based systems into the highly competitive small business computer market, and programmable calculator market.



In response to the growing demand by users for small, low-cost computer systems, the Business Products, Education Products, and Engineering Computation Products announced the first in a series of a new PDP-8/A based products, the DIGITAL minisystems, for their respective marketplaces.

By integrating a set of components into a single entity, attractively packaged in an integrated desk, the DEC DATASYSTEM 310, the CLASSIC, and the CMS/1 offer easy-to-operate, highly reliable, low-cost systems capable of running high-level languages and providing on-line storage. These systems provide one hundred times the power of a programmable calculator at one-half to one-third the cost and ten times the power of an accounting machine at one-half its price.

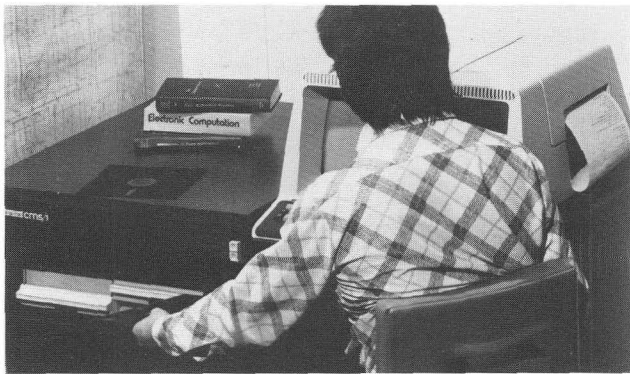

## CMS/1

The CMS/1, first in the new series of computational mini-computer systems designed for engineering firms and computational applications needing multiple, dedicated, low-cost, FORTRAN-IV-oriented systems, has the same basic configuration as CLASSIC, less the copier. CMS/1 provides both extension kits for OS/8 (FORTRAN-IV, BATCH BASIC, TECO) as standard features. Options include printers, communications interfaces, and additional diskette and memory devices.



## DEC DATASYSTEM 310

The DEC DATASYSTEM 310 was designed to be sold by the dozens to large corporations and through Business Products OEM's to the small business in need of a small accounting machine.

For the small business, the DS310 becomes a low-cost solution to accounting problems by automatically performing many business functions that are performed manually.

For the large corporation, the DS310 can be used in a distributed data processing environment.

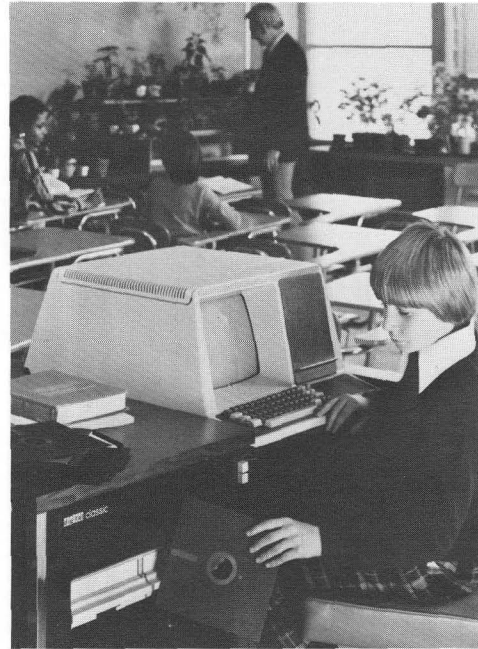

## CLASSIC

The Classroom Interactive Computer provides educational institutions, particularly secondary schools, with a classroom tool they formerly could not afford. The CLASSIC package comprises a complete system (16K word PDP-8/A, dual floppy disk, VT50 DECscope and electronic copier, and standard OS/8) that includes application and curriculum packages consisting of documentation and ready-to-run programs.



### **PDL**

Another low-cost system, based on the DECLAB 11/10B, was introduced in February by the Lab Data Products Group.

The Programmable Data Logger (PDL), developed for use in hospital and independent clinical laboratories, is designed to collect, record and calculate data from up to 15 laboratory instruments and includes specially designed interfaces that allow the computer to be directly connected to clinical lab instruments.

PDL offers lab users the benefits of computer power and efficiency, together with the simplicity and convenience of a calculator at calculator prices.

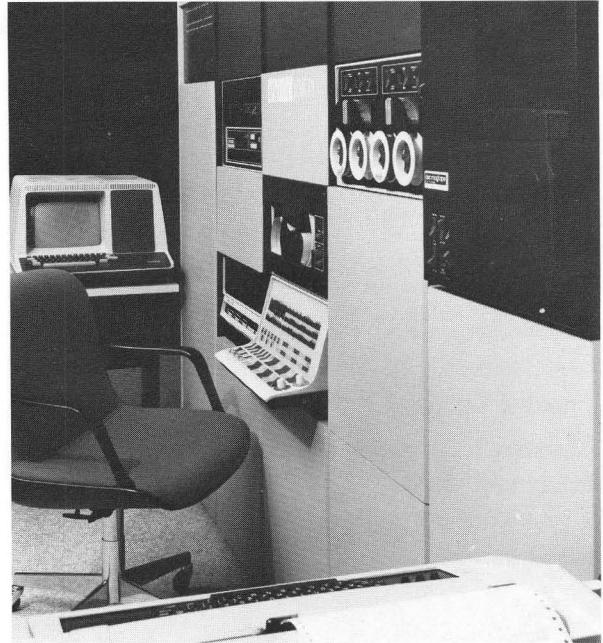

### **XVM SYSTEMS**

XVM Systems, the newest extensions to the PDP-15 family, were announced in April. Both a stand-alone system and an option for already installed PDP-15's, XVM offers program size up to 128,000 words and, compared to former PDP-15 configurations, up to 30% faster execution speed and up to 18% reduction in prices. The two basic XVM systems available are XVM-100 (single-processor) and XVM-200 (dual processor). For both arrangements, the nucleus of improved performance is the XVM memory processor, a unit that furnishes instruction lookahead and sophisticated memory management. New operating systems supported by XVM are XVM/RMX, XVM/RSX, XVM/DOS, and XVM/MUMPS. Intended to markedly enhance 18-bit capability in the computer-aided design field with multi-terminal graphics systems for general-purpose use, or for applications in architectural design, electronic circuit layout, factory layout, and cartography, the XVM series maintains full upward compatibility with current PDP-15 hardware and software.



### **INDUSTRIAL 850 AND 840 SERIES**

The price/performance of the PDP-8A and its new peripherals permitted the implementation of computers for industrial applications which previously could not be justified. In response to this new opportunity, the Industrial Products Group announced its new 850 and 840 series of Standard Industrial Systems in May.

These new offerings combine the PDP-8A, 8A options, Floppy Disk, the IDC and a new release of OS8/Industrial BASIC Software to provide Industrial tools at prices previously not possible.



## FINANCIAL SUMMARY

<b>FISCAL YEAR</b>	<b>1975</b>
Total Operating Revenues	\$531,774,000
Income Before Income Taxes	73,600,000
U.S. & Foreign Income Taxes	27,600,000
Net Income	46,000,000
Total Assets	565,069,000
Current Assets	412,160,000
Current Liabilities	78,958,000
Stockholders Equity	394,385,000
No. of Shares Outstanding at Year End	36,066,000
Net Income Per Share	\$1.28
EMPLOYEES AT YEAR END	19,000
SHAREHOLDERS AT YEAR END	15,033

## GENERAL

MILESTONES/FISCAL 1976

## HARDWARE

4K BIPOLAR MEMORY (MS11-AP)  
FOR THE PDP-11/45-11/50  
11T40  
THE PDP-8/A-800 SERIES  
LA180  
VT55 HARD COPY UNIT  
VT52  
RK05J  
MPS PROGRAM  
11V03  
NEW LA35 AND LA36  
DMC11 NETWORK LINK  
DUP11  
FPP-11C FLOATING POINT UNIT  
FOR THE 11/70  
PDP-11F10  
TU45 TAPE SYSTEM  
11T55  
THE PDP-8/A 600 SERIES  
PDP-11F34  
GT43  
RP05 AND RP06 DISK DRIVES  
THE VT71/T TERMINAL  
RK05F DISK DRIVE

## SOFTWARE

RSX-11M/2780  
FORTRAN/RSTS-E  
NEW VERSION OF  
EDUSYSTEM 20, 25  
EDUSYSTEM 50 (TSS/8)  
FOCAL UNDER RT-11  
ASSIST-11 DIRECTORY  
ASSISTANCE SYSTEM  
COS 310/2780 EMULATION  
FOR DS 310  
RT-11/2780  
PDL/RT-11  
CPL FOR DECSYSTEM-10 AND  
DECSYSTEM-20  
REMOTE-11  
CTS-500/E DATA MANAGEMENT  
SERVICES 500  
FOCAL/MPS  
PDP-15/XVM  
BASIC-11 IAS/RSX VERSION 2.0  
RPG II  
INDUSTRIAL BASIC/RT-11  
IAS V1.1  
RMS-11/DBMS-11

## SYSTEMS

DATASYSTEM 350 SERIES OF  
SMALL BUSINESS TIME SHARING  
SYSTEMS  
11T35  
POWER MANAGEMENT SYSTEMS  
VS60, GT62 HIGH PERFORMANCE  
GRAPHICS  
THE SYSTEM 800  
DEC DATASYSTEM 535-E  
MU/11V03  
GT-46 STANDALONE GRAPHIC  
SYSTEM  
PDP-11/34 SYSTEMS  
PDP-11 FORTRAN SYSTEMS  
DECEDIT  
DECSYSTEM-20  
DS350 11/34 PACKAGED SYSTEMS  
DATASYSTEM 534 PACKAGED  
SYSTEMS  
DEC DATASYSTEM 530  
DECSYSTEM 1088 AND  
DECSYSTEM DUAL 1080  
DEC DATASYSTEM 570  
WORD PROCESSING 310W

## FINANCIAL SUMMARY

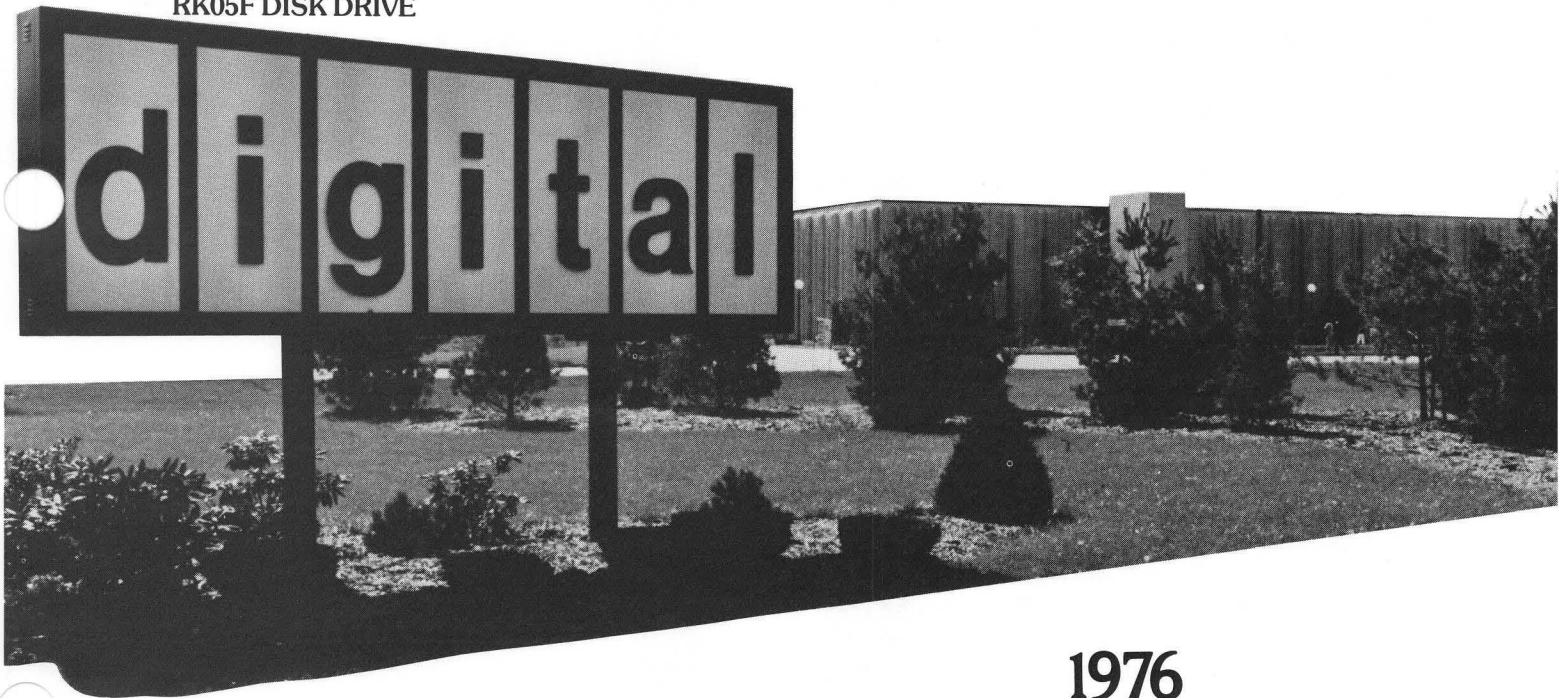

**1976**

7/75-6/76

## MILESTONES/FISCAL 1976

**JULY, 1975**

*Customer Spares product line is formed.*

**SEPTEMBER, 1975**

*50,000th computer system, a PDP-11/50, is delivered.*

**DECEMBER, 1975**

*Plans are announced to build plants in Ayr, Scotland, and Salem, New Hampshire.*

**JANUARY, 1976**

*Introduction of the DECSYSTEM-20, lowest-priced, general-purpose timesharing system on the market.*

**MARCH, 1976**

*Space is leased in Acton, Massachusetts, and Nashua, New Hampshire.*

**JUNE, 1976**

*Colorado Springs is chosen as a plant site.*

## HARDWARE

1976

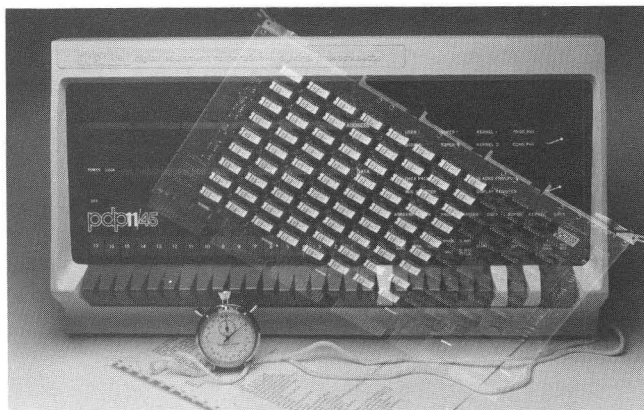

**4K BIPOLAR PARITY MEMORY  
(MS11-AP) FOR THE  
PDP-11/45-11/50**

In July, a fast (300 to 330 nsec.) solid-state parity memory up to a total of 32K per CPU was offered for the PDP-11/45 or 11/50. This memory significantly boosted the performance of the PDP-11/45 and 11/50.

**The PDP-8/A-800 Series**

*The PDP-8/A800 is a PDP-8/A designed for customers who need fast FORTRAN IV and floating point with extended precision arithmetic at a low cost. The FPP 8/A processor itself is on two hex modules and plugs directly into the 8/A OMNIBUS. The 8/A800 brings the computational power of much larger and more expensive systems to the user with a limited budget.*

**11T40**

In August, a new standard in disk-based systems was announced, the 11T40. The 11T40 is an extremely attractive system which can be used as a complete system by adding RT-11 or RSX-11M and is an exciting starter system for RSTS/E and RSX-11D.

*The PDP-8/A-820 is a twenty slot version of the 8/A800 system consisting of the 8/A420 and the FPP-8/A floating point processor. The PDP-8/A420 twenty-slot version of the 8/A400 computer was introduced to meet customer requirements for additional slots and power.*



### LA180

In September, the LA180 DECprinter I was offered by the Corporation. The LA180 is a receive-only printer capable of printing at the rate of 180 characters per second. The machine is an expansion of the family of printing devices based on the LA36 mechanism. The LA180 is a parallel interfaced machine capable of driving up to one hundred feet of cable. Standard features include electronic Head of Form, paper out switch, six part forms, 132 columns, upper/lower case printing, paper out override, and self test mode.

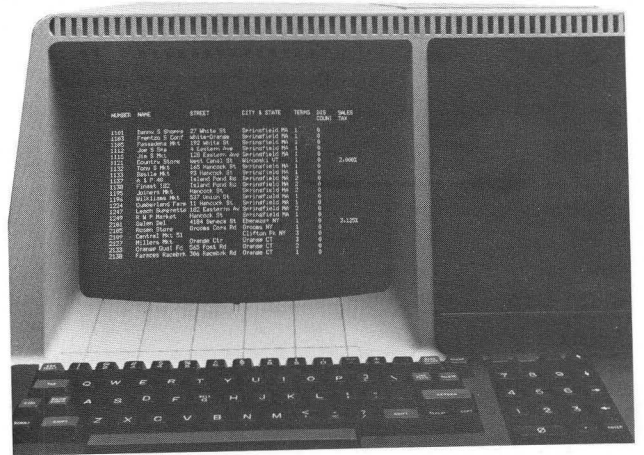

### VT52

As an addition to the VT50 family, the VT52 was designed to sell into programming, time sharing, and text editing applications. The VT52 has more performance than a VT05 and is an enhanced version of the VT50. In addition, the 19-key cluster pad on the VT52 provides numeric keys for data entry in Business, Financial, or Industrial applications.

There are four cursor control keys and three unlabeled function keys. These seven keys transmit escape sequences which can be used by the customer as special function keys. In addition, software can place the terminal in a mode in which each key on the keypad transmits a unique escape sequence. This allows the customer to define all 19 keys for a particular application.



### VT55 HARD COPY UNIT

The VT55 is an on-line interactive CRT Terminal that offers waveform graphics, complete alphanumeric and hardcopy output. The user can obtain a hardcopy reproduction of the display screen for both characters and graphs.



### RK05J

In September, a milestone was reached in DIGITAL's highly successful program to significantly improve the reliability of RK05 disk drives with the designation of RK05J. This dramatic improvement in reliability and read/write performance of the RK05 resulted in a decision to redesignate this new product as the RK05J. The RK05J is the result of significant changes in the engineering design, tighter incoming inspection, improved assembly techniques, rigid quality control, and exhaustive testing prior to customer shipment.

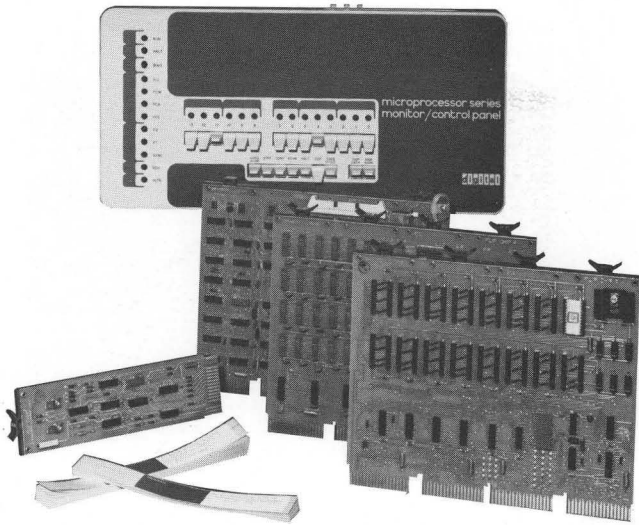

### MPS PROGRAM

The MPS Microprocessor Series modules have been designed to supply users with a reliable, low-cost microprocessor which can be used in process/control systems, as well as in data formatting or preprocessing applications. The MPS modules make up a very flexible microprocessor system which is part of the Logic Products family of modules. Logic Products' interfacing modules complement the MPS system. These modules, standard products available in single or large quantities, allow low-cost interfacing of MPS to almost any electrical device.



### 11V03

The PDP-11V03 was the first complete system available from DIGITAL that is based on the LSI-11 processor and option series. The 11V03 is a roll-around RT-11 system.



### NEW LA35 AND LA36

In November, new option-expandable models of LA35 and LA36 DECwriter II were offered for sale by the Corporation. Also offered was an extensive list of options

which increased forms handling and communications capabilities. This product has since become DIGITAL's most successful product.

### DMC11 NETWORK LINK

In November, the DMC11 Network Link was announced. The DMC11 Network Link is designed for high performance inter-connection of PDP-11 computers in network applications. The DMC11 substantially enhances the performance of DECNET and is supported in all PDP-11 DECNET systems. It also is to be supported in the RSX-11M system, independent of DECNET.

The DMC11 offers a number of advantages over conventional interfaces which require a combination of hardware and software to implement a protocol. Programming is greatly simplified. Programming the DMC11 does not require extensive communications expertise. PDP-11 memory and processor time are not wasted with instructions implementing the protocol. Throughput is enhanced, because the DMC11 microprocessor operates at high speed and is not delayed when the processor has to perform high priority tasks.

### FPP-11C FLOATING POINT UNIT FOR THE 11/70

In November, a new performance option for the PDP-11/70 was announced. The FP11-C is a high performance floating point option that is twice as fast as the Floating Point Unit that was currently available, FP11-B. The FP11-C represented the latest step toward total system performance.



### PDP-11F10

In November, a newly configured standard system was made available—the PDP-11F10. It offers the advantage of a single order number for all hardware comprising the system, assuring a complete and functioning configuration.

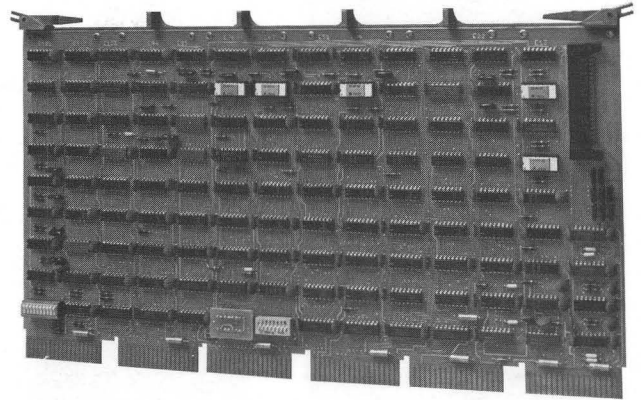

### DUP11

In November, the DUP11 single-line, synchronous interface was announced. The DUP11 is similar to the DU11 but with several new capabilities. The most important of these is the ability to operate with the new IBM SDLC protocol and other similar new bit-oriented protocols such as HDLC, ADCCP and X.25. The DUP11 also offers enhanced operation with our DDCMP protocol. The DUP11 is our first product with the SDLC capability and shows our commitment to continued communications with IBM. The DUP11 can also be used for DECNET communications using the DDCMP protocol.



### TU45 TAPE SYSTEM

The TU45 enabled DIGITAL because of its speed and reliability to sell large systems which could not be satisfied with lower speed units. Typical applications include disk back-up, tape interchange and archival storage.



### 11T55

In December, the PDP-11T55 was announced. It is a disk-based system which at the time it was announced provided the industry's fastest system performance for FORTRAN "number crunching" computational and control applications. Major components of the 11T55 include the 11T55 processor with either 16K or 32K words of bipolar memory. CPU instruction execution and memory cycle time are both 300 nanoseconds. It has a new and exceptionally fast floating point processor, the FP11-C, doubling the performance of the FP11-B. Two RK05 DECPACK moving-head disk drives—2.4 Byte capacity per drive.

The 11T55 is a redesigned 11/45 processor with some 11/70 features, 32K parity bipolar memory and the capability of accepting the FP11-C floating point unit. When memory management is off, this combination—bipolar memory and FP11-C—results in the fastest PDP-11 computer ever made up to this time. The 11/55 outperforms all PDP-11s in FORTRAN "number crunching" applications.

### THE PDP-8/A 600 SERIES

*In April, the "fast" PDP-8/A 600 Series was announced as a replacement for the PDP-8/E, 8/F, and 8/M. The "fast" 8/A has the following features: efficient packaging, 8/E Speed-1.2  $\mu$ sec., utilizes 8/A Core Memories, less expensive than 8/E's and 8/M's, expansion capability beyond basic box, hardware multiply/divide available as an option, 12 slot and 20 slot OMNIBUS models.*



### PDP-11F34

The PDP-11F34 is a standard system featuring an 11/34 processor with 16K words of memory, memory management, bootstrap and line clock, dual-drive RX11-B subsystem, and LA36 terminal and control. It supplies greater functionality than the PDP-11F05/10.



### GT43

The GT43 is a graphic display terminal combining the power and performance of the 11/34-DM processor and the interactive graphics of the VT11 graphics display subsystem. The GT43 is designed for graphic terminal work in conjunction with a host computer, but with the features of the 11/34-DM, the GT43 can easily be expanded into a stand-alone configuration.



### RP05 and RP06 DISK DRIVES

In May, DIGITAL widened its lead in the minicomputer market with two new members of the RP family. The RP05 is a 100 million byte drive that can be field upgraded to the double capacity RP06 unit. The RP05 and RP06 have the same high level of performance and broad range of features as the RP04. The two utilize the same RP04 controllers, and all three disk drives can be intermixed on a single PDP-11 controller.

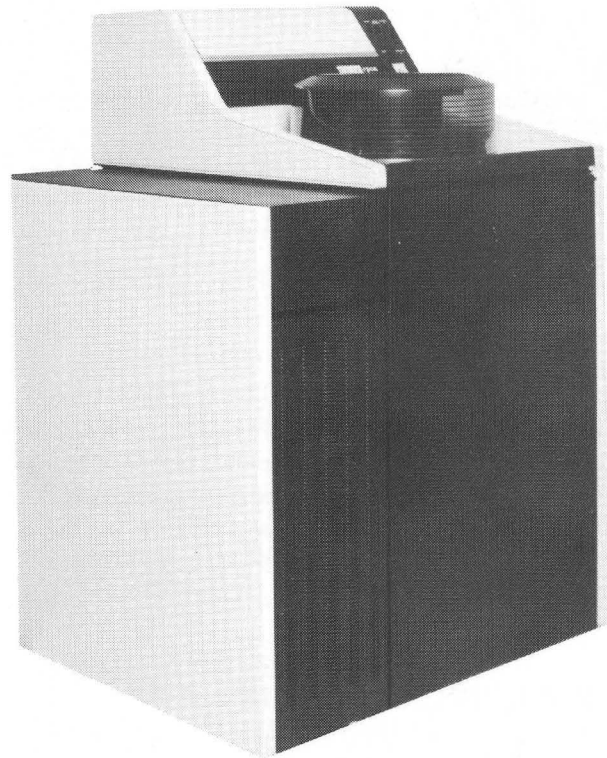

### RK05F DISK DRIVE

The introduction of the double capacity RK05F significantly increased the competitiveness of DIGITAL's entry level disk products which are key options for the PDP-8 and PDP-11 computer systems. The RK05F is essentially identical to the RK05J except that it has twice the track density and a non-removable media. Formatted capacity on the PDP-11 is 5.0 million bytes; on the PDP-8, the formatted capacity is 6.64 million bytes.

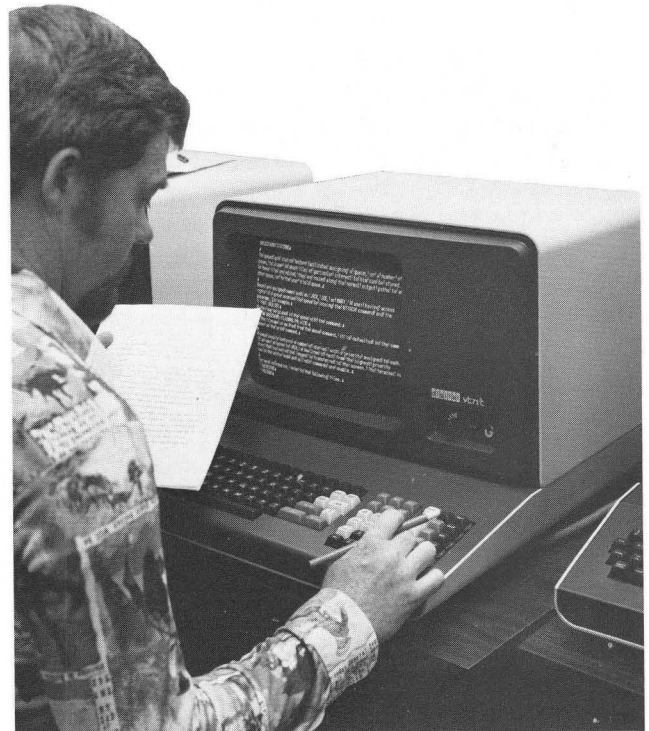

### THE VT71/T TERMINAL

The VT71/T is a desk top, LSI-11 based video display terminal with a 15" diagonal, non-glare screen capable of displaying up to 24 lines of 80 characters. The keyboard offers standard typewriter layout plus two color-coded, 18-key function pads to the right of the keyboard for text editing and copy management functions. A row of 16 keys designed for user-designed, single or multiple function execution, is located above the typewriter layout.



**RSX-11M/2780**

The release of RSX-11M/2780 nearly completed the PDP-11 family of 2780 products and provided computer-to-computer communications for the PDP-11, PDP-8, and DECsystem-10. The RSX-11M/2780 can transfer files over synchronous data links to and from the above mentioned systems.

**FORTRAN/RSTS-E**

In October, FORTRAN/RSTS-E was announced. It is an extended, optimizing FORTRAN IV system which operates in interactive or batch mode under the RSTS/E executive. FORTRAN/RSTS-E is a compatible member of the PDP-11 FORTRAN IV family which is available on the RT-11, RSX-11M, RSX-11D, and IAS operating systems for the PDP-11.

**NEW VERSION OF EDUSYSTEM 20, 25**

New versions of EDUSYSTEM 20 and 25 software were developed, tested, and submitted for distribution.

**EDUSYSTEM 50 (TSS/8)**

The Education Products Group announced the final release of V8.24 of the EDUSYSTEM 50 (TSS/8) Time-sharing Monitor. New device handlers were added for CR8/F(CM8/F) and RK8E hardware. A new program was written to perform data transfers between all TSS/8 devices in many different formats including OS/8 DEC-tapes which may be read and written in reverse and forward directions.

**FOCAL UNDER RT-11**

FOCAL-11 (FOrmula CALculator) is a powerful, interactive, high-level programming language designed for scientists who require an easy-to-learn-and-use, Real-Time language. FOCAL provides both data acquisition and experiment control, as well as data analysis capabilities. FOCAL utilizes the extensive resources of RT-11 for program and data storage. Both Chaining and Overlay capabilities allow the user to write very large programs. FOCAL/RT-11 will operate with a minimum of 12K memory (16K recommended).

**ASSIST-11 DIRECTORY ASSISTANCE SYSTEM**

ASSIST-11 is a Directory Assistance System designed to provide operators with computerized access to as many as twenty million subscriber listings without referring to printed directories and addenda. Requests for directory information are entered by the operator on a CRT display

with a response occurring in seconds with matching entries in telephone directory format.

ASSIST-11 is an application program based on a PDP-11 running RSTS/E which supports a number of operator stations equipped with VT52 displays. It includes all necessary facilities for simultaneous inquiries and maintenance of the directory data base.

**COS 310/2780 EMULATION FOR DS 310**

In November, COS 310/2780 RDCP software was announced. The software product which is offered on the Datasystem 310 permits batch communications to an IBM 360 or 370 Host system over print or dial-up communication facilities. With this capability the Datasystem(s) can be installed to meet the day-to-day application needs of the Corporation's remote location and communicate summary information to a central location to meet the needs of central control and reporting information. The package also permits communications between two Datasystems.

**RT-11/2780**

RT-11/2780 runs in background or foreground, but background operation requires that any foreground task be polite, getting out of the way often enough to allow the 2780 to process the protocol. Speeds are up to 4800 baud.

**PDL/RT-11**

The Medical Product Line announced that the Programmable Data Logger (PDL) will be offered under RT-11/MU BASIC. PDL is a hardware/software system that was designed to log data from 15 clinical instruments while simultaneously enabling the user to develop or run other application programs written in BASIC. PDL now does all this under RT-11 running on either dual floppies or dual disks.

**CPL FOR DECSYSTEM-10 AND DECSYSTEM-20**

CPL (Conversational Programming Language) is an interpreter which supports a subset of the ANS-1976 PL/I language. It features source-code debugging and immediate mode.

## **REMOTE-11**

REMOTE-11 (Real-time Multiprocessor Oriented Editor for PDP-11) is a software product that solves real-time laboratory problems through the use of computer networks. A REMOTE-11 configuration is a number of small satellites which are connected to a larger disk-based RT-11 host system.

## **CTS-500/E DATA MANAGEMENT SERVICES 500**

DMS provides BASIC-PLUS application programs with generalized data file management facilities for organizing and processing data stored in indexed file structures. By utilizing function calls in user level source language, application programs determine file access modes and input/output operations. Interfaces to the RSTS/E file System, direct access device input/output, and program data buffering are controlled by DMS-500 software.

## **FOCAL/MPS**

In April, came the announcement that FOCAL was now available on the MPS microprocessor. FOCAL programs can now be run on a wide variety of Digital machines, from the low-cost MPS to the PDP-8, PDP-11, and PDP-15.

## **PDP-15/XVM**

In April, the Large Computer Group announced a new product for PL15 Installed Base business:

### **MULTIACCESS ("MAX")**

a true multiuser version of XVM/RSX for either PDP-15 or XVM systems. Because it is based on XVM/RSX, Multiaccess provides a broad range of problem-solving capabilities in a single system, all usable at the same time: multiuser, on-line development/execution of FORTRAN/MACRO programs; multitask, real-time instrument data collection/control; and FORTRAN-supported, multi-station, GT15, high-performance, on-line batch.

## **BASIC-11 IAS/RSX VERSION 2.0**

BASIC-11 Version 2.0 is a conversational programming language which uses simple English-type statements and familiar mathematical notations to perform an operation. BASIC-11 Version 2.0 includes the following extensions to BASIC Version 1.0: more user-defined functions that return integer numeric values and that return a string value; virtual arrays will provide the facility to process arrays larger than available core storage; a call facility which provides the ability to call sub-routines from BASIC-11 programs; and Version 2.0 will include full integer support with integers being single words containing values in the range—32768 to 32767.

## **RPG II**

In May, the Business Products Group announced CTS-500/E RPG II. CTS-500/E RPG II has been developed for the System/3 Model 10 user who wishes to develop multiuser/interactive type applications in BASIC-PLUS.

## **INDUSTRIAL BASIC/RT-11**

Industrial BASIC/RT-11 consists of BASIC/RT-11 together with CALLable assembler routines for handling real-time events. Industrial BASIC/RT-11 provides extensive support for: one or more multiple (up to a maximum of 12) local Industrial Control Subsystems for the PDP-11 (ICS11) including analog inputs, analog outputs, sense and interrupt digital inputs, counter inputs, counter outputs, digital outputs, and one shot outputs; one or multiple AR11 real-time analog subsystems for the PDP-11 (up to a maximum of 12); one or multiple DR11-K general device interface subsystems for the PDP-11 (up to a maximum of 16); one or multiple DRS11/DSS11 digital I/O subsystems for the PDP-11 (up to a maximum combination of 16); Clock-driven functions to provide internal timing and utility for error handling, alarm notification and initialization. Either the ICS (Industrial Control Subsystem) or a combination of AR11, DR11K, DRS/DSS is supported as an I/O subsystem for a PDP-11.

## **IAS V1.1**

In June, IAS V1.1 was announced as a balanced system that delivers compute-power efficiently to interactive, batch, and real-time tasks in any mix, on demand, when and where it is needed.

## **RMS-11/DBMS-11**

In June, two new data services products, RMS-11 and DBMS-11, were announced. RMS-11 (Record Management Services) adds important capabilities at a level above that of traditional file management services. DBMS-11 (Data Base Management System) as a comprehensive CODASYL data base management system extends the upper range of DIGITAL's data services software offerings. It provides powerful and sophisticated data base management capabilities.



### DATASYSTEM 350 SERIES OF SMALL BUSINESS TIME SHARING SYSTEMS

In July, the Business Products Group announced the availability of timesharing to the user of small business computers. The Datasystem 350 Series is a family of upward compatible PDP-11/10 based systems which come in three basic configurations: a floppy disk-based system called the DS352, an RK05 based system called the

DS354, and an RPR02 based system called the DS356. The Datasystem 350 series, a combination of PDP-11 hardware and an operating system called COS-350, allows up to four users to simultaneously execute commercial programs written in the DIBOL-11 language.



### 11T35

In September, an exciting new standard in disk-based systems was announced—the 11T35.

### POWER MANAGEMENT SYSTEMS

In a move to help large users of electrical power to reduce costs, Digital's Power Management Systems were introduced to help decrease power bills by reducing both peak power demand requirements and total energy consumption. Early in the year the first Power Management application software product had been announced. That product was applied in a variety of market areas, including food processing, textiles, newspaper printing, and electrical equipment manufacturing. Customers experienced shorter paybacks than originally expected and purchased additional systems.

The Power Management applications software was updated to run on less expensive, memory-based systems. The software was combined with Standard Industrial Systems to form a series of Power Management Systems offering a variety of capabilities. The three systems are the Power Management 301, 501, and 701 Systems.

System/301—The 301 is a full power management system especially suited for applications where it is dedicated to Power Management activities.

System/501—The 501 includes all the functional features of the Power Management System/301 plus the extended capability to have user-written software tasks added or to have the applications software modified.

System/701 includes all the functional features of systems 301 and 501. As a higher level system, it allows more sophisticated user-written software to be added.



### VS60, GT62 HIGH PERFORMANCE GRAPHICS

In November 1975, Graphic Systems announced the VS60 and the GT62, two new high performance graphics display options. The VS60-AA(AB) is a UNIBUS peripheral which can be configured with any PDP-11; it executes



a superset of the VT11 instruction set. The GT62 is a terminal configuration based on the VS60 and a PDP-11/10. With the introduction of the 11/34, the GT62 received a CPU upgrade making the GT62 an even more powerful graphics terminal.

### THE SYSTEM 800

*As a result of greatly increased interest in desk mounted minisystems, the OEM group responded to requests for a similar product by announcing the MS800 series. To enhance the small system capability of this OEM offering, OS/8 operating system is included as standard. This package meets the needs of OEM customers who require an intelligent terminal for applications in such fields as security systems, inventory control, and laboratory analysis where the computer system must be styled and engineered for a commercial environment.*



### DEC DATASYSTEM 535-E

The Business Products Group announced a new, low cost, bundled DATASYSTEM 535 based on a low cost 11/40 system with two RK05's. The DS535-E is packaged in two short Datasystem cabinets and has three SPC slots and three SU expansion spaces.



### MU/11V03

In December, the Educational Products Group announced the MU/11V03. It is LSI-11, 4 user based system designed specifically for the classroom, at a price of less than \$5,000 per terminal. A choice of FORTRAN IV, BASIC, and APL programming languages are offered to meet the needs of all educational users. A graphics terminal with easy-to-use supporting software is available.



### GT-46 STANDALONE GRAPHIC SYSTEM

In February, Graphic Systems announced an upgraded version of the popular GT44 graphic display system. With the introduction of the 11/34 processor, the 11/34 was phased into the GT46 configuration, thus presenting the market with a more cost effective graphic system.



### PDP-11/34 SYSTEMS

In February, the PDP-11/34 was announced. It supplies computing power equivalent ( $\pm 10\%$ ) to that of the PDP-11/35 or PDP-11/40. New packaging densities, made possible by the use of a new series of back-panels, enables the 5¼" 11/34 CPU chassis to accommodate up to 64K words of MOS memory and the 10½" 11/34 CPU chassis to accommodate up to 128 words at MOS memory.

The PDP-11/34 is a standard system featuring an 11/34 processor with 32K words of memory, memory management, bootstrap and clock, a dual-drive RK11/RK05 subsystem, and LA36 terminal control.

### PDP-11 FORTRAN SYSTEMS

In March, announcement was made of the PDP-11 FORTRAN System Family, an idea which evolved out of the greater emphasis on FORTRAN throughout the mini-computer marketplace. Four optionally-configured system products were developed to compete in all segments of the marketplace.



- the 11V03 low entry system — our initial system offering with the best price/performance in the industry. It is optimized for single user FORTRAN IV with RT-11 Real-Time Foreground/Background System.



- the 11T55 — DIGITAL's fastest FORTRAN system. Its 32K bipolar memory, FP11-C floating point option and FORTRAN IV-PLUS will win all computational benchmarks requiring 32K words of memory. Program sizes larger than 32K require the 11/70 for optimum performance due to the 32K bipolar memory limit on the 11/55.



- the 11T34—maximum performance in the mid-range, and our low end offering with memory management and cartridge disk. This includes FORTRAN IV with RSX-11M for high performance multi-programming.



- the 11/70 with IAS—our top FORTRAN System performer for greater than 32K memory, high I/O bandwidth multimoded operating system, and FORTRAN IV-PLUS.

## DECEDIT

In April, the Graphic Arts Group announced DECedit, a system which offers the user up to 32 interactive text editing and input CRT terminals for story creation, editing, and data management. DECedit represents the fourth module of a line of PDP-8/E based products designed for news and text processing in the Graphic Arts marketplace. Each module is capable of standalone operations or interactive connection to other modules to form distributive processing networks. Other modules include the Graphic Arts' DECset-8000, DECwire-8000, and TABS-8 Systems.



## DECSYSTEM-20

The DECSYSTEM-2040 is a general purpose timesharing and batch system. The hardware is based on a non-cache KL20 CPU, 64-256K 36-bit words of core memory, 1-8 RP04 moving head disk drives, 1-8 TU45 tapes, a line printer (300 or 1200 LPM), a card reader (300 or 1200 CPM), and 8-64 terminal lines. The software is based on TOPS-20, a new virtual memory operating system designed for the DECSYSTEM-20. The TOPS-20 software supports concurrent interactive timesharing and multi-stream batch, with a variety of unbundled higher level language compilers and application tools available (FORTRAN, COBOL, BASIC, ALGOL, CPL, APL, and Data Base Management). Each higher level language has its own specific interactive debugger. The operating system provides a demand page user address space (256K 36-bit words) as well as many system calls to facilitate on-line data base applications and transaction processing applications. The DECSYSTEM-20 offers large scale general purpose system software to do efficient interactive timesharing and batch.

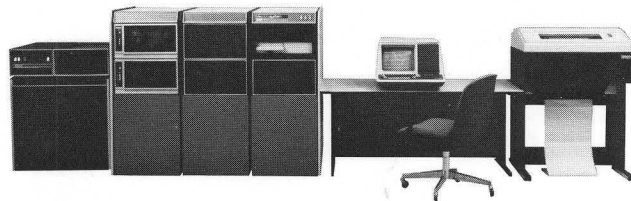

## DS350 11/34 PACKAGED SYSTEMS

In April, the PDP-11/34 was introduced into the DS350 family. This added significant configuration flexibility and expansion capability.

## DATASYSTEM 534 PACKAGED SYSTEMS

In April, Business Products announced its newest member to the DATASYSTEM 500 family—the DATASYSTEM 534. With equivalent computing power ( $\pm 10\%$ ) of the PDP-11/40, the DS534 will serve as a direct product replacement for the DS530, DS535, and DS540 DATASYSTEM models.



### DEC DATASYSTEM 530

The DEC DATASYSTEM 530 (D530) is a growth-oriented, business computer system for on-line transaction processing. Based on DIGITAL's field-proven PDP-11/34 central processor and the Commercial Transaction System—500 (CTS-500) operating software, the D530 is one of several compatible Datasystem family models offered by the Business Products Group, representing a mid-range capability. It is equipped to handle multiple-task applications in an interactive terminal user environment with background batch processing.

System highlights include large capacity memory, a wide selection of high performance peripherals, disk and magnetic tape mass storage subsystems, a comprehensive set of communications options, and a RSTS/E based commercial transaction operating system (CTS-500) which provides complete data/record management services, a full set of utility programs, and multiple language support.

Other operating systems which may be optionally implemented on the D530 are CDMS-500, DIGITAL's Commercial Data Management System; and RSX-11M, DIGITAL's Real-Time Operating System.

### DECSYSTEM 1088 AND DECSYSTEM DUAL 1080

*In May, the Business Products Group announced two new systems which were the most powerful ever manufactured by DIGITAL: the DECsystem-1088 and the DECsystem DUAL 1080. The DECsystem-1088 is a new high performance product extension of the DECsystem-1088.*

*The DUAL 1080 offers the capability of two complete, independent systems with the ability to switch key subsystems into a single configuration in the event of component failure.*

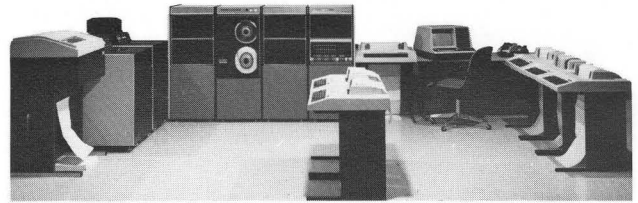

### DEC DATASYSTEM 570

The DEC DATASYSTEM 570 (D570) is a general-purpose business computer system designed to provide multi-function capabilities for on-line data processing in a simultaneous, interactive transaction processing and batch environment. As the largest member of the Datasystem family offered by the Business Products Group, the D570 supports up to 63 terminal users running under DIGITAL's PDP-11/70 central processing unit. The Commercial Transaction System—500 (CTS-500), a RSTS/E based operating system, is the primary software run on the D570.

Cost-effective systems level performance is achieved through a full range of system features including: large capacity parity memory and high speed cache memory, video and hard copy terminals, various speed line printers and card readers, high speed disk and magnetic tape mass storage subsystems, communications options, and numerous CTS-500 operating system capabilities including multiple language support.

Other optional operating systems supported by the D570 are RSX-11M, DIGITAL's Real-Time Operating System; and IAS, DIGITAL's Interactive Application System.



### WORD PROCESSING 310W

DIGITAL entered the fast-growing word processing market with the announcement of the WPS-8. The WPS-8 was the first in a series of products to address the needs of sophisticated users of text editing equipment. WPS-8 is offered as an adjunct to the DEC Datasystem-310 or other appropriately configured PDP-8 systems. WPS-8 is a stand-alone, single terminal, single user word processing system.

## FINANCIAL SUMMARY

<b>FISCAL YEAR</b>	<b>1976</b>
Total Operating Revenues	\$736,288,000
Income Before Income Taxes	119,400,000
U.S. & Foreign Income Taxes	46,000,000
Net Income	73,400,000
Total Assets	856,038,000
Current Assets	648,109,000
Current Liabilities	149,126,000
Stockholders Equity	606,045,000
No. of Shares Outstanding at Year End	12,944,000
Net Income Per Share	\$5.94
EMPLOYEES AT YEAR END	25,000
SHAREHOLDERS AT YEAR END	17,875





## GENERAL

MILESTONES/FISCAL 1977

## HARDWARE

VT61 AND VT61T

RK06

PDP-11S34

PDP-11S55

LP14

PDP-1134A

LS120 DECWRITER III

PAPERTAPE READER  
FOR THE LA36

## SOFTWARE

RSTS/E V6B

CTS-500

PEAK-11

CTS-300 DICAM

APL-11

DBMS-11

DX/RSTS

## SYSTEMS

D537

DATASYSTEM 357

DECLAB 11/03 AND  
DECLAB 11/34

THE WORD SYSTEM 102

THE DATASYSTEM 320

DECSYSTEM-2050

PDP-11/60

DPM SYSTEMS

DECSTATION

## FINANCIAL SUMMARY

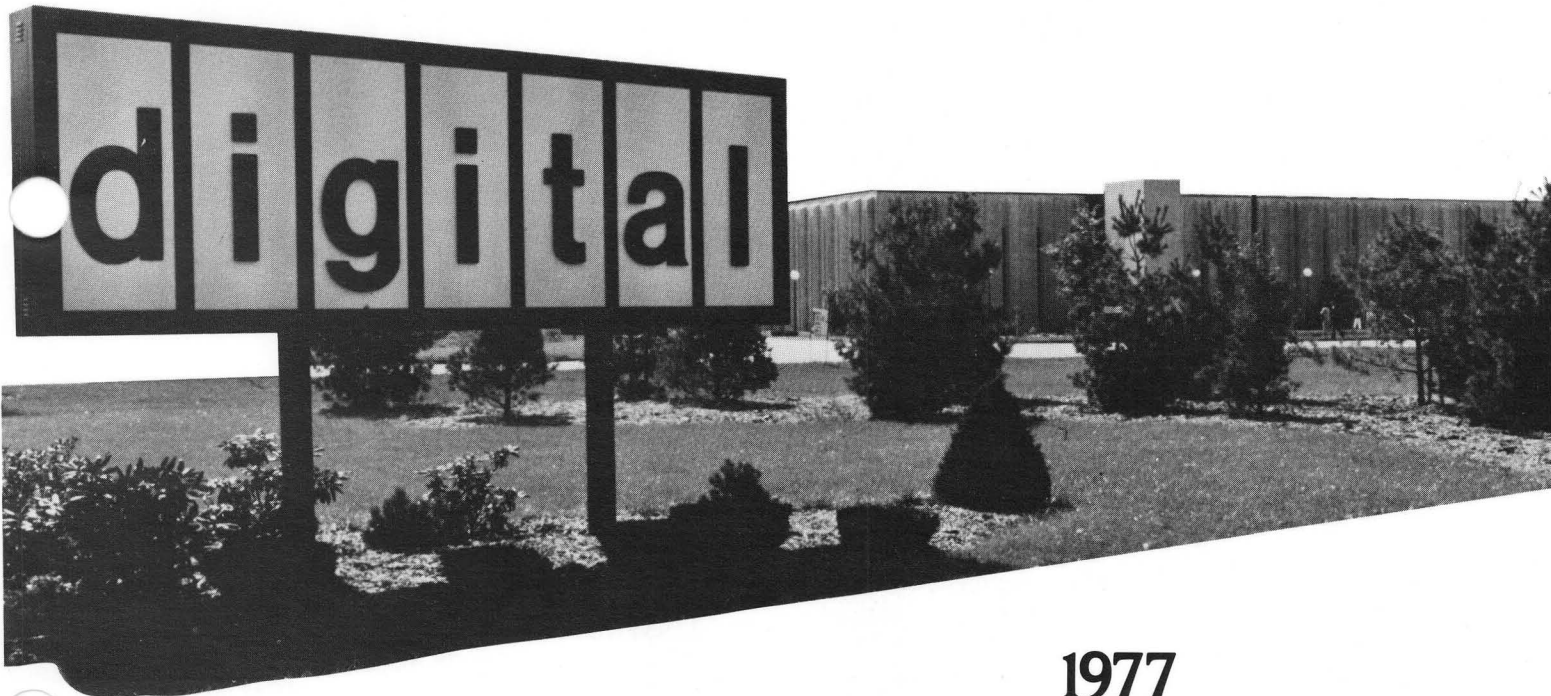

**1977**

7/76-6/77

## GENERAL MILESTONES/FISCAL 1977

### THE GRAPHIC SYSTEMS GROUP

In July, the Graphic Systems Group was formed. Several groups were involved in the formation of this group. They were IPG, OEM, LDP, and ESG. The change of graphic responsibility is a significant and exciting step for DIGITAL. Major advances have been made in graphics hardware technology which have taken advantage of DIGITAL's strengths and have reduced the prices for graphic systems.

### PDP-8 PRODUCT LINE

On July 1st, the PDP-8 Product Line was created. The charter of this product line encompasses the sale of PDP-8 based products to both OEM's and End-Users in all Market places. This product line was formed to emphasize our commitment to this product and the important role it plays in our markets. According to one study for FY75, the PDP-8 was the fourth largest Minicomputer Company when treated as a separate group. DIGITAL also has a very strong commitment to the large base of customers represented by over 30,000 PDP-8's installed.

### 50,000TH LA36

In September, DIGITAL established another milestone in the minicomputer industry when the 50,000th LA36 DECwriter II rolled off the assembly line in Westfield, Massachusetts.

### GOVERNMENT INFORMATION SYSTEMS

October 1975—DIGITAL formed the Government Information Systems Product Line to more adequately serve the expanding market within National Governments for DIGITAL's products in the areas of data communications and data processing.

September 1976—The PDP-11 architecture was chosen as the standard computer architecture for fourth generation military applications within the U.S. Government.

November 1976—Under license from Digital Equipment Corporation, Norden, Division of United Technologies, introduced their first militarized PDP-11, the PDP-11/34M. With this announcement, military customers now had available for the first time a computer system which would operate in hostile environments that were completely compatible with commercially available computers, thus providing significant cost savings, particularly in the area of common software development.

January 1977—DIGITAL selected as the computer supplier for the Autodin II system. This system will provide a worldwide communication network linking all military bases of the U.S. Department of Defense.

### 1000TH 11/70 DELIVERED

In January, the Corporation announced the delivery of the 1000th PDP-11/70. The PDP-11/70, the most powerful member of the PDP-11 family, is proving to be a great success for DIGITAL. PDP-11/70 systems have been installed in such diverse applications as banking, factory data collection, education, research, telephone switching, insurance, government information systems, and transportation.

### LARGE COMPUTER GROUP REORGANIZES INTO INDEPENDENT MARKET-ORIENTED PRODUCT LINES

In January, the Large Computer Group reorganized into a number of independent, market-oriented product lines. This segmenting of our former product organization into individual market groups is consistent with DIGITAL's overall structure. It allows focus on applications and markets of greatest growth potential, makes for easier interaction with DIGITAL market-oriented product lines, and will facilitate the growth of large computer sales.

## HARDWARE

1977



### VT61 AND VT61T

The VT61 and the VT61T (Typeset version) are buffered display terminals. The VT61 is a general purpose, high-end display terminal.

### PDP-11S34

The 11S34 is an 11/34 packaged system with a dual RK06 disk system. It offered a 28 Megabyte disk system in a very competitive price range. The basic 11S34 includes a PDP-11/34-LM (or MM), Controller for up to eight RK06 drives (RK611), dual RK06 disk drives in separate pedestal cabinets, LA36 DECwriter, and System cabinet (H960-CA).

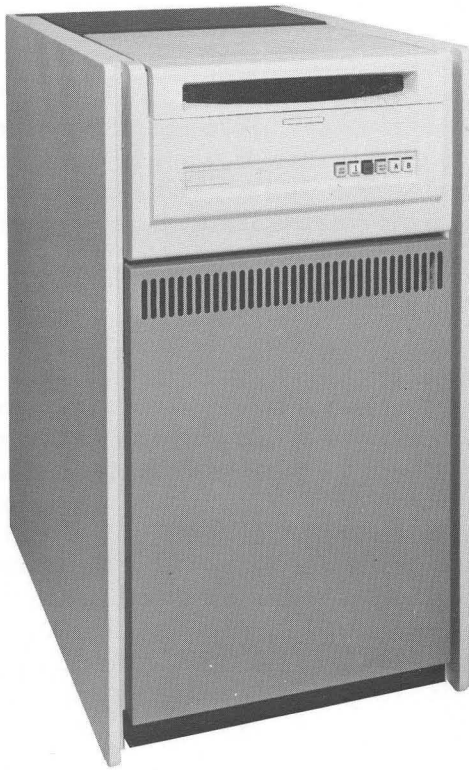

### RK06

In August, DIGITAL announced a medium capacity disk drive designed for the small to mid-range PDP-11 configurations. It features a storage capacity of 14 million bytes in a compact cartridge design and uses technology similar to the RP disk drive family to provide reliability and high performance. A completely new disk cartridge, the RK06K was designed for the RK06 for high reliability and convenience. The RK06 is a medium capacity storage subsystem and fits between the RK05 and the RP families.



### PDP-1134A

In March, the Corporation announced the 1977 model of the PDP-11/34—the PDP-1134A. It contains several enhancements which affect configuration and add-on rules. An 1134A is an 11/34 with the following changes: the 2-board 1134 CPU has been modified to directly interface with the FP11-A floating point processor instead of requiring the FP11-AU processor upgrade; the +5 volt regulators have been enhanced to 32 amps and reliability has been improved; chassis and power distribution have been changed to distribute the additional +5 volt power; and, the bootstrap has been revised to the M9301-YF version which supports the RK06.

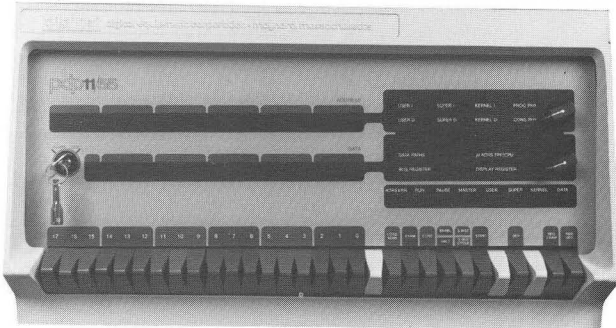

### PDP-11S55

In September, the PDP-11S55 was announced. The 11S55 is a PDP-11/55 based computer system and consists of the following components: an 11/55, 32K byte bipolar plus 32K byte core memory; an FP11-C, the industry's fastest floating point processor with 6.75  $\mu$ sec. double precision divide; an RK611, 14M byte, disk cartridge drive and controller; an RK06, additional free standing 14M byte disk cartridge drive for a total of 28M bytes of storage; and two H960-D cabinets.

### LP14

In response to the demand for a more competitive, high speed line printer for PDP-11 systems, a totally new printer was announced in March, the LP14. The LP14 is available in two models—900 lines per minute with a 64 character drum, and 660 lines per minute with a 96 character drum. It has all the important features required of a high speed line printer for data centers and business data processing.



### LS120 DECWRITER III

The LS120 DECWRITER III was announced as a low-cost, interactive hard copy keyboard terminal designed for operation at 1200 baud. The LS120 offers all the features of the LA36 and LA180 plus additional forms handling and communications capabilities.



### PAPERTAPE READER FOR THE LA36

The PRS01 is a small portable papertape reader that connects into the serial line of a system console or terminal. The reader provides a convenient and inexpensive method of loading papertapes using the keyboard device codes of the terminal. It is designed primarily for loading maintenance and diagnostic programs. The reader produces a 20mA serial asynchronous signal; it can be interconnected to a console device or terminal (by means of a "Y" cable, standard with the PRS01), or to the current loop input of an approved interface if no console device is available.

### RSTS/E V6B

In February, RSTS/E V6B was shipped. It is a PDP-11 based, multi-language timesharing system with features which also make it attractive as a base for multiterminal applications systems. RSTS/E V6B is an updated and enhanced version of the RSTS/E operating system.

### CTS-500

In August, the Commercial Products Group announced major enhancements to field-proven software supported by new hardware packaged in the more attractive corporate cabinets. Major highlights of this product included a change of the name CTS-500/E (Commercial Time-sharing System/Extended) to CTS-500 (Commercial Transaction System). This name change reflects the new transaction processing enhancements to the BASIC-PLUS language availability of DIBOL-11 with DECFORM on CTS-500 (RSTS/E V6B based) software with a coherent model number scheme. These new features offered a significant increase in the features, functions, and benefits of CTS-500/E.

### PEAK-11

In October, Laboratory Data Products announced PEAK-11 Version 1, a unique LDP product. PEAK-11 provides more of the "tools" needed by the LDP customer for acquiring and analyzing data from analytical instrumentation than from previous LDP products. PEAK-11 is a hardware/software peak processing system using the flexible RT-11 Foreground/Background Operating System and MU BASIC for background programming and communication with the foreground PEAK-11 software. A variety of laboratory instruments, including gas chromatographs, liquid chromatographs, and auto analyzers, can be interfaced to the PEAK-11 system for data acquisition and peak processing.

### CTS-300 DICAM

CTS-300 Datasystem Interactive Communications Access Method, a software package which runs under the CTS-300 operating system, permits DIBOL application programs to exchange data with a 360/370 HOST system on an interactive basis. The interactive capacity is achieved by using the same communication procedures as the 3271 remote keyboard display and printer controller, which the 360/370 supports as a standard option. This approach virtually assures compatibility.

### APL-11

Announcement was made in December of another programming language to the PDP-11 family. APL-11 is a mathematically-oriented language especially suitable for handling numeric and character array-structured data, but flexible enough to solve problems in text handling and commercial data processing.

### DBMS-11

In January, DBMS-11 (Data Base Management System) was released after a successful period of field testing. DBMS-11 is the first CODASYL DBMS implementation for a minicomputer in the industry.

### DX/RSTS

In April, DIGITAL announced DX/RSTS, a software utility that allows the RSTS/E customer to enjoy "shared use" of the large capacity disk storage units and high speed line printers, along with the powerful text editing and record processing features of DIGITAL's word processing systems. DX/RSTS enables PDP-8 based Word Processing systems to be "linked" to PDP-11 based RSTS/E timesharing systems. WS-100 single terminal and WS-102 multiterminal users with communications option can now transmit and store documents at the respective "host" system to act as a document data bank, storing word processing documents in the larger "host" storage units.

## SYSTEMS

1977



### DATASYSTEM 357

In September, the Commercial Products Group announced the newest model in the Datasystem 350 family, the Datasystem 357. The Datasystem 357 features the following: RK06 Disks, PDP-11/34 processor with MOS memory. The Datasystem 357 combines the performance of the 11/34 CPU with the field proven reliability and lower cost of MOS memories. The Datasystem 357 also uses new Datasystem cabinets.

### D537

In September, the Commercial Products Group announced the DECdatasystem 537. The D537 expanded the saleability of the D530 family series with the inclusion of the RK611/RK06 dual spindle 28M byte storage subsystem. This low capacity rotating storage facility has the same device transfer rate as the RP04, RP05, RP06 based storage systems at a significantly lower price. In addition, compatibility with other D530 addition systems was maintained by use of the 11/34 CPU and the CTS 500/E operating system. This system is mounted in a single corporate Hi-Boy cabinet (H9602) and separately mounted dual RK06 disk drives.



### THE WORD SYSTEM 102

In October, DIGITAL announced the introduction of our WORD SYSTEM 102. It has all the power and flexibility of the WS-100 word processing system but with two terminal capability. The new WS102 features an enhanced version of WPS-8, DIGITAL's ready-to-use word processing software.

## SYSTEMS

1977

### DECLAB 11/03 AND DECLAB 11/34

In October, the Laboratory Data Products Group announced the newest members of the DECLAB family. The range of systems offered, from the low-cost DECLAB 11/03 to the high performance DECLAB 11/34, gave our customers the ability to truly match a DECLAB system to both their laboratory computer requirements and their budget.



### DECLAB 11/03

The DECLAB-11/03 introduces the LSI-11 in a complete, lower cost, laboratory data acquisition system. The DECLAB-11/03 systems with their hardware fixed and floating-point arithmetic unit have the computational powers of much more expensive computers. Combining the computational power with the A/D converters, D/A converters and DIGITAL I/O, the DECLAB-11/03 offers a low-cost solution to many laboratory applications.

### DECLAB-11/34

With the introduction of the DECLAB-11/34, the tradition of DIGITAL's leadership in computers for laboratory applications is continued. The range of DECLAB-11/34s, from the inexpensive yet powerful floppy-based DECLAB-11/34-E with its graphics display capabilities can meet a variety of laboratory needs. These DECLABs are expandable systems, by adding such options as the powerful FP11-AU, floating point processor or AM11-K 48-channel expansion multiplexer for the AD11-K. The DECLAB-11/34 can expand as the application expands.

### THE DATASYSTEM 320

In November, DIGITAL's Commercial Products Group announced the Datasystem 320, an entry system for both OEM's and End-user's that can grow with a customer's needs and take full advantage of a company's commercially-oriented software. This represents a PDP-11 based entry system for small businesses and distributed networks, and also indicates DIGITAL's commitment to the commercial marketplace. The Datasystem 320 brings the company's leading technology, the LSI-11 microprocessor, and a DIBOL Instruction Set, to the realm of business applications for the first time. The DEC Datasystem 320 builds upon the LSI-11 processor to provide two new models, D322 and D324.



The Datasystem 322 is a floppy diskette based system with 32K bytes of memory packaged in the same desk as the DS310 and using a VT52 CRT. It can be configured with more memory, additional terminals, more mass storage, and a variety of printers.

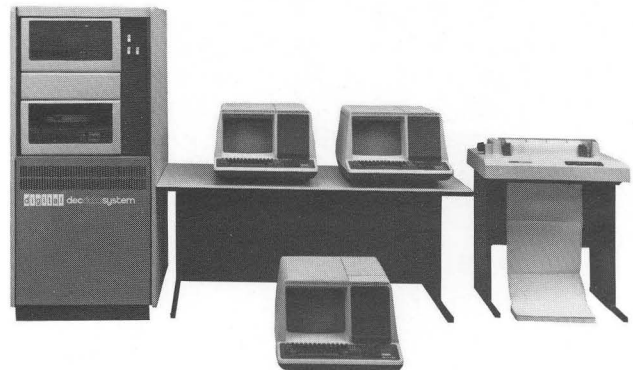

The Datasystem 324, also using an LSI-11, is an RK05 disk based system. Offered in the new Datasystem cabinets, the basic system consists of 32K bytes of memory, a VT52, and an RK05J and RK05F. It, too, can have more memory, more terminals, more mass storage, and a variety of printers.

The DEC Datasystem 320 offers exceptional performance in the commercial data processing environment. This is due in large part to the inclusion of a DIBOL Instruction Set, referred to as DIS. It consists of a series of hardware-executed instructions micro-programmed in read-only memory. The instruction set is composed of three groups of command types: character string moves, searches, and decimal arithmetic.

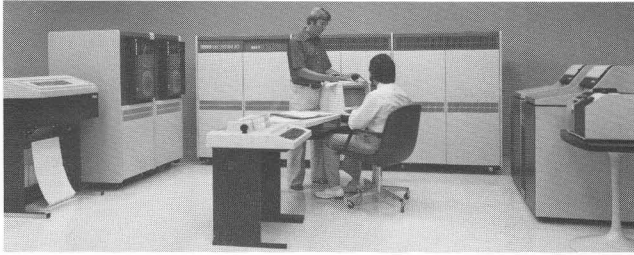

### DECSYSTEM-2050

In November, DIGITAL announced the DECSYSTEM-2050, second member of the DECSYSTEM-20 family. The system features cache memory and the TOPS-20 high performance virtual memory environment that provides an impressive multi-tasking, multi-programming capability to support timesharing, transaction processing, and multi-stream batch processing. The system can support up to 128 asynchronous communication lines, features 3.2 billion characters of on-line disk storage, and will handle the full line of DECSYSTEM-20 peripheral subsystems.



### DPM SYSTEMS

Introduced in March 1977 by the Industrial Products Group, Distributed Plant Management (DPM) systems integrate factory data management and input/output (I/O) processing into a single, efficient system for managing production resources. The DPM concept combines on-line processing, real-time data acquisition, microprocessor control, distributed computing, and hierarchical computer systems—all integrated through one low-cost communication link.

DPM's factory data management subsystem collects data from machines and employees with the interactive RT801, 803, and 805 terminals. A DPM50 I/O subsystem monitors machines and processes with real-time analog and digital interfaces. Sharing a common set of new I/O functional modules, the subsystem can function as a distributed (DPM50) or a stand-alone (IP300) element, utilizing its LSI-11 microcomputer to put intelligence at the task site. The DECdataway® links all system elements inexpensively and reliably to the PDP-11/34 or 11/70 system host.



### PDP-11/60

In March, DIGITAL announced a new mid-range price/performance system, the PDP-11/60. The 11/60 offers more features for significant performance and reliability than any other computer in its class. Designed around the proven architecture of the UNIBUS, the PDP-11/60 offers real-time application as well as multi-user and multi-tasking time-share applications. A combination of unique features are offered by the 11/60 which normally are found in larger, more costly computers or partially implemented on others that are PDP-11 class equivalent. The PDP-11/60 offers user control store features previously unavailable from DIGITAL, as well as several 11/70 class features such as cache memory and RAMP.



### DECSTATION

In May, the Corporation announced its newest computer, DECstation, a family of components centered around the VT78 Video Data Processor. This processor is a complete PDP-8 computer system implemented with large scale integration technology so that it could be packaged inside the shell of a display terminal. DECstation is sold as an Intelligent Terminal and as a floppy-based, small system by the PDP-8 and Word Processing groups. Designed for an interactive environment, the primary emphasis is on system capability, hence the large 16Kw(32Kb) memory and the array of I/O controllers.



## FINANCIAL SUMMARY

<b>FISCAL YEAR</b>	<b>1977</b>
Total Operating Revenues	\$1,058,614,000
Income Before Income Taxes	176,400,000
U.S. & Foreign Income Taxes	67,900,000
Net Income	108,500,000
Total Assets	1,070,432,000
Current Assets	805,021,000
Current Liabilities	230,855,000
Stockholders Equity	735,463,000
No. of Shares Outstanding at Year End	38,990,558
Net Income Per Share	\$2.78
EMPLOYEES AT YEAR END	36,000

# DIGITAL'S MANUFACTURING CAPABILITY

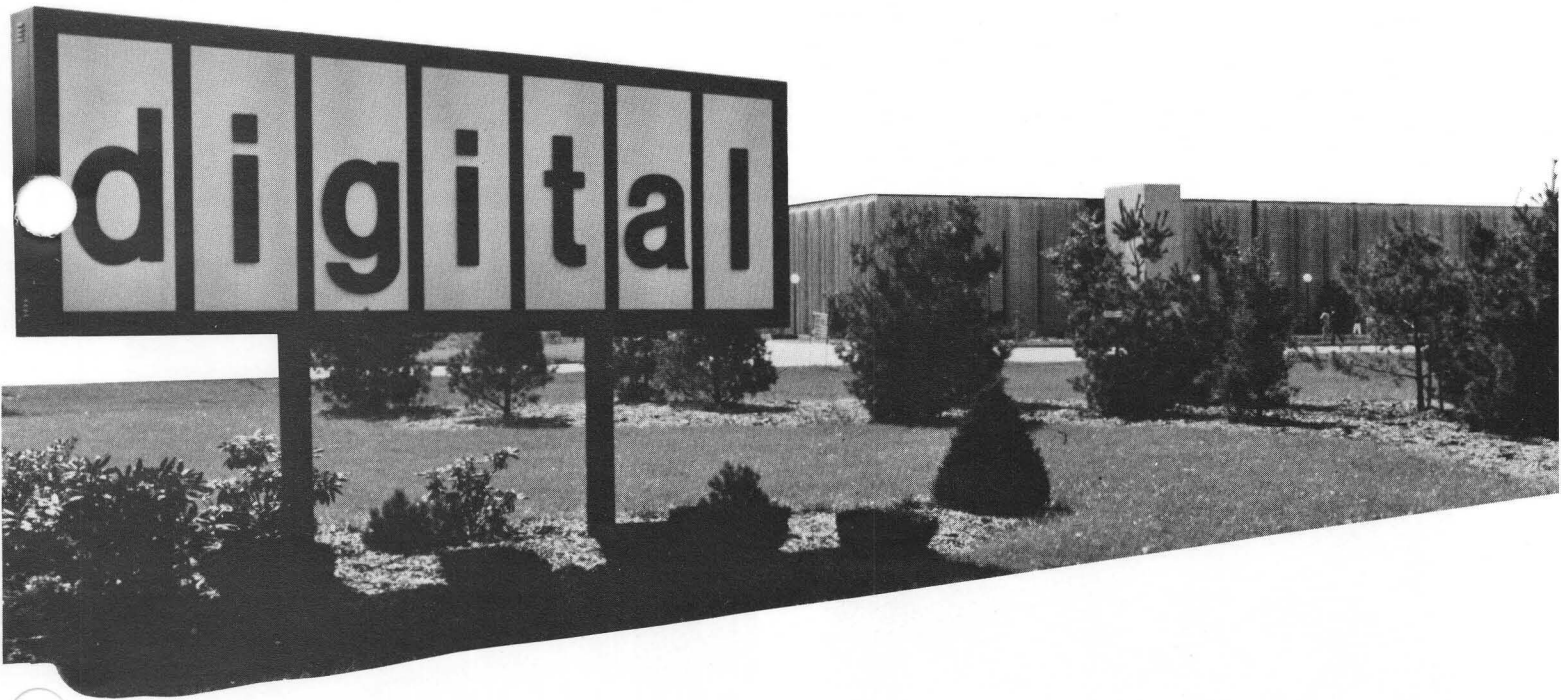

## DIGITAL'S MANUFACTURING CAPABILITY

DIGITAL has expanded its manufacturing ability tremendously since its beginnings in the Maynard Mill. Manufacturing facilities now exist world-wide. The following section presents each manufacturing facility and describes its size, the number of personnel, and the products manufactured.

PLANT	ACTIVITY	SIZE/SQ. FT.	NO. OF PEOPLE
Maynard/Acton	Modules, Test Equipment	300K	1200
Puerto Rico:			
San German	Modules	230K	2100
Aquadilla	CPU's	180K	800
Marlboro/ Natick/ Worcester	Electromechanical, Memories, LSI	170K	900
Marlboro Burlington/ Derry	DEC-10 CPU's	225K 150K	600 450
Salem, NH	Systems, Options	700K	600
Colorado/ Mt. View	Disks, Tapes	110K	300
Springfield	Tapes	200K	800
Albuquerque	Terminals	320K	375
Westfield	Terminals	600K	1900
Phoenix	Terminals	375K	1200
Far East:			
Taiwan	Core Stringing	90K	750
Hong Kong	Modules	120K	1650
Augusta	Options	60K	100
Westminster	Systems	690K	2300
Galway, Ireland	CPU's, Systems	250K	1000
Ayr, Scotland	Systems	80K	150
Kanata, Canada	Logics, Systems	50K	400

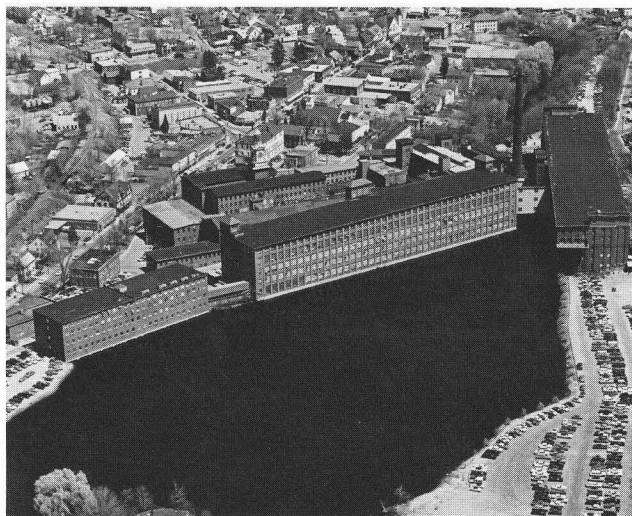

**MAYNARD**

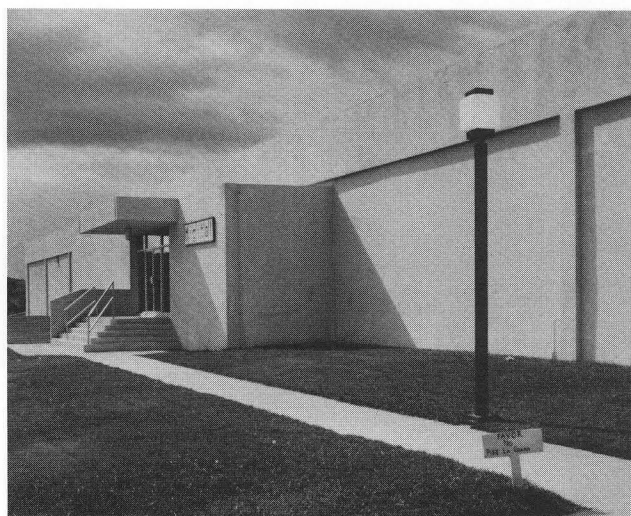

**PUERTO RICO**

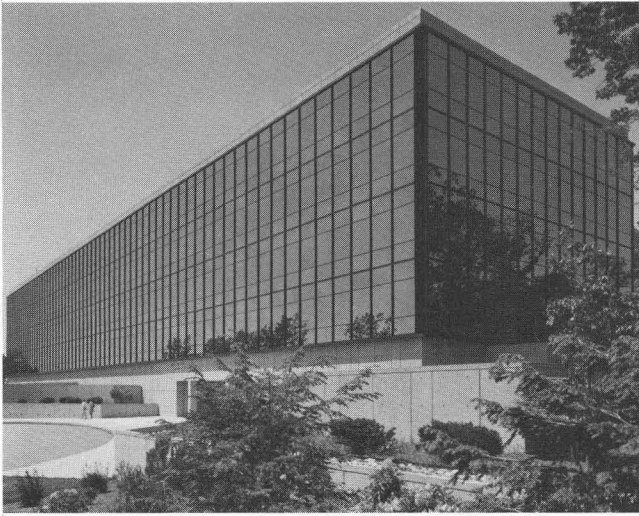

MARLBORO

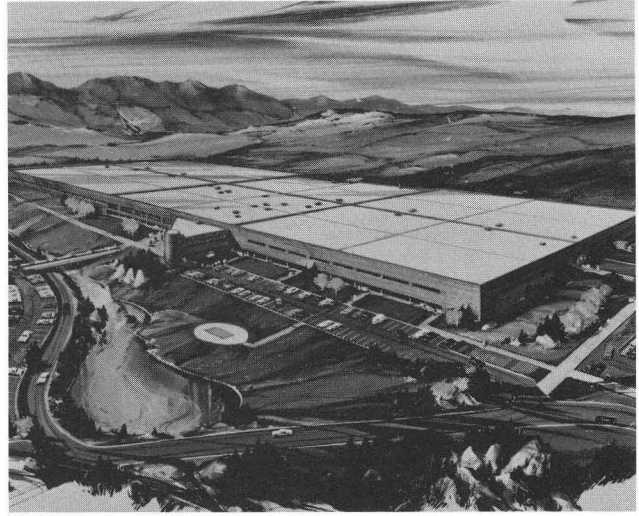

COLORADO/MT. VIEW



NATICK



SPRINGFIELD

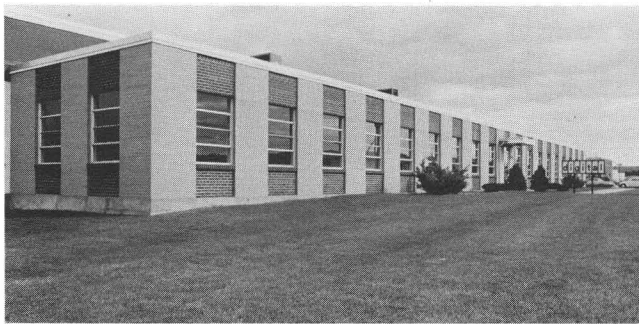

SALEM, N.H.



ALBUQUERQUE

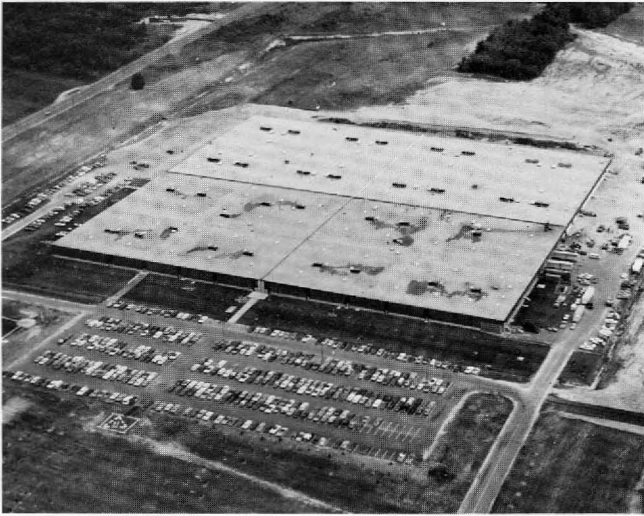

WESTFIELD

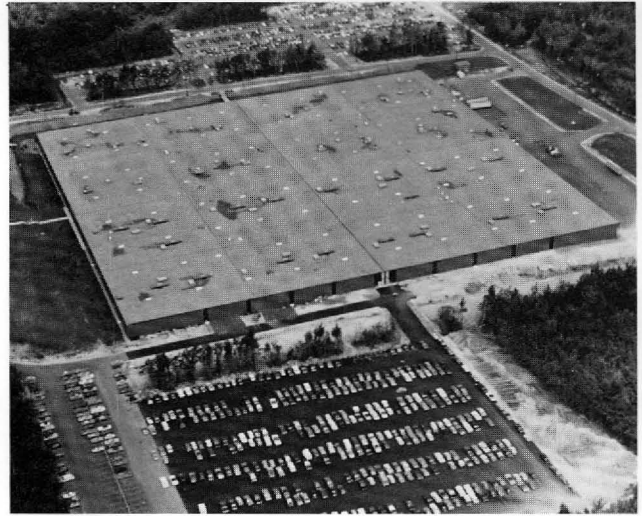

WESTMINSTER

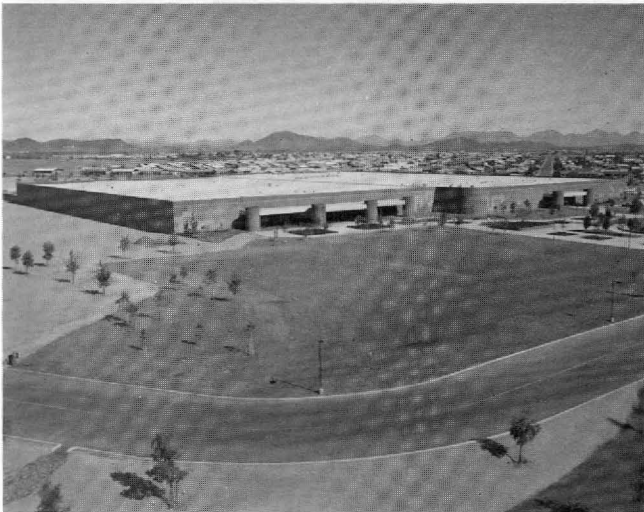

PHOENIX

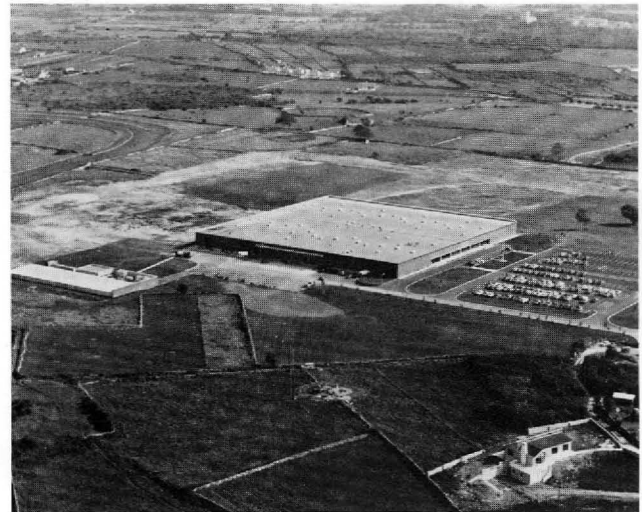

GALWAY

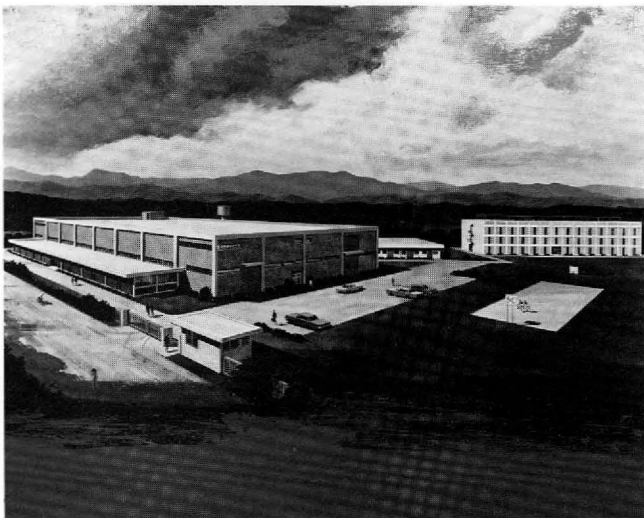

TAIWAN



KANATA, CANADA

# SYSTEM, OPERATING REVENUES AND PRODUCT SUMMARIES

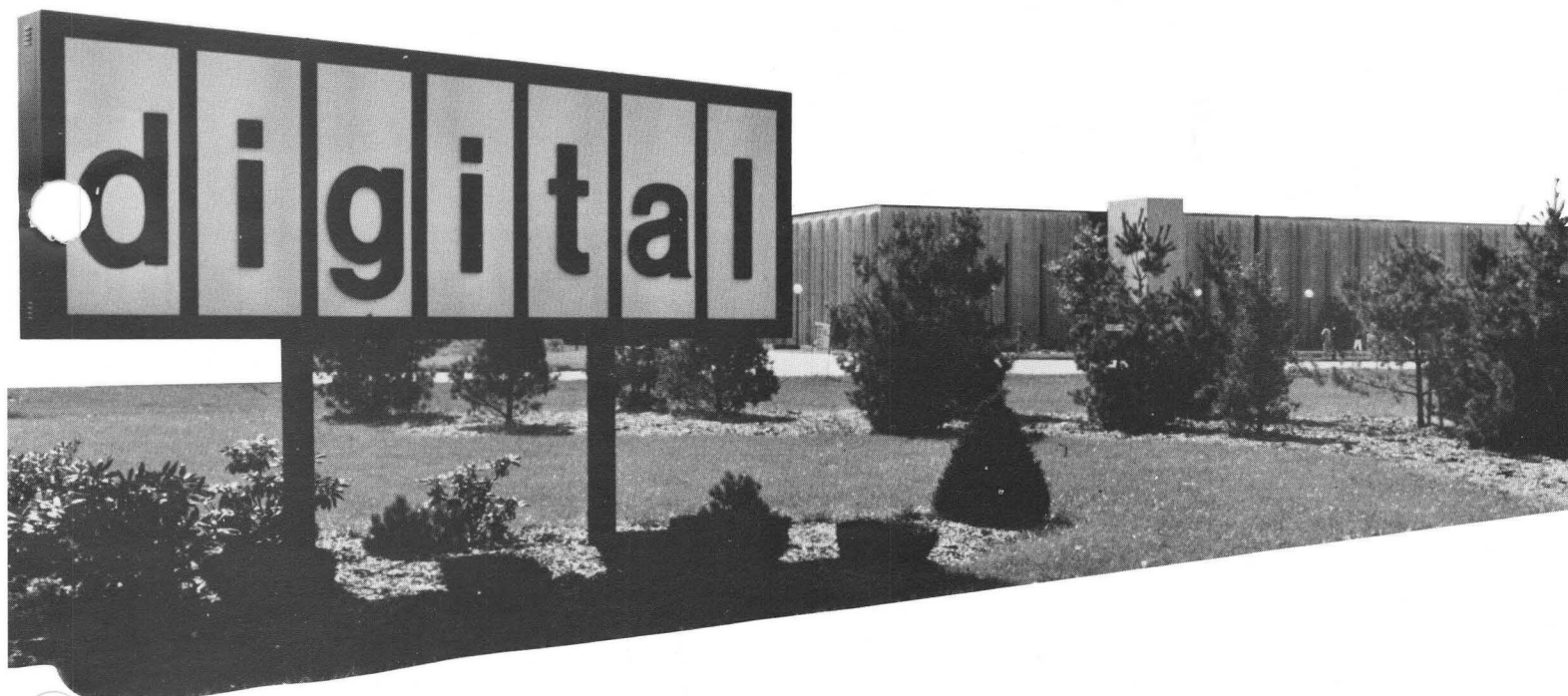

**INSTALLED MINICOMPUTER SYSTEMS**

**as of January 1, 1977**

(Source: International Data Corporation/  
EDP Industry Report, 4/22/77)

<b>NAME OF MANUFACTURER</b>	<b>COMPUTER MODEL</b>	<b>DATE OF FIRST INSTALLATION</b>	<b>TOTAL NUMBER OF INSTALLATIONS</b>
DIGITAL EQUIPMENT CORP.	PDP-1	11/60	41
	PDP-4	8/62	33
	PDP-5	9/63	90
	PDP-7	11/64	115
	PDP-8,I,L,S	5/65	9,450
	PDP-8A, E, F, M,	4/71	27,550
	PDP-8/LINC	9/66	134
	PDP-9 & 9L	12/66	450
	PDP-11-04, 05, 10, 15, & 20	3/70	24,350
	PDP 11-34, 35, & 40	1/73	8,750
	PDP 11-45, 50, & 55	4/72	3,000
	PDP-12	4/69	765
	PDP-15	2/70	855
	PDP-11/70	7/75	1,100
	LSI-11 & 11/03	6/75	4,750
	SUBTOTAL		

# DIGITAL EQUIPMENT CORPORATION

## TOTAL OPERATING REVENUES

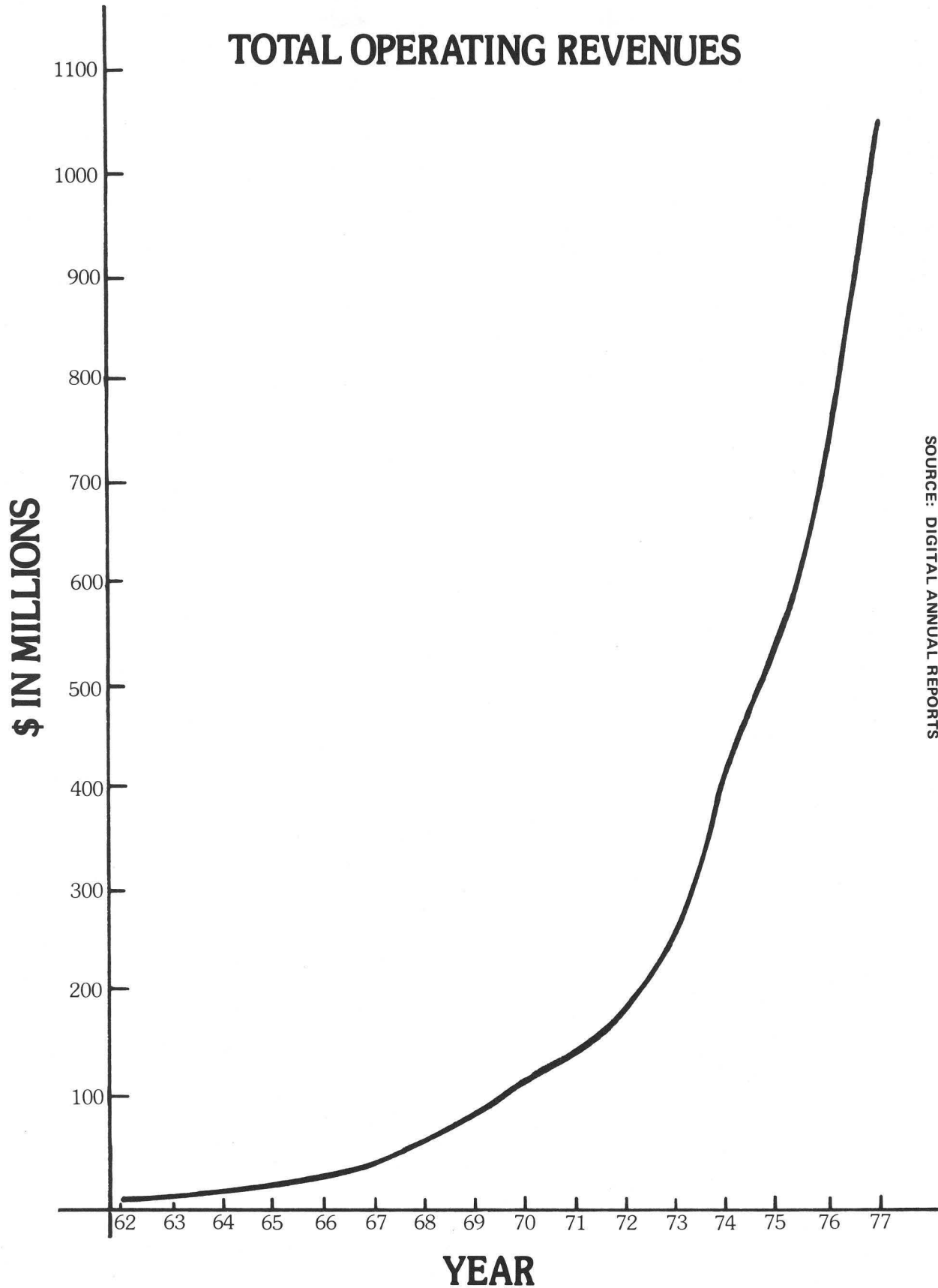

SOURCE: DIGITAL ANNUAL REPORTS



# DEC HARDWARE PRODUCT FAMILIES

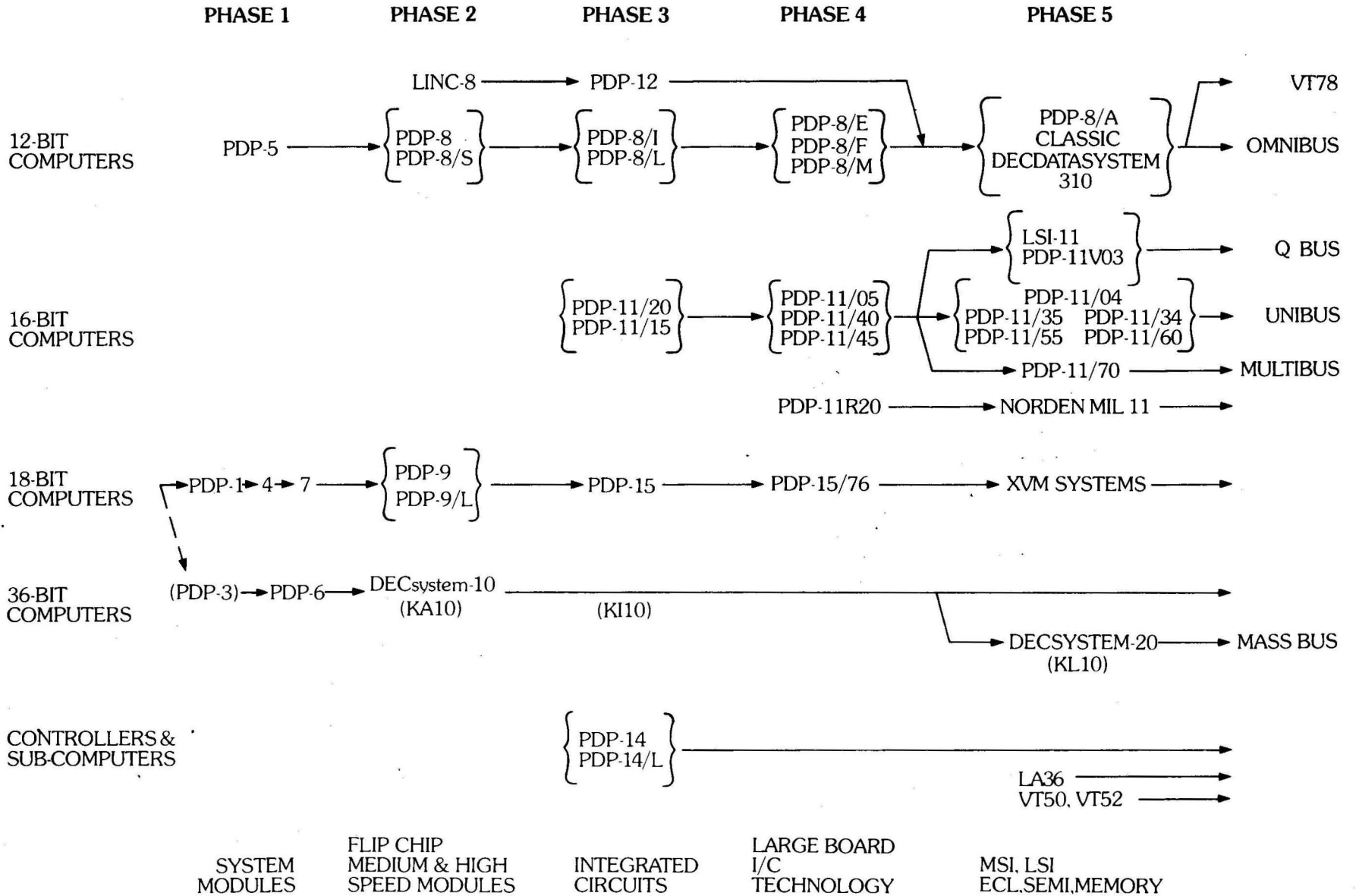



**digital**

**DIGITAL EQUIPMENT CORPORATION**