



**4000 / 260 LF**

**4000 / 260 LFC**

Monochrome and Color Terminals

User's Guide

598-0011148



Before using this information and the product it supports, be sure to read the general information under “Notices.”

It is the policy of Boundless Technologies, Inc. to improve products as new technology, components, software, and firmware become available. Boundless Technologies, therefore, reserves the right to change specifications without prior notice.

All features, functions, and operations described herein may not be marketed by Boundless Technologies in all parts of the world. In some instances, photographs are of equipment prototypes. Therefore, before using this document, consult your Boundless Technologies representative or Boundless Technologies office for information that is applicable and current.

Note that Boundless Technologies appreciates receiving suggestions and comments on its publications. After reading this guide, please comment and return the comment sheet that has been provided.

Copyright © Boundless Technologies, Inc. 2003.  
Hauppauge, New York  
All rights reserved.



---

# This guide...

is a user's manual and contains all of the information necessary to install, setup, and use the 4000/260 LF product.

More detailed information on programming using control codes and escape sequences, default strings and character sets, international language support, etc. can be obtained by calling the **Boundless Technologies Hotline** at:

**USA and Canada calls . . . . 1-800-231-5445**

**International calls . . . . . 1-631-342-7400**

At the options menu, press 2 for "Product Information," then request the following:

**260xx Programmer's Reference Guide**

**Part Number: 598-0005035**

This manual is offered to our customers at no additional charge. When calling to order, please have your terminal's **serial number** available.

# Contents

<b>Preface</b>	<b>iii</b>
How to Connect/Disconnect the Terminal .....	iv
Notices .....	iv
Trademarks and Service Marks .....	v
Electronic Emission Notices .....	v
Safety Notices .....	vi
<b>Introduction</b>	<b>7</b>
Features .....	2
Vertical Mount: .....	3
Under-Desk Mount: .....	3
Wall Mount: .....	4
Physical Features .....	5
Keyboards .....	6
Display Fields .....	7
Usage Notes .....	8
Communications .....	9
Receive Flow Control .....	9
Transmit Flow Control .....	9
Host/Printer Port 1 (DB25) .....	9
Host/Printer Port 1 (RJ45) .....	10
Video Port (DB15) .....	10
Keyboard Ports (Mini-din or RJ11) .....	10
Host/Printer Port 2 .....	11
Parallel Printer Port .....	11
Terminal To Modem (or DCE Host) .....	12
Screen Display And Pages .....	13
Bottom Status/Label Line Display .....	13
Visual Effects Of Screen And Page Lengths .....	14
<b>Installation</b>	<b>15</b>
Step 1 - Physical Connections .....	15
Step 2 - Number Of Sessions .....	15
Step 3 - Link Ports To Sessions .....	15
Step 4 - No Printer Option .....	16
Step 5 - Determine Your Serial Port(s) Protocol .....	16
Step 6 - Alternate Input Data Setup Selection .....	16
Step 7 - Host/Printer Setup Selection .....	16
Step 8 - Modem Control Setup Selection .....	16
Step 9 - Communications Protocol Settings .....	16
Connection A - DTE Host On EIA .....	16
Connection B - DTE Host On Aux .....	17
Connection C - DCE Host/Modem On EIA .....	17
Connection D - DCE Host/Modem On Aux .....	17
Connection E - Serial Printer On EIA .....	17
Connection F - Serial Printer On Aux .....	17
Connections G & H - Serial Or Parallel Printer On Parallel .....	17
Step 10 - Emulation Setup Selection .....	17
Step 11 - Additional Setup Options .....	17
Step 12 - Save Parameters .....	18
Step 13 - Establish Communications .....	18
Host/Printer Connection Guide .....	19
Common Setups .....	21
User Settings .....	22
<b>Setup</b>	<b>23</b>
Overview .....	23

Entry And Exit.....	23
Printing .....	23
Saving Parameters .....	23
Movement Inside Menus .....	24
Action Fields .....	24
Dual Session Mode.....	24
Setup Map .....	25
Quick: F1 .....	27
General: F2.....	28
Display: F3 .....	29
Keyboard: F4 .....	30
Keys: F5 .....	31
Ports: F6.....	33
Host: F7.....	33
Print: F8 .....	34
Emulation: F9 .....	34
ASCII Emulations.....	34
ANSI Emulations.....	35
ANSI Emulations.....	35
Tabs: F10.....	36
Answerback: F11 .....	36
Program: F12.....	37
Execute: Prt Sc .....	38
Edit Fields.....	38
Glossary of Terms.....	39
Page Reset.....	39
Terminal Parameters .....	39
Session Parameters.....	39

## **Desk Accessories 40**

Desk Accessory Menu .....	40
Direct Entry .....	40
Exiting A Desk Accessory .....	41
Inhibiting Access .....	41
Calendar .....	41
Clock .....	42
Calculator .....	43
ASCII Chart .....	44
Diagnostic Menu .....	44
Color Utility .....	45

## **Compose 46**

ANSI-Multinational Compose Sequences .....	46
ANSI-ISO Latin-1 Compose Sequences .....	48

## **Local Key 49**

Page Configurations - Single Host Mode.....	51
Page Configurations - Dual Host Mode .....	51

## **Note To Installer 52**

## **Technical Support 52**



# Preface

This product is in conformity with the protection requirements of EU Council Directive 89/336/EEC on the approximation of the laws of the Member States relating to electromagnetic compatibility.

Boundless Technologies cannot accept responsibility for any failure to satisfy the protection requirements resulting from a non-recommended modification of the product, including the fitting of non- Boundless Technologies option cards.

This product had been tested and found to comply with the limits for Class B Information Technology Equipment according to CISPR 22/European Standards EN 55022. The limits for Class B equipment were derived for typical environments to provide reasonable protection against interference with licensed communication devices.

## How to Connect/Disconnect the Terminal

### To Connect:

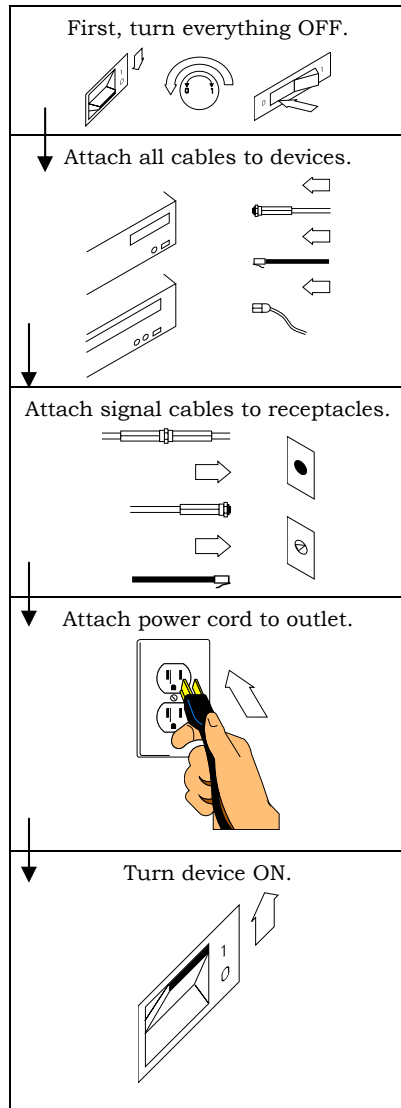

Note: In the UK, by law, the telephone cable must be connected after the power cord.

### To Disconnect:

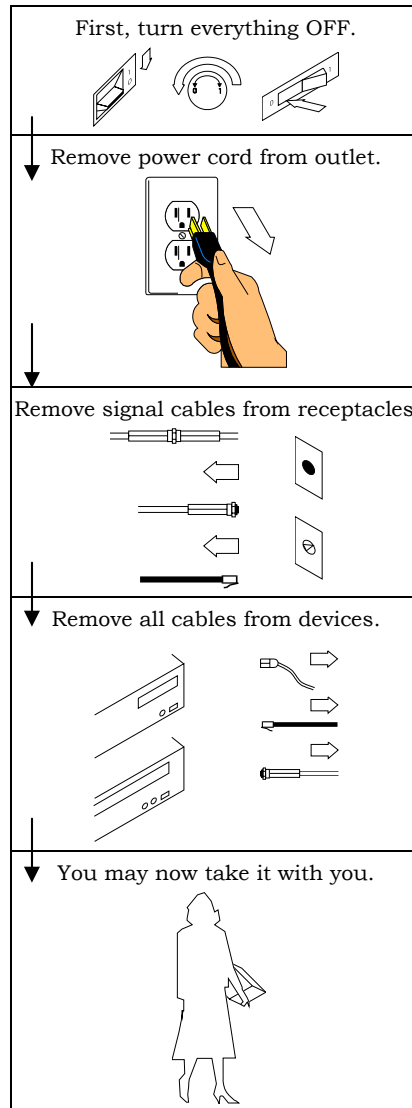

Note: In the UK, by law, the power cord must be disconnected after the telephone line cable.

## Notices

References in this publication to Boundless Technologies products, programs, or services do not imply that Boundless Technologies intends to make these available to all countries in which Boundless Technologies operates. Any reference to an Boundless Technologies product, program, or service is not intended to state or imply that only Boundless Technologies product, program, or service may be used. Any functionally equivalent product, program, or service that does not infringe any of Boundless Technologies' intellectual property rights may be used instead of Boundless Technologies product, program, or service. Evaluation and verification of operation in conjunction with other products, except those expressly designated by Boundless Technologies, are the user's responsibility.

This publication could contain technical inaccuracies or typographical errors.

This publication may refer to products that are announced but are not currently available in your country. Boundless Technologies makes no commitment to make available any unannounced products referred to herein. The final decision to announce any product is based on Boundless Technologies' business and technical judgment.

The drawings and specifications contained herein shall not be reproduced in whole or in part without the written permission of Boundless Technologies.

## Trademarks and Service Marks

The following terms are trademarks of these companies:

ADDS Viewpoint	Boundless Technologies, Inc.
Centronics	Centronics Data Computer Corporation
CSA	Canadian Standards Association
DEC VT320/220/100	Digital Equipment Corporation
IBM	International Business Machines Corporation
MENTOR	Boundless Technologies, Inc.
SCO	Santa Cruz Operations, Inc.
TVI 925	TeleVideo Systems, Inc.
UL	Underwriters Laboratories Inc.
WYSE	Wyse Technology Inc.
WYSE 50/50+/60/120/150	Wyse Technology Inc.

## Electronic Emission Notices

### Federal Communication Commission (FCC) Statement

Note: This equipment has been tested and found to comply with the limits for a Class A digital device, pursuant to Part 15 of the FCC Rules. These limits are designed to provide reasonable protection against harmful interference when the equipment is operated in a commercial environment. This equipment generates, uses, and can radiate radio frequency energy and, if not installed and used in accordance with the instruction manual, may cause harmful interference to radio communications. Operation of this equipment in a residential area is likely to cause harmful interference, in which case the user will be required to correct the interference at his own expense.

Properly shielded and grounded cables and connectors must be used in order to meet FCC emission limits. Boundless Technologies is not responsible for any radio or television interference caused by using other than recommended cables and connectors or by unauthorized changes or modifications to this equipment. Unauthorized changes or modifications could void the user's authority to operate the equipment.

This device complies with Part 15 of the FCC Rules. Operation is subject to the following two conditions: (1) this device may not cause harmful interference, and (2) this device must accept any interference received, including interference that may cause undesired operation.

### Canadian Department of Communications Compliance Statement

This equipment does not exceed Class A limits per radio noise emissions for digital apparatus, set out in the Radio Interference Regulation of the Canadian Department of Communications.

### Avis de conformité aux normes du ministère des Communications du Canada

Cet équipement ne dépasse pas les limites de Classe A d'émission de bruits radioélectriques pour les appareils numériques, telles que prescrites par le Règlement sur le brouillage radioélectrique établi par le ministère des Communications du Canada.

### Japanese Voluntary Control Council for Interference (VCCI) Statement

This equipment is Class 1 Equipment (information equipment to be used in commercial and industrial districts) which is in conformance with the standard set by Voluntary Control for Interference by Data Processing Equipment and Electronic Office Machines (VCCI) with an aim to prevent radio interference in commercial and industrial districts.

This equipment could cause interference to radio and television receivers when used in and around residential districts.

Please handle the equipment properly according to the instruction manual.

### Korean Government Ministry of Communication (MOC) Statement

Please note that this device has been approved for business purposes with regard to electromagnetic interference. If you find this is not suitable for your use, you may exchange it for a non-business purpose one.



## Safety Notices

### Danger Notices

A danger notice indicates a hazard that could possibly cause death or serious personal injury. The following danger notices are used throughout this manual.



**DANGER:** To prevent a possible electrical shock when installing the device, ensure that the power cord for that device is unplugged before installing signal cables.



**DANGER:** To prevent a possible electrical shock when adding the device to a system, disconnect all power cords, if possible, from the existing system before connecting the signal cable to that device.



**DANGER:** To prevent a possible electrical shock during an electrical storm, do not connect or disconnect cables or station protectors for communication lines, display stations, printers, or telephones.



**DANGER:** To prevent a possible electrical shock from touching two surfaces with different electrical grounds, use one hand, when possible, to connect or disconnect signal cables.



**DANGER:** To avoid a shock hazard:

- The power cord must be connected to a properly wired and earthed receptacle.
- Any equipment to which this product will be attached must also be connected to properly wired receptacles.



**DANGER:** Electrical current from power, telephone, and communication cables is hazardous. To avoid shock hazard, connect and disconnect cables as shown on the following page when installing, moving, or opening the covers of this product or attached devices.



**DANGER:** The device's switch is not the main disconnect. The device's main power disconnect is the detachable line cord.

### Caution Notice

A caution notice indicates a hazard that could possible cause minor personal injury.

**CAUTION:** This product contains a lithium battery. Do not attempt to exchange or charge the battery. Discard the product as instructed by local regulations for limited lithium batteries. Do not burn.

### Warning Notice

A warning notice indicates the possibility of damage to a program, device, system, or data.

# Introduction

This guide contains information on all areas of the 260lf product. However, not all 260lf terminals are equipped with all the features in this publication (i.e. the descriptions of color features do not apply to the monochrome product).

The terminal you have purchased features a small footprint logic controller and a VGA monitor, while providing support for both ASCII and ANSI terminals, PC-Term and SCO™ Console and AT386. PC 101/102-key keyboard is available for use with the terminal, as well as Compact PC 101-key keyboard.

The dual host capability of the terminal allows you to run two different applications simultaneously. A Setup option is available to view each “session” on the screen in a “split” screen or full screen display.

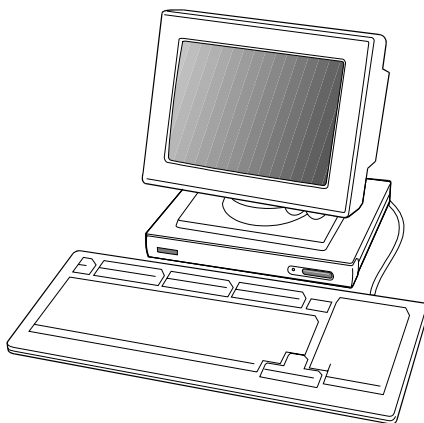

Clock, calendar, calculator, ASCII chart, and diagnostic desk accessories are provided.

For the 260lfc, Color Desk Accessory is available.



The highlighted text shown above is used to identify features that are only available in 260lfc unit.

This terminal also features an easy-to-use Setup menu that is configuration dependent; this means that only the options that are valid for a given emulation or hardware configuration are presented.

Setup also has a “Quick” menu that summarizes all the options critical to the operation of the terminal. Travel between menus is facilitated by function keys that are listed at the top of every menu.

## Features

- Personality:
    - ADDS-Viewpoint™ (ASCII emulation)
    - Wyse™60, Wyse 50/50+ (ASCII emulation)
    - DEC™ VT-320, VT-220, VT-100 (ANSI Emulation)
    - PC Terminal (PC Term)
    - SCO-Console (ANSI Emulation)
    - AT386 (ANSI Emulation)
    - TVI925 (ASCII emulation)
    - Intercolor (ANSI Emulation)
    - Wyse 325, Wyse 350 (ASCII emulation)

---

  - Display:
    - Dual session available in full or split screens
    - VGA monitor (Color or Monochrome).
    - Selectable Screen Saver
    - 26, 44, or 49 Row Display with Top and Bottom Status Lines
    - 80 or 132 Column Display
    - Double High/Double Wide Display
    - Up to 4 Pages of Memory
  - Character Sets:
    - Support for 17 different language character sets: US, UK, Danish, Finnish, French, German, Norwegian, Portuguese, Spanish, Swedish, Dutch, Belgian-Flemish, French-Canadian, Italian, Latin-American, Swiss- French, Swiss-German
    - Numerous Standard, Graphic, and Supplemental Character Sets
  - Communications:
    - Serial RS-232-C Host/Printer Port 1 (DB25 or RJ45 connector) operating from 110 to 115,200 baud
    - Serial RS-232-C Host/Printer Port 2 (RJ45 connector) operating from 110 to 38,400 baud
    - Parallel IBM™/Centronics™ compatible printer port
  - Keyboards:
    - PC 101/102-key keyboard (RJ11 connector, standard)
    - Compact PC 101-key keyboard (mini-din connector) available
    - ANSI keyboard
    - Up to 28 shiftable and programmable edit and function keys
  - Desk Accessories:
    - Calculator capable of transmitting results
    - Monthly Calendar
    - Clock with alarm settings
    - ASCII and Diagnostic charts
    - Color Desk Accessory
-

### Vertical Mount:

1. Insert the tabs into the corresponding slots as shown (left).
2. While applying pressure on the bracket, slide the bracket toward the front of the of logic unit until it clicks into place.

### Under-Desk Mount:

1. Ensure that the bracket is securely fastened under the desk in the position shown. You may use the wood screws supplied with the bracket if the mounting surface is particle board or wood.

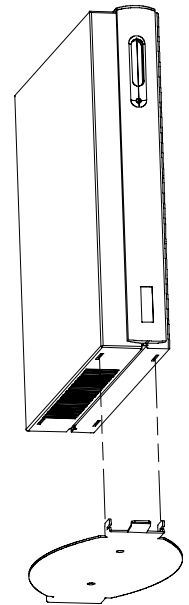
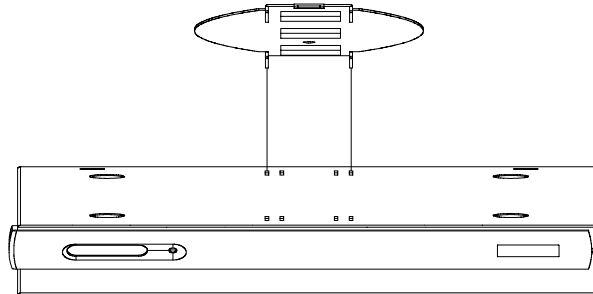

2. Position the logic unit on the bracket by directing the slots in the unit around the tabs on the bracket.
3. Press the unit firmly against the bracket and slide the unit backward until the bracket clicks into place.



**Double check that all four tabs are inside the slots in the logic unit.**

**Wall Mount:**

1. Ensure that the bracket is securely fastened to the wall in the position shown. You may use the wood screws supplied with the bracket if the mounting surface is particle board or wood.

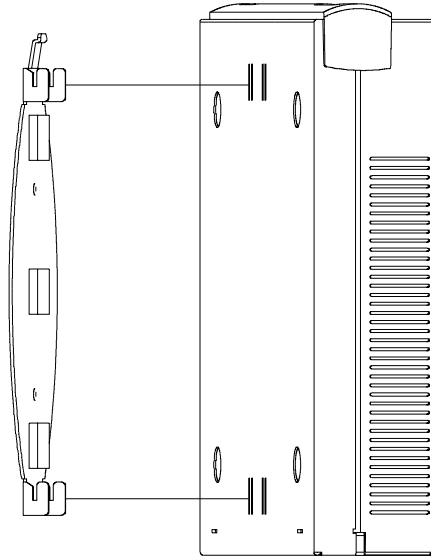

2. Position the logic unit on the bracket by directing the slots in the unit around the tabs on the bracket.
3. While pressing the logic unit towards the wall, slide the unit downwards until it clicks into place.



To order the Mounting Bracket, please quote part number 598-0005109

## Physical Features

1. **Power Switch** - press the orange button to its recessed position to turn the unit “on.” Press again to turn the unit “off.”

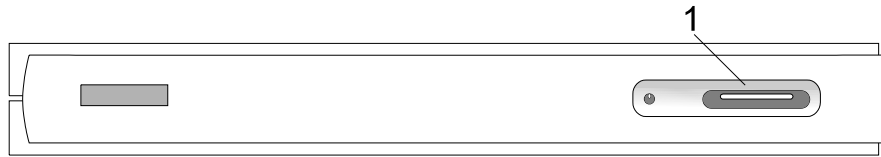

Leave the terminal’s power switch (1) in the off position “0” until power and keyboard connections are made



The Canadian Standards Association (CSA) recommends that the power outlet be near the terminal and easily accessible at all times.

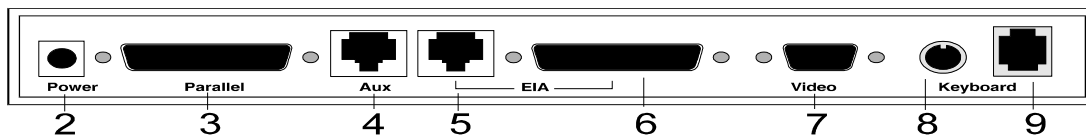

2. **Power Connection** - plug the power cord into this connector and the wall-mount or other remote transformer into a properly grounded receptacle.
3. **Parallel Printer Port** - connect the cable from the IBM or Centronics compatible parallel printer to this port. See Chapter 2 for installation options.
4. **Host/Printer Port 2 (RJ45)** - labeled “Aux” - with an RJ45 connector only, connect the cable from a second host (dual host mode) or serial printer here. See Chapter 2 for installation options.
5. **Host/Printer Port 1 (RJ45)** - labeled “EIA” - with a RJ45 connector only, connect the cable from the first host or serial printer here. Connect only one EIA port at a time. See Chapter 2 for installation options.
6. **Host/Printer Port 1 (DB25)** - labeled “EIA” - with a DB25 connector only, connect the cable from the first host or serial printer here. Connect only one EIA port at a time. See Chapter 2 for installation options.
7. **Video - Output to monitor** - attach the connector from the monitor here. The port is a DB15 female which means that a DB15 male connector is required.
8. **Keyboard Connector (mini-din)** - on a Compact PC 101-key keyboard only, line up the notch and pins of the mini-din connector and push in here. Connect only one keyboard at a time.
9. **Keyboard Connector (RJ11)** - on a PC(101/102) or ANSI keyboard, push in the keyboard connector here. Connect only one keyboard at a time.

# Keyboards

The monochrome terminal supports only the “PC-style” keyboards which include the PC 101/102-key and Compact PC 101-key keyboard.

The color terminal supports two styles of keyboards: “PC-style” and “ANSI-style” keyboards.

The keyboard layout is divided into functional key groups (as described below). The ANSI - style keyboard differs from the PC-style keyboard mainly in that it features 20 function keys, a set of PF-keys, and a different style numeric keypad. The PC-style keyboards include the PC 101-key and Compact PC 101-key keyboards.

The alphanumeric keypad is the main typewriter keypad, while the function key group lies along the top of the keyboard and can be programmed locally or downloaded from the host. The numeric keypad is the calculator-style set of keys on the right hand side of the keyboard, used in entering numeric data.

The cursor and edit keypads, located to the left of the numeric keypad. The function key group is located above the alphanumeric keypad. The communication key group, above the edit keypad, is used to control communications with the host or printer.

Each keyboard is equipped with a set of local “hot-keys”, which perform a variety of terminal functions, such as “Print Screen” and “Enter Setup”

## PC 101-key Keyboard

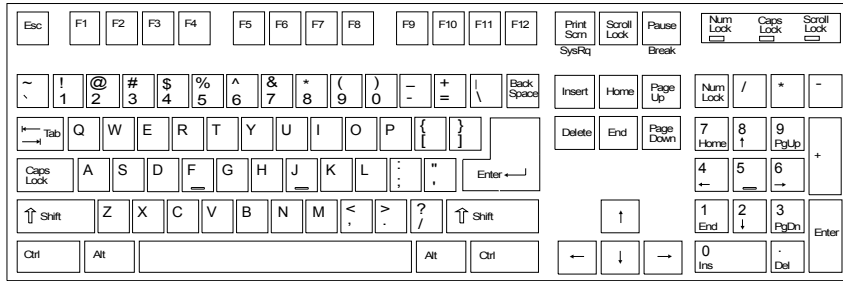

## PC 102-key Keyboard

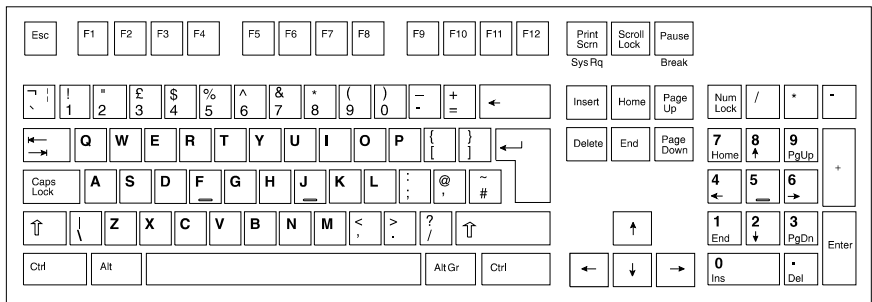

## Compact PC 101-key Keyboard

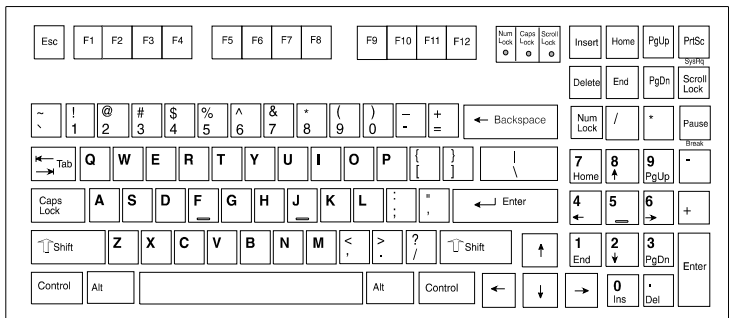

## ANSI Keyboard

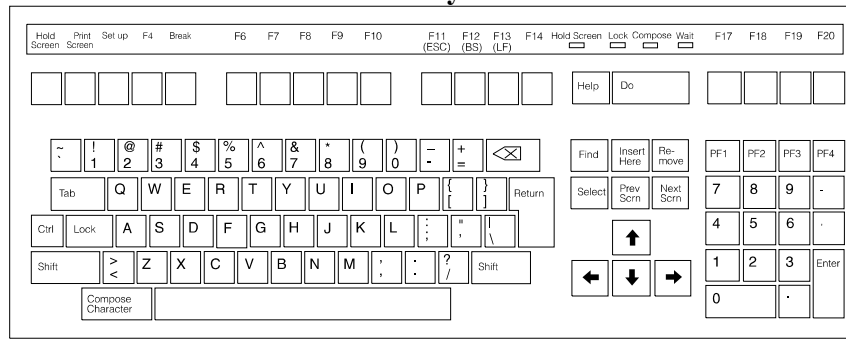

## Display Fields

The screen display shown below is a snapshot of the terminal's screen in an ASCII emulation.

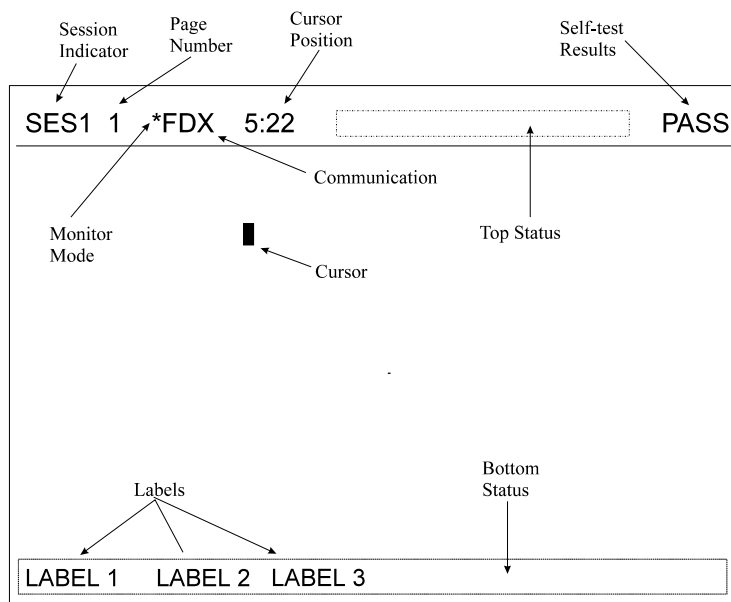









- The top line of the display is referred to as the *Top Status Line*. The Top Status Line can be disabled if desired.
- The bottom line of the display can serve as a *Bottom Status Line* in ANSI emulations or a *Function Key Label Line* for ASCII emulations.
- The *Session Indicator* displays the number of the session whose data is displayed below the Top Status Line.
- The *Page #* indicator displays the page number of the currently displayed page (except for page 0, when nothing is displayed in this field).
- The *Monitor Mode* field indicator will be present only if "Monitor Mode" is set to *On* (either through Setup or manually from the keyboard).
- The *Communication* field will display *FDX*, *HDX*, *BLK*, or *LOC* to represent the current communication mode for the session indicated by the Session Indicator.
- The *Cursor Position* indicator displays the position of the cursor in row and column numbers separated by a colon (e.g. 5:22).
- The *Self-test Result* field indicates the results (*Pass* or *Check*) of the self-diagnostic tests performed by the terminal at startup. This field is cleared with the first keystroke after power up. If the *Check* message appears, turn the terminal off and on. If the message still appears, call the technical support number listed inside of the front cover of this guide.



## Usage Notes

The following notations and symbols are used in this manual:

- **Ctrl-F1**: the two keys, **Ctrl** and **F1**, are to be pressed simultaneously.
- **Ctrl, F1**: the two keys, **Ctrl** and **F1**, are to be pressed in succession.
- **1-num** or **1-alph**: specifies that the number must be generated either from the numeric or alphanumeric keypads.
- **23h**: the number 23 is represented in hexadecimal (hex) notation.
-  applies to ASCII emulations *only*: ADDS-VP, Wyse 50+, Wyse 60, PC Term, and TVI-925.
-  applies to ANSI emulations *only*: VT300/8, VT300/7, VT200/8, VT200/7, VT100, SCO Console, and AT386.
-  applies to SCO Console and AT386.
-  applies to parallel attribute emulations *only*: includes all emulations *except* ADDS-VP, TVI 925 and Wyse 50+ (which are field attribute emulations).
-  applies to ASCII key mode only.
-  applies only to Scan Code key mode.
-  applies to the PC/+ or EPC keyboards only.
-  applies to the ANSI keyboard only.

## Communications

This terminal is equipped with three communications ports. The two serial ports are intended for connection to either a host (or modem), an alternate input device such as a scanner, or a serial printer. (The EIA port has both an RJ45 and a DB25 interface; either, but not both, can be used.) The last port is a Centronics-compatible printer port which could be used with a parallel printer or other output device (such as a cash drawer) connected to a parallel interface. The port you use as the printer port depends on whether you have a serial or a parallel interface to the printer. Another factor affecting your port selection is whether the terminal is being used in a single or dual host environment.

Either “EIA” serial port (DB25 or RJ45) can communicate with your computer or printer at a baud rate of 110 to 115,200 baud (bits per second). The second host/printer serial “Aux” port can communicate at speeds from 110 baud to 38,400 baud. Any of these ports can be used to connect to a host computer/modem or serial printer.

### Receive Flow Control

Because devices can receive data faster than they can process it, data flow control (selectable in the PORTS menu of Setup) should be used to prevent data loss. Software flow control relies on the Xon and Xoff characters (“g” and “e” characters in PC-Term mode) to indicate when the terminal is able or unable to store further data. The Xon signal transmits the DC1 character (11h) and the Xoff signal transmits DC3 (13h).

This terminal has a receive buffer capable of holding 256 bytes (or characters). When the buffer becomes half full (128 bytes), and “EIA (or Aux) Rcv” in the Setup menu for PORTS is “Xon-Xoff,” the terminal issues an Xoff character, indicating to the host that it should stop transmitting data. The terminal will then continue to process data until its receive buffer holds only 32 bytes. It will then issue an Xon character to the host, indicating that it can resume sending data to the terminal.



If the “EIA (or Aux) Rcv” is “No Protocol” in Setup, the terminal will continue to accept characters into its receive buffer until it is full. Additional characters will be lost. Xon-Xoff protocol must also be set on the host computer or printer for proper handshaking.

In addition to software “receive” flow control (Xon-Xoff), the serial host/printer ports support “receive” hardware flow control. The EIA ports have an outgoing DTR (Data Terminal Ready) signal. If the DTR signal on the terminal is low and “EIA Rcv” is “DTR” in Setup, then the serial device will stop sending to the terminal. On the AUX port, the incoming DSR (Data Set Ready) signal serves to signal the device that the terminal is not ready to receive more data, if “Aux Rcv” is “DSR” in Setup.

### Transmit Flow Control

Likewise, the terminal will understand the Xon and Xoff requests from the host when it is transmitting data (provided the “EIA (or Aux) Xmt” is “Xon-Xoff” in Setup). This is referred to as “transmit” flow control.

This terminal will stop transmitting data to the host or printer when it receives an Xoff (DC3) code. If, however, the terminal needs to send a receive protocol character, it will transmit that character even if it has received an Xoff code. When the terminal stops transmitting, the data will be buffered in the transmit buffer (64 characters for the first host/printer port and 64 characters for the second host/printer port).

Once the buffer is full, additional keyboard data will be lost. When an Xon (DC1) character is received, the terminal can again send data to the attached serial device.

In addition to software “transmit” flow control (Xon-Xoff), the serial host/printer ports support “transmit” hardware flow control, whereby DSR on the EIA port and DTR on the AUX port monitor serial devices to control the flow of data to them (provided EIA and AUX Xmit is “DSR” and “DTR” in Setup).

For parallel printers, this terminal monitors the BUSY and ERROR signals which are sent by the printer to determine when data transmission should be stopped or resumed.

### Host/Printer Port 1 (DB25)

This port, labeled “EIA,” located to the left of the video port, is designed for connection to the host (computer or modem) or a serial printer via a 25-pin D-shell (DB25P) female connector. This port uses an RS-232-C communication interface, is configured as a DTE (Data Terminal Equipment) device, and can operate from 110 to 115,200 baud. The pins supported are shown below.

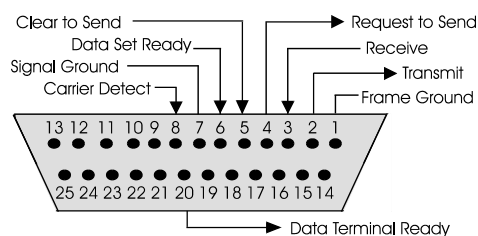



Refer to the *Installation* chapter for details on the connection of the DB25 EIA port or the RJ45 EIA port to serial devices (hosts, modems, or printers).



The optional RS-422 and current loop communications interface is only available for this DB25 EIA port.

### Host/Printer Port 1 (RJ45)

This port, labeled “EIA,” located to the right of the “Aux” port, is designed to connect to a host (computer or modem) or a serial printer and can operate from 110 to 115,200 baud. This port also uses an RS-232-C interface via an RJ45 female connector and is configured as a DTE device.

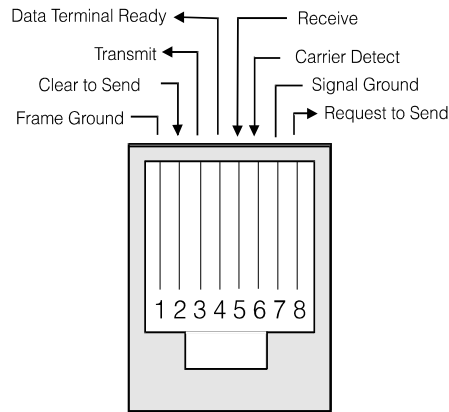

### Video Port (DB15)

The port labeled “Video” is designed to connect to the VGA monochrome or color monitor. The interface is a 15-pin, D-shell female connector. The pin assignments for this port are shown below.

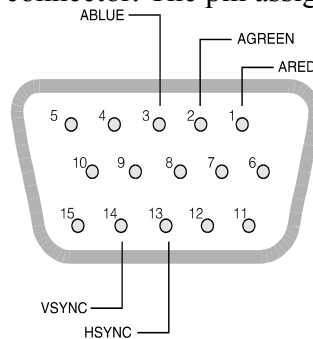

### Keyboard Ports (Mini-din or RJ11)

There are two keyboard connector ports provided. Only one keyboard should be connected at one time. The PC 101-key and ANSI keyboards will connect to the RJ11 or the mini-din interface, depending on the type of cable used. The Compact PC 101-key keyboard will connect to the mini-din port.

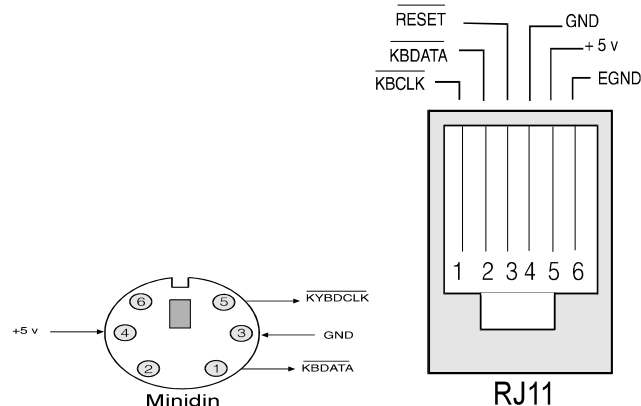

## Host/Printer Port 2

This port, labeled “Aux,” is designed to connect to a second host connection (computer or modem), a scanner or other input device, or a serial printer, and can operate from 110 to 38,400 baud. This port also uses an RS-232-C interface via an RJ45 female connector and is configured as a DCE device.

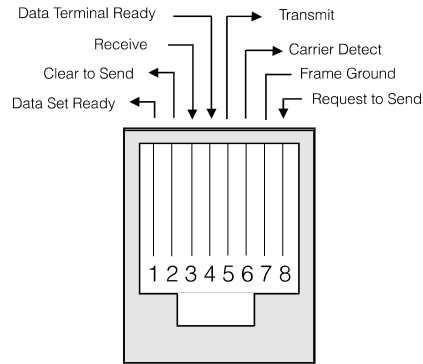

## Parallel Printer Port

This port, labeled “Parallel” is designed for connection to a parallel printer, which has a Centronics interface with a 25-pin D-shell female connector. This port, unlike the others, is a uni-directional device, which means that it only serves to output data to the printer, and cannot receive. The pins and signals supported are shown below.

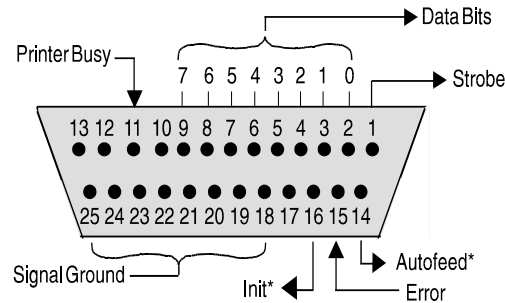

\* These signals are held high, in an inactive state.



If you have opted to use a parallel printer, but it is not connected, an error message will appear on the status line when any PRINT operation is done. To clear the message, press Ctrl-Shift-Tab.

### Terminal To Modem (or DCE Host)

Refer to the diagram below to understand why a null modem adapter may be needed when connecting the AUX serial port to a modem or a DCE host. The EIA port will connect directly without a null modem since it is a DTE device.

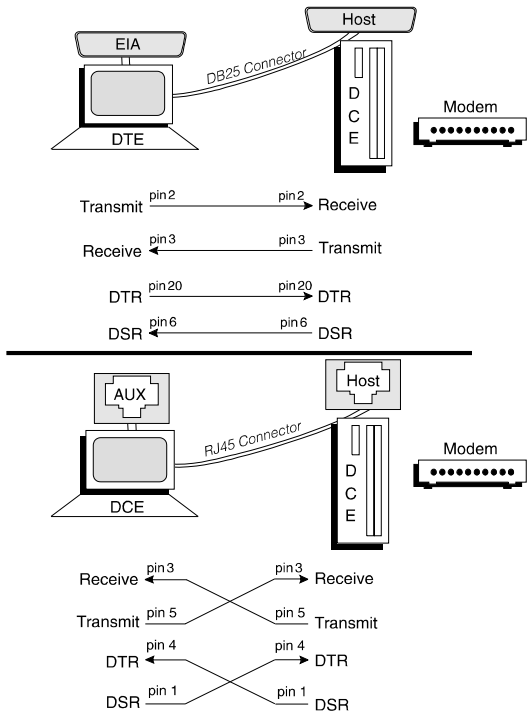

### Terminal To Host (DTE) OR Printer

Refer to the diagram below to understand why a null modem adapter may be needed when connecting the EIA serial port to a serial printer or a host port without a modem (most hosts and serial printers are DTE devices). The AUX port will connect directly without a null modem since it is a DCE device.

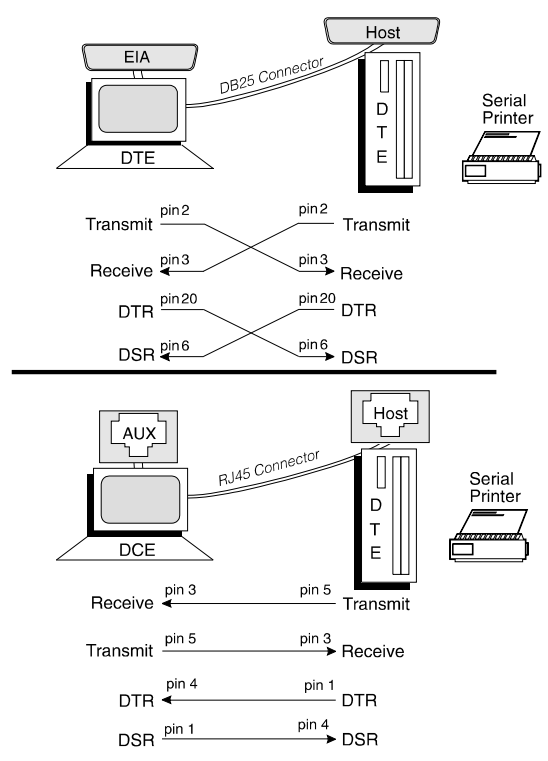

## Screen Display And Pages

This terminal offers a variety of screen lengths including 26, 44, or 49 lines. These numbers include the top and bottom status lines (or label line), as well as the lines used to display data. A “page” of terminal memory represents the total number of lines that can be accessed, whether or not they are all viewable on the screen at once. Refer to Appendix A for the number and lengths of pages available for your set-up.

The page length is comprised of a base page length multiplied by 1,2,4 or 8. For instance, in certain modes, 24 ( $24 \times 1$ ), 48 ( $24 \times 2$ ), and 96 ( $24 \times 4$ ) are available, the same way that 25 ( $25 \times 1$ ), 50 ( $25 \times 2$ ), and 100 ( $25 \times 4$ ) are. The base page length and the screen size determine whether a bottom status line or label line is displayed or not.

### Bottom Status/Label Line Display

With a screen length of “26 lines,” the page lengths that are multiples of 24 allow the bottom status/label line to be displayed, while those that are multiples of 25 do not. The same idea applies with the 44 line screen size. A page length with 42 lines as a base page size will display a label line, while the 43 line base page length will not. An exception to this rule is if the screen length is significantly larger than the base page size, then the label line will be displayed, such as if the screen is 44 lines and the page length is a multiple of 25.

The figure below represents the entire page memory of a 48 line page (24 base page length times a multiplier of 2) and the portion of the page that is viewable on the display screen, when “26 Lines” is selected. Notice that the label line is visible in this mode.

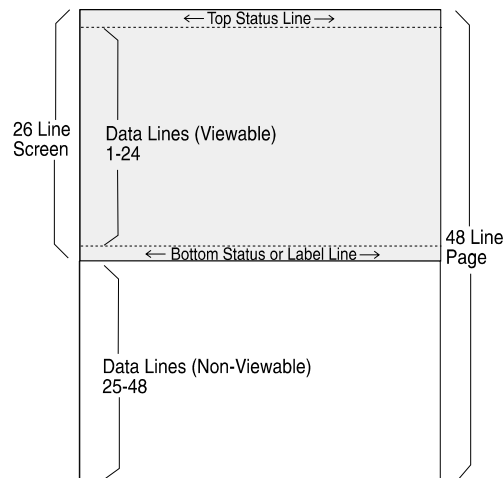

## Visual Effects Of Screen And Page Lengths

The combination of page and screen lengths influence the number of displayable data lines. For example, if the page length is "50" (25 x 2), and the screen length is 44 lines, the number of data lines that are visible at any one time is 43, with no label line. The other line is used for the top status line. On a 49 line screen, 48 of the 50 data lines are visible at one time.

If the page length is shorter than the screen length, then blank lines will be present below the data line or status/label line. If the page length is larger than the allowable number of data lines, this will cause some of the rows to be out of view. In order to bring them into view, "scrolling" or "panning" is used, as necessary. Scrolling causes a new line to scroll into view when the cursor advances past the last row or first row on the page. If the page is scrolled down, the top row of text is lost, and if scrolled up, the bottom row of text is lost (if Auto Scroll is "on" in Setup). Text scrolled off of the screen is not recoverable.

If the current page or portion of the page is longer than the screen display or window in which it is displayed, then local keystrokes can be used to "pan" the window up or down (Ctrl-i and Ctrl-Å). As a window is panned up, the page appears to be moving down and the opposite is true when panning the window down. Text that is panned off the screen is out of view, but is not lost.

The figure below represents the display screen with a 48 line page length on a 44 line screen, after panning the window down 2 lines.

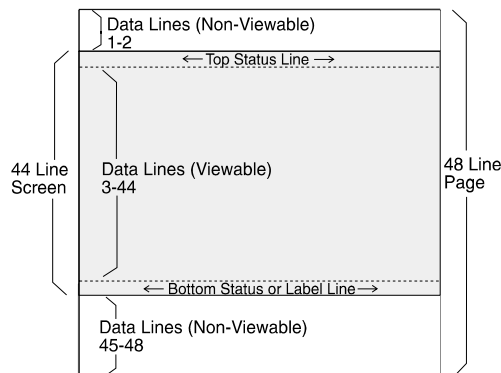

chapter

## 2

# Installation

This section provides a “walk-through” approach to the installation of your terminal. This will enable you to physically connect the terminal to a printer, one or two host computers/modems, scanner or another input device. If necessary, you will also be able to configure the Setup menu to suit your requirements and preferences.

The terminal is designed to provide great configuration flexibility. An example of this flexibility is that either the EIA or Aux port can be used to connect either to a host, another input device, or a printer. In addition, a physical port can be assigned as the Host in one session and as a Printer in the other session, if desired. In another case, data can potentially be “printed” from one session to the other. Data can be directed to the host through multiple ports, which applies when both a bar code reader and a host are attached.

The procedures described here are among the most common: conventional single and dual host setups, with or without a printer. These steps may need to be modified to meet your requirements.

## Step 1 - Physical Connections

The first step in our installation process will be to physically connect your devices to the terminal. Depending on the types of serial interfaces of your devices, you may need one or more “null modem” adapters to communicate properly.

First, refer to the *Common Set-Up* diagrams on page 21. If one of these setups matches your needs, then make the connections as shown in the diagrams by referring to the *Host/Printer Connection Guide* on page 19. Otherwise, choose the connections in the Host/Printer Connection Guide that are appropriate.



The *Common Set-Up* diagrams on page 21 show some examples of how various devices may be connected.

## Step 2 - Number Of Sessions

This step requires setting a selection in the Setup menu to configure the terminal for single or dual session mode.

If you’ve connected two host cables (steps 9A or 9C **and** 9B or 9D), and you wish to run in “dual session” mode, enter Setup and set “Sessions=Two” in the Quick (**F1**) menu. For single host operation, this setting should already be set at “One” since this is in the default state.

## Step 3 - Link Ports To Sessions

If you have selected “Sessions”=One, then you can skip to Step 4. If you have selected “Sessions”=Two, there are four designations to make. This step will be used later in Step 7.

First, you have to decide which serial port will be assigned to your first host in Session 1 (either EIA, Aux, or None). Now, decide which port will be used for your second host in Session 2 (EIA, Aux, or None). **The same port shouldn’t be used as the host port for both sessions. Also, both EIA ports cannot be used at the same time, or data loss may occur. Similarly, both keyboard ports cannot be used at the same time.** Then, determine which port will be used as the printer port in Session 1 (EIA, Aux, Parallel, None). Do the same for the printer option in Session 2. It is not general practice to assign the host port in one session as the printer port in another session, but this can be done if desired.



## Step 4 - No Printer Option

If you did not opt to install a printer (do not complete steps 9E, 9F, 9G, or 9H), you must set the Printer portion of the Host/Printer selection in the Quick (**F1**) Setup menu to “None.” Choose the combination of Host/Printer that properly represents which terminal port you are connecting the host to, and “None” as the printer.

For example, if the EIA port is connected to the host or modem, the setting would be “EIA/None.” If you are running in dual session mode, press **Ctrl-Enter** (kpd). Now, set the Printer portion of Host/Printer to “None” in Session 2, preserving the current Host setting.

## Step 5 - Determine Your Serial Port(s) Protocol

Consult your system administrator to find out the communication settings on all the serial devices you’ve connected to, including EIA (or Aux) baud, data bits, stop bits, parity, parity checking on/off, Xmt & Rcv flow control protocol. This could include one or two hosts/modems, a scanner, a serial printer, etc. Record this information on the *User Settings* chart on page 22 for reference in Step 9.

## Step 6 - Alternate Input Data Setup Selection

In single session mode only, this terminal has the option to receive data from the non-host serial port and will send the data to the host port. By default, this feature will be enabled. In Setup, “Alt Input Data” = “On” in the Host (**F7**) menu.

To disable this option, select “Off” for this parameter. If you are using a serial printer, this option is not available.

## Step 7 - Host/Printer Setup Selection

Recall the port/session designations made in Step 3. Now, enter the Setup menu (**Ctrl-Scroll Lock**) and set the “Host/Printer” selection in the Quick (**F1**) menu to the proper host and printer ports for session one. If an alternate input device is being connected (such as a scanner), the non-host serial port will be used as the second input port in the session (See Step 6).

If you are running in dual session mode, press **Ctrl-Enter** (kpd), and set the “Host/Printer” selection in the Quick (**F1**) menu to the proper host and printer ports for Session two.



Only one session can access the parallel printer at one time. If a print mode (Aux on, etc.) is on in both sessions, an error message will appear. To disable a print mode in a session, press **Shift-Scroll Lock**.

## Step 8 - Modem Control Setup Selection

If you are using a modem on either serial communications port, enter Setup and set the “(EIA) Aux Modem Control” parameter to “On” for the port(s) to ensure that proper handshaking occurs.

## Step 9 - Communications Protocol Settings

Recall the information recorded in Step 5 of this Installation procedure. In the Ports (**F6**) menu, set the proper communications settings for the ports that you are using. These parameters include (EIA and/or Aux) Baud, Data Format, Parity Check, Recv, Xmt. See the *Setup* chapter for more information on the individual settings.

Now recall the letters next to the connections that you made in Step 1. Also, you must be aware of the port/session designations made in Step 3.

The procedures below correspond directly to the individual connections made. Notice that only certain connection procedures are to be followed, not all of them. For example, if you have made connections “9C” and “9F”, to a modem and a serial printer, then follow only connection procedures “9C” and “9F” below.



Follow only those steps that apply to your connections (9A - 9H).



To access the Setup menu, press **Ctrl-Scroll Lock** on PC-style keyboards, and **F3** on ANSI-style keyboards.

### Connection A - DTE Host On EIA

1. Enter the Setup menu. If the EIA port is to be assigned to Session 1, go to step 2. Otherwise, switch sessions by pressing **Ctrl-Enter** on the numeric keypad.

2. In the Setup Quick (**F1**) menu, set the Host portion of the “Host/Printer” selection to EIA, without changing the current Printer option (“EIA/xxxx”). The Printer will be set in another connection procedure if needed.
3. In the Ports (**F6**) menu, set the proper communications settings for the EIA Baud, EIA Data Format, EIA Parity Check, EIA Recv, and EIA Xmt selections. See the Setup chapter for more detailed information on the individual settings.

### Connection B - DTE Host On Aux

1. Enter the Setup menu. If the AUX port is to be assigned to Session 2, then switch sessions (by pressing **Ctrl-Enter** on the numeric keypad). Remain in session 1, if it is to be assigned to that session.
2. In the Setup Quick (**F1**) menu, set the Host portion of the “Host/Printer” selection to Aux, without changing the current Printer option (“Aux/xxxx”). The Printer will be set in another connection procedure if needed.
3. In the Ports (**F6**) menu, set the proper communications settings for the “Aux Baud”, “Aux Data Format”, “Aux Parity Check”, “Aux Recv”, and “Aux Xmt.” See the *Setup* chapter for more information on the individual settings.

### Connection C - DCE Host/Modem On EIA

1. Follow procedure described in Connection A.
2. If you are connecting to a modem, the Ports (**F6**) menu, set the “EIA Modem Control” parameter to On.

### Connection D - DCE Host/Modem On Aux

1. Follow procedure described in Connection B.
2. If you are connecting to a modem, in the Ports (**F6**) menu, set the “Aux Modem Control” parameter to On.

### Connection E - Serial Printer On EIA

1. In the Setup Quick (**F1**) menu, set the Printer portion of the “Host/Printer” selection to EIA, without changing the current Host option (“xxxx/EIA”). The Host will be set in another connection procedure if needed.
2. Follow procedure described in step 3 of connection A.

### Connection F - Serial Printer On Aux

1. In the Setup Quick (**F1**) menu, set the Printer portion of the “Host/Printer” selection to Aux, without changing the current Host option (“xxxx/Aux”). The Host will be set in another connection procedure if needed.
2. Follow procedure described in step 3 of Connection B.

### Connections G & H - Serial Or Parallel Printer On Parallel

1. Enter the Setup menu. If the parallel port to be assigned to Session 2, then switch sessions (by pressing **Ctrl-Enter** on the numeric keypad). Remain in session 1, if it is to be assigned to that session.
2. In the Setup Quick (**F1**) menu, set the Printer portion of the “Host/Printer” selection to Para, without changing the current Host option (“xxxx/Para”).
3. Repeat this procedure if the parallel port is going to be used to print from both sessions.



Only one session can access the parallel printer at one time. If a print mode (Aux on, etc.) is On in both sessions, an error message will appear. To disable a print mode in a session, press **Shift-Scroll Lock** on PC-style keyboards, and **Shift-F3** on ANSI-style keyboards.

## Step 10 - Emulation Setup Selection

This step requires setting a selection in the Setup menu to configure the “Emulation” for one or two sessions of the terminal. Determine which emulations your applications run with.

Enter the Setup menu and set the “Emulation” parameter, in the Quick (**F1**) menu, to match your requirements. If you are running in dual session mode, press **Ctrl-Enter** (kpd). Now, set the “Emulation” parameter in Session 2.

## Step 11 - Additional Setup Options

At this point, you should proceed to the Setup chapter and continue to set up your own selections for any other parameters such as those for the display, keyboard, function/edit keys and tabs.

Remember to repeat this procedure for Session 2 if you are running in dual session mode. Use **Ctrl-Enter** (kpd) to access this set of parameters.

## Step 12 - Save Parameters

Finally, remember to save your Setup parameters in permanent memory, so that they can be recovered if the terminal is powered down. When you exit the Setup menu, the prompt “Save all? (Y/N)” flashes. To save parameters, press “Y.” Another way to save parameters is to perform a “Save Terminal” operation, while in the Exec (Prt Sc) menu of Setup. Both methods will save the parameters in both sessions, as well as those that are common to both.



Remember to save your Setup settings after the entire installation process.

## Step 13 - Establish Communications

1. Your installation is now complete. By pressing the Return or Enter key, you should be able to communicate with the host computer(s). The printer should respond to the local print command, **Shift-Ctrl-.** (kpd); use the period on the numeric keypad.
2. If for some reason, your installation was not successful, make sure your physical connections are secure, that the communications protocol settings match your devices and that the Setup selections are chosen to provide a proper interface between the terminal and your devices.
3. If you continue to have problems installing the terminal, call your local dealer for technical support.

## Host/Printer Connection Guide



**CAUTION:** Do not (un)plug in electrical storm.

	SES1-EIA (DTE)	SES2-AUX (DCE)	PAR
<b>DTE Host*</b> 	<p><b>Connection A:</b> Connect a null modem adapter between the host cable and the EIA port.</p>	<p><b>Connection B:</b> Connect the host cable directly to the AUX port.</p>	<p>Not applicable.</p>
<b>DCE Host or Modem</b> 	<p><b>Connection C:</b> Connect the host or modem cable directly to the EIA port.</p>	<p><b>Connection D:</b> Connect a null modem adapter between the host or modem cable and the AUX port.</p>	<p>Not applicable.</p>

**NOTE**

\* Most host computers are configured as a DTE device. The Mentor® System is an example of a DCE host system.

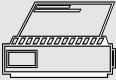
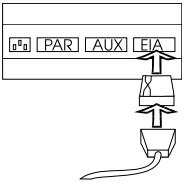
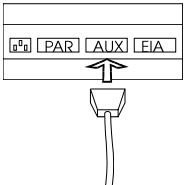
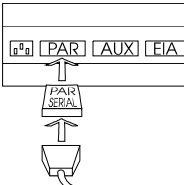
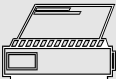
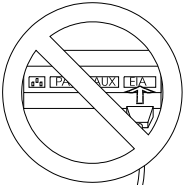
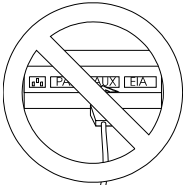
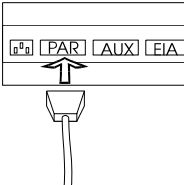
	SES1-EIA (DTE)	SES2-AUX (DCE)	PAR
<b>DTE Serial Printer**</b> 	 <p><b>Connection E:</b> Connect a null modem adapter between the serial printer cable and the EIA port.</p>	 <p><b>Connection F:</b> Connect the serial printer cable directly to the AUX port.</p>	 <p><b>Connection G:</b> This is an option if you connect a parallel-to-serial converter between the serial printer cable and the PAR port.</p>
<b>Parallel Printer (Centronics/IBM)</b> 	 <p>Not applicable.</p>	 <p>Not applicable.</p>	 <p><b>Connection H:</b> Connect the parallel printer cable to the PAR port.</p>

NOTE

\*\* Most serial printers are configured as DTE devices.

# Common Setups

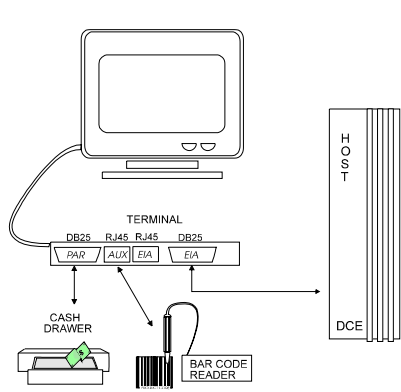

**Sessions=One**  
**Host/Printer=EIA/Para**  
**Aux Baud, Aux Data Format, etc.** matches the host, and aux. device.  
**Alt Input Data=On**

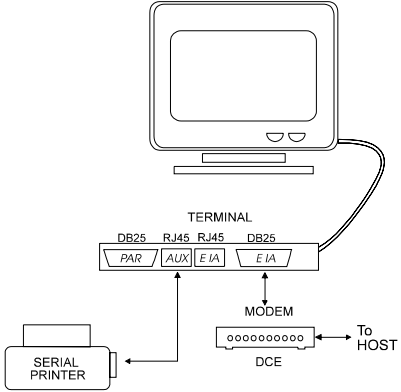

**Sessions=One**  
**Host/Printer=EIA/Aux**  
**EIA Baud, etc.** matches the host  
**Aux Baud, etc.** matches the printer  
**EIA Modem Control=On**

\* The Aux port can be configured as a DTE device or a null modem can be used.

\* A null modem should be used when connecting the EIA port to a DTE device.

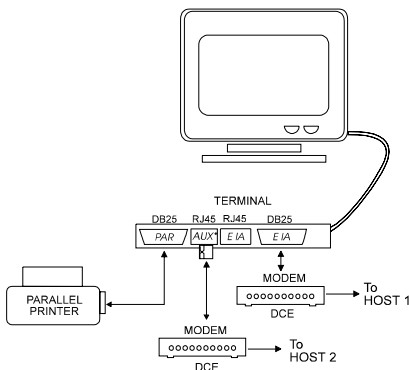

**Sessions=Two**  
**Session1 Host/Printer=EIA/Para**  
**Session2 Host Printer=Aux/None**  
**EIA Baud, etc.** matches host 1  
**Aux Baud, etc.** matches host 2

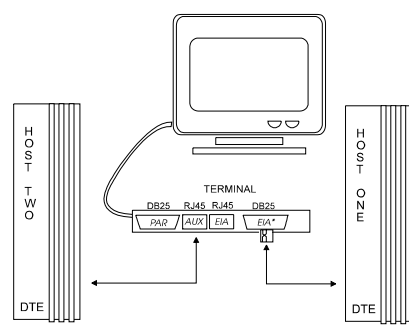

**Sessions=Two**  
**Session1 Host/Printer=EIA/Para**  
**Session2 Host Printer=Aux/Para**  
**EIA Baud, etc.** matches host 1  
**Aux Baud, etc.** matches host 2  
**EIA Modem Control=On**  
**Aux Modem Control=On**

## User Settings

Use the chart below to document your system and terminal settings:

Parameters	Examples:	Your Settings:
Number of sessions Host/Printer (Session 1)* Host/Printer (Session 1)* Emulations (Session 1) Emulations (Session 2)	2 EIA/Para Aux/None ADDS-VP VT-300-8	
Host 1: Baud Data Bits Stop Bits Parity Parity Check Flow Control (In)** Flow Control (Out)*** Modem Control	9600 8 1 None Off Xon-Xoff Xon-Xoff On	
Dual Host mode only, press <b>CTRL-Enter</b> (kpd): Host 2: Baud Data Bits Stop Bits Parity Parity Check Flow Control (In)** Flow Control (Out)*** Modem Control	19200 7 2 Odd On DTR (or DSR) DTR (or DSR) Off	

Notes: \* In most cases, these parameters should not be the same.

\*\* Incoming flow control on the host should correspond to "EIA (or Aux) Rcv."

\*\*\* Outgoing flow control on the host should correspond to "EIA (or Aux) Xmt."

chapter

## 3

# Setup

The Setup menu is your control panel for this terminal. It permits you to configure the terminal to communicate with the host computer as well as to suit your personal preferences.

## Overview

The Setup menus have been designed to allow maximum flexibility with a minimum investment of time. Thirteen menus provide you with the flexibility and the features below contribute to ease of use:

- The Quick menu is the first screen upon entry. It contains the parameters critical to the operation of the terminal with the host.
- Function keys permit easy access to any menu. The function keys are labeled at the top of every menu.
- Setup is “smart.” That is, it provides only the options that are valid for the hardware and current emulation.
- Keystrokes and Help Messages are at the bottom of every menu.
- Valid choices for the selected parameter are displayed at the bottom of the menu.

## Entry And Exit



PC Keyboard:

- Press **Ctrl-Scroll Lock** to both enter and exit setup. Also, press **F14** or **Pause** key to exit.



ANSI Keyboard:

- To enter, press **F3** (when Setup selection “F1 to F5 keys” = Local)
- To enter, press **Ctrl-F3** (when Setup selection “F1 to F5 keys” = Fkey)
- To enter, press **Ctrl-Select** (when Setup selection “Key Mode” = Scan Code)
- To exit, press **Ctrl-Select** twice (when n Setup selection “Key Mode” = Scan Code and “local Leadin” = On).
- To exit, press **F14**.

## Printing

To print the settings of the Setup menu, press **Ctrl-shift-** (period on the numeric keypad). The output of this print command is directed to the port specified by the “Host/Printer” selection in the Quick (**F1**) menu. If the “Printer” portion of this parameter is set to None, the output is forwarded to the parallel port.

## Saving Parameters

Upon exiting setup mode, the prompt “Save All (Y/N)” appears on the top right portion of the screen.

- Press **Y** or **y** to exit setup and save settings in permanent memory.
- Press **C** or **c** to cancel the exit request.
- Press any other key to exit setup. The changes will take effect, but will be lost if the terminal is reset or powered off.





An exception to this is function/edit key and answerback message programming. Once edited in Setup, the changes are saved regardless of the way in which you exit Setup.

## Movement Inside Menus

**F1 through F12** - Select the menu that corresponds to the function key. The Print Scrn key is available to access the “EXEC” menu. These keys are always active within Setup. The keys are labeled at the top of each menu.

**Cursor control keys** (↑←↓→) - These keys control movement to parameters within the menu and is indicated by a highlighted selection bar. This selection bar will wrap to the other side of the menu at the top, bottom and side boundaries. For each parameter, there are at least two choices. As the parameter is highlighted, the available choices appear in the area above the help bar.



Some parameters are action fields and have no choices. See the *Action Fields* section below.

- **Enter and Shift-Enter** - Cycle “up” or “down” through the choices for a given parameter.



The following keystrokes are also available but are not documented in the Setup help bar.

- **Tab and Shift-Tab** - Move from menu to menu forward or backward without using function keys.
- **Space and Shift-Space** - Cycle through the list of choices. Same as Enter and Shift-Enter.



Parameters are changed and executed as soon as that field is exited. Page resets may occur when certain choices are made in Setup, and the screen will temporarily become blank while the terminal processes.

## Action Fields

Certain parameters are not selections but action fields. When the action field is highlighted and then selected, the action is taken. A “WAIT” message may appear at the top right portion of the screen, and when the action is completed, a “DONE” message will appear. These messages are cleared when the selection bar is placed on another parameter.

## Dual Session Mode

There are two “sets” of “session” setup parameters, if you are using the terminal in dual session mode. To toggle between sessions while in or out of setup mode, press **Ctrl-Enter** (kpd). For a complete explanation of session-dependent and terminal-dependent parameters, see page 39.

## Setup Map

Key	Menu	Parameters Available		
		(Not all will display for a given emulation, keyboard, or video mode)		
F1	Quick	Emulation	Comm Mode	EIA Baud Rate
		Aux Baud Rate	Enhanced	EIA Data Format
		Aux Data Format	Language	Sessions
		Host/Printer		
F2	General	Emulation	Enhanced	Auto Wrap
		Auto Font Load	Auto Page	Auto Scroll
		Monitor Mode	Screen Saver	Bell Volume
		Warning Bell	Host/Printer	Sessions
		Session Display	Color Mode	
F3	Display	Page Length	Screen Video	Cursor
		Display Cursor	Scroll	Palette Number
		Columns	Width Change Clear	Auto Adjust Cursor
		Screen Length	Speed	Scroll Speed
		Refresh Rate	Erase Color	
F4	Keyboard	Language	Key Repeat	Keyclick
		Margin Bell	Key Mode	Char Set Mode
		Key Lock	Key Rate	
F5	PC Keys	Enter Key	Return Key	Backspace
		Alt Key	Pound Key	Local Leadin
		Return Key Repeat	Desk Acc	Disconnect
	ANSI Keys	Enter Key	Return Key	DEL key
		Compose key	Pound Key	Local Leadin
		Return Key Repeat	F1 to F5 keys	Disconnect
		.. and ,, key	' and ~	<> Key
F6	Ports	EIA Baud Rate	EIA Data Format	EIA Parity Check
		Aux Baud Rate	Aux Data Format	Aux Parity Check
		EIA Xmt	EIA Recv	EIA Xmt Pace
		Aux Xmit	Aux Recv	Aux Xmt Pace
		EIA Break	EIA Modem Control	EIA Disconnect
		Aux Break	Aux Modem Control	Aux Disconnect

F7	Host	Comm Mode	Local	Recv <CR>
		Recv <DEL>	Send ACK	Send Line Term
		Send Block Term	Send Region	Send End
		Null Suppress	Alt Input Data	
F8	Print	Prt Line Term	Prt Block Term	Prt Region
		Prt Mode	Secondary Recv	
F9	 Emulation	Attribute	Bright Video	Enhanced Attributes
		Page Edit	WPRT Intensity	WPRT Reverse
		WPRT Underline	WPRT Blink	Display NV Labels
		Save Labels	Char Set	Status Line
		Fkey Speed		
	 Emulation	Numeric Kpd	Cursor Kpd	Send Data
		Print	ANSI-ID	Function Key Lock
		Key Usage	UPSS	Feature Lock
		Char Set	Status Line	
F10	Tabs	Auto Init Tabs	Default Tabs	
F11	Answerback	Answerback Mode	Answerback Conceal	
F12	Program	Key	Program	Key Dir
Prt Sc	Execute	Save Terminal	Recall Terminal	Default Terminal
		Save Session	Recall Session	Default Session
		Reset Terminal	Reset Session	Reset Ports
		Clear Screen	Default Session UDKs	
Pause	Exit Setup	Save all? (Y/N)		

## Quick: F1

F1 Quick	F2 Genrl	F3 Disp	F4 Kybd	F5 Keys	F6 Ports	F7 Host	F8 Print	F9 Emul	F10 Tabs	F11 AnsBk	F12 Prog	F13 Exec
<b>Parameters</b>												
<b>Emulation = Wyse-60</b> Aux Baud Rate = 9600 Aux Data Format = 8/1/N Host/Printer = EIA/Para			Comm Mode = Full Duplex Enhanced = On Language = U.S.				EIA Baud Rate = 9600 EIA Data Format = 8/1/N Sessions = One					
<b>Choices</b>												
ADDS-VP <b>Wyse-60</b> Wyse-50+   PC-Term   VT-300-7   VT-300-8   VT-200-7 VT-200-8   VT-100   SCO-Console												
<b>Select</b>												
↑→↓← : Parameter				Enter/S-Enter: Next/Prev Choice				Exit: F14				

**Emulation:** ADDS-VP, **Wyse-60**, Wyse-50+, PC-Term, VT-300-7, VT-300-8, VT-200-7, VT-200-8, VT100, SCO Console, AT386, TVI925, Wyse-325, **Wyse-350**, Intercolor]

Select the “personality” of the terminal (the way in which it responds to commands). If you are using PC-Term emulation, refer to Local Leadin selection on page 31 for access to local “hot keys.”



Wyse-325, **Wyse-350**, and Intercolor emulations available only in 260lfc.



All associated defaults are loaded when the emulation is changed. Default choices are in bold. Some defaults may vary depending on the selected emulation.

**Comm Mode:** [Full Duplex, Half Duplex, Full Block, Half Block]

Select the method of communication to match the host computer.

**EIA Baud Rate:** [115,200, 76800, 57,600, 38400, 19200, **9600**, 4800, 2400, 2000, 1800, 1200, 600, 300, 150, 110]

Select the number of bits communicated per second to match the speed at which the primary host, printer or other device expects to communicate.

**AUX Baud Rate:** [38400, 19200, **9600**, 4800, 2400, 2000, 1800, 1200, 600, 300, 150, 134.5, 110]

Speed at which the secondary host, printer, or other device expects to communicate.

**Enhanced:** [On, Off]

Normally, the terminal responds to a set of commands that correspond to the emulation selected. When Enhanced mode is *on*, the set of commands is extended to those printed in boldface in the *260xx Programmer's Reference Guide*.

**EIA Data Format:** [7/1/N, 7/1/O, 7/1/E, 7/1/M, 7/1/S, 7/2/N, 7/2/O, 7/2/E, 7/2/M, 7/2/S, **8/1/N**, 8/1/O, 8/1/E, 8/1/M, 8/2/N, 8/2/O, 8/2/E]

Select a data bits/stop bits/parity combination which matches the data format of the primary host, printer or other device. Parity abbreviations are: O = odd, E = even, S = space, M = mark, and N = none.

**AUX Data Format:** [7/1/O, 7/1/E, 7/1/M, 7/1/S, 7/2/N, 7/2/O, 7/2/E, 7/2/M, 7/2/S, **8/1/N**, 8/1/O, 8/1/E, 8/1/M, 8/1/S, 8/2/N]

Select a data bits/parity bits/stop combination which matches the data format of the secondary host, printer or other device. Parity abbreviations are: O = odd, E = even, S = space, M = mark, and N = none.

**Language:** [**U.S.**, U.K., Danish, Finnish, French, German, Norwegian, Portuguese, Spanish, Swedish, Dutch, Belgian-Flemish, French-Canadian, Italian, Latin American, Swiss-French, Swiss-German]

Select the language type which matches your keyboard's layout.

**Sessions:** [One, Two]

Select the number of sessions that the terminal will run. One session is required per connection to a host. When two sessions are selected, the Setup menu will display the message “Press Ctrl-Enter Kpd to Toggle Sessions” at the bottom of the screen. The current session is displayed at the upper left corner of the status line (either by a SES1 or SES2 indicator). To change the active session, press Ctrl and Enter on the numeric keypad simultaneously.

**Host/Printer:** [EIA/Aux, **EIA/Para**, EIA/None, Aux/EIA, Aux/Para, **Aux/None**, None/EIA, None/Aux, None/Para, None/None]

The first part of the selection indicates the host (either the EIA port or the AUX port) and the second part of the selection indicates the printer port (if a serial printer is used, either the EIA or Aux port can be used to connect to the printer, but if a parallel printer is being used, the PAR port should be used.) The active session “drives” the printer. EIA/Para is the default for Session 1, and Aux/None is the default for session 2.

## General: F2



This chapter lists all possible parameters for each menu, and all possible choices for each parameter. Depending on the emulation selected, the keyboard type, and the key mode (ASCII or ScanCode), Setup will only present the valid set of parameters and choices in each menu.

**Emulation:** select the “personality” of the terminal. See the Quick menu on page 27.

**Enhanced:** Choose whether the terminal can respond to commands beyond the limitations of the current emulation. See the Quick menu on page 27.

**Auto Wrap:** [On, Off]

Select whether the cursor drops to the next line when it reaches the right margin or continues to display characters at the right margin. In ANSI emulations, the default is *off*.

**Auto Font Load:** [On, Off]

S select whether the four font banks (0-3) should automatically be loaded when screen size or the emulation is changed.

**Auto Page:** [On, Off]

When the cursor is moved off the page using a command that includes scroll and Auto Page mode is *on*, the screen displays the new page. These pages are numbered from 0 to a maximum of 3. When *on*, Auto Page will track the page even if Auto Scroll is off. The up-arrow key does not have a scroll command embedded, so it cannot be used to view the previous page even when Auto Page is *on*.

**Auto Scroll:** [On, Off]

Choose whether the terminal updates the display when the cursor is moved beyond the boundaries of the currently viewed screen.

**Monitor Mode:** [On, Off]

Choose whether control codes will be displayed as their graphic representations or be acted upon as terminal/cursor commands.

**Screen Saver:** [Off, 2 min, 5 min, 15 min, 30 min]

Select whether the screen will go blank after lack of activity from the keyboard or the host of the selected period of time. The first key typed at the keyboard when the screen is blank will reactivate the display. The key code will not be transmitted to the host. The *Caps Lock LED* will flash while Screen Saver is active.



Use screen saver to prevent “phosphor burn” on the screen when the display on the terminal is left unchanged for an extended time period.

**Bell Volume:** [0, 1, 2, 3, 4, 5, 6, 7, 8, 9]

Select the bell volume from of [0] to high [9]. This will be the volume for alarm tones, warning bells, and key clicks.

**Warning Bell:** [On, Off]

Select whether a warning bell is sounded when errors (such as an invalid compose sequence) are encountered.

**Host/Printer-** Designates physical ports to the host and printer for the selected session. See the Quick menu on page 27.

**Color Mode:** [Palette, Direct, Auto]

Select the type of color mapping used by the current emulation:

- In *Palette* mode, visual attributes and their combinations (such as bold, underline, etc.) are displayed as specific color combinations defined in the current palette. The current palette may be one of sixteen pre-defined and two soft (downloadable) palettes. See the *260xx Programmer's Reference Guide* for more information.
- In *Direct* mode, colors and visual attributes are directly controlled by the SGR (Select Graphics Rendition) command. See the *260xx Programmer's Reference Guide* for more information.
- In *Auto* mode, the terminal will switch between Direct and Palette modes depending on the color commands received from the host. Colors and attributes are then displayed according to the currently active mode.

**Sessions:** [One, Two]

Select the number of sessions (hosts) that the terminal will run. See the Quick menu on page 27.

**Session Display:** [Full, Split]

When two sessions are used, select whether each host's data displays on a full screen or if both hosts share a split screen. In either case, the way to toggle between the hosts is by using **Ctrl-Enter** (kpd). Both hosts can receive and update data simultaneously. The purpose of toggling is so that keyboard entry can be directed to the selected host. In the case of a full display, toggling also brings the entire display of the selected host into view.

## Display: F3

**Page Length:** [24, 25, 42, 43, 48, 50, 84, 86, 96, 100, (168), (172), (192), (200), \*24, \*25, \*42, \*43]

Select the number of lines per page. As many as four pages (0-3) may be available, but the number of pages in memory depends on the memory/page configuration, number of lines per page, the firmware version, the type of emulation, and whether 80-Only is selected for columns. The total lines used (Lines/Page x # of Pages) will not exceed 218. See *Page Configurations* in *Appendix A*.

Page lengths which are multiples of 24 or 25 and those that are multiples of 42 or 43 are displayed by default on a 26-line or 44-line screen, respectively. The extra one or two lines on the screen can be used as status lines.

The selections shown in ( ) are not available in dual session mode. If a page length which is preceded by an asterisk (\*24, \*25, \*42, or \*43) is selected, the total number of pages will be two, where the first page contains the number of lines in the selection (24,25,42, or 43) and the second page contains the remaining allowable lines. (See *Appendix A*.)

In SCO Console emulation, the default is 25.

**Screen Length:** [26 Lines, 44 Lines, 49 Lines]

Select the number of lines that can be displayed on the screen at one time. The page length affects the default number of lines.

**Screen Video:** [Normal, Reverse]

Choose between bright characters on a dark background (normal) and dark characters on a bright background (reverse). In reverse video mode only, the “Enhanced Attributes” parameter is available. (See page 35.)

**Display Cursor:** [On, Off]

Choose whether the cursor will be displayed.

**Cursor:** [Blink Block, Steady Block, Blink Line, Steady Line]

Choose the appearance of the cursor.

**Auto Adjust Cursor:** [On, Off]

Select whether the screen attempts to follow the cursor down the page by scrolling just enough to keep the cursor in view.

**Columns:** [80, 132, 80-Only]

Choose the number of columns that the screen can display. 80-Only provides more pages in memory for a given page length by disallowing changes to 132-column display.

**Width Change Clear:** [On, Off]

Select whether the screen is to be cleared when the number of columns on the screen is changed from 80 to 132 or vice versa. This selection is only visible when the Columns selection is 132.



Changing columns from/to 80-only forces the screen to clear independent of Width Change Clear.

**Speed:** [Fast, Normal]

Selecting fast improves the speed at which screen display occurs at the expense of minor, temporary distortion of text called “tearing.”

**Scroll:** [Jump, Smooth]

Choose whether the data on the screen scrolls smoothly or “jumps” to accommodate data at the rate it is received.

**Scroll Speed:** [Smooth 1, Smooth 2, Smooth 4, Smooth 8]

Select the number of scan lines per second the page scrolls up when smooth scroll is selected. Smooth 1 is the slowest rate and Smooth 8 is the fastest. This selection is only visible when Scroll is set to *smooth*.

**Erase Color:** [Black, Background]

This parameter selects the color of all new areas (spaces or text) introduced to the screen by an erase, insert or scroll command.

**Palette Number:** [0, 2, 3,..., 15, Soft 1, Soft 2]

Select the palette used in color and attributes mappings. There are 16 pre-defined palettes and 2 soft palettes available to all emulations except Wyse 60 and Wyse 325 which have 10 pre-defined palettes and 2 soft palettes. this parameter is present in all ANSI emulations only when “Color Mode” in General (F2) menu is set to Palette.

Soft Palettes are used to save a set of user-defined color combinations. To define your preferred color combinations, select a soft palette and alter the color settings using the Color Utility Desk Accessory (see Chapter 4). To save your selections, select “Save Terminal” or “Save Session” from the Exec (F13) menu of Setup.

## Keyboard: F4

**Language:** [US, U.K., Danish, Finnish, French, German, Norwegian, Portuguese, Spanish, Swedish, Dutch, Belgian-Flemish, French-Canadian, Italian, Latin-American, Swiss-French, Swiss-German]

Choose the language that matches the keyboard.

**Char Set Mode:** [PC, ANSI, ASCII]

Choose character sets used for 20-7Fh (GL) and A0-FFh (GR). In VT emulations, the default is *ANSI*. The table below can be used to determine which sets are loaded for each mode, depending on “Char Set Mode” and “UPSS” (in the Emul (F9) menu).

Char Set Mode (F4 menu)	Char Set (F9 menu)	Language	Default Character Set	
PC	GL	Multinational	Any	ANSI Standard
		National	Any	PC-NRC
	GR	Multinational	US or UK	PC-Multinational
			French Canadian	PC French Canadian
National	Norwegian	PC Norwegian		
	All others	PC Multinational		
ANSI	GL	Multinational	Any	ANSI Standard
		National	Any	ANSI-NRC
	GR	Multinational or National	Any	PC-Multinational
			Any	PC-Multinational
ANSI	GL	Multinational	Any	ANSI Standard
		National	Any	ANSI-NRC
GR	Multinational or National	Any	Any	ISO-Latin/ANSI Supp
		Any	Any	ISO-Latin/ANSI Supp

**Key Mode:** [ASCII, ScanCode]

Select whether keys transmit ASCII codes or the ScanCode. The ScanCode transmits a “make code” when a key is pressed and a “break code” upon its release. When *ScanCode* is selected, “Comm Mode” is forced to *Full Duplex* and “Character Set” is forced to *Multinational* (8-bit).

**Keyclick:** [On, Off]

Choose whether pressing a key results in a clicking sound. The default is off in SCO Console emulation.

**Key Repeat:** [On, Off]

Choose whether keys, including function keys, will repeat when pressed for more than half a second. This setting does not affect the following keys on the keyboard:



Caps Lock, Scroll Lock, Num Lock, Shift keys, Ctrl keys, Alt keys, Return, Print Screen, Pause.



Lock, F1-F5, Shift keys, Control, Compose, and Return.

**Key Rate:** [15 cps, 20 cps, 30 cps]

When “Key Repeat” is on, a key that is pressed for more than half a second will automatically repeat. This selection allows you to choose the number of characters that are generated per second when a key is auto repeating.

**Margin Bell:** [On, Off]

Choose whether a bell tone sounds when the cursor is nine positions away from the right margin.

**Key Lock:** [Caps, Reverse, Shift]

- this setting affects the state of alphanumeric keys when **Caps-Lock** is *engaged*.

- **Caps** causes alphabetic keys to be uppercase regardless of the **Shift** key.
- **Reverse** means that pressing the **Shift** key will generate lower-case alphabetic keys.
- **Shift** causes all alphanumeric keys to be generated as uppercase (or shifted, in the case of numbers). If the **Shift** key is hit, while Shift is selected, **Caps-Lock** will be *disengaged*.

## Keys: F5

**Enter Key:** [CR, CR-LF, TAB]



Select the code the enter key in the numeric keypad transmits.

**Return Key:** [CR, CR-LF, TAB]

Select the code the return key on the main alphanumeric keypad transmits.

**Alt Key (left):** [Meta, Legend, Funct, Scroll-Lock, Alt Key]

Select the way in which the left **ALT** key behaves. In ANSI emulations, *Compose* is available as a selection instead of *Legend*. The **Alt Key** selection refers to the right **Alt** key.

- **Meta** sets the most significant bit for the next character and allows 8-bit data to be generated from the keyboard.
-  Legend precedes a key from the keyboard and causes the character that is printed on the right-side of the key to be sent to the terminal or host.
-  Compose precedes sequences of keys to create a character that is not on the keyboard but is available in the active character set.
- **Scroll Lock** causes the Alt key to function as the Scroll Lock key, and is a toggle to hold/free data on the screen. It requires the use of flow control for the host port "Rcv Prtcl".
- **Funct** causes the Alt key to function as the **Funct** key on an ASCII keyboard.
- **Alt Key** causes the left **Alt** key to behave identically to the right **Alt** key.

**Pound Key:** [U.S., British]

Choose the character transmitted for 23h: the US pound (#) or the British pound (£).

**Return Key Repeat:** [On, Off]

Select whether the Return key located on the alphanumeric keypad will repeat when held down for more than half a second (only selectable when "Key Repeat" = *On*).

 **Local Leadin:** [On, Off]

This parameter is only available when Key Mode (in the Kybd menu) is *ScanCode*. If Local Leadin is *off*, the only local function (*Appendix A*) that is available is **Ctrl-Scroll Lock** to enter Setup. If Local Leadin is *on*, the Setup keystroke "introduces" the keystroke as local and then local functions can be generated using the keystrokes listed on page A-1. For example, to enter Setup when ScanCode and Local Leadin are *on*, press **Ctrl-Scroll Lock** to introduce this as a local function, and then **Ctrl-Scroll Lock** to enter Setup.



Local Leadin will not work if Comm Mode is set to Half Block or Full Block.



### PC Keyboard

**Disconnect:** [Disabled, Pause, Alt-Pause]

Select the keystroke that will generate a modem disconnect.

**Backspace:** [BS/DEL, DEL/BS, DEL/CAN, BS/BS]

Choose the codes sent by the backspace key in the normal/shifted positions.

**Desk Acc:** [Sh-Ctrl-Fkeys, Ctrl ←, Disabled]

Select how the Desk Accessories can be accessed. This selection does not appear when SCO Console emulation is selected. In SCO Console emulation, **Ctrl ←** is the only access method.

The default allows the desk accessories to be accessed through a menu which appears when **Ctrl** and the **left arrow** key are pressed simultaneously. This brings up a pop-up window; selections for the specific accessory can be made from that menu by pressing **F1-F5**. The **Sh-Ctrl-Fkeys** option, when selected, allows direct access to desk accessories by pressing **Sh-Ctrl-F1** through **Sh-Ctrl-F5**. Selecting *Disabled* will inhibit entry to desk accessories. Once a desk accessory is displayed, any other desk accessory can be accessed by pressing only the function key associated with it (without pressing **Sh-Ctrl**).

When using PC-Term emulation, Local Leadin (in the F5 menu) must be on to access desk accessories. Then, to view the diagnostic menu, for example, press **Ctrl-Scroll Lock, Ctrl←, F5**.





### ANSI Keyboard

#### Disconnect: [Disabled, Shift-F5]

Choose to allow the keystroke that will generate a modem disconnect on the ANSI keyboard or to disable the Disconnect function.



If “F1 to F5 keys” selection is set to Fkey in Setup, the Disconnect function will be remapped to Ctrl-Shift-F5.

#### F1 to F5 keys: [Local, Fkey]

This selection determines whether the first five keys (labeled F1-F5) serve as local keystrokes (for example, **F3** allows access to Setup) or will serve as function keys which are loaded with the default strings. (Only reprogrammed strings are visible in the text area for a given function or edit key; the default strings are not visible in Setup).



If Fkey is selected, then the keystroke to enter Setup becomes Ctrl-F3 on the ANSI keyboard.



### ANSI Keyboard

With the three remapping selections, keys which are available on a PC keyboard are now available on the ANSI style keyboard: [ESC] [~] [ , and .].

These three selections should either be kept in their defaults (as they appear on the keyboard), or all three should be changed to follow the mapping scheme described here.

#### ~ Key: [ ' and ~ or ESC]

Select the characters sent by the tic/tilde key.

#### <> Key: [ < and > or ' and ~]

Select the characters sent by the triangle bracket key in the normal and shifted positions.

#### ., and .. Keys: [ , and .. or , < and .>]

Select the characters sent by the comma and period keys in the normal and shifted modes.

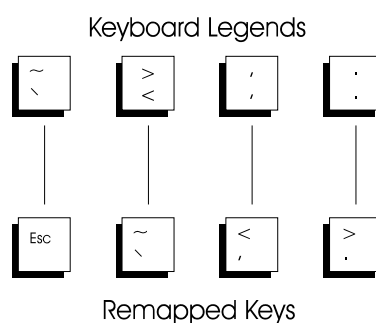

#### DEL Key: [BS/DEL, DEL/BS, DEL/CAN]

Choose the codes sent by the < x ] key on the ANSI keyboard in the normal and shifted positions.

#### Enter Key: [CR, CR-LF, TAB]

Select the code transmitted by the Enter key on the numeric keypad.

**Return Key:** [CR, CR-LF, TAB] select the code transmitted by the Return key on the main alphanumeric keypad.

#### Return Key Repeat: [On, Off]

Select whether the Return key located on the alphanumeric keypad will auto-repeat (only selectable when “Key Repeat” = On).

#### Compose Key: [Meta, Compose, Funct, Scroll-Lock, Alt Key]

This selection indicates the role that the Compose key will play. The explanation of choices is the same as the Alt Key selection on page 31.

## Ports: F6

**EIA Baud Rate:** [115200, 76800, 57600, 38400, 19200, **9600**, 4800, 2400, 2000, 1800, 1200, 600, 300, 150, 110]

See *Quick menu* on page 27.

**EIA Data Format:** [7/1/N, 7/1/O, 7/1/E, 7/1/M, 7/1/S, 7/2/N, 7/2/O, 7/2/E, 7/2/M, 7/2/S, **8/1/N**, 8/1/O, 8/1/E, 8/1/M, 8/2/N, 8/2/O, 8/2/E]

See *Quick menu* on page 27.

**EIA (Aux) Parity Check:** [On, **Off**]

Choose whether the parity bit will be checked. When parity check is on and the parity bit received is inconsistent with the data received, indicating an error in communications, an asterisk (\*) 2Ah is displayed instead of the character.

**Aux Baud Rate:** [38400, 19200, **9600**, 4800, 2400, 2000, 1800, 1200, 600, 300, 150, 134.5, 110]

See *Quick menu* on page 27.

**AUX Data Format:** [7/1/O, 7/1/E, 7/1/M, 7/1/S, 7/2/N, 7/2/O, 7/2/E, 7/2/M, 7/2/S, **8/1/N**, 8/1/O, 8/1/E, 8/1/M, 8/1/S, 8/2/N]

See *Quick menu* on page 27.

**EIA (Aux) Recv:** [No Protocol Xon-Xoff(XPC), **Xany-Xoff (XPC)**, DTR (DSR), Xany-Xoff/DTR (DSR)]

Choose the form of flow control for data received from the primary or secondary host. Software flow control uses *Xon-Xoff* DC1 (11h) and DC3 (13h). *XPC* is used by “Scan Code” mode because it uses DC1 and DC3 as data. *Xany-Xoff (XPC)* is similar to *Xon-Xoff*, except that any character transmitted to the host is treated as an Xon, so data from the terminal is buffered, rather than being sent to the host. *DTR (DSR for Aux)* relies on the hardware signal DTR or DSR (pin 20 or pin 6) from the device. *Xany-Xoff/DTR (DSR)* uses software and hardware flow control.



Flow control is recommended to protect against data loss.

**EIA (Aux) Xmit:** [**No Protocol**, Xon-Xoff, DSR (DTR), Both]

This is similar to “EIA (Aux) Recv,” except that it applies to the data transmitted from the terminal to the primary or secondary host or printer. DSR is the hardware signal for Data Set Ready (pin 6).

**EIA (Aux) Break:** [**250 ms**, 170 ms, 500 ms, Off]

Choose the duration of the break signal in milliseconds. This is an interruption in data flow, and can be disabled.

**EIA (Aux) Modem Control:** [On, **Off**]

If a modem is being used to communicate with the primary or secondary host, modem control should be *on*. To perform a disconnect, the terminal drops the DTR signal. In full duplex, the terminal keeps RTS high and checks for a CD signal before sending data to the modem. In half duplex, it raises RTS and awaits a clear-to-send (CTS) signal from the modem before sending data.

**EIA (Aux) Xmt Pace:** [**Baud**, 35 cps, 60 cps, 150 cps]

Define the maximum number of characters per second that the terminal can transmit. When a characters limit (35 cps, 60 cps, or 135 cps) is set, the delays are averaged between characters for the selected baud rate. This is also known as “pacing.” The *Baud* option provides no pacing, allowing data to be transmitted at the specified baud rate.

**EIA (Aux) Disconnect:** [**2sec**, 60ms]

Select the maximum time period that the modem can be disconnected (or the modem line be down) before the terminal performs a Modem Disconnect. This occurs if “EIA (Aux) Modem Control” is *on*.

## Host: F7

**Comm Mode:** [**Full Duplex**, Half Duplex, Full Block, Half Block]

Select the communications mode.



Half-duplex is not available when KeyMode is *ScanCode*.

**Receive <CR>:** [<CR>, <CR><LF>]

Select the way in which carriage returns received will be interpreted.

**Receive <DEL>:** [Ignore, Destruct <BS>]

Choose to ignore the DEL control code (7Fh) when received or to treat it as a Destructive Backspace code.

**Send ACK:** [Off, On]

Decide whether the terminal should respond to inquiry (05h) or when certain terminal functions are performed (configuring the EIA (Aux) ports, splitting screen, etc.) with the ACK (06h) character.

**Null Suppress:** [On, Off]

In the default mode, the host ignores all received NULLs (00 hex). When *off* is selected, the terminal will accept all received NULLs, and act upon them according to the selected emulation.

**Send Line Term:** [<US>, <CR><LF>]

Select which line terminator is sent. <US> is 1Fh and <CR><LF> is 0Dh 0Ah.

**Local:** [Off, On]

Select whether keyed data is interpreted locally by the terminal and not sent to the host. Data sent by the host is lost, if Local is *on*. The ability to print data is not affected by this mode.

**Send Block Term:** [<ETX>, <CR>]

Select which character will indicate the end of a block. The choices above are for ASCII emulations. ANSI emulations have the following choices: [None, FF].



**Send End:** [Cursor, Region]

Select whether the end is indicated by the scroll region or by the cursor location.



**Send Region:** [Screen, Scroll]

Choose whether the terminal sends data from the entire screen or from the scrolling region.

**Alt Input Data:** [On, Off]

This selection is only available when Sessions=One. this selection is only available in single-host mode. When *on*, it allows the serial port (either AUX or EIA) which is **not** being used for connection to the host as an alternative device for data input (such as from a bar-code scanner). The data will be routed from that serial port to the host port (either EIA or AUX). When *off*, data entry in this manner will be inhibited

## Print: F8



**Print Mode:** [Normal, Auto, Controller]

Select the way in which printing is controlled.

- **Normal** indicates that printing is to occur when a print request (such as print screen) is received.
- **Auto** prints a line when the terminal receives a LF, a FF, or a VT code, or when autowrap occurs.
- **Controller** indicates that host data is sent to the printer (pass through mode). Printing is controlled by the host computer.

**Print Block Term:** [<ETX>, <CR>]

Select the character which indicates to the printer that the block of data to be printed has ended. The options above are for ASCII emulations. In ANSI emulations, the choices are [None, <FF>].



**Print Region:** [Screen, Scroll]

Indicate the region of the screen that is to be printed: the entire screen or a certain section of it called the scrolling region. A scrolling region is a limited portion of the screen which applications (such as word processors) may designate to be the user's.



**Print Line Term:** [<US>, <CR><LF>]

Indicate the character that <R>is to terminate a line of print.

**Secondary Recv:** [Off, On]

When "on," data received from the serial printer is routed to the port assigned for the host. This data is not displayed on the screen, and is transparent to the user. When "off," data received from the printer port is ignored.

## Emulation: F9

The parameters displayed in this menu depend upon the current emulation. This section is divided between parameters for ASCII and ANSI emulations.

**ASCII Emulations**

**Page Edit:** [Off, On]

When page edit is *on*, edit features such as insert act upon text to the end of the current page.

**WPRT Intensity:** [Dim, Normal, Suppress]

Choose the intensity of write protected characters . Suppress indicates that the character's foreground is the same as its background with the effect of "suppressing" output.

**WPRT Underline:** [Off, On]

Choose whether write-protected characters are underlined.

**WPRT Blink:** [Off, On]

Choose whether write-protected characters blink.

**WPRT Reverse:** [Off, On]

Choose whether write-protected characters display in reverse video.

**Fkey Speed:** [Fast, Normal]

Selects the speed at which function keys and labels are programmed by the host. Fast mode will increase the speed for Wyse 50 compatibility, but will limit the amount of space in each function key and answerback message to 8 bytes. Edit keys are not available for programming in fast mode. Changing this selection will default all function keys, edit keys, and function keys labels.

**Save Labels:** [Off, On]

When *on*, labels that are downloaded by the host will be saved in non-volatile memory. If this selection and Display NV Labels are *off*, labels written by the host would be lost upon entry and exit to Setup.



**Attribute:** [Char, Line, Page]

Choose the extent to which attributes are propagated. (The only parallel ASCII emulations are PC Term and Wyse 60.)

**Display NV Labels:** [On, Off]

Select whether the labels in non-volatile memory are displayed on the lowest line. When *off* is selected, any existing labels will remain on the screen, until *on* is selected, and they are re-displayed. On a 26-line screen, they are displayed below line 24. On a 44-line screen, labels are displayed below line 42, and on a 52-line screen, they are displayed below line 50. (The top line is the top status line and cannot be used for data.) If the page length used is a multiple of 25 (instead of 24) and the screen length is 26 lines, then the last data line is used for data and labels will not be displayed regardless of this setting. The same is true for a page length that is a multiple of 43 (instead of 42) with a screen length of 44 lines.

**Status Line:** [Standard, Extended, Off]

Select the type of the status line. In *standard*, cursor row and column, emulation indicator, print indicator, Caps Lock, and communications mode are displayed. In *extended*, only emulation indicator, Caps Lock, communications mode, protect and write protect are displayed.

**Char Set:** [National, Multinational]

Select whether the character set used is the 7-bit national chart or the 8-bit multinational chart when Language is not U.S. If U.S. is chosen, the character set is *multinational*.

**Enhanced Attributes:** [Off, On]

When set to *on*, gives a better display presentation in overscan and reverse video modes. The blink and dim video attributes will affect the foreground text instead of the background. This selection is only available in reverse video mode, on a per-session basis, and is disabled in a "split" display screen.

**Bright Video:** [Off, On]

Provides a brighter display when set to *on*. Both normal and dim text is brighter than in the standard mode. This parameter setting affects both sessions, but will not affect an ANSI emulation in the inactive session.

## ANSI Emulations

**Numeric Kpd:** [Numeric, Application]

Choose the set of strings sent by the numeric keypad.

**Cursor Kpd:** [Cursor, Application]

Choose the set of strings sent by the cursor control keypad.

**Send Data:** [All, Erasable]

Choose whether the data sent to the host is all data (erasable and selectively erasable) or only those characters tagged as erasable.

**Print:** [National, Line Drawing, Multinational]

Choose the set of characters used when printing.

**ANSI-ID:** [VT100, VT101, VT102, VT220, VT320]

Select the terminal's identification.

**Function Key Lock:** [Off, On]

Select whether the function keys are locked or modifiable by the host.

**UPSS - [ANSI Supplemental, ISO-Latin]**

Select the character set from which to generate eight-bit characters. This selection is available only when "Char Set Mode" is *ANSI* (in the Kybd (F4) menu).

**Char Set:** [Multinational, National]

Select whether the character set used is from the 7-bit national chart or the 8-bit multinational chart. The default is the 8-bit multinational character set except when the emulation is VT100.

**Feature Lock:** [Off, On]

When on, the host cannot change user features: key repeat, scroll speed, screen background, tab stops, and keyboard lock.

**Status Line:** [Off, Indicator, Host-Write, Both]

Specify the way in which the status line is to be used: for host messages [host-write], as a cursor position indicator [indicator], for [both] or off.

## Tabs: F10

F1	F2	F3	F4	F5	F6	F7	F8	F9	<b>F10</b>	F11	F12	PrtSc																																																																	
Quick	Genrl	Disp	Kybd	Keys	Ports	Host	Print	Emul	<b>Tab</b> s	AnsBk	Prog	Exec																																																																	
<b>Parameters</b>																																																																													
<input type="checkbox"/> <b>Auto Init Tabs = Off</b>		Default Tabs																																																																											
<table style="width: 100%; border-collapse: collapse;"> <tr> <td style="text-align: center;">10</td><td style="text-align: center;">20</td><td style="text-align: center;">30</td><td style="text-align: center;">40</td><td style="text-align: center;">50</td><td style="text-align: center;">60</td><td></td><td></td><td></td><td></td><td></td><td></td><td></td> </tr> <tr> <td colspan="13" style="text-align: center;">.....</td> </tr> <tr> <td style="text-align: center;">T</td><td style="text-align: center;">T</td><td style="text-align: center;">T</td><td style="text-align: center;">T</td><td style="text-align: center;">T</td><td style="text-align: center;">T</td><td style="text-align: center;">T</td><td style="text-align: center;">T</td><td></td><td></td><td></td><td></td><td></td> </tr> <tr> <td colspan="13" style="text-align: center;">.....</td> </tr> <tr> <td style="text-align: center;">70</td><td style="text-align: center;">80</td><td style="text-align: center;">90</td><td style="text-align: center;">100</td><td style="text-align: center;">110</td><td style="text-align: center;">120</td><td style="text-align: center;">130</td><td></td><td></td><td></td><td></td><td></td><td></td> </tr> </table>													10	20	30	40	50	60								.....													T	T	T	T	T	T	T	T						.....													70	80	90	100	110	120	130						
10	20	30	40	50	60																																																																								
.....																																																																													
T	T	T	T	T	T	T	T																																																																						
.....																																																																													
70	80	90	100	110	120	130																																																																							
<b>Choices</b>																																																																													
<input type="checkbox"/> <b>Off</b>		On																																																																											
<b>Select</b>																																																																													
↑→↓← : Parameter				Enter/S-Enter: Next/Prev Choice					Exit: Pause																																																																				

### Auto Init Tabs: [On, Off]

When on, tab settings will always be defaulted at power up.

**Default Tabs:** This action field sets tabs at every eighth column starting at column 9.

When the cursor is placed in the Tab Map, the keys below will appear in the Choices field:

- **<Space>** – clear the current tab setting.
- **<Shift> <Backspace>** – clear all tab settings.
- **<T or t>** – set a tab at the current location.
- **<↑ → ↓ ← >** – move cursor on the Tab map or back to a Parameter field above the map.

## Answerback: F11

F1	F2	F3	F4	F5	F6	F7	F8	F9	F10	<b>F11</b>	F12	PrtSc
Quick	Genrl	Disp	Kybd	Keys	Ports	Host	Print	Emul	Tabs	<b>AnsBk</b>	Prog	Exec
<b>Parameters</b>												
<input type="checkbox"/> <b>Answerback Mode = Off</b>		Answerback Conceal										
Answerback Message: _____												
Bytes Remaining: 0542												
<b>Choices</b>												
<input type="checkbox"/> <b>Off</b>		On										
<b>Select</b>												
↑→↓← : Parameter				Enter/S-Enter: Next/Prev Choic					Exit: Pause			

### Answerback Mode: [On, Off]

Choose whether the answerback message (which is sent to the host at terminal reset or power up) mode is on. This can be used to log-in to the system.

**Answerback Conceal:** This is an action parameter which displays “Concealed” at the answerback edit field. Once it is concealed, the message cannot be redisplayed. This is a security measure for those who use answerback to send their login names and passwords to the host.

**Answerback Message:** This is a 30-character field which can be edited. (See the Edit Fields section later in this chapter.)



When “Fkey Speed” is *Fast* in the Emul (F9) menu, the answerback edit field is limited to 8 bytes.

## Program: F12

F1	F2	F3	F4	F5	F6	F7	F8	F9	F10	F11	<b>F12</b>	PrtSc			
Quick	Genrl	Disp	Kybd	Keys	Ports	Host	Print	Emul	Tabs	AnsBk	<b>Prog</b>	Exec			
<b>Parameters</b>															
Key = F1			Program = F/Key				Key Dir = Comm Dependent								
Text: _____ _____ _____															
Label: _____ Bytes Remaining: 0542															
<b>Choices</b>															
<b>F1</b>	F2	F3	F4	F5	F6	F7	F8	F9	F10	F11	F12	F13	F14	F15	F16
<b>Select</b>															
↑→↓← : Parameter				Enter/S-Enter: Next/Prev Choice					Exit: Pause						

**Program:** [F/Key, Sh-F/Key, Edit Key, Sh-Edit Key]

Specify the type of key to be programmed—function or edit key in its normal or shifted state.



When Fkey Speed is *Fast* in the EMUL (F9) menu, the Program options are F/Key and Sh-F/Key.



When SCO Console emulation is selected, the Program options are F/Key, Sh-F/Key, Ctl-F/Key, Ctl-Sh-F/Key, and Edit Key.

**Key Dir:** [Comm Depend, Host, Printer, Printer & Host, Screen, Host & Screen, Printer & Screen, All]

Select the destination of the contents of the function or edit key. *Comm Dependent* will cause the direction of the key data to correspond to the “Comm Mode” of the current emulation. For example, if the “Comm Mode” is *Full Block*, the contents of the key will be channeled to the screen only. If it were *Full Duplex*, then the contents would be sent to the host only.

**Text:** An edit field which permits up to 255 characters. Once the overall text limit (up to 542 characters) is reached, the terminal will beep and accept no more text. If the text is deleted with the backspace key, the default code is no longer programmed. Shift-Backspace will restore the default. See the *Edit Fields* section (page 38) or “Fkey Speed” in the Emulation section (page 34).

**Label:** A label of up to 7 characters can be entered for function keys in ASCII emulations only. See “Display NV Labels” on page 35.

- <Backspace> – delete
- <Shift> <Back> – default field

**Key:** Select the key to be programmed. The keys that are listed as choices depend upon the Program parameter as shown below:



When a PC style keyboard is attached, the choices are:

- When Program = *F/Key* or *Sh-F/Key*, the choices are [F1, F2, F3, F4, F5, F6, F7, F8, F9, F10, F11, F12, F13, F14, F15, F16].
- When Program = *Edit Key* or *Sh-Edit Key*, the choices are [Tab, Esc, Backspace, Delete, Return, Home, ↑, ↓, ←, →, EnterKpd, Insert, PageDown, PageUp, End, Print].



When an ANSI keyboard is attached, the choices are:

- When Program = *F/Key* or *Sh-F/Key*, the choices are [F1, F2, F3, F4, F5, F6, F7, F8, F9, F10, F11, F12, F13, F14, Help, Do, F17, F18, F19, F20].
- When Program = *Edit Key* or *Sh-Edit key*, the choices are [Tab, <X>, Select, Return, ↑, ↓, ←, →, Enter, Next Screen, Remove, PF1, PF2, PF3, PF4].



When the SCO emulation is selected (only applicable to the PC keyboard) the following choices apply:

- When Program = *F/Key*, *Sh-F/Key*, *Ctrl-F/Key*, or *Ctrl-Sh-F/Key*, the choices are [F1, F2, F3, F4, F5, F6, F7, F8, F9, F10, F11, F12].
- When Program = *Edit Key* or *Sh-Edit key*, the choices are [Home, Insert, PageDown, PageUp, End, ↑, ↓, ←, →].



- To program an ESC (escape) character into the key text, press Ctrl-[.
- To program a DEL character into the text field, press Ctrl-Shift-\* (alphanumeric keypad).

- To program a carriage return or line feed into the key text field, press Ctrl-M or Ctrl-J, respectively.
- To program the “Print Screen” key to perform a local print screen (page) function: In the key text field, press Ctrl-[ and then P. Next, set the “Key Dir”=Screen option.

## Execute: Prt Sc

F1 Quick	F2 Genrl	F3 Disp	F4 Kybd	F5 Keys	F6 Ports	F7 Host	F8 Print	F9 Emul	F10 Tabs	F11 AnsBk	F12 Prog	PrtSc Exec
<b>Parameters</b>												
<b>Save Terminal</b>				Recall Terminal				Default Terminal				
Save Session				Recall Session				Default Session				
Reset Terminal				Reset Session				Reset Ports				
Clear Screen				Default Session UDKS								
<b>Choices</b>												
Use Enter Key to Execute Action												
<b>Select</b>												
↑→↓← : Parameter				Enter/S-Enter: Next/Prev Choice				Exit: Pause				

All of the parameters in this menu are action parameters. **Terminal** parameters affect all settings, including the emulation. **Session** choices affect only settings that relate to the chosen emulation. In dual session (host) mode, there are two independent sets of session parameters (Session 1 and Session 2). To toggle between sessions, use the Ctrl-Enter (Num) keystroke.

**Save Terminal:** Save all settings in non-volatile (permanent) memory, including those associated with the session selected.

**Reset Terminal:** All terminal parameters are initialized. It also performs reset pages and default modes.

**Recall Terminal:** Revert to all terminal and session settings that were saved in nonvolatile memory. A “Reset Terminal” is also performed. This is referred to as a hard reset and is equivalent to turning the terminal off and back on.

**Default Terminal:** Load all defaults for the terminal and session, including the emulation. A “Reset Terminal” is also performed.

**Save Session:** Save all the settings associated with the chosen session.

**Reset Session:** Initialize all session settings. This is also referred to as a “Soft-Reset.” Perform page-resets and default modes. “Mode” specifies the parameters used by a session which are not selectable through Setup such as Insert-Mode, Split-Screen, and Graphics-Mode.

**Recall Session:** Load the previously saved settings associated with the chosen emulation. A “Reset Session” is also performed.

**Default Session:** Load all defaults associated with the **session** selected.

**Reset Ports:** Clear the transmit buffers for the host and printer port, and receive buffer for the host port. Unlocks the keyboard and clears its buffer data.

**Clear Screen:** Clear the screen and the entire page.

**Default Session UDKs:** Set the contents of all the function and edit keys associated with the chosen session to their factory default states.

## Edit Fields

Setup uses overwrite mode in text editing fields. That is, the cursor keys cannot be used to move to a location in the text to insert characters. Upon entry to a text field, the cursor is placed at the last text location. Use the following keystrokes:

- **Backspace** – move cursor left by deleting that character.
- **Shift-Backspace** – reset the field to its default value.
- **Alphanumeric keys** – enter text in the normal, shifted, or control state. To generate a control character (00h-1Fh) add 40h and use Ctrl with the character in the new position (40h-5Fh). For example, to insert CR-LF (0Dh, 0Ah) codes, press Ctrl-M, Ctrl-J (4Dh, 4Ah). The compose and meta functions can also be used to generate 8-bit characters.

## Glossary of Terms

Some of the terms that are used in the Exec (PrtSc) menu are defined below.

### Page Reset

Page resets are executed when the session or terminal is reset or defaulted. When a page reset is performed, it affects all pages, and the following events occur: the page is erased, the cursor is homed, and scrolling regions are defaulted. All line attributes (such as double-high/wide, locked lines) are reset to normal. Split screens are cleared to a normal, single screen and protect mode is turned off.

### Terminal Parameters

Terminal parameters includes session parameters (defined later) and non-session parameters that affect the terminal globally without regard to the session. The non-session parameters and their defaults are listed below:

- **Setup Parameters:** Bell Volume (6), Screen Saver (5 min), Overscan Borders (on), Language (U.S.), Keyclick (on), EIA(Aux) Baud Rate (9600), EIA (Aux) Data Format (8/1/N), EIA (Aux) Parity Check (off), EIA(Aux) Rcv Prtcl (Xon-Xoff/XPC), EIA (Aux) Xmit Prtcl (none), EIA (Aux) Break (250 ms), EIA (Aux) Xmit Pace (baud), EIA (Aux) Disconnect (2 sec), EIA (Aux) Modem Control (off), Session Display (full), Emulation Display (full), Refresh Rate (70 Hz), Bright Video (off), Enhanced Attributes (on), Setup Language (U.S.), Sessions (1), Caps Lock (Toggle), Num Lock (Toggle), Key Repeat (On), Speed (fast).
- **Desk Accessory Parameters:** Clock Display (off), Clock Type (12 hour), Clock Location (column 48), Date, Time (not saved) , Alarm Time (12 PM), Tone (alarm/hourly), Calculator (printer off, tape on), and the row and column in which each accessory is displayed.

### Session Parameters

Session Parameters are parameters that are specific to the emulation selected in the current session. These include three types of parameters: Setup-Edit keys, Setup, and Modes.

- **Setup-Edit Keys:** Function and Edit keys and the Answerback message.
- **Setup Parameters:** All other Setup variables that are not included in Setup Parameters in Terminal Parameters (all global settings).
- **Mode Parameters:** Variables that are used by a emulation's emulation, but are not selectable through Setup. Some examples are Protect Mode, Graphics Mode, Insert Mode, Aux Mode, Split-Screen, Transparent Mode, Character Set mappings, Setup Language, and Sessions.



## chapter

## 4

# Desk Accessories

This terminal features five desk accessories, which can be accessed one at a time through pop-up windows.

## Desk Accessory Menu

To display this pop-up window to choose any of the five desk accessories, press **Ctrl ←**.

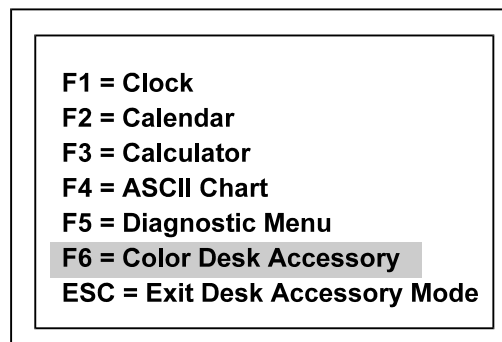

*Desk Accessory Menu*

Function keys **F1-F5** are used to display the clock, calendar, calculator, ASCII chart, and diagnostic menu, respectively.

**NOTE**

To access this menu, the selection “Desk Acc = Ctrl ←” must be chosen in the KEYS (**F5**) Setup menu.

## Direct Entry

To display any desk accessory directly, without the desk accessory menu, the following keystrokes are used:

- **Clock** - press **Shift-Ctrl-F1**
- **Calendar** - press **Shift-Ctrl-F2**
- **Calculator** - press **Shift-Ctrl-F3**
- **ASCII Chart** - press **Shift-Ctrl-F4**
- **Diagnostic Menu** - press **Shift-Ctrl-F5**
- **Color Desk Accessory** - press **Shift-Ctrl-F6**

You may also use a function key (**F1-F5**) to enter another desk accessory window, once one is entered.

**NOTE**

To use these keystrokes, the selection “Desk Acc = Sh-Ctrl-Fkeys” should be chosen in the KEYS (**F5**) Setup menu.

To reposition any window on your screen, hold down the **Shift** key while pressing a cursor control (**arrow**) key.

## Exiting A Desk Accessory

To exit any window and restore the original screen:



Press **F11** on the ANSI keyboard.



Press **Esc** on a PC keyboard.

## Inhibiting Access



Access to desk accessories can be inhibited by selecting “Disabled” for “Desk Acc” in the Keys (**F5**) Setup menu.

## Calendar

This displays a calendar for any month from the years 1900 to 2099. The current date is displayed at the bottom. The keys below control the calendar that is displayed.

- **Right-** and **left-arrow** keys - display an earlier or later month.
- **Up-** and **down-arrow** keys - display the selected month in an earlier or later year.
- **Esc** - exit calendar.

The specified calendar month will display as shown below.

JANUARY		1993				
SUN	MON	TUES	WED	THUR	FRI	SAT
					1	2
3	4	5	6	7	8	9
10	11	12	13	14	15	16
17	18	19	20	21	22	23
24	25	26	27	28	29	30
31						
Current Date : Jan. 01, 1993						

*Calendar*

## Clock

The clock menu (shown below) contains seven lines which can be modified.

Use the following keys to make changes:

- **Up-** or **down-arrow** keys - select a line. The line is highlighted.
- **Left-** or **right-arrow** keys - select a field on the chosen line. The selected field is now highlighted.
- **Spacebar**- move “up” through options available for this field.
- **Shift-Spacebar** - move “down” the options.
- **Enter** (kpd) - revert to the default setting for the current field.
- **Esc** - exit clock and save settings.

Date	Jan 1, 1993
time	08:00:00 AM
Display	Off
Type	12
Column	48
Alarm set	12:00 PM
Tone	Off

*Clock*



The clock is reset to 08:00 am at power up. Due to the limitations of the hardware, the clock may drift by 15 seconds per day. We recommend setting the terminal's time as part of the system log-in process.

**Date** - use the **left** or **right arrow** keys to highlight each field of the date (month, day, and year). Then use the **Spacebar** or **Shift-Spacebar** to cycle through the settings. The date can also be set by the host.

**Time** - use the procedure described for Date above to set the hour, minutes, or seconds.

**Display** - indicate whether only Time, only Date, or both the Time and the Date are displayed on the top status line. Display of Time/Date can also be turned Off. The date display can also be set by the host.

**Type** - select whether the clock functions on a 12-hour or 24-hour basis.

**Column** - set the column (36-99) in which the date/time will display (as enabled by Display above).

**Alarm Set** - time at which an alarm (a 1-2 second bell tone) should sound.

**Tone** - how alarm tone(s) should be activated: every Hour, on the Alarm setting only, or both on the Alarm setting and Hourly. The alarm tone can also be turned off.

## Calculator

The numeric keypad located on the right side of your keyboard will serve as your calculator. See the figures below to relate the display to the keys on the numeric keypad that control it.

The calculator can process up to 10 digits to the left of the decimal point, and up to 9 to the right. When a number or number operator is pressed, it is momentarily highlighted on the display.

Number operators are defined as follows:

- **+**, **-**, **/**, **X** - the respective operations of addition, subtraction, division, and multiplication.
- **MS** - stores the displayed value in memory. **MR** - displays the stored value.
- **M+** - adds the displayed value to memory.
- **+/-** - makes a number positive/negative.
- **C/A** - displays 0.0 when the **Num Lock** key is pressed.

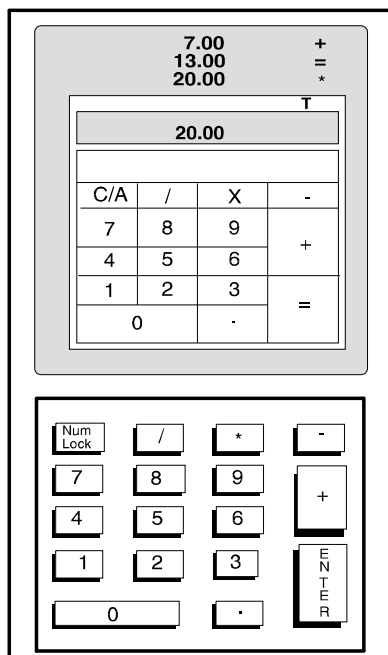

*PC Calculator Display*

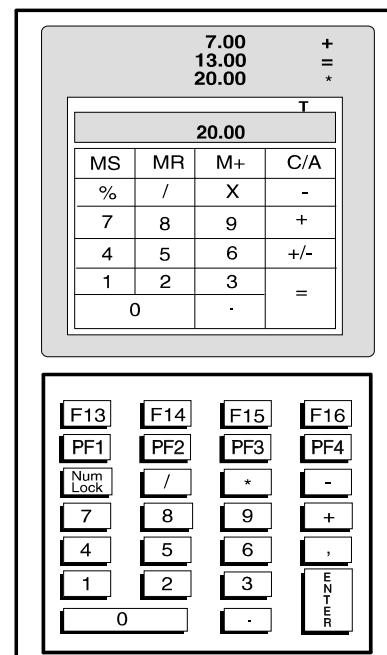

*ANSI Calculator Display*



Since the function keys **F13-F16** are not available on the PC numeric keypad, the following functions are not available: **MS**, **MR**, **M+**, **+/-**, and **%**. The **Num Lock** key will perform the **C/A** function. When using the Compact PC 101/102-key keyboard, the calculator layout displayed will be that of the PC 101-key keyboard. However, the “-” key is in a different location on the Compact keyboard.

### Additional Control Keys

In addition to the keys on the numeric keypad, you may use:

- **T** - toggle “tape” on/off. Results scroll above the display.
- **P** - toggle “printer” on/off. Results are transmitted onto the printer.



Use the printer option only when a printer is connected. Press **Ctrl-Shift-Tab** to clear a printer error.

- **X** - exit the calculator, transmitting the final result to the current application.
- **Ctrl-(a number on the numeric keypad)** - specify the precision, where the number of decimal places that will be displayed is equal to the number pressed with the **Ctrl** key.
- **Esc** - exit calculator.

## ASCII Chart

Upon entering the ASCII Chart Desk Accessory, the decimal, octal, hexadecimal, binary, and ASCII representations of the character under the cursor are displayed in the pop-up window (as shown for the NULL character in the image at the top of the right column).

FONT BANK 0				
DEC	OCT	HEX	BINARY	CHAR
126	176	7e	01111110	~
127	177	7F	01111111	?
000	000	00	00000000	
001	001	01	00000001	Ⓧ
002	002	02	00000010	Ⓜ

*ASCII Chart*

Use the following keys to change the display of the ASCII chart:

- **Up-** or **down-arrow** – scroll up or down the characters in the ASCII chart (0-127).
- **Left-** or **right-arrow** – scroll through the available font banks. The characters will display from the selected font bank.
- **Ctrl-↑**, **Ctrl-→**, **Ctrl-↓**, **Ctrl-←** – move the cursor on the screen up, right, down, or left. The ASCII chart will be redisplayed, and the chart will be centered on the character that the cursor now rests upon.
- **Esc** – exit the ASCII chart.

## Diagnostic Menu

This desk accessory is used to display terminal configuration information such as the amount of memory (RAM) in the terminal, the style of keyboard that you are using, and the firmware revision level. An example of the diagnostic menu is shown below.

*Diagnostics Disk Accessory Display*

Screen RAM		
Character	32K	P0000
Attribute	32K	P0000
CGEN RAM	8K	P0000
Scratch RAM	32K	P0000
NVRAM		P0000
Code Rom x.xx	128K	P0000
Keyboard Type	EPC	P0000
		000000
Video Timing		P0000
EIA port		P0000
AUX port		P0000
PARALLEL port		P0000
598-000xxx		000000

If you do require technical support, this menu provides a means for our support team to quickly assess your terminal installed options.

To display this diagnostic menu, use one of the keystrokes below:

- Press **Ctrl-←**, **F5**.
- Press **Ctrl-Shift-F5**.
- Press **Ctrl-Scroll Lock**, **Ctrl-←**, **F5**.

For details on entering and exiting desk accessories, refer to the beginning of this chapter.

## Color Utility

The Color Utility (260lfc only) is used to temporarily remap Colors and attributes on screen.



Changes made to any of the pre-defined palettes with this utility cannot be saved. To define your own color combinations, use the provided soft palettes.

To alter the color mapping for an attribute, use the up and down arrow keys to highlight one of the sixteen available attributes. Then, use the **left** and **right arrow** keys to select the background and foreground colors you want to assign to the highlighted attribute. Finally, press the **Esc** key to exit Desk Accessory Mode and view the Results on screen.



Only eight attribute combinations are defined for Wyse 325 and Wyse 60 emulations.

An example of the Color Utility is shown below.

ATTRIBUTE	FORE/BACK
NORMAL	TEXT
REV	TEXT
INT	TEXT
REV, INT	TEXT
UND	TEXT
UND, REV	TEXT
UND, INT	TEXT
UND, REV, INT	TEXT
BLINK	TEXT
REV, BLINK	TEXT
INT, BLINK	TEXT
INT, REV, BLINK	TEXT
UND, BLINK	TEXT
REV, UND, BLINK	TEXT
INT, UND, BLINK	TEXT
INT, UND, REV, BLINK	TEXT
Right Arrow →	Foreground Color
Left Arrow ←	Background Color

*Color Utility Desk Accessory Display*

# Compose

## ANSI-Multinational Compose Sequences

Composed Character	Description	3-Key Sequence	2-Key Sequence
“	Quotation mark	ï SP	ï SP
#	Number/pound	+ +	
'	Apostrophe	' SP	' SP
@	At	A A	
[	Left bracket	((	
\	Backslash	//	
]	Right bracket	)>	
^	Circumflex	^ SP	^ SP
`	Grave accent	\ SP	\ SP
{	Left brace	(-	
	Pipe	/ ^	^ /
}	Right brace	)-	
~	Tilde	~ SP	~ SP
ı	Inverted !	!!	
¢	Cent	C /	
£	Pound	C	
¥	Yen	L -	
§	Section	L =	
¤	Currency	Y -	
©	Copyright	Y =	
ª	Feminine ordinal	S !	
«	Left angle brackets	S O	
°	Degree	X O	
±	Plus or minus	C O	
²	Superscript 2	A _	
³	Superscript 3	<<	
µ	Micro	O ^	
¶	Paragraph	SP *	
·	Middle Dot	SP 0	
¹	Superscript 1	+ -	
º	Masculine ordinal	2 ^	
»	Right angle brackets	3 ^	
¼	One-fourth	/ U	
½	One-half	P !	

Composed Character	Description	3-Key Sequence	2-Key Sequence
¿	Inverted ?	??	
À	A grave	A \	A \
Á	A acute	A ´	A ´
Â	A circumflex	A ^	A ^
Ã	A tilde	A ~	~ A
Ä	A umlaut	A “	ï A
Å	A ring	A *	
		A °	
Æ	AE ligature	A E	
Ç	C cedilla	C ,	
È	E grave	E \	\ E
É	E acute	E ´	´ E
Ê	E circumflex	E ^	^ E
Ë	E umlaut	E “	
Ì	I grave	I \	\ I
Í	I acute	I ´	´ I
Î	I circumflex	I ^	^ I
Ï	I umlaut	I “	ï I
Ñ	N tilde	N ~	~ N
Ò	O grave	O \	\ O
Ó	O acute	O ´	´ O
Ô	O circumflex	O ^	^ O
Õ	O tilde	O ~	~ O
Ö	O umlaut	O “	ï O
Œ	OE ligature	O E	
Ø	O slash	O /	
Ù	U grave	U \	U \
Ú	U acute	U ´	´ U
Û	U circumflex	U ^	^ U
Ü	U umlaut	U “	ï U
ÿ	Y umlaut	Y ï	ï Y
b	German double s	ss	
à	a grave	a \	\ a
á	a acute	´ a	´ a
â	a circumflex	^ a	^ a
ã	a tilde	~ a	~ a
ä	a umlaut	a “	ï a
å	a ring	a *	
		a °	
æ	ae ligature	a e	
ç	c cedilla	c ,	
è	e grave	e \	
é	e acute	´ e	´ e
ê	e circumflex	e ^	^ e
ë	e umlaut	e “	ï e
ì	i grave	i \	\ i
í	i acute	´ i	´ i
î	i circumflex	i ^	^ i
ï	i umlaut	i “	ï i
ñ	n tilde	n ~	~ n
ò	o grave	o \	\ o
ó	o acute	´ o	´ o
ô	o circumflex	o ^	^ o
õ	o tilde	o ~	~ o
ö	o umlaut	o “	ï o
œ	oe ligature	o e	
ø	o slash	o /	
ù	u grave	u \	\ u
ú	u acute	´ u	´ u
û	u circumflex	u ^	^ u
ü	u umlaut	u “	ï u
ÿ	y umlaut	y “	ï y



## ANSI-ISO Latin-1 Compose Sequences

Composed Character	Description	3-Key Sequence	2-Key Sequence
	No break space	SP SP	
	Pipe	! ^	
¬	Logical not	- ,	
-	Soft (syllable) hyphen	- -	
®	Registered trademark	R O	
-	Macron	- ^	
		- ^	
¾	Three-fourths	3 4	
÷	Division sign	- :	
×	Multiplication sign	x x	
´	Acute accent	´ ´	
¸	Cedilla	´ ´	
¨	Diaeresis (umlaut)	“ ”	¨ SP
Ý	Y acute	Y ´	´ Y
ý	y acute	y ´	´ y
Ð	Capital Icelandic thorn	T H	
ð	Small Icelandic thorn	t h	
Ð	Capital Icelandic Eth	- D	
ð	Small Icelandic Eth	-	

appendix

## A

## Local Key

Action	Scan Code Mode	Keyboard
Toggle Caps-Lock	No	Caps Lock
Toggle Num-Lock	No	Num Lock
Toggle Scroll-Lock <sup>1</sup>	No	Scroll Lock
Toggle Auto Print <sup>2</sup>	Yes	Ctrl-Print Scrn
Toggle Block-Mode	Yes	Shift-Ctrl-Pause
Toggle Monitor Mode	Yes	Shift-Ctrl-1 (kpd)
Toggle Ins/Replace	No	Ctrl-Insert
Instant Screen Saver <sup>3</sup>	Yes	Ctrl-Shift-* (kpd)
Compose Lead-in <sup>4</sup>	No	Shift-<Alt (left)>
Func Lead-in <sup>4</sup>	No	Ctrl-<Alt (left)>
Meta Lead-in <sup>4</sup>	No	Alt (left)
Scroll-Lock <sup>4</sup>	Yes	Shift-Ctrl-<Alt (left)>
Soft Reset <sup>5</sup>	No	Shift-Scroll Lock
Hard Reset (Power On)	No	Shift-Ctrl-Scroll Lock
Break <sup>6</sup>	Yes	Ctrl-Pause
Modem-Disconnect <sup>7</sup>	No	Pause
Send-Answerback	No	Shift-Pause
Print-Page	Yes	Shift-Ctrl-Del\ .
Increment Scroll Rate <sup>8</sup>	Yes	Shift-Ctrl-↑
Decrement Scroll Rate <sup>8</sup>	Yes	Shift-Ctrl-↓
Raise Split <sup>9</sup>	Yes	Ctrl- - (kpd)
Lower Split <sup>9</sup>	Yes	Ctrl- , (kpd)
Split-Full Toggle <sup>9</sup>	Yes	Shift-Ctrl- - (kpd)
Roll-Window-Up <sup>9</sup>	Yes	Ctrl-↑
Roll-Window-Down <sup>9</sup>	Yes	Ctrl-↓
Change Status Line <sup>10</sup>	Yes	Ctrl- →
Home & Clear Page	Yes	Shift-Ctrl-Home
Auto Adjust Window	Yes	Ctrl-Home

*Continued*

Continued

Action	Scan Code Mode	Keyboard
Toggle Session	Yes	Ctrl-Enter (kpd)
Enter Desk Accessory Mode	Yes	Ctrl-←
Enter Setup Mode	Yes	Ctrl-Scroll Lock
Exit Setup Mode	Yes	Pause
Enter Clock <sup>11</sup>	Yes	Ctrl-←,F1
Enter Calendar <sup>11</sup>	Yes	Ctrl-←,F2
Enter Calculator <sup>11</sup>	Yes	Ctrl-←,F3
Enter ASCII Chart <sup>11</sup>	Yes	Ctrl-←,F4
Enter Diagnostic <sup>11</sup>	Yes	Ctrl-←,F5
Exit Any Desk Accessory	Yes	Esc
Next Page <sup>12</sup>	No	Ctrl-Page Down
Previous Page <sup>12</sup>	No	Ctrl-Page Up
Display Page 0 <sup>13</sup>	No	Ctrl-0\Ins
Display Page 1 <sup>13</sup>	No	Ctrl-1\End
Display Page 2 <sup>13</sup>	No	Ctrl-2\↓
Display Page 3 <sup>13</sup>	No	Ctrl-3\Page Down

**Notes:**

1. This function is operational only if EIA (Aux) Rcv-Prctl = Xon-Xoff/XPC or DTR
2. In ANSI emulations, this keystroke toggles in and out of Auto Print Mode.
3. This function is operational even if Screen - Saver is set to off.
4. The ACTION/Keystrokes shown for these Local Functions are programmed as defaults and can be changed through the "ALT key" parameter in setup mode.
5. This function unlocks the keyboard, turns off all print modes and re-initializes the serial ports for setup parameters.
6. The length of the Break - Signal is dependent on the setup parameter of "EIA (Aux) Break".
7. This keystroke is dependent on the "Disconnect" setting in the "Keys" (F5) setup menu.
8. The Increment Scroll Rate toggles the scroll rate to the fastest smooth scroll. This function also stops at the jump scroll. The Decrement Scroll Rate toggles from jump scroll to the fastest smooth scroll toward the slowest smooth scroll.
9. These functions are not available in ANSI emulations.
10. The Change Status Line function will toggle in the status line display from "Indicator" to "Host Write" to "Both" to "Off" in ANSI Emulations and "Standard" to "Extended" to "Off" on ASCII Emulations.
11. Keystrokes for these functions are only operational if the "Desk Acc= Ctrl-←" in the setup menu.
12. When a Split Screen is not enabled, these keys select the next or previous pages. Wrapping takes place from the last page to the first and vice versa.
13. These local functions are operational only if the selected page is available.



In Scan Code Mode (PC-Term emul.), this chart applies only when Local Leadin is on.

## Page Configurations - Single Host Mode

Lines per Page	Number of Pages in 80-Only Columns	Number of Pages in 80 or 132 Columns
24	4	2
48	2	1
96	1	-
*24	2 (24/72)	2 (24/32)
25	3	2
50	1	1
*25	2 (25/71)	2 (25/31)
42	2	1
84	1	-
*42	2 (42/54)	-
43	2	1-
86	1	-
*43	2 (43/53)	-



When a page length (in the first column) is preceded by an asterisk (\*), a total of two pages will be available. The first page contains the selected number of lines and the second page contains the remaining allowable lines in memory. The number of lines are listed on this chart as (first page/second page).

## Page Configurations - Dual Host Mode

Lines per Page	Number of Pages in 80-Only Columns	Number of Pages in 80 or 132 Columns
24	1	1
25	1	1
42	1	-
43	1	-



All other configurations of lines per page (such as 48, 96, etc.) are not valid in dual session mode.

## Note To Installer

This equipment complies with the FCC Regulation for Class A devices, Subpart J of Part 15. Shielded, grounded interface cables were used on all ports for FCC radiated emission testing.

The manufacturer is not responsible for any violation of the FCC Regulation for Class A devices that is caused by unauthorized modification of the equipment, or caused by equipment installation not in accordance with the instructions in this manual.

This equipment generates, uses, and can radiate radio frequency energy and may cause radio or television interference. All user equipment that interfaces with other products should be connected with shielded cables. (Contact a local dealer for more information on shielded cable assemblies and their availability.)

There is no guarantee that interference will not occur. If radio or television interference occurs (this can be determined by turning the equipment off and on while the radio or television is on), the user is solely responsible for correcting the interference and is encouraged to take one or more of these measures:

1. Reorient the receiving antenna.
2. Relocate the equipment, or move the equipment away from the receiver.
3. Plug the equipment into a different outlet so the unit and receiver are on different branch circuits.
4. Consult the dealer or an experienced radio/television technician.

It is also suggested that the user read the FCC booklet entitled "How to Identify and Resolve Radio-TV Interference Problems". The booklet is available from the US Government Printing Office, Washington, DC 20402. (When ordering the booklet, specify stock number 04-000-00345-4.)

### Site Preparation

The screen display geometry on terminal products is aligned using magnetic devices. External magnetic fields created by other types of electronic equipment, such as printers, in very close proximity to the terminal, may cause minor display distortion.

Examples of display distortion include:

- Shaky video
- Wavy lines
- Tilted display

This magnetic field interaction only occurs over a very short distance, normally less than twelve inches, and can be corrected by separating the equipment and/or slightly reorienting the display.

## Technical Support

Questions about this product should be directed to the Technical Support Department of the distributor from which you obtained your Boundless Technologies equipment. When requesting assistance, please have all pertinent information available including any error messages that may have appeared either on the terminal or the host.

If your distributor fails to provide adequate support for your needs, please contact the Boundless Technologies Technical Support Department directly. You will be required to provide the name of your distributor, and a description of the problem as described above.

Please refer to the Boundless Technologies Guide to Support Services which was packaged with the terminal.

Boundless Technologies can be reached at:

Boundless Technologies, Inc.  
Technical Support Department  
100 Marcus Blvd.  
Hauppauge, NY 11788

(800) 231-5445 ext. 7259 (voice) ⇔ (631) 342-7259  
(631) 342-7378 (fax) ⇔ (631) 342-7395

Email: [support@boundless.com](mailto:support@boundless.com)  
ftp: <ftp.boundless.com>  
Web site: <http://www.boundless.com>