

Lattice's Cyrus Y. Tsui on:  
Programmable logic

# COMPUTER DESIGN

*Technology  
and Design  
Directions*

\$5 USA  
\$6 Canadian  
®

**FOR ELECTRONIC ENGINEERS & ENGINEERING MANAGERS**

## PC-based CAE/CAD: any task, anywhere, anytime

**Graphics ICs target  
Windows acceleration**

**Peripheral interfaces offer  
fast networking solutions**



*Don't miss **SBus News** in this issue*



## MAYBE YOU JUST NEED BETTER DRIVERS.

Stuck in a SCSI data-transfer bottleneck?

A first-class SCSI-2 VME board *could* get you out of that jam... *if* getting that board up and running doesn't leave your whole engineering team in gridlock.

That's why, when you buy a Rimfire SCSI-2 VME board from Ciprico, you don't just get a product. You get a partner.

As your partner, we'll help you write the drivers you need, and provide on-site installation. We'll even work with your engineering team to customize hardware or software for your special application needs.

*And* you get Rimfire's unmatched performance, quality and features. Like the new Rimfire 3870 and 3590 – the first VME boards with independent two-channel SCSI-2 architecture.

First-class hardware *and* first-class support and service. *That's* how you beat bottlenecks. And *that's* what Ciprico is all about.

### TURN TO CIPRICO WHEN YOU'RE IN A SCSI JAM.

**CALL 1-800-SCSI-NOW**

Ciprico, Inc.  
2955 Xenium Lane  
Minneapolis, MN 55441  
Fax: (612) 559-8799

**CALL (44) 635 873666**

Ciprico (Europe) Ltd.  
7 Clerewater Place, Lower Way  
Newbury, Berkshire RG13 4RF England  
Fax: (44) 635 871996

CIRCLE NO. 1

CIPRICO



Innovative Technology  
In System Packaging

## the Backplane

# One Thing Separates a Great Backplane from a Good One.

It's the innovative application of cutting-edge technology to your specific requirements. It's what we do at Electronic Solutions.

There was a time when a backplane was little more than a few connectors mounted to a simple pc board. But today's higher performance systems require higher performance multilayer backplanes. Someone has to resolve the difficult issues faced in designing a backplane that will handle your high-speed system—a balancing act between design parameters that affect crosstalk, reflections, impedance, ground shift, and power distribution.

That's where Electronic Solutions can make your job easier! You can rely on our

experience and expertise to resolve the design issues you're facing quickly—at a price that even your bean counters will be pleased with.

**For industry standard backplanes** such as VME, Multibus I or II, Sun, VXI, or Futurebus+ we have a line of high performance backplanes available off the shelf. Our backplanes have been independently tested and ranked as the "Best Balanced" backplanes available.

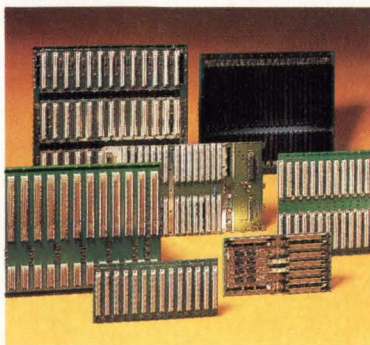

VMEbus  
VXI bus  
Sun bus  
Multibus I  
Multibus II  
Futurebus+  
Mixed buses  
Proprietary buses

**For proprietary backplanes**, no matter how exotic or unusual, we'll apply the same design expertise exemplified by our standard products and build you a backplane tailored to your specific requirements.

Let us prove it to you! Just call and request information on our backplane design capabilities and we'll FAX the FACTS right to you. Or ask to talk to one of our Applications Engineers who will help you translate your requirements into a backplane spec.

For standard or proprietary applications, there's only one way to get a backplane that's just right for your system. That's to call Electronic Solutions and put our experience to work for you.



One example of our design innovation is our patented **Active Automatic Daisy Chaining** which eliminates the number one field service problem—improperly placed Bus Grant Jumpers. It's superior to the passive auto-daisy chaining touted by other vendors, and it's available *free of charge* on our new VME backplanes.



**Electronic Solutions**  
UNIT OF ZERO CORPORATION

6790 Flanders Drive, San Diego, CA 92121  
(619) 452-9333 FAX: 619-452-9464  
**Call Toll Free: (800) 854-7086**  
In Calif: (800) 772-7086

# Why Settle for 1/2 an '040 Board?

You've chosen the '040 because you need maximum performance in your VME system. But look carefully, because other Single Board Computers may only give you only half of what you expected from the '040.

Compare Synergy's SV430 performance to any other SBC. Compare bus speed, MIPS, support, flexibility, documentation, reliability, I/O intelligence or any spec you can think of. We think you'll find the same thing we did—the

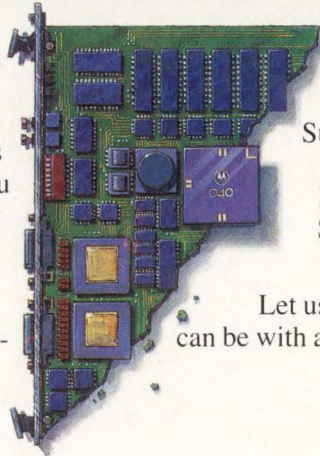

SV430 outperforms every other SBC on the market by as much as 150%.

Surprisingly, this kind of quality won't cost you any extra, because Synergy products lead in another important area—value. At Synergy, you don't have to pay a premium price for premium performance.

Let us show you just how far ahead your system can be with a Synergy processor board. Call us today, and get the *whole* '040 story.

## Compare our specs. Synergy is superior across the board!

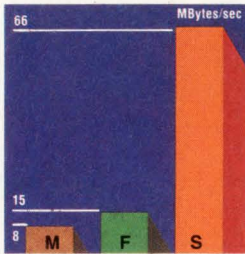

### VME Transfers

VME64 doubles bus performance to 66 MB/s—and the SV430 is the only '040 board that has it. But we don't need VME64 to win this comparison.

Even normal 32-bit transfers race at 33 MB/s. That's 200% faster than Force or Motorola.

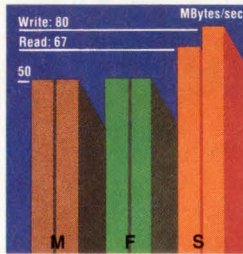

### DRAM Burst Rates

A 25 MHz '040 is capable of accessing memory at 80 MB/s. The closer you are to this maximum, the more '040 performance

you're gaining. SV430 bursts are 26% faster than Force and Motorola.

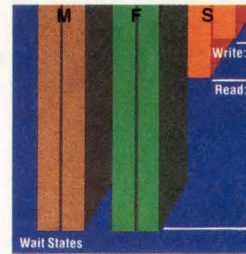

### DRAM Random Accesses

Non-burst '040 performance is measured in wait states. Fewer wait states mean higher performance. The SV430 is not only 66%

faster than Force or Motorola, it supports twice the on-board memory—32 MB.

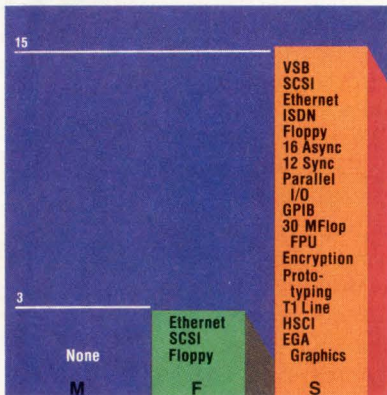

### I/O Modules

Synergy's EZ-Bus modules are compatible with our entire line of SBCs. This means Synergy's current line of 12 intelligent I/O modules are immediately available for the SV430—today. No other vendor comes close for selection, functionality or availability.

Data from Motorola MVME165 data sheet dated 2/90, and Force CPU-40 data sheet A1 Rev. 1. DRAM measurements shown are with parity. VMEbus transfers are to a 60ms slave.

VME64 is a trademark of Performance Technologies, Inc.

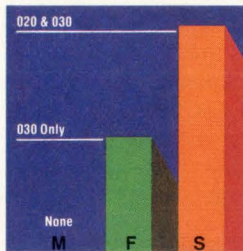

### '020/'030 Compatibility

Software compatibility between Synergy SBCs means users have simple upgrades to the SV430 from our '020 and

'030 SBCs. Force offers compatibility only from the '030 level, and Motorola offers "upward migration"—a polite phrase that means rewriting your code.

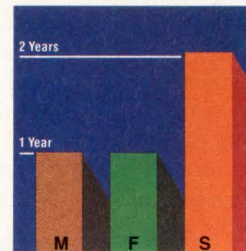

### Product Warranty

Synergy backs the reliability of its SBCs with a two year standard warranty. Force and Motorola only offer you one.

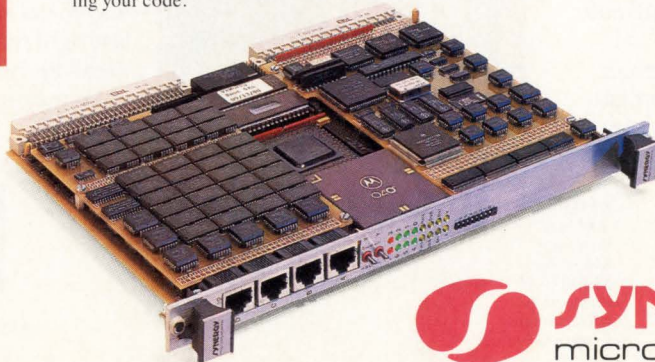

Synergy Microsystems, Inc., 179 Calle Magdalena, Encinitas, CA 92024 (619) 753-2191 FAX: 619-753-0903

INSTANT DATA ACCESS (IDA) DIAL (617) 494-8338 DOCUMENT NO. 1042



CIRCLE NO. 3

# COMPUTER DESIGN

*Technology  
and Design  
Directions*

FOR ELECTRONIC ENGINEERS & ENGINEERING MANAGERS

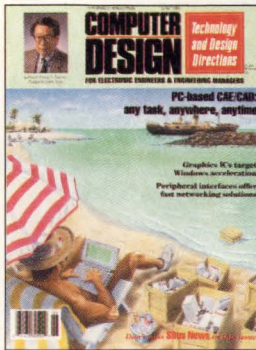

This month's cover story discusses the many PC-based CAE/CAD systems available to engineers. Can you pick out the phoney software in our vacationing designer's baggage? ..... 83

*Illustration by  
Mike Gardner*

Editorial..... 14  
 Calendar ..... 18  
 Letters.....149  
 Advertiser Index.....151

**COMING  
NEXT  
MONTH**

*High-performance  
network interfaces*

*Benchmarking  
digital and mixed-  
signal simulators*

*Software testing*

*Logic analyzers*

**NEWS BRIEFS**

Price cuts up the ante in programmable market . . . Hardware emulation pioneer Quickturn sues PiE . . . New Sparcs in a new Sun . . . Teradyne looks to shrink EDA product line . . . CFI puts its standards to the test . . . Turf tiff threatens IBM/Siemens DRAM deal . . . X Windows, NFS come to embedded systems . . . Second helpings . . . FDDI — killed at the starting gate? ..... 10

**TECHNOLOGY DIRECTIONS**

**Integrated Circuits**

ASIC core brings fuzzy logic to semiconductors ..... 28  
 Setting the record straight on SRAM loading..... 32

**ASICs & ASIC Design Tools**

Technologies move toward hardware/software codesign ..... 35

**Software & Development Tools**

Tools wed Ada compilers to integrated development environments..... 42

**Computers & Subsystems**

VMEbus SSBTL spec now on target..... 48

**CAE/CAD Tools**

Alliances help bridge the gap between IC design and test..... 54

**NEW PRODUCT DEVELOPMENTS**

**Integrated Circuits**

Next-generation Sparc — can less be more? ..... 118  
 Simpler is faster for new Windows chip..... 120

**CAE/CAD Tools**

Unix-based CAE suite adapts to multitool environments ..... 122  
 Software generates analog behavioral models..... 123

**Computers & Subsystems**

Mini motherboard helps PC/104 expansion ..... 124  
 Data acquisition marries DSP on single board ..... 126

**ASICs & ASIC Design Tools**

Oki enhances sea-of-gates performance..... 127  
 High functionality per cell in AT&T FPGAs ..... 128

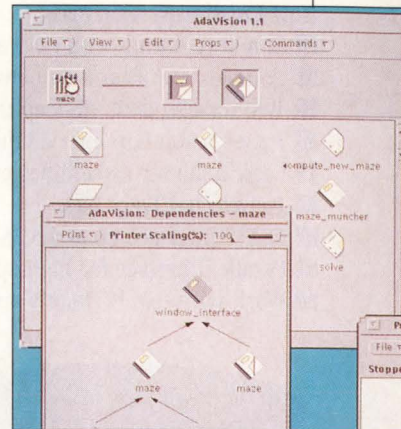

Page 42

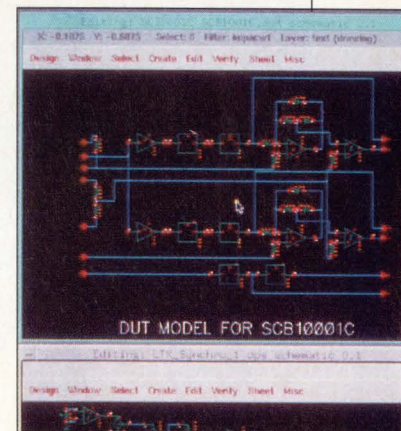

Page 54

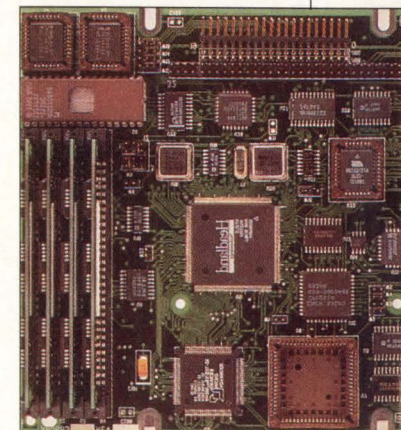

Page 124

# HMI development systems do it all!

HMI provides complete development systems—in-circuit emulator, window driven source level debugger and software performance analyzer—that address all aspects of the microprocessor system design cycle, from prototype to production:

## HMI Emulators Feature:

- Run at real-time with no wait states.
- Complex events and sequences for break and trigger conditions.
- Two independent 4K deep trace buffers.
- 1  $\mu$ sec resolution interval timer.
- Logic analyzer capabilities built into the emulator.
- 16 External Trace bits.
- RS232 Interface up to 115.2K.
- Parallel Interface for high-speed downloading.
- Work with IBM PC family and UNIX based machines including SUN and Apollo.

## EMULATORS

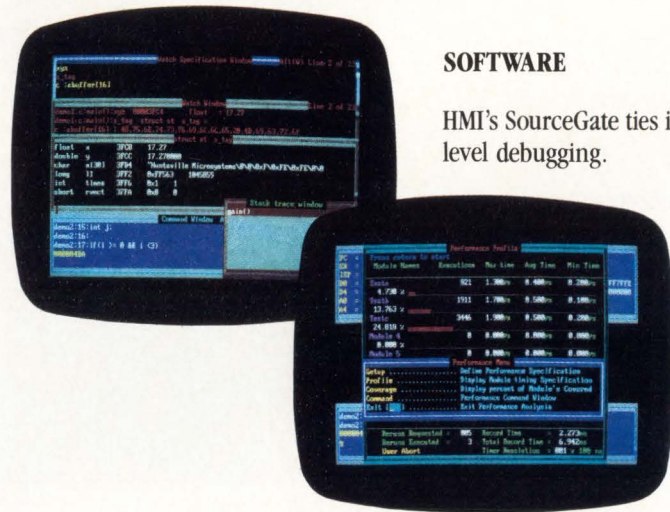

## SOFTWARE

HMI's SourceGate ties it all together, so emulator features aren't sacrificed to gain source-level debugging.

## HMI SourceGate® Features:

- Custom window configuration determined by user.
- Support for major C, PL/M, Pascal and ADA compilers.
- Source code in the trace buffers.
- C variable tracking.

Add our Performance Analysis Card to complete your development package.

## Performance Analysis Features:

- Real-time hardware implemented software performance analyzer.
- 100 nsec resolution time-stamp in trace buffer.
- Setup trigger conditions to start and stop analysis.
- View covered and not covered pieces of code.

## ANALYZERS



If you are looking for one development system that does it all, call (205) 881-6005, or write to Huntsville Microsystems Inc., 3322 South Memorial Parkway, Huntsville, AL 35801. Ask for *free* demo disk.

### AVAILABLE EMULATORS

68000	68330/333	68HC001
68008	68331/332	8051 Family
68010	68340	DS5000
68020	6809/6809E	8096/80196 Family
68030	68EC020	8085
68302	68EC030	64180/Z180
68301/303	68HC11 including F1 and D3	Z80 68HC16 Family

Now supporting 68040 Series



IBM is reg. T.M. International Business Machines, Inc. UNIX is reg. T.M., Bell Laboratories, Inc.

CONTINUED FROM PAGE 3



**Lattice Semi's  
Cyrus Y. Tsui on:  
Programmable logic**

Given the rapid pace and great diversity of the computer industry, it's sometimes difficult to stand back, take stock of the past and apply lessons learned to the many possible directions of the future.

23

**Special Section**

**SBus News**  
Technology and Market Update for SBus Users and OEMs

**Sun hangs onto share of VME market**

**SBUS competition heats up**

See Page 131

**TECHNOLOGY & DESIGN REPORTS**

**Peripheral interfaces offer fast networking solutions**

HiPPI and Fiber Channel may have been defined as peripheral interfaces, but designers are taking advantage of their high data transfer rates to solve their networking problems. —Warren Andrews ..... 59

**Graphics ICs target Windows acceleration**

With GUIs such as Windows setting new standards, chip vendors are rethinking the most cost-effective way to speed up graphics. So instead of a few solutions, designers now have many. —Dave Wilson ..... 71

**COVER STORY**

**PC-based CAE/CAD: any task, anywhere, anytime**

The PC is today's most popular engineering platform. Portable, powerful, fast, and inexpensive, it's a match for workstations in all but the most demanding CAE/CAD applications. —Jon Gabay..... 83

**DESIGN STRATEGIES**

**The fastest single-shot scope in the west**

The new HP 54700 series digitizing oscilloscope from Hewlett-Packard represents an absolute triumph of mixed-signal design. —Dave Wilson ..... 99

**PRODUCT FOCUS**

**What's real in real-time operating systems?**

One of the most critical "build or buy" decisions facing real-time system designers is whether to purchase an off-the-shelf real-time operating system (OS) or make your own. —Jeffrey Child ..... 107

**COLUMNS**

**MIXED-SIGNAL DESIGN** —Stephan Ohr

Analog behavioral simulation: not yet system-level. .... 139

**PCs IN DESIGN** —Jon Gabay

Inside looking out. .... 143



Page 59

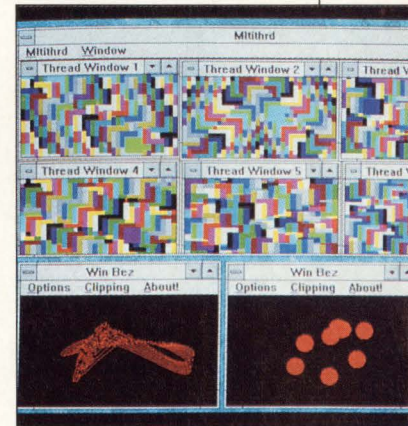

Page 71

Signal Strength: 0.10

Azimuth: 248.336

Command = 248.336

Mode: Preset Position

ChooseFunction	Help	F1
	Edit/Detail	F2
	Store	F3
	Stop	F4
	Optrack	F5
	Steptrack	F6
	Men Track	F7
	Intelsat	F8
	Preset	F9
	Position	F10

Number: 1 Axis:A2/EL

No.	Name	Con
1	Boresight	
2	Intelsat U (F-8)	
3	Westar VIS	

Preset Position Detail

Preset: 1 Config: 1

Execute Read Store as 1

Page 107



If you're looking for  
 realtime computing that's  
 really open, there's only one

place to really get it. Digital.  
 Our longtime leadership  
 in realtime computing,

combined with our total  
 commitment to standards,  
 makes it possible to offer you

**D I G I T A L . T H E O P**

© Digital Equipment Corporation 1992. The DIGITAL logo, DECnet, VAXELN, DECelx, rtVAX, TURBOchannel and VMS are trademarks and VAX is a registered trademark of Digital Equipment



the industry's most complete, product-rich, open realtime environment. And, best of all, it's available now.

Digital's adherence to standards provides you

with a truly open advantage. Not only does it give you flexibility in your choice of realtime systems that afford you unmatched portability and interoperability, but it also fully protects your computing investments.

Digital's support for a wide range of standards includes POSIX 1003.1, draft 1003.4, TCP/IP, DECnet™/OSI, Motif® and the VME, SCSI and TURBOchannel™ buses. Plus, we now offer realtime

extensions to OSF/1.®

In addition to complying with open standards, Digital makes available a host of development tools that will boost your productivity.

Besides expanding the scope of our VAXELN™ Realtime toolkit for the VMS™ environment, we're introducing the same capabilities for UNIX® environments with our DECelx™ toolkit. Once again, our open approach leaves the choice up to you.

Digital's open realtime story continues with our Network Application Support (NAS) standards-based open computing products. You can

share applications from different vendors across computing platforms. What that means is no matter what size computers you have in your realtime environment—from embedded processors to mainframes, no matter what operating system you're using, Digital can tie it all together. A better solution because it's an open solution.

Open standards. Open development tools. Open hardware and software. In short, an open environment. It's time you took advantage of Digital's open realtime computing. To find out how, just call 800-DEC-INFO (332-4636), ext. Realtime.

**digital**™

**E N A D V A N T A G E .**

Corporation. Motif and OSF/1 are registered trademarks of Open Software Foundation, Inc. Unix is a registered trademark of Unix System Laboratories, Inc. in the USA and other countries.

# Synchronous 4Mb At 100MHz,

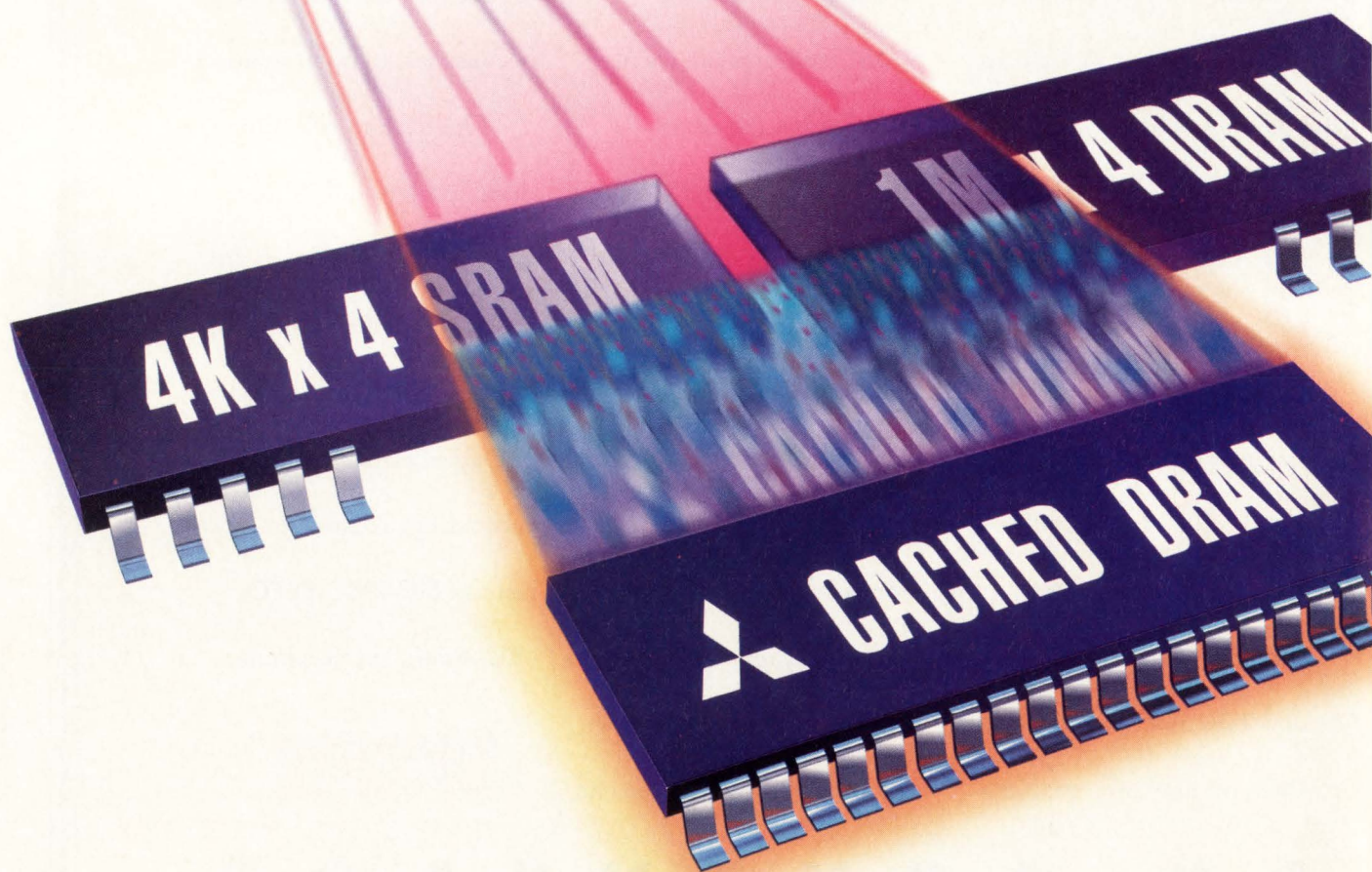

# Cached DRAM. It Screams!

Matching low-cost DRAM technology with today's high-speed CPUs can be a design engineer's nightmare. Until now. **Introducing the 100MHz 4Mb Cached DRAM from Mitsubishi.**

## FIRST SYNCHRONOUS DRAM

Mitsubishi combined a fast, 4K x 4 SRAM and a 1M x 4 DRAM with a wide, 16 x 4 bit internal bus and a synchronous clock design, all into one tiny TSOP IC. The result is the industry's first synchronous DRAM with on-board cache.

## 100MHz OPERATION

The Cached DRAM's large, 16 x 4 bit internal data path can transfer a 16-line data block in just one cycle, allowing the small on-chip cache to perform like a much larger external cache. The result is fast, 100MHz performance at a much lower cost than separate cache configurations. Plus, the Cached DRAM's fast copy-back scheme significantly reduces the miss cycle penalty time.

## COST-EFFICIENT, SMALL SIZE

The Cached DRAM die and package are only 7% larger than those of a standard 1M x 4 DRAM. And, since they are manufactured with the same process and on the same production line as Mitsubishi's standard 4Mb DRAMs, Cached DRAMs are highly cost-efficient to manufacture.

## LOW POWER OPERATION

With a clock that can be stopped to reduce power consumption to as low as 1mW, the Cached DRAM is ideal for portable and highly integrated applications where low power consumption, compact size and fast operation are essential.

## MITSUBISHI'S CACHED DRAM PERFORMANCE

Part Number	Cache Hit Access/Cycle	Cache Miss Access/Cycle	Direct Array Access/Cycle	Package
M5M44409TP-10	10ns/10ns	70ns/280ns*	70ns/140ns	TSOP**
M5M44409TP-15	15ns/15ns	75ns/300ns*	75ns/150ns	TSOP**
M5M44409TP-20	20ns/20ns	80ns/320ns*	80ns/160ns	TSOP**

\*Cache hit cycles can resume after one miss access time, while the copy-back completes in the background.

\*\*TSOP Type II. Also available in reverse pin-out TSOP.

Samples Available June 1992

Not your ordinary next-generation DRAM, Mitsubishi's 4Mb synchronous

Standard 4Mb DRAM.

Actual size.

4Mb Cached DRAM is only 7% larger than a standard 4Mb DRAM.



Cached DRAM sets a totally new standard for cost-effective, high performance memory. For more information and technical specifications, please call (408) 730-5900, ext. 2106 or 2226.

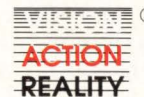

 **MITSUBISHI**  
ELECTRONIC DEVICE GROUP

## Price cuts up the ante in programmable market

Not long after Actel (Sunnyvale, CA) announced price reductions of up to 28 percent on its ACT 1 and ACT 2 FPGAs, industry leader Xilinx (San Jose, CA) lowered the price of its XC2000 family of FPGAs to under \$5, putting the programmable devices at about 3× the cost of equivalent gate arrays. "It has been our goal since the inception of Xilinx to drive down the price of FPGAs until there was a limited cost incentive to use a custom gate array," says Xilinx president Bernard Vonderschmitt. Users are willing to pay the 3× price premium, claims Xilinx, because of other cost savings associated with FPGAs.

While Xilinx positions its FPGA silicon to cut into the gate array market, Actel is placing its FPGA design tools in competition with traditional PLD/PAL tools by cutting prices as much as 33 percent on its Action Logic System Release 2.1 toolset for ACT 1 and ACT 2 FPGAs. Commenting on dramatic price reductions of PLD synthesis software from Minc (Colorado Springs, CO), worldwide sales manager Mark Smith says, "We've taken state-of-the-art software technology for PLD design and made it available to virtually everyone." For the next three months, Minc's entry-level PLDesigner System 200 will be \$495 (from \$1,950) and the PLDesigner System 300 will be \$795 (from \$2,950). —Barbara Tuck

## Hardware emulation pioneer Quickturn sues PiE

Days after being issued a patent on its reprogrammable hardware emulation technology, Quickturn Systems (Mountain View, CA) filed legal action against PiE Design Systems (Sunnyvale, CA), charging patent infringement by PiE with its recently introduced MARS product line. The patent, filed on December 2, 1988, protects the fundamental technology essential to the construction of any reprogrammable hardware emulator, according to Quickturn, which claims to have spent \$25 million developing and bringing to market

its Xilinx-based RPM Emulation System.

PiE's marketing strategy has been to present its Xilinx 4005-based emulator as a "second-generation architecture" to the 3090-based Quickturn system. Quickturn president and CEO Phillip A. Kaufman says, "Quickturn believes in open competition and providing the market with choice, which is what we did when we brought a new technology to a market dominated by software simulators and simulation accelerators. However, legitimate competition should come from the development of new technologies, and not from exploiting the inventions and intellectual properties of others." PiE's product marketing director Lavi Malhotra replies that Quickturn's claim that PiE's product is virtually identical to Quickturn's product is blatantly false. "PiE uses a radically different and more advanced architecture in its logic emulation system," insists Malhotra, "and does not in any way infringe Quickturn's patent." —Barbara Tuck

## New Sparcs in a new Sun

Sun Microsystems (Mountain View, CA) has introduced the Sparcstation 10, its newest high-end workstation. Built around a 40-MHz version of the new super-scalar SuperSparc chip (formerly called the Viking) from Texas Instruments (Dallas, TX), the workstation runs at speeds of up to 200 SPECint92, 228 SPECftp92 and 300 Mips. This is the first workstation to provide built-in Integrated Services Digital Network (ISDN) capabilities, the standard for worldwide digital telephone and networking services.

The real innovation, however, is the modular design, allowing up to four CPUs in one system, making it the first RISC workstation from a major vendor to include multi-processing capabilities. Using M bus modules, the system can support one, two or four microprocessors. The module also permits upgrades to external cache—1, 2 or 4 Mbytes of cache can be provided via modules. While Sun chose the 3.1-million-transistor TI chip over the new, smaller Pin-

nacle super-scalar chip from Cypress Semiconductor (LOCATION), the implication of the modular architecture is that either can be used—in fact, any super-scalar, Sparc-compatible chip on an M bus module could be utilized. If this approach works, Sun won't be tied to any single semiconductor vendor.

Maintaining its commitment to open systems, Sun has also announced that it will sell the logic chips needed to build Sparcstation 10. These five ASICs are available immediately from LSI Logic (Milpitas, CA). —Jeff Child

## Teradyne looks to shrink EDA product line

Teradyne (Boston, MA) is set to end several frustrating years of trying to make its mark in the EDA arena by selling off tools it acquired through its 1987 merger with Case Technology and Aida. Teradyne's EDA division (Santa Clara, CA) is looking for a buyer for the Vanguard PCB design tools developed by Case, as well as the automatic test pattern generation tools, logic simulation software and timing analysis tools developed by Aida.

Teradyne also intends to terminate further development plans on its MultiSim Architect, a tool that was to include logic synthesis capabilities developed by Dassault Electronique (Saint Cloud, France).

Teradyne will remain active in EDA with the MultiSim Interactive Designer and the Lasar simulator, products which now account for about 80 percent of its EDA sales. —Mike Donlin

## CFI puts its standards to the test

With the announcement of major EDA projects from four leading computer companies, the CAD Framework Initiative (CFI—Austin, TX) hopes to produce some real-world implementations of its Release 1.0 framework standard. The four firms are Hewlett-Packard (Palo Alto, CA), IBM (Armonk, NY), Siemens-Nixdorf (Pederborn,

*Continued on page 12*

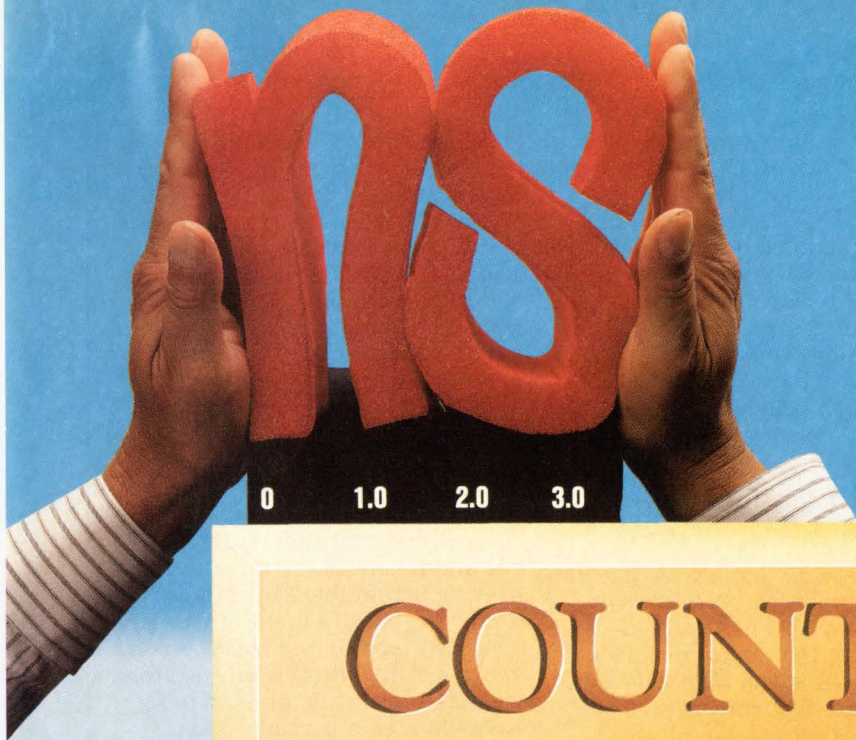

# COUNT ON IDT

## When Every Nanosecond Counts

Squeeze critical nanoseconds from your high-speed logic interface with the fastest FCT logic available. IDT's FCT-CT family offers speeds that are 50% faster than standard FCT or FAST logic families — as fast as 3.4ns (typical)!

## The Perfect System Solution

As a system designer, you need the perfect combination of:

1. **Fastest speed**
2. **Low ground bounce**
3. **Low power consumption**

FCT-CT logic has true TTL compatibility for ease of design. The reduced output swings and controlled output edge rate circuitry ensure low system noise generation. No other technology offers higher speeds or lower power consumption.

The FCT-CT family is completely pin- and function-compatible with FCT logic, and is available today in all standard packaging.

FUNCTION	PROPAGATION DELAY (Max)	OUTPUT ENABLE (Max)	OUTPUT DISABLE (Max)
Buffers	4.1ns	5.8ns	5.2ns
Transceivers	4.1ns	5.8ns	4.8ns
Registers	5.2ns	5.5ns	5.0ns
Latches	4.2ns	5.5ns	5.0ns

## Free Logic Design Kit

Call our toll-free hotline today and ask for **Kit Code 3061** to get a **1991 High-Speed CMOS Logic Design Guide** and **free FCT-CT logic samples**.

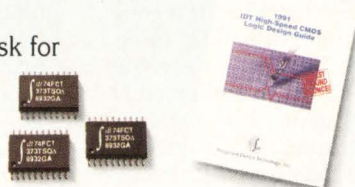

**(800) 345-7015 • FAX: 408-492-8674**

The IDT logo, CEMOS, BiCEMOS, and R3051 are trademarks of Integrated Device Technology, Inc.

CIRCLE NO. 6

## 12ns 256K SRAMS

Fastest cache solutions for RISC and CISC CPUs. 36+ ultra-high-speed sub-micron SRAMs for 33MHz processing & beyond are in the **SRAM Data Book**.



## 35mips RISC CHIPS AND MODULES

R3000A for the most mips at any MHz; R3051 for CPU, cache, & buffers on one chip. Modules, eval. boards & software complete the family. See them in the **RISC Data Book**.

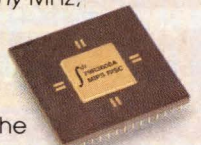

## HIGHEST-PERFORMANCE MEMORIES

Fast FIFOs, dense dual-ports, BiCEMOS ECL, & memory modules. 120+ FIFOs & multi-port memories, 5ns ECL, & multi-chip modules are in the



**Specialized Memories Data Book.**



Call today for your new IDT data books with complete technical specifications and application information.

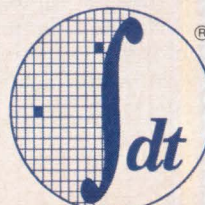

**Integrated Device Technology, Inc.**

*Continued from page 10*

Germany), and Sun Microsystems (Mountain View, CA).

According to Andy Graham, president of CFI, the joint efforts of the four computer companies and several leading EDA vendors reflect a commitment by CFI to become more customer driven. "The projects that these companies are involved in are implementations of the CFI standard that are intended to solve design problems within their respective organizations," says Graham. "These aren't idle exercises for academic purposes, but integration tasks that will result in products being developed and sold. We believe that their success will validate the promises that we've been making for the last few years."

—Mike Donlin

## Turf tiff threatens IBM/Siemens DRAM deal

Since 1990, IBM (Armonk, NY) and Siemens (Munich, Germany) have been working under a technology transfer arrangement to develop the next generation of 64-Mbit DRAMs before the Japanese can hit the market. Now the time has come to build the fab line and a three-way tug-of-war between the two electronics giants and the German government over where to locate the plant could throw a monkey wrench into the project. According to the news magazine, *Der Spiegel*, IBM and Siemens had been negotiating over whether to build the plant outside Munich (where Siemens is headquartered) or near IBM's German headquarters in Stuttgart. Enter the German government.

Bonn is desperately trying to breathe some economic life into the eastern part of Germany, and appears unwilling to grant any subsidies whatever unless the new plant is located near Dresden. Since the costs are estimated at around \$1.5 billion, both IBM and Siemens have been counting on government help. Siemens appears to be willing (however grudgingly) to go along with the idea, but IBM, which will only produce chips for internal use, is balking and might decide to produce them in East Fishkill, NY. Siemens, on

the other hand, is being wooed by Singapore with offers of subsidies and cheap skilled labor. The stakes are especially high for Siemens, which is planning on leveraging off the 64-Mbit memory technology for its later generations of processors. And any delay will only allow the Japanese to get in ahead of what was planned as a U.S./German first.

—Tom Williams

## X Windows, NFS come to embedded systems

The E-Venix/386 Unix real-time operating system from VenturCom (Cambridge, MA) has been enhanced with the ability to embed X Windows and the NFS (Network File System) file sharing protocol on a diskless single-board computer. The ability to embed X Windows will make it easier to design dedicated equipment with a graphical interface for use by nontechnical users. Until now, a window-based GUI for an embedded system had to be located on a separate system or terminal and communicated with the embedded code via a serial or network link.

The ability to embed the NFS protocol, in addition to the advantage of file sharing during runtime, will make it easier for programmers to do remote downloading, backup and debugging, according to VenturCom. E-Venix/386 is based on USL Unix System V.

—Tom Williams

## Second helpings

It's been rumored that Futurebus+ maker CCT (Anaheim, CA) will soon be looking at its first follow-up order from the U.S. Navy as a result of successfully completing the first part of the Next-Generation Computer Resources (NGCR) contract. Now that its equipment has passed full compliance testing and received approval of the Navy and the first systems have been delivered, CCT is looking to receive a second order for what the company now calls its 2010 Graphic Workstation. This comprises the basic boards and rack offering the functionality called for in the initial contract, plus a CCT-developed Futurebus+ array processor.

CCT's board set includes a CPU

board, central arbiter/analyzer module, error-correcting memory module, and SCSI and VME adapter module. According to the company, all cards are fully compatible with the 896.1 and 896.2 specifications, complying with the Profile A standard, including cache coherence. The company's CPU card, the FBP-030, is based on a 33-MHz 68030 processor with DRAM, as well as on-board PROM containing Microware's OS-9 real-time OS.

CCT appears to have beaten the other prime contractors, Litton and Raytheon, to the punch in delivering acceptable Futurebus+ hardware in fulfillment of a contract awarded by the Navy almost two years ago. Raytheon, working with its subcontractor, Nanotek, has delivered a partial system (without cache coherence) based on the earlier Futurebus+ form factor, but hasn't delivered a complete item.

—Warren Andrews

## FDDI—killed at the starting gate?

The lifetime of FDDI-II may be cut short by ATM (Asynchronous Transfer Mode), a wide-area network that hopes to find its way down to the desktop. Fore Systems (Pittsburgh, PA) is already developing and commercializing a LAN system based on the ATM standard. Robert Sanson, executive vice-president of Fore, says that his network system is an R&D development sponsored by the U.S. Naval Research Lab in Washington, DC. In operation, each workstation on the network must have an ATM adapter card; in the center of the network, an ATM switch supports up to 64 ATM connections, each running over multimode fiber at up to 155 Mbit/s. A 16-connection version of the switch is running at beta test sites, and the same ATM architecture will be used to develop a 64-connection version later this year. Presently, adapter cards are available for both Sun and Digital workstations. Adapter cards cost around \$5,000, the switch is around \$4,000 per connection.

—Dave Wilson

NOW AVAILABLE:  
ALSYS ADA COMPILERS  
FOR THE HP 9000 SERIES

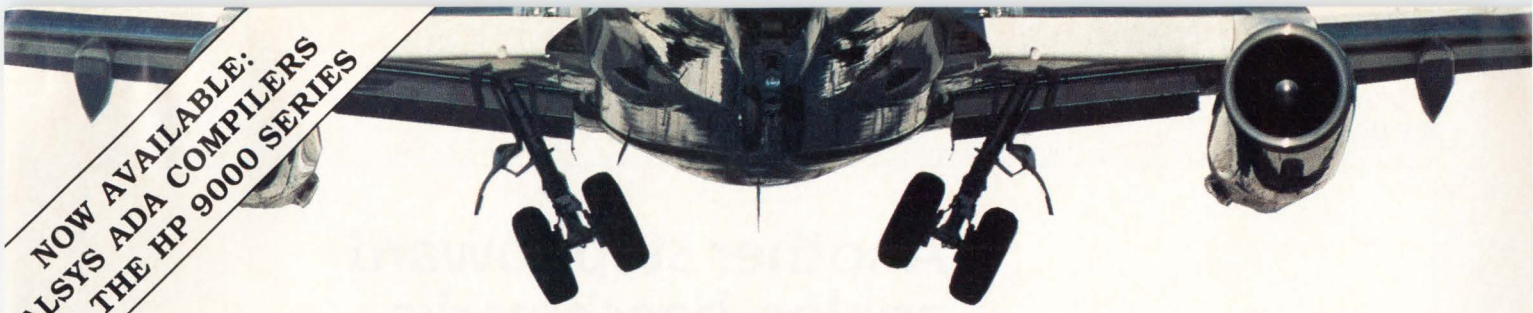

# If you don't think our real-time systems have taken off, consider some of the programs we've landed.

You already know the significance of the Alsys name when it comes to quality Ada. But you may not have realized that over half of our business is in—and over half of all our resources are devoted to—real-time applications. Right now Boeing, Lockheed, McDonnell Douglas, NASA, AIRBUS, European Space Agency and many others rely on us for solutions for mission and safety-critical applications. Alsys offers one of the broadest ranges of compiler products and developer tools, plus unparalleled expertise and guidance every step of the way.

If you need to reduce risk, deliver projects on time, and do both within budget, the first step is easy: send in the coupon, or call 617-270-0030. We'll rush you a handbook detailing some powerful reasons why you should consider enlisting our support. Alsys. We're serious about real-time.

Please rush me the Alsys handbook detailing your real-time capabilities.



(name) \_\_\_\_\_ (title) \_\_\_\_\_

(company) \_\_\_\_\_ (phone no.) \_\_\_\_\_

(address) \_\_\_\_\_

Alsys, Inc., 67 South Bedford Street, Burlington, MA 01803-5152,  
phone: 617-270-0030 fax: 617-270-6882

Alsys maintains major operations  
in the U.S., Sweden, France,  
England, Germany and Japan.

**alsys** CD  
A Thomson-CSF company

***We'd like to hear from you if you're involved in analog/mixed-signal design and have gone through the effort of developing your own benchmark circuits or procedures.***

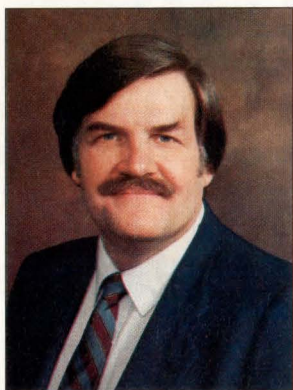

**John C. Miklosz**  
Associate Publisher/  
Editor-in-Chief

## Another step toward analog benchmarks

If you think that sorting the facts from the fiction in advertising claims, promotional material and the statements made by enthusiastic salesmen about PLDs is difficult (see "We need more PEP(s)," *Computer Design*, May, p 22), welcome to the world of analog and mixed-signal simulation. Benchmarking PLDs and digital simulators, by comparison, is child's play.

When it comes to analog, there's no agreement about the meaning of "behavioral" simulation, for example, and there's an ongoing debate about whether "it" is as reliable or as accurate as traditional Spice simulations, about who should develop device models, about what's an "adequate" device model, and what's the "best" way to simulate a mixed analog/digital circuit.

Some of these issues were addressed last year at the first Analog & Mixed-Signal Design Conference, held in Santa Clara, CA. Two presentations in particular, "Understanding Mixed-Mode Simulators," presented by Mark Chadwick of Analogy, and "Benchmarks, Benchmarking and Other Forms of Deception," presented by Hal Alles of Mentor Graphics, stand out, as do the panel discussions "Simulation and Device Modeling," moderated by Mike Donlin and Steve Ohr, and "Who Really Won BCTM," moderated by Steve Ohr. The panel discussions last year were especially lively because the audience could challenge any statements made by the panel members, most of whom were representatives of EDA tool vendors.

Well, the *second* annual Analog & Mixed-Signal Design Conference is coming—October 28-30 at the San Francisco Airport Hyatt Regency. We have the opportunity to tackle some of these tough issues again and, we hope, move a little closer to providing analog and mixed-signal designers with tangible help in making their simulator choices. Prompted by the interest shown by conference attendees last year and a proposal from Mentor's Hal Alles, Steve Ohr is organizing an extended panel discussion on "Guidelines for Benchmarking Mixed-Signal Simulators," to be held the first day of the conference. In connection with this panel discussion, Steve is asking EDA tool vendors and mixed-signal IC vendors to contribute specific circuits/devices that they believe could be used to exercise and evaluate an analog/mixed-signal simulator or a specific capability of a simulator. Steve isn't looking for circuits that will "crash" a simulator, or a circuit that will produce a "winner" or a "loser," or one that every tool vendor could claim to have simulated "best," with the definition of best being up to the individual tool vendors. In essence, Steve is looking to model these analog simulator benchmarks and benchmarking procedures along the lines used by PEP, the programmable device evaluation consortium discussed in this editorial last month. On Steve's behalf, I'd like to reach out to all of *Computer Design's* readers and ask for your help. If you're involved in analog/mixed-signal design and have gone through the effort of developing your own benchmark circuits or procedures, we'd like to hear from you. Call Steve (at 908-232-1380) or me (at 508-392-2114) and let's talk about how you can contribute to this effort. Thanks.



# RADISYS GIVES VME THE INSIDE ADVANTAGE

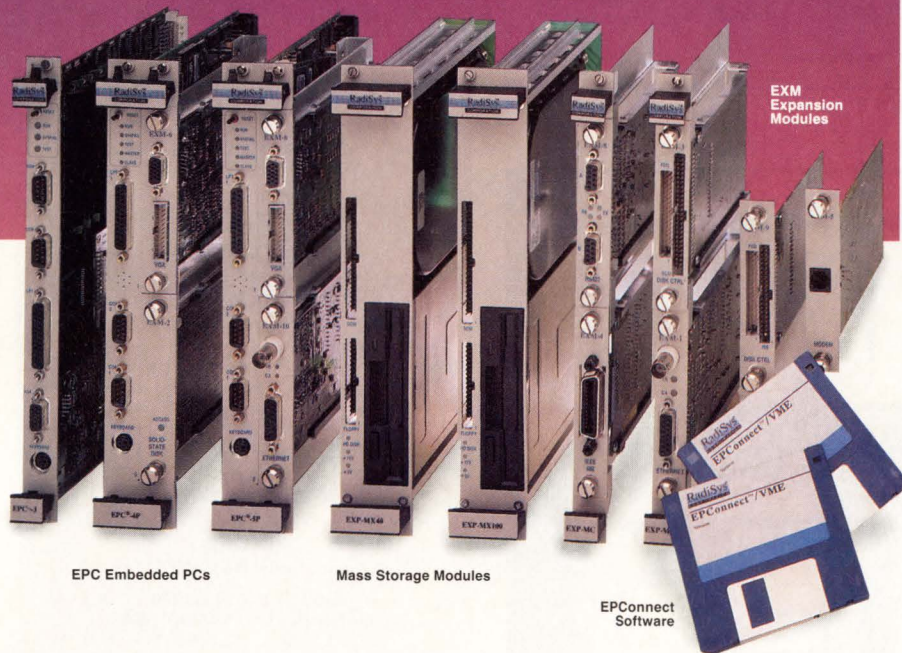
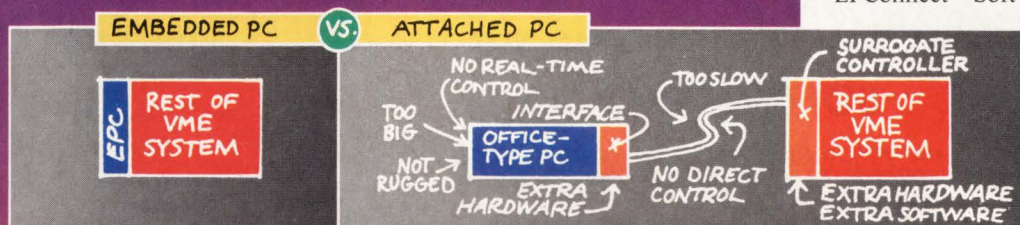

Integrating a PC with your VME system is a smart move. The "PC advantage" provides a superior human interface and access to the PC's huge base of system, application and development software.

The PC Advantage belongs inside your VME system. Not attached to it. By embedding a PC inside your VME card cage, instead of attaching it externally, you break through the inherent communications bottleneck that constricts system performance. You also eliminate the superfluous hardware and software needed to attach two system architectures.

Only RadiSys EPC® Embedded PCs completely integrate the strengths of PC and VME. An EPC, with its exclusive EPCConnect™ Software, is the only 386- or 486-based, PC-compatible computer with software that integrates the VMEbus into the DOS, Windows, UNIX and OS/2 environments. EPCs give your VME systems:

- Highest system performance from the real-time responsiveness of the direct 32-bit interface between the 386 or 486 and the VMEbus.
- Improved system packaging in 1/10th the volume, with integral VME ruggedness, and no bus link baggage.

And EPCs cost you less. EPC-based systems avoid the costly pitfalls of attached PC systems. No extra interfaces, cables, surrogate controllers, or the software to make them work.

Give your VME systems the EPC advantage. Call (800) 950-0044. We'll send all the details. No strings attached.



**RadiSys**  
CORPORATION

THE INSIDE ADVANTAGE

RadiSys Corporation  
19545 NW Von Neumann Dr.  
Beaverton, OR 97006 USA  
(800) 950-0044  
(503) 690-1229  
Fax (503) 690-1228

EPC MODEL	EPC-1 (shipping since Aug '88)	EPC-3 (shipping since Aug '89)	EPC-4 (shipping since Mar '90)	EPC-5 (shipping since Oct '90)
<b>Processor Modules:</b>				
CPU	80386	80386SX	80386	80486
CPU Clock	16 or 20MHz	16MHz	25 MHz	25 or 33 MHz
DRAM	1 or 4 MBytes	1, 2 or 4 MBytes	4, 8 or 16MBytes	4, 8 or 16 MBytes
Graphics	EGA (640 x 350)	VGA (800 x 600)	VGA (800 x 600)	VGA (800 x 600)
<b>Mass Storage Modules:</b>				
Hard Disk Capacity	40 MBytes		40, 100 or 200 MBytes	
Floppy Drive Size/Cap.	3.5" / 1.44 MBytes		3.5" / 1.44 MBytes	
<b>Expansion Capabilities:</b>				
PC Add-in Cards	Yes		Yes	
EXMbus Expansion	N/A	EXM Expansion Modules:		
		EXM-1 Ethernet	EXM-5 Modem	EXM-9 IDE/Floppy Ctrl.
		EXM-2 Solid State Disk	EXM-6 VGA Graphics	EXM-10 Ethernet
		EXM-3 SCSI/Floppy Ctrl.	EXM-7 RS232 Serial I/O	EXM-11 Timer/Counter
		EXM-4 IEEE 488	EXM-8 RS422 Serial I/O	EXM-12 Prototyping Card
<b>Software Support:</b>	EPCConnect development, run-time, and multiprocessing software package for DOS, Windows, UNIX and OS/2			

Copyright © 1989 RadiSys Corporation. All rights reserved. RadiSys and EPC are registered trademarks and EPCConnect is a trademark of RadiSys Corporation. 386 and 486 are trademarks of Intel Corporation. OS/2 is a trademark of International Business Machines Corporation. UNIX is a trademark of American Telephone and Telegraph.

The Intel Inside logo is a trademark of Intel Corporation.

# 200 MFLOPS OF POWER!

- Single or dual i860 processors
- Up to 64 MB memory
- True color frame buffer option
- AT or VME
- DT Connect, ITI VISIONbus, SCSI I/O options

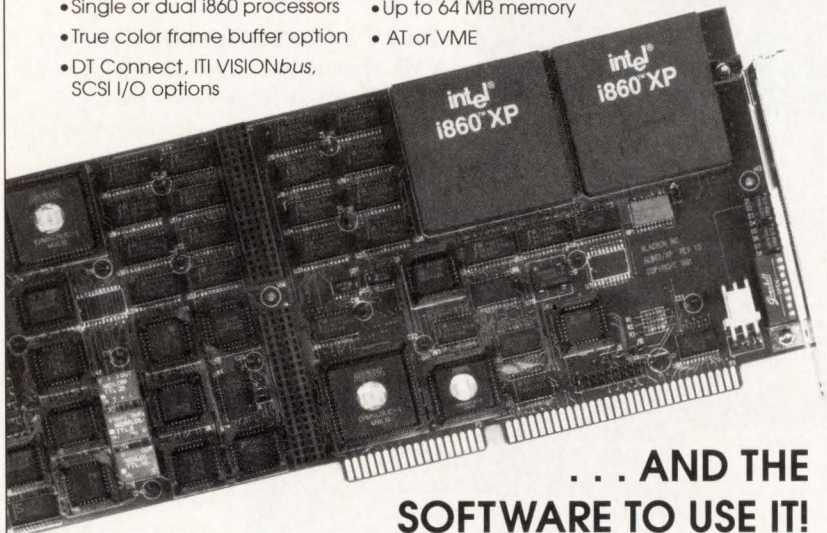

## ... AND THE SOFTWARE TO USE IT!



Suite 204, 71 Spitbrook Rd.  
Nashua, NH 03060  
Phone: (603) 891-2750  
Fax: (603) 891-2745

- For DOS, Unix 386, Sun OS, VxWorks
- i860 Native Unix Sys V.4 with X Windows 11.4
- Fortran and C compilers
- Scientific and imaging libraries with over 250 routines
- $256^2$  2DFFT  $\leq$  55MS
- $512^2$  3x3 convolution  $\leq$  88MS

Trademarks are property of their respective holders.

CIRCLE NO. 9

REAL-TIME

# SPARC

## Integrated VME Workstation

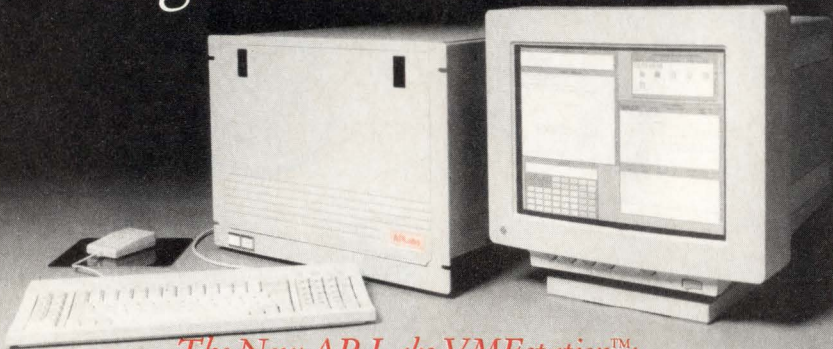

*The New AP Labs VMEstation™:*  
*Fully integrated systems for seamless real-time development...*

- SPARCengine or 68000 series architecture
- SunOS and VxWorks with AP Labs' Asynchronous I/O
- RDBXworks™: C source-level SPARC debugger
- Fully integrated VME and SBus I/O real-time device driver support
- Data Acquisition; Communications; Signal Processing

**AP Labs**

6215 Ferris Square  
San Diego, CA 92121  
(619) 546-8626  
Fax: (619) 546-0278

SPARC, SPARCengine, SunOS and SBus are trademarks of Sun Microsystems, Inc. VxWorks is a trademark of Wind River Systems. 68000 is a trademark of Motorola, Inc.

CIRCLE NO. 10

16 JUNE 1992 COMPUTER DESIGN

# COMPUTER DESIGN

*Technology and Design Directions*

**EDITOR-IN-CHIEF/ASSOCIATE PUBLISHER**  
John C. Miklosz, Ph.D., (508) 392-2114

### SENIOR EDITORS

- Warren Andrews, *Computers & Subsystems*  
(508) 283-2102
- Barbara Tuck, *ASICs & ASIC Design Tools*  
(516) 473-1661
- Michael G. Donlin, *CAE/CAD Tools*  
(508) 392-2123
- Tom Williams, *Software & Development Tools*  
(408) 335-5514
- Dave Wilson, *Integrated Circuits*  
(508) 392-2176

### SECTION EDITOR

Jeffrey Child, *New Product Highlights*  
(508) 392-2126

### CONTRIBUTING EDITOR

Stephan Ohr, *Analog & Mixed-Signal*  
(908) 232-1380

### MANAGING EDITOR:

Arlyn S. Powell, Jr.

### CHIEF COPY EDITOR:

Annette M. Staron-Wilson

### ASSISTANT EDITOR:

Lisa A. Coleman

### PRESENTATION MANAGER:

Richard Sarno

### EDITORIAL ASSISTANT:

Claire Ellis

### ART DIRECTOR:

Jan Horner

### ILLUSTRATOR:

Manuel King

### AD TRAFFIC MANAGER:

Kelly Rice, (508) 392-2198

### CIRCULATION DIRECTOR:

Robert P. Dromgoole, (918) 832-9213

### CIRCULATION MANAGER:

Paul Westervelt, (918) 832-9287

### REPRINTS:

June Bozarth, (918) 835-3161

### PUBLISHER

David L. Allen, (508) 392-2111

### ASSOCIATE PUBLISHER/ NATIONAL SALES MANAGER:

Tim L. Tobeck, (508) 392-2116

**PennWell**  
PUBLISHING COMPANY

Advanced Technology Group  
Dr. Morris R. Levitt, Senior Vice-President  
Leslie P. Cypret, Vice-President, Administration  
One Technology Park Drive  
P.O. Box 990  
Westford, MA 01886  
Tel: (508) 692-0700  
Fax: (508) 692-0525

Postmaster: Send change of address form 3579  
to COMPUTER DESIGN Circulation Department,  
Box 3466, Tulsa, OK 74101



**CLOCK GENERATION AND SUPPORT**

# Minimize clock skew.

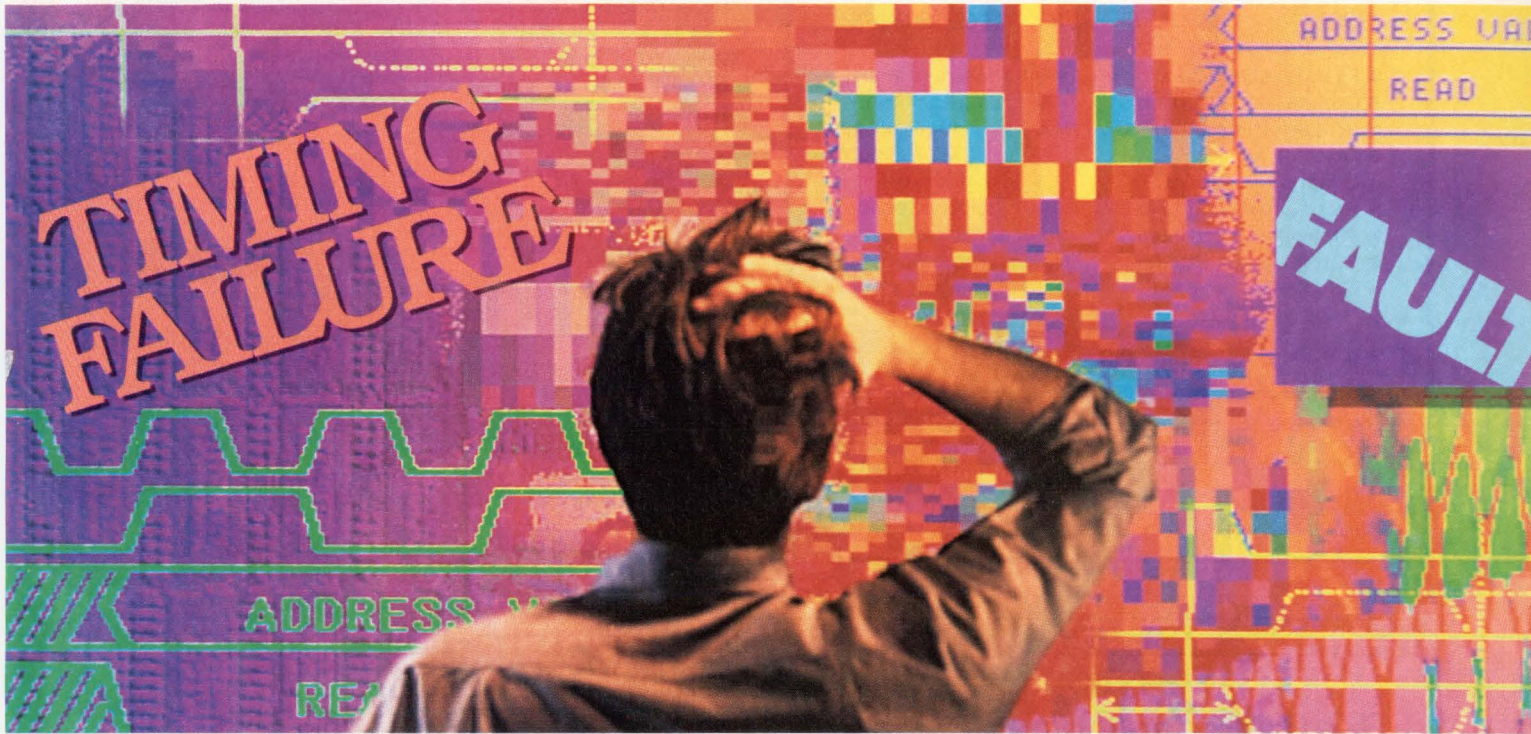

## With a minimal loss of sanity.

Designing a system clock for a high-performance application can be the ultimate exercise in frustration.

Unless you begin by calling National. Our new family of advanced CGS™ (Clock Generation and Support) products includes

**FEATURES**

- Typical pin-to-pin skew:
  - ECL: 50-150ps
  - CMOS: 100-200ps
  - Bipolar: 200-400ps
- Extensive development tool support
- Future CGS products in development

bipolar, CMOS and ECL clock drivers tested and guaranteed for minimum skew. They meet the requirements of high-end microprocessors: duty cycle, skew, and edge rates.

And they're supported with the development tools you need to simplify your end-system design: SPICE models and a CGS design handbook that includes derating curves.

All of which means you can actually minimize skew while



optimizing system speed and performance. Without losing your wits.

**Protect your sanity.  
Call National today.**

For more information on our CGS2525, CGS2526 and 100115 clock drivers, call 1-800-NAT-SEMI, Ext. 177.

# AMX™

## REAL-TIME MULTITASKING KERNEL

8086/88, 80x86/88  
80386

68000/10/20  
Z80, 64180, 8080/85

- Fast, reliable operation
- Compact and ROMable
- PC peripheral support
- DOS file access
- C language support
- Preemptive scheduler
- Time slicing available
- Configuration Builder
- Complete documentation
- Intertask messages
- Message exchanges
- Dynamic operations
  - task create/delete
  - task priorities
  - memory allocation
- Event Manager
- Semaphore Manager
- List Manager

**IDA**

No Royalties

Source Code Included

INSTANT DATA ACCESS (IDA) DIAL (617) 494-8338 DOCUMENT NO. 1038

Manual only \$85 US  
AMX 86 \$3000 US  
(Shipping/handling extra)

**KADAK Products Ltd.**

206-1847 West Broadway  
Vancouver, B.C., Canada  
V6J 1Y5



Telephone: (604) 734-2796  
Fax: (604) 734-8114

Call for prices for  
other processors.

CIRCLE NO. 12

RTMX X Window System

## RTMX

### RealTime, Multi-platform Unix

- Realtime fixed priority tasking
- Derived from Berkeley 4.3 Unix
- X11R5 plus Motif
- Full Networking with TCP/IP and OSI Protocol Support
- POSIX 1003.1 Compliant
- Demand-Page, Virtual Memory System
- Source Compatible with Sun Unix
- BSD4.3 Socket Library

RTMX is standardized. POSIX compliance assures consistent, portable code for now and for the future. X Windows provides you, the developer and user, with the most powerful graphical user interface available. Supports Intel, Motorola, MIPS, and SPARC processors.

*Realtime tasking gives you, finally, what we have all wanted...a real system -- and realtime performance!*

RTMX/RN is priced at \$995 U.S. and the RTMX/XW system, with X Windows, is \$1895 U.S.

For more information:

### RTMX Inc.

800 Eastowne Drive, Suite 111  
Chapel Hill, NC 27514

Phone: (919) 493-1451

Fax: (919) 490-2903

Email: krl@rtmx-uniflex.com

CIRCLE NO. 13

## CALENDAR

### CONFERENCES

June 8 - 11

DAC



Anaheim Convention Center, Anaheim, CA. The 29th Design Automation Conference is geared toward electrical engineers, computer scientists and management, and will offer technical programs, tutorials and vendor exhibits. New at DAC are sessions on real-world EDA user problems and solutions targeted at high-level company executives. User sessions include "Why is today's CAD inadequate for designing tomorrow's computers?" Contact: MP Associates, 29th DAC, 7490 Clubhouse Rd, Ste 102, Boulder, CO 80301, (303) 530-4333, Fax (303) 530-4334. **Circle 366**

June 16 - 18

Nepcon East '92



Bayside Exposition Center, Boston, MA. This conference will feature products and technologies for the design, fabrication, assembly, packaging, inspection, and testing of printed circuits and electronic assemblies. Technical session topics address surface-mount technology, pollution problems when switching from solvent cleaning, concurrent engineering, and surface-mount components. There will also be a workshop on low-volume SMT. Contact: Reed Exhibition Companies, Cahners Plaza, 1350 E Touhy Ave, Des Plaines, IL 60018, (708) 299-9311, Fax (708) 635-1571. **Circle 367**

June 23 - 25

AFCEA 46th International Convention  
& Exposition and ITEMS '92



Washington Convention Center, Washington, DC. This convention is the world's largest communications, intelligence and information systems event. The show focuses on professional development and information exchange for military, government and industry personnel. Panel topics include: "The electronic battlefield: tomorrow's approach to training, rehearsing and testing," and others. Also AFCEA will launch Imaging Technologies & Evolving Management Systems Conference and Exposition (ITEMS), featuring the latest imaging software and hardware. Contact: AFCEA Programs Office, AFCEA International Headquarters, 4400 Fair Lakes Ct, Fairfax, VA 22033-3899, (703) 631-6125, Fax (703) 631-4693. **Circle 368**

July 6 - 9

Professional Developers Conference



Moscone Center, San Francisco, CA. Microsoft is holding a technical pre-release conference focusing on 32-bit Windows development for professional, commercial and corporate developers. General sessions will cover Win32 API (including Win32s), Windows NT and development tools. More than 40 breakout sessions will feature tracks on Win32 development, the Windows programming environment, development tools, corporations and Win32, writing device drivers for Windows, international localization, and Windows extensions. Contact: (800) 227-4679. **Circle 369**

# ARTFUL SOLUTIONS *VME*

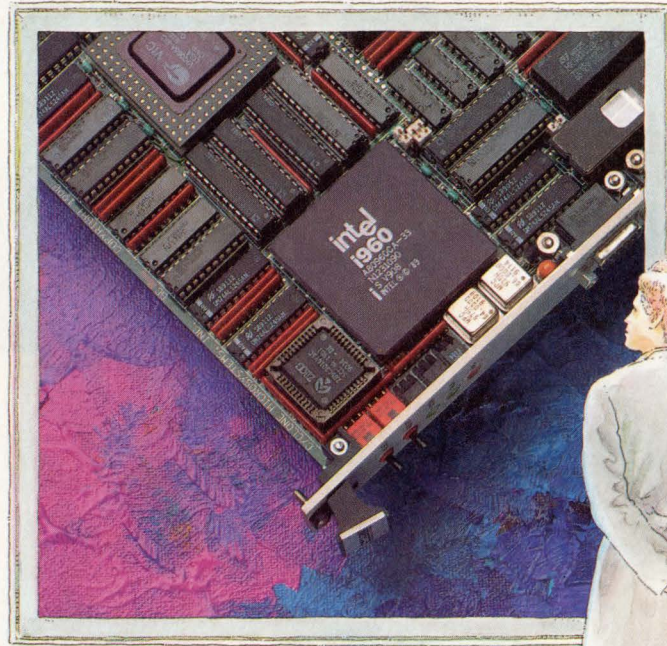

Advanced hardware is just the beginning.  
Cyclone Microsystems completes the development picture with C and Ada compilers, VxWorks and pSOS+ real time environments, source level debuggers, and a fantastic team of support engineers, waiting to help you create a masterpiece.

**CYCLONE**  
MICROSYSTEMS

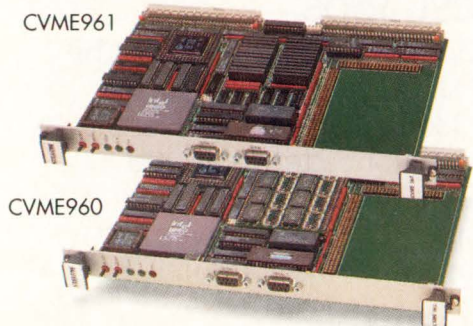

ISDN

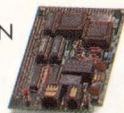

Fiber

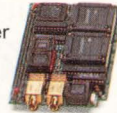

VSB

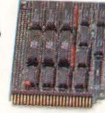

SCSI2

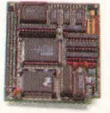

Serial

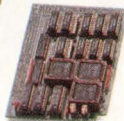

T1/E1

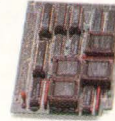

Ethernet

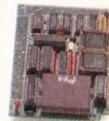



# The Official Flag Of The

## AMD Delivers The World's Fastest 386s.

The great 386 race is over. And the clear winner is the Am386 microprocessor family.

The fact is, no other 386 microprocessors available today can rival the sheer speed and performance of the Am386 microprocessors. The Am386DXL-40 CPU brings 40MHz,

full 32-bit 386 performance to the desktop. The Am386SXL-33 CPU makes 33MHz the standard for 386SX machines both at the desktop and for battery powered applications.

In either case, they're over 20% faster than those run-of-the-mill 386s.



*The 40MHz DXL-40 and the 33MHz SXL-33 are available in low-cost PQFP packaging.*



# Am386 Microprocessors.

And of course, they're proven-compatible with the IBM® standard.

Best of all, they're available now, available in quantity, and available at surprisingly low prices.

So don't just keep up with the competition with ordinary 386 systems. Blow them away with the world's fastest 386 systems—built around the Am386 microprocessors from Advanced

Micro Devices. Call **1-800-222-9323** for more information.



**Advanced Micro Devices**

*"We're Not Your Competition."™*

is a trademark of Advanced Micro Devices, Inc. All brand or product names mentioned are trademarks or registered trademarks of their respective holders.

**CIRCLE NO. 15**

# So Much Real-Time Power. Such A Small Package.



Pick up these ROMs and you're in touch with the world's most powerful real-time 680X0 system software solution—OS-9®.

But OS-9 is so much more than just a powerful real-time kernel. Check out this *Critical Features Checklist* to find out how OS-9 can give you "Real Time In No Time."

CRITICAL FEATURES CHECKLIST		
Real-Time Operating System Features	Robust Development Environment Features	Sophisticated I/O Features
Compact (28K), high-performance real-time kernel for demanding applications Uses UNIX process and I/O models Multi-user, multi-tasking, pre-emptive scheduler Modular architecture User-installable system calls Interprocess communication facilities: <ul style="list-style-type: none"> <li>semaphores</li> <li>pipes</li> <li>signals</li> <li>events</li> <li>shared memory</li> </ul>	UNIX-hosted development (UniBridge) PC-DOS-hosted development (PCBridge) Complete 680X0 development capabilities: <ul style="list-style-type: none"> <li>highly-optimizing ANSI C compiler, assembler/linker</li> <li>C source level and system level debuggers</li> <li>PVCS source code control system</li> <li>advanced shell interface (MShell)</li> </ul>	Hard and flexible disk support, SCSI Common Command Set Tape support WORM support Networking: <ul style="list-style-type: none"> <li>Ethernet (IEEE 802.3)</li> <li>NFS Version 2</li> <li>ARCNET (SMC Data Point)</li> </ul> Graphics: <ul style="list-style-type: none"> <li>X Window System V11R4</li> <li>OSF/Motif Version 1.1.1</li> <li>RAVE for real-time graphics and multimedia</li> </ul>

Also, ask us about OS-9000® for 386/486 and RISC processors.

## Grab the Power.

So get your hands on these ROMs that have been proven in thousands of specialized and demanding 680X0 applications. Call Microware® today to put OS-9 to work for you.

**1-800-475-9000**

**Call Microware Today!**

In California, call (408) 980-0201

MICROWARE SYSTEMS CORPORATION

1900 N.W. 114th Street • Des Moines, Iowa 50325-7077  
 England / Benelux: (44) 703 601990  
 France / Spain / Italy: (33) 42.58.63.00  
 Germany: (49) 6221-862091 • Sweden: (46) 18-192990  
 Switzerland: (41) 56-83-3377

**MORE CHOICES • MORE OPTIONS • TOTAL SUPPORT**

CIRCLE NO. 16



# Cyrus Y. Tsui on: Programmable logic

**G**iven the rapid pace and great diversity of the computer industry, it's sometimes difficult for those of us in the trenches to stand back, take stock of the past and apply lessons learned to the many possible directions of our future. We can be forgiven for attaching great importance to our own particular subfields at the expense of others, especially in view of the rich contributions made by every sector in furthering speed, flexibility, affordability, and market growth. At the risk of being accused of such a narrow focus, I want to suggest that some of the most important developments of this decade will be the result of innovations to come in programmable logic.

Obviously, no one can accurately predict the future. But the programmable logic industry, now nearing its 20th birthday, has accumulated the kind of wisdom that comes with age and experience. While the field can still be considered young and burgeoning, significant innovations are commonplace, and we can now look to the past as a window on our immediate future.

Today there are programmable logic technologies competing for the attention of designers that are stupendous in their sophistication and capabilities, each promising massive potential rewards for marketers and end-users alike. Even considering the potential, however, it's my conviction that the greatest innovation—indeed, a fundamental shift in the programmable logic paradigm—is yet to come and will occur in this decade.

## Four key lessons from history

Driving this fundamental paradigm shift will inevitably be scientific breakthroughs. These breakthroughs will be expedited by the wisdom gained from four key lessons learned in our 20-year history.

John Birkner, a product planner at Monolithic Memories Inc. (MMI), found PLAs, the original programmable logic devices, to be large, cumbersome and slow. He proposed the first PAL, a device that would be smaller, faster, field-programmable, and significantly easier to use. As with many new product ideas, the PAL architecture wasn't met with applause when



it was proposed to the MMI design community. MMI designers saw it as a step backward. It was viewed as a subset solution of the PLA problem, and far less flexible from an architectural standpoint.

However, H. T. Chua, a newcomer to MMI's design department at the time, began to see the possibilities that this new device held. Together, Birkner and Chua implemented the idea in silicon and went forward to produce the PAL device, the first PLD standard.

The team successfully overcame entrenched objections to bring the new paradigm to life. But more important, the new paradigm was made possible by Chua's openness to the idea, no matter how farfetched it seemed to others. Had he sided with the rest of the MMI design community and decided that Birkner's concept didn't warrant further consideration, the history of the PLD would have been dramatically different—and quite possibly nonexistent.

The first lesson from history, then, is the need for champions—individuals with the ability and willingness to step outside of conventional thought and authorize the prudent exploration of a new concept until it has been accredited or exhausted.

Unfortunately, in many corporate environments inertia often makes it easier to dismiss a new idea because "it's never been done that way" and, therefore, it can't possibly work. This deadly attitude can open the door to a flood of smart, nimble competitors who can easily exploit this kind of entrenchment. At MMI in the mid-1980s, for example, we looked at CMOS technology for the PAL architecture simply because of the high volume required, rather than fully exploring the potential advantages that the new technology might bring to bear. Today, less than a decade later, CMOS is the dominant technology. AMD has

*Cyrus Y. Tsui is president and CEO of Lattice Semiconductor Corporation, Hillsboro, OR*

found itself with a host of new competitors, my company among them, and the PAL device is no longer the only PLD standard.

When organizations let champions flourish and new ideas proliferate, they make it possible for the next generation of Birkners and Chuas to emerge, and potentially stimulate the next important advance in PLD technology.

**Benefits, not specs, determine success**

A champion embraces and promotes a new idea for what it is: a technology, a design or a departure from the past. In many cases, the tactical and market forces that can fully develop a blossoming idea remain obscured. Consequently, the champion can only be viewed as a partial solution.

position in the marketplace. That's the second lesson history teaches us.

In-system programming (ISP), or the ability to program and reprogram a device while on a circuit board or *in-system*, is an excellent example of a technology focused on risk reduction. The concept of ISP isn't new in the computer field; the dynamic RAM in millions of personal computers used worldwide illustrates this concept perfectly. Memory is programmed over and over again as new data is obtained and stored. When put in the context of logic, however, ISP represents a dramatic breakthrough with tremendous potential for market expansion.

The mechanics of this technology are of relatively little interest to most customers. Few will explore the product specifics in terms of circuitry or the

processing technology that makes it all possible. What matters to the user is that ISP technology lets the manufacturing department program or reprogram boards after they are built. Design corrections can be made without reworking the board. New product features can be added to hardware via a software upgrade. What matters is that the in-service programming of PLDs now represents the best means available of reducing risk, limiting nonrecurring costs and accelerating the time it takes to bring complex electronic products to market. With customer vision, ISP technology can change the program-

**Evolution of PLD standards**

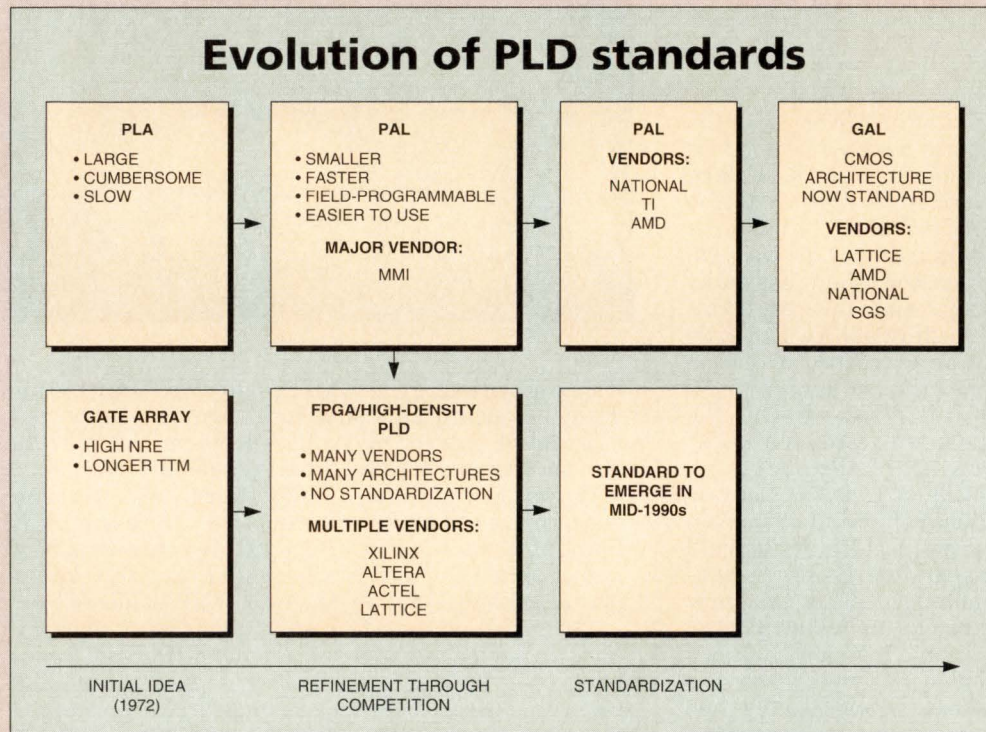

Our own PLD market is a perfect illustration of this phenomenon. While the PAL device was a marvelous product in itself, the customer ultimately defined the product and the market. We thought we were selling field-programmable silicon; our customers were buying risk reduction and faster time-to-market.

Today, rapid developments in PLD technology and increased competition have sparked a virtual "war of specifications" in which the relative merits of E<sup>2</sup>CMOS, SRAM and antifuse or differing device architectures are widely debated. While these developments make for good advertising copy and headlines, they haven't substantially changed the commodity our customers wish to purchase.

I'm convinced that any technological advance in the programmable logic industry, whether expressed in throughput, density, cycles, or any other attribute, must speak to the issues of risk reduction and time-to-market. As we look to the future, technologies that make the most of these qualities and maximize their inherent benefits to customers will enjoy a dominant

mable logic market into the reprogrammable logic market.

These qualities, not specifications in silicon, are what drive the market—and determine what customers ultimately buy.

**Competition will clean up your market**

As a market expands, it becomes attractive. Each new entrant has the advantage of watching the technology develop in the early stages of market acceptance. This typically results in a dozen or so new products and competitors, each pursuing the original market opportunity with a slightly different slant, from a slightly different vantage. This was clearly the case in the PLD industry as we saw the original PAL product replaced by the now-dominant CMOS GAL device. As a result, the once-dominant PLD makers have taken a backseat in the most rapidly expanding market segments.

There are many lessons to be learned about competition from the makers of the PAL device.

MMI/AMD was one of the first high-technology companies to protect its intellectual property in this area. In the mid-1980s, for example, the company brought suit or the threat of suit against at least a dozen companies for infringement of the original PAL device patent. In this case, litigation was used not only to protect the company's property, but also to literally define the competitive playing field. As a result of suits brought against its competitors, MMI/AMD gained access to patents and technologies otherwise unavailable to the company—not the least of which was the GAL device from Lattice Semiconductor. In addition, litigation served as an offensive weapon by preventing easy market access to foreign competitors. The programmable logic industry, like the micro-processor market, is one of the few billion-dollar industries without significant foreign competition.

Another lesson comes from the ability (or inability) of an innovative company to watch market trends while focusing on product or market development. Many companies have good ideas and enjoy the rewards of those ideas for only a short time. Few are able to continually adapt those ideas to meet the changing competitive threat and customer demands. A company that's inwardly focused ignores the subtle messages that herald technological opportunity. It misses quick acceptance of competitive technologies and dismisses small, unknown competitors. Perhaps the high-density PLD market lacks large, potentially dominant suppliers for just this reason.

Any lesson on the potential threat of competition would be incomplete without mentioning a life-threatening disease affecting most companies at virtually every level. The "not invented here" syndrome is prevalent within many American companies. The American dream was built on ingenuity and innovation. A loose translation might be that fresh ideas are the only ones with the big payoff. We as a nation have trouble seeing innovation in refinement or optimization of an already great idea. As a result, it's very tempting to "roll the dice" on that new and potentially risky idea. An old idea isn't necessarily a bad idea. At the risk of offending our noble neighbors to the East, Japan has built a world economy on refining old ideas with timely market execution. It's important to recognize when a design, manufacturing or marketing idea shouldn't be reinvented.

### ■ The market makes the standard

The PAL standard encompassed many different devices. In essence, multiple standards were housed under a generic PAL architecture. The high-density market is awash with competitors, many of whom are new to the programmable logic arena. Each company is currently expounding the architectural advantages of its devices. Clearly each of these vendors—and Lattice is no exception—is competing

to be the next market standard. But a standard is rarely set by an individual company. A product becomes a standard by being recognized by the company's customers and legitimized by the competition. That's the last key lesson.

PAL and GAL devices have each attained the status of industry standards. But they wouldn't have attained this status if the market hadn't responded

## Programmable logic history

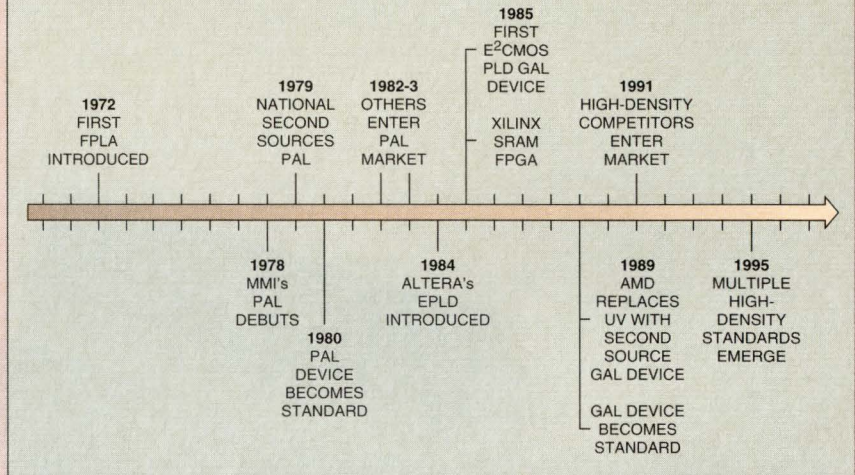

favorably to the product concept and competitors hadn't adopted the product architecture. Although there are companies within the high-density PLD market enjoying significant market dominance, neither customers nor competitors have embraced any of their architectures as an industry standard. As a result, there are at least a dozen different competing companies and technologies in this rapidly expanding market, with additional emerging competitors.

A device standard isn't likely to emerge soon in the high-density PLD market, either. The programming elements and device architectures vary too greatly. The diversity of technologies will probably first result in multiple PLD product standards. Groups of products or technologies will compete to be the standard in speed-intensive applications. Others will compete for applications requiring high utilization. And still others will compete in terms of advanced features such as ISP. In other words, device technologies and product architectures will evolve to best serve their own market niches.

I do believe, however, that we'll see a new industry standard for high-density programmable logic by the end of this decade. It will probably be marked by a drastically different architecture and process technology; the product evolution readily observable in today's market will not take us there.

By the year 2000 this market will have seen unbelievable, unpredictable changes. Although historical introspection can't necessarily help predict the future, it can help avoid foolish mistakes of the past. The next "big idea" in programmable logic will come from the company that's both technologically focused on customer needs and flawless in its execution. May the best company win!

# Low Delays.

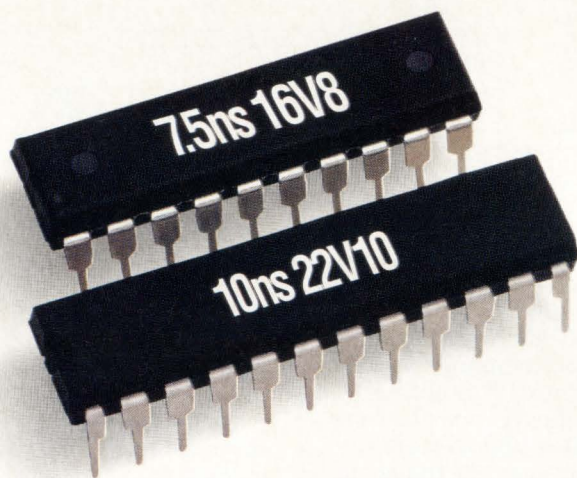

## **High-Speed 7.5ns CMOS PAL® Devices.**

There's nothing we hate more than delays. That's why we developed high speed CMOS PAL devices that no one can beat—our CMOS 7.5ns 16V8H-7 and 10ns 22V10H-10 PAL devices.

In fact, nobody even comes close to our in-system performance, with the fastest set-up

and clock-to-out times available. Both come in PLCC and DIP varieties. All on state-of-the-art submicron EE CMOS.

## **High-Volume, High-Speed Delivery.**

Again, there's nothing we hate more than delays. You can get huge volumes of our new CMOS PAL devices now.

And they're on the shelf at your local dis-

# No Delays.

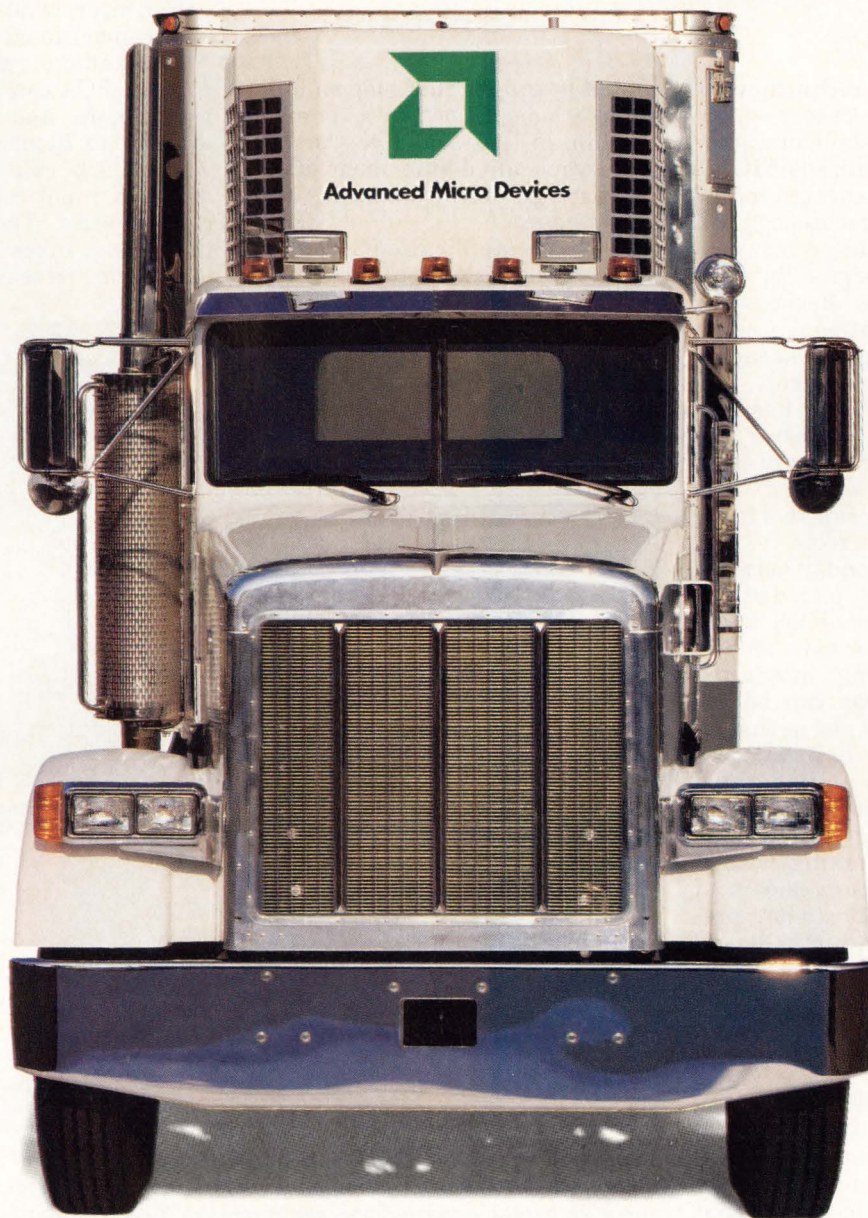

tributor, too. So you can get the quantity and speed you need, whenever you need them.

What more can you expect from the company that sells more programmable logic than all of its competitors combined?

So pick up the phone and place your order today, or call **1-800-222-9323** for more information.

Because at AMD, we don't believe in long delays either.



**Advanced Micro Devices**

901 Thompson Place, P.O. Box 3453, Sunnyvale, CA 94088 © 1991 Advanced Micro Devices, Inc. PAL is a registered trademark of Advanced Micro Devices. All brand or product names mentioned are trademarks or registered trademarks of their respective holders.

## ASIC core brings fuzzy logic to semiconductors

Tom Williams, Senior Editor

**A** licensable core technology for fuzzy logic processors is now available to semiconductor manufacturers, specialized ASIC users and vertically integrated industrial companies. The technology will allow integration of silicon fuzzy capability in custom designs. Togai Infralogic (Irvine, CA) is offering what it calls fuzzy computational acceleration (FCA) technology for licensing and custom-chip development.

For several years Togai has provided a digital fuzzy processor, the FC110, and a number of board-level products based on the FC110. The company also offers a range of fuzzy software development tools.

FCA is billed as second-generation fuzzy ASIC technology, aimed at giving manufacturers the ability to design information-intensive "smart" products around highly integrated silicon. FCA technology can be applied in three ways: as a custom ASIC incorporating a fuzzy core with custom logic, as an integrated processor including a conventional CPU core with a fuzzy core or as a fuzzy coprocessor working with a host CPU. Togai's vice-president of operations, Daniel Bochsler, predicts that "semiconductor-based fuzzy technology will be as prevalent in products by the end of the decade as microprocessor technology is today."

### Scalable technology

The FCA technology is scalable from 8 to 32 bits and includes, in addition to the fuzzy processing core, rule-base and scratch-pad memories that can be built to different sizes, depending on the customer's requirements. A 10-bit implementation of the core technology, for example, can handle up to 1,024 inputs and up to 1,024 membership functions per input. Output variables can also have up to 1,024 membership functions.

Membership functions are fuzzy sets assigned to a variable to indicate degrees of belief in that variable's conditions; for example, almost empty, half full, full. Such functions are most often repre-

sented as graphs that map an input value to a degree of "truth," or membership, in that set. With the FCA core, you can define membership functions graphically to be any arbitrary shape.

Practical applications wouldn't make use of 1,024 inputs with 1,024

to address problems with a relatively small number of rules. The benefit of this hardware implementation is that it speeds up rule evaluation over what can be achieved with conventional processors.

For example, running at 20 MHz, a 10-bit FCA core in a system with eight inputs and four outputs can evaluate in 70 ms a base of 20 rules, where each rule has five antecedents, or input conditions, and two consequences. The 70 ms includes the time it takes to "defuzzify" the output, or arrive at a "crisp," unam-

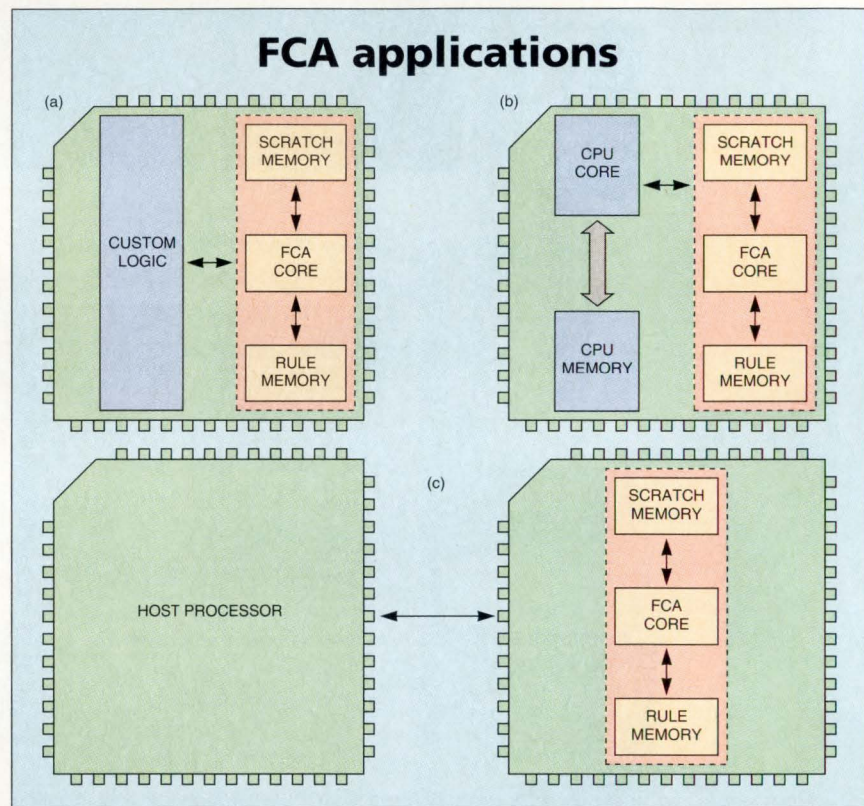

Implementations using Togai's fuzzy computational accelerator (FCA) technology include customizing ASICs to incorporate fuzzy capability (a), integrating fuzzy processing on-chip using a conventional microprocessor (b) and linking fuzzy coprocessors with a host CPU (c). FCA implementations can be from 8 to 32 bits, and can vary as in the size of rule-base and scratch-pad memories.

membership functions each; that would require enormous amounts of memory in any case. Still, the numbers indicate the flexibility of the core technology. Practical combinations of variables and membership functions are limited by available rule-base memory and the realistic needs of the application. One of the virtues of fuzzy logic is that it's able

to give a more precise and unambiguous answer. Another way of looking at the FCA's performance: the same core implementation, given a rule-base of 40 rules, each with two inputs and one output, can evaluate up to 800,000 rules per second, including defuzzification.

### Software support

For the immediate future, software



# Now You Can See True Colors Without Getting Soaked.

**New full-featured RAMDACs from Brooktree deliver 24-bit true color for cost-conscious PC designers.** Introducing four new RAMDACs that span the spectrum of PC applications, from 640x480 VGA systems to 1280x1024 workstation-quality graphics. They've got the right features, the right prices and are available right now.

### True Color In A VGA Environment

Unplug Sierra. Plug in our totally compatible Bt481 or Bt482. You'll get 24-bit performance at 16-bit prices.

These new RAMDACs support 15-bit TARGA, 16-bit 5:6:5 and 24-bit true-color formats. They even allow you to switch between VGA and true color on a pixel-by-pixel basis.

Choose the Bt481 if you prefer an external

hardware cursor. Or pick the Bt482 for its on-board 32x32x2 cursor — ideal for faster windowing environments.

### Workstation Graphics at PC Prices

Introducing the Bt484 and Bt485, our newest mouth-watering RAMDACs. They combine true color with higher resolutions for higher performance graphics subsystems. And they're economical, too.

Bt485 operates at up to 135 MHz to drive pseudo color to 1280x1024 resolutions and gamma correct true color to 1024x768. It has a 64x64x2 cursor and all the serialization and timing to directly interface to a VRAM frame buffer.

Bt484 provides maximum flexibility with its programmable pixel port to provide 256

to 16.8 million colors, on-board 32x32x2 cursor and supports both interlaced and non-interlaced monitors.

Bt		Resolution			
		640x480	800x600	1024x768	1280x1024
Colors	16.8MT 64K 256	Bt481/Bt482			Bt485
		Bt484/Bt485			Workstation RAMDACs

Call Brooktree at **1-800-VIDEO-IC** for technical details and pricing today.

Brooktree Corp., 9950 Barnes Canyon Road, San Diego, CA 92121, (619) 452-7580, FAX (619) 597-0673.

## Brooktree®

Considering

# Multimedia or Interactive Systems ?

Consider **MICROBOARDS**

Authoring systems for:

- DOS, Mac, UNIX, OS-9, CD RTOS
- Player Hardware

Red Book

Yellow Book

Green Book

Orange Book

Standard and Custom OEM designs



MBi America

Tel: (612) 448-9800

Fax: (612) 448-9806

MBi Japan

Tel: 0474 (37) 9811

Fax: 0474 (37) 9821

CIRCLE NO. 19

## Drive Enclosures

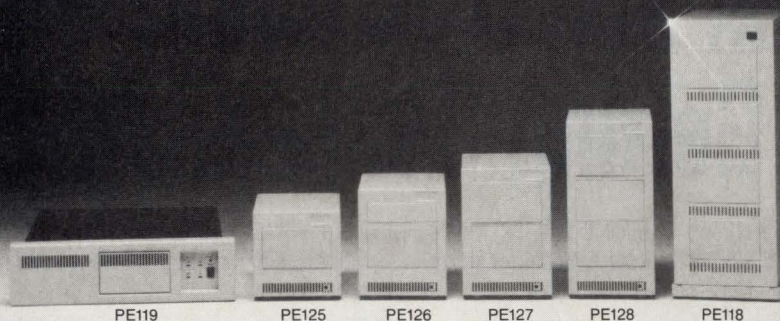

### MOUNTING:

- 1 to 6 Full Height 5.25" Drives
- 2 to 12 Half Height 5.25" Drives
- 3.50" and 5.25" Combinations

### SUPPORT:

- Hard Disks ▪ Floppies
- Optical Disks ▪ CD-ROM
- 1/4" Tape ▪ 4mm DAT TAPE
- 8mm EXABYTE

### POWER:

- Up to 400W  
(UL/CSA/VDE Approved)

All enclosures feature flexible I/O rear connector panels to accommodate standard interfaces such as ST506, ESDI, SCSI, and SCSI II.

A wide range of optional equipment is available to customize any enclosure.

Enclosures are designed to complement DEC, IBM, SUN, and VME style packaging.

Call us today for more information or design assistance.

DEC is a registered trademark of Digital Equipment Corporation. IBM is a registered trademark of International Business Machines. SUN is registered trademark of Sun Microsystems.



173 Freedom Ave. ▪ Anaheim, CA 92801  
(714) 525-8795 ▪ FAX (714) 525-9310

CIRCLE NO. 20

## INTEGRATED CIRCUITS

development for the FCA will depend on tools already offered by Togai, according to Douglas Leo, Togai's manager for VLSI and hardware development. TILShell, for example, is a graphics-based development environment that lets you graphically design inputs and outputs and process objects for a fuzzy system; it also lets you draw membership functions, write and edit

***"Semiconductor-based fuzzy technology will be as prevalent in products by the end of the decade as micro-processor technology is today."***

—Daniel Bochsler, Togai Infralogic



rules and compile code. One of the formats output by TILShell is Togai's Fuzzy Processing Language (FPL).

Togai has developed a new rule-base format for use with the FCA technology, so there will be a tool to convert FPL files into this new format. Run-time generators will be developed for each custom FCA design that is licensed to a customer. These will let you convert the rule-base files from a general format into run-time binaries for individual FCA implementations.

"At this point," says Leo, "there has been no decision on third-party tools." That is to say, the company isn't at this point providing a means for developers to use tools other than Togai's to develop FCA-based applications. ■

*For more information about the technologies, products or companies mentioned in this article, call or circle the appropriate number on the Reader Inquiry Card.*

Togai Infralogic

(714) 975-8522 ..... Circle 211



# Use our low power, low voltage memory and buy more time.



If you design battery operated systems such as laptop and notebook computers, Micron's low power, low voltage memory components can buy you more time.

Micron's extensive line of leading edge, low power, low voltage DRAMs and SRAMs are designed to give you optimum 3.3 volt operation in battery powered systems,

extending battery life and system operating time. Since the parts run cooler, they also increase system reliability. And we offer the latest packaging technologies such as TSOP and PQFP.

So call Micron today at 208-368-3900. And find out how to buy more time.

Micron. Technology that works for you.

Part Number	Memory Configuration	Availability	Part Number	Memory Configuration	Availability
<b>3.3 Volt, Low Power, Extended Refresh DRAMs</b>			<b>3.3 Volt, Low Power Specialty SRAMs</b>		
MT4C4001J VL	1 Meg x 4	3Q92	MT5LC2818 Latched	16K x 18	Now
MT4LC4001 S*	1 Meg x 4	4Q92	MT58LC1618 Synchronous	16K x 18	Now
MT4LC4001 L	1 Meg x 4	4Q92	MT5LC2516 Latched	16K x 16	Now
MT4C4256 VL	256K x 4	Now	MT58LC1616 Synchronous	16K x 16	Now
<b>5 Volt, Low Power, Extended Refresh DRAMs</b>			<b>5 Volt, Low Power, Low Voltage Data Retention SRAMs</b>		
MT4C1004J L	4 Meg x 1	Now	MT5C1001 LP	1 Meg x 1	Now
MT4C4001J L	1 Meg x 4	Now	MT5C1005 LP	256K x 4	Now
MT4C8512 L	512K x 8	3Q92	MT5C1008 LP	128K x 8	Now
MT4C16256 L	256K x 16 DW <sup>1</sup>	3Q92	MT5C2561 LP	256K x 1	Now
MT4C16257 L	256K x 16 DC <sup>2</sup>	3Q92	MT5C2564 LP	64K x 4	Now
MT4C1024 L	1 Meg x 1	Now	MT5C2565 LP	64K x 4 OE <sup>5</sup>	Now
MT4C4256 L	256K x 4	Now	MT5C2568 LP	32K x 8	Now
MT4C1664 L	64K x 16 FPM <sup>3</sup>	Now			
MT4C1670 L	64K x 16 SC <sup>4</sup>	Now			

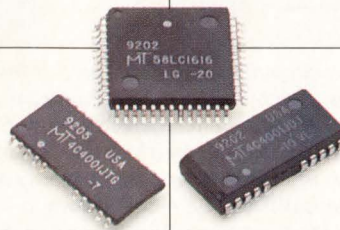

\*Self Refresh    <sup>1</sup>DW- Dual Write Enable    <sup>2</sup>DC- Dual CAS    <sup>3</sup>FPM- Fast Page Mode    <sup>4</sup>SC- Static Column    <sup>5</sup>OE- Output Enable

**MICRON**  
TECHNOLOGY, INC.

2805 E. Columbia Rd., Boise, ID 83706 (208) 368-3900  
Customer Comment Lines: U.S. 800-932-4992; Intl: 01-208-368-3410

© 1992 Micron Technology, Inc.

CIRCLE NO. 21

## Setting the record straight on SRAM loading

Dave Wilson, Senior Editor

**M**ichael Davis, formerly a product marketing engineer at Cypress Semiconductor (San Jose, CA), believes that certain SRAM manufacturers are involved in the process of specifying the speed of their SRAMs with zero capacitance load on their outputs—a process that makes them look faster than they might operate in an actual design environment. Indeed, it's not hard to find engineers that agree with him. John Peters, technical director of VMEbus products at Performance Technologies (East Rochester, NY), a VME and SBUS bus-board design house, is one of them. He says that such underhanded practices are commonplace. "Playing the game of changing the capacitive loading to improve the performance specifications of devices is quite common. I've seen that game played in a lot of different places, not just with SRAMs. PAL vendors are good at that, too," he says.

### ■ The other side of the argument

David Chapman, applications manager for fast SRAMs (FSRAMs) at Motorola (Austin, TX), takes umbrage at Davis' statement, however. He argues that the capacitive load becomes irrelevant as the speed of SRAMs becomes faster. "The ac test load diagram that fast SRAM vendors have traditionally put into their data sheets has been around since the days of 55-ns SRAMs. Since then, SRAMs have gotten considerably faster. As a consequence, the test environment has started to behave as if it were a transmission line. At that point, the lumped capacitive effects go away," he says.

But do they? Many designers don't know. "Since we don't have the elaborate test fixtures, we have to trust the SRAM vendors," says Dean Moss, an engineer at Diversified Technology (Ridgeland, MS). "We are held at the mercy of what those guys tell us." While Moss agrees with Motorola's Chapman that test fixtures are antiquated, especially for under-12-ns SRAMs, he finds it

hard to believe that the capacitive component is of no consequence.

### ■ His proof's on paper

Motorola's Chapman has put forth his arguments in detail in a paper called "Regarding SRAM Specmanship." In it he shows the ac test load that's traditionally printed in SRAM data sheets, as well as a load that looks more like a transmission line load—one he claims should better describe the behavior of FSRAMs. He says that once the RAM begins "swinging its outputs fast enough,"

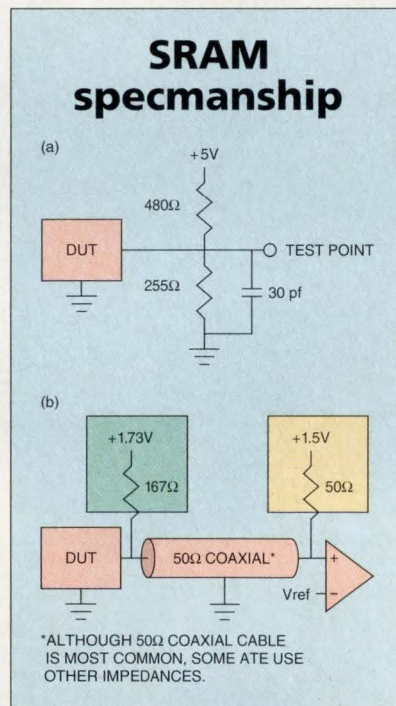

*The traditional lumped capacitive ac test load is used by many manufacturers as a way to specify the test environment of SRAMs; it's diagrammed in (a). As SRAM speeds increase, this model gives way to the transmission line model shown in green (b). Here, capacitive loading of the device becomes less important. The ac test load diagram used by Motorola's SRAM operation shown in yellow (b) uses a 50 Ω termination resistor and a 1.5-V supply, requiring two to three times more dc current drive than the transmission line model.*

the capacitive effects "disappear." They are "replaced" or "overcome" by transmission line effects.

Don't believe that just because the capacitor may "disappear" as a function of the SRAM's speed, vendors who continue to use the traditional loading diagram in support of their SRAMs haven't bothered to test them with a real capacitive load. Many, such as Cypress and Toshiba, still use a 30-pF capacitor as the test load, even on their faster parts, just to conform to a standard—the philosophy being that any standard, poor or not, is better than none at all.

### ■ Which model to use?

But for what class of devices is the lumped capacitive model ineffective? Where is it more appropriate to use the transmission line model? Tom Baillio, senior development engineer at Mercury Computer Systems (Lowell, MA), has some answers. He says that the lumped-load/transmission-line crossover point has more to do with SRAM edge rates than it does with access times.

The transmission line effects, according to Baillio, are more a result of the speed at which the output buffers in the SRAM switches from a 1 to a 0 state, or vice versa. "That rate will give you an indication of whether you are looking at a transmission line or a lumped load," says Baillio. "The line begins to look more like a transmission line as the edge rates of the SRAMs fall. Typically, an etch in a circuit looks more like a transmission line than a lumped load when the round-trip propagation delay of the signal along that line is less than either the rise or fall time of the SRAM. That's when you start to see reflections back from the remote termination of the line."

The ac test load diagram used by Motorola's FSRAM operation is a good representation of the actual test environment in both physical and electrical terms, according to Chapman. Note the difference between the ac test load diagram for a transmission line and that for the Motorola FSRAM. In the former, the load resistor is set to 167 Ω with a 1.73-V load voltage, a combination that behaves identically to the resistive portion of the circuit in the test load diagram usually attributed to SRAMs.

Unfortunately, Chapman says,

when signals are fast enough for transmission line effects to come into play, failure to terminate the transmission line that runs back to the automatic test equipment's comparator in its characteristic impedance introduces noise into the circuit. The noise can make the SRAM appear to be either faster or slower than it actually is, complicating correlation between testers and the test environment. Chapman notes that the 50 Ω termination resistor tied to the 1.5-V line used in the test load diagram for the Motorola FSRAM

board, allowing both the trace lengths and the number of devices that will be driven to be taken into account.

Of course, there will be those designers that may not have the time or who can't go to the trouble of getting Spice models. They'll just

have to use extremely conservative design rules in their memory designs and keep their fingers crossed that they don't run into any transmission line problems. ■

***"Since we don't have the elaborate test fixtures, we have to trust the SRAM vendors. We are held at the mercy of what those guys tell us."***

—Dean Moss, Diversified Technology



adds another layer of conservatism into the design, since it requires two to three times more dc current than the environment shown in the test load diagram for the transmission line.

■ **It may not matter**

Unfortunately for the argumentative, it may be all moot anyway. Most SRAM vendors—Cypress and Motorola included—say their customers prefer to have a Spice model of their SRAMs and then simulate the loading effects in the particular application. After all, using Spice lets you model the exact kind of parasitic capacitances that will be seen on a

*For more information about the technologies, products or companies mentioned in this article, call or circle the appropriate number on the Reader Inquiry Card.*

- Cypress Semiconductor (408) 943-2600 ..... Circle 201
- Diversified Technology (601) 856-4121 ..... Circle 202
- Mercury Computer Systems (508) 458-3100 ..... Circle 203
- Motorola (512) 928-6000 ..... Circle 204
- Performance Technologies (716) 256-0200 ..... Circle 205



**Prime Real Estate Available in a Great Location.**

Locate your next product on a VME MXbus™ SideCard™ adjacent to a Mizar CPU card and you get your product to market faster because you start with an off-the-shelf CPU that comes up with the debugger the first time you power it on. And if you want to use a commercially available real-time OS, it is probably already ported to the board.

By building your custom design on a proven hardware and software foundation you also minimize your design risk. But you need not sacrifice any design flexibility because Mizar supplies a variety of configurations based on Motorola processors, including the 040. And the VME MXbus™ accommodates single high 3U, conventional double height 6U, as well as unconventional 9U and custom configurations.

Call us today to take advantage of this opportunity to put your next design in a great location. It's a unique solution from Mizar that you can build on.

**MIZAR**

1419 Dunn Drive • Carrollton, TX 75006  
1-800-635-0200 FAX 214-242-5997

© 1992 Mizar Digital Systems, Inc.

Mizar is a registered trademark of Mizar Digital Systems, Inc. Other names are trademarks of their respective manufacturers.

# Get hopping with T-1 ...

**Our VME-T1 boards will simplify your voice processing,  
video, data and telemetry applications.**

*The 1424 MainStreet® has a single T-1 interface; the 1448 MainStreet has two.*  
Both come with ROM resident software for:

- ISDN
- X.25 LAPB
- Frame Relay
- SMDS
- HDLC
- T-1 framing



## and leave the turtles behind.

**Also available with E-1 interfaces.**

All our boards are VME compliant A24: D16, 6U, single slot.

**Call us at 1-800-267-7231.**



**NEWBRIDGE**  
MICROSYSTEMS

# Technologies move toward hardware/software codesign

Barbara Tuck, Senior Editor

**R**ecent advances in high-level synthesis technology and system verification through re-programmable hardware emulation have pushed in the direction of hardware/software codesign and promise to enhance your ability to bring error-free systems to market.

Architectural-level synthesis got a boost recently when the European Development Center (EDC—Leuven, Belgium) announced that the DSP Station digital signal processing design environment was commercially available. With DSP Station, you can go from one high-level DSP and system specification down to processor assembly code and synthesized custom ICs or ASICs with bit-serial datapath architectures.

In the early phases of design, you can decide on hardware/software partitioning and on the selection of the optimal algorithm for the application. DSP Station distinguishes itself from most synthesis tools by embracing the high-level synthesis tasks of system partitioning and scheduling. It also provides resource allocation, memory management and delay optimization.

## Hooked into Falcon

By using DSP Station, you gain access to more generic design tools through the Falcon Framework from Mentor Graphics (Wilsonville, OR), into which EDC's environment has been integrated. Mentor is an equity partner with EDC, along with Philips International (Eindhoven, The Netherlands) and the Interuniversity Microelectronics Center (IMEC—Leuven, Belgium). Through these ties, EDC has combined the expertise of a leading EDA vendor, a large tool user and a research institute to develop and bring its DSP Station to market. Research results from IMEC and Philips Research have been used in developing DSP Station, and will continue to be used in revising the product. For example, the high-level synthesis capabilities of DSP Station's Mistral I compiler are based on the Cathedral I silicon

compiler of IMEC. All together, IMEC has tuned a total of four silicon compiler environments to specific domains to generate area-efficient chips.

Hugo De Man, vice-president of the VLSI systems and design methodologies division at IMEC, claims that tool

developers will have to make difficult choices as synthesis is extended to higher levels in system building. "Nobody has the recipe for a general high-level synthesis system," he says. "You can't enter general code and get efficient silicon. Within a C++ object-oriented synthesis database, users will have to put tools to work on a high-level data model and a library of knowledge of the particular application being addressed. Synthesizing algorithms and architectures is definitely much more complex than synthesizing gates."

## DSP Station design flow

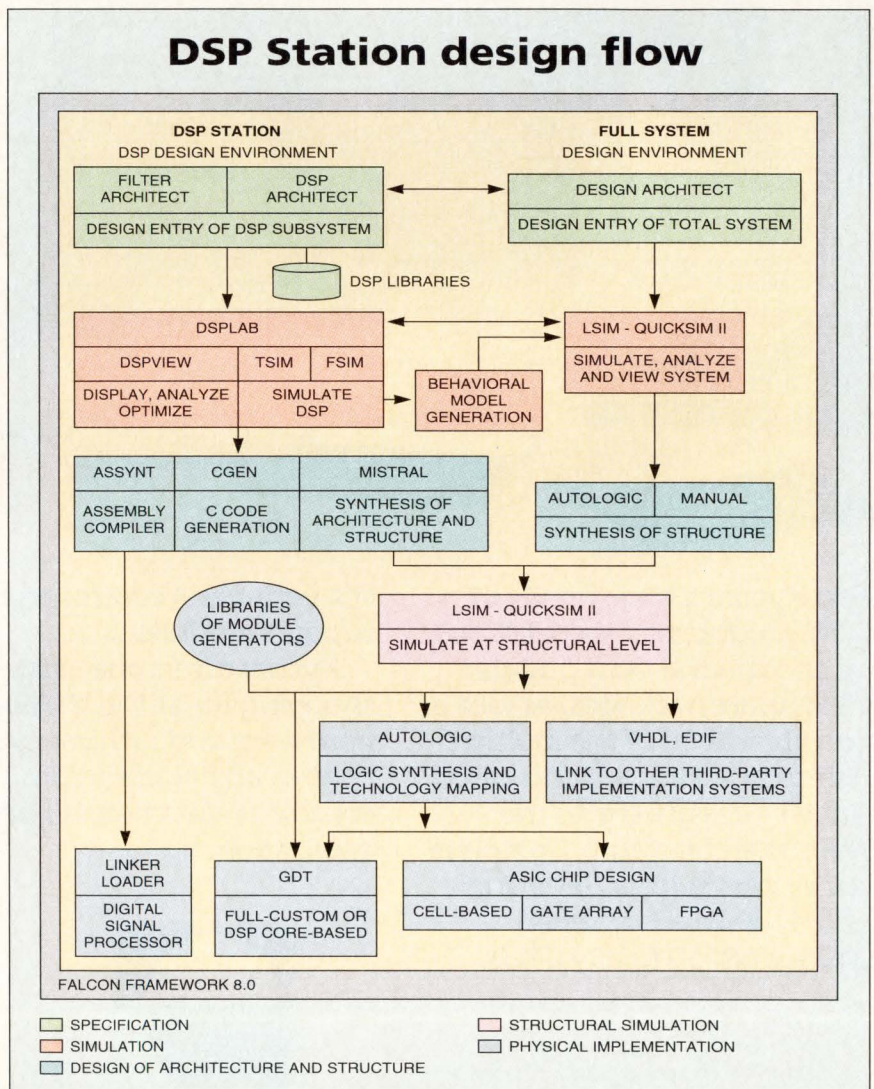

EDC's DSP Station focuses on the DSP portion of a system—but when connected to broader system design tools through the Falcon Framework, it spans the complete analog and digital design environment. The output of its Mistral compiler, at the register-transfer level in VHDL, goes to Mentor's LSim/QuickSim II for structural-level simulation, then to Mentor's AutoLogic for logic synthesis and technology mapping, and finally to either GDT for implementation as full-custom or core-based chips or to Mentor's ASIC design tools for implementation as cell-based chips, gate arrays or FPGAs.

# Run PC Software on a Hardhat Computer

**NEW!**  
XVME-688 80386SX CPU  
\$1350 in OEM Quantities\*

\*100 Units

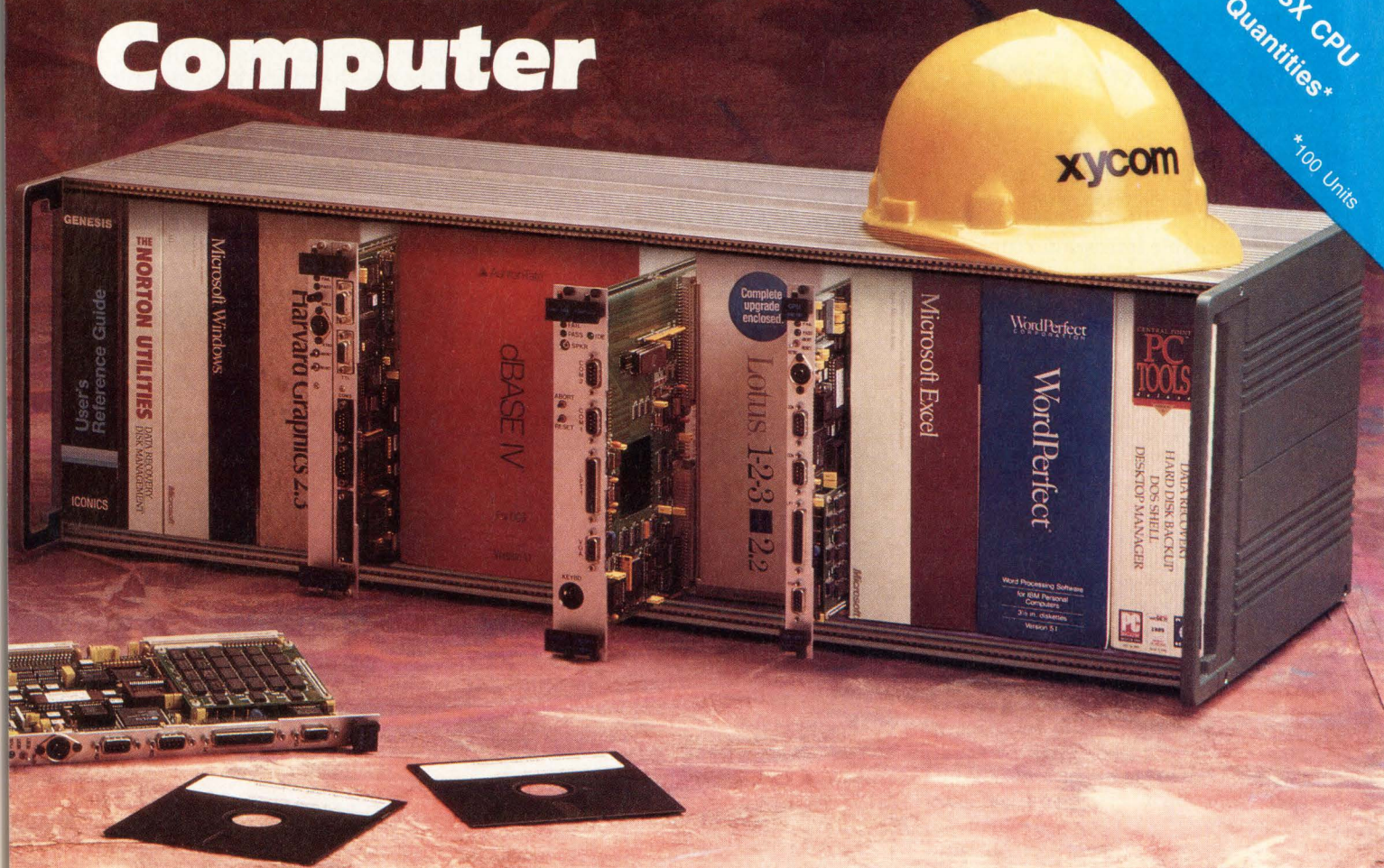

With Xycom's large family of PC/AT products for the VMEbus, you can run the most popular PC software packages, as well as take advantage of the multiprocessing capability and increased reliability designed into the VMEbus architecture. Complete your system with a full line of Xycom hardhat hardened VMEbus 68000 family CPUs,

I/O, peripheral controllers and support modules.

Xycom offers one-stop shopping for all the VMEbus hardware and software you'll need in any automation, control or data acquisition application.



## THE HARDHAT COMPUTERS

750 North Maple Road, Saline, Michigan 48176  
(313) 429-4971 FAX:(313) 429-1010  
In USA call: 1-800-289-9266 (1-800-AT-XYCOM)  
In Canada call: (416) 825-0281  
In Europe call: +44 604 790 767  
In Asia call: (65) 251-0161

**FREE**



Xycom's complete family of PC/AT hardware includes: 80386SX™, 80486SX™ and 80486™ PC/AT processors. Call today for a detailed catalog of all Xycom VMEbus systems.

**1-800-AT XYCOM**

Genesis is a registered trademark of Iconics Corporation. The Norton Utilities is a registered trademark of Symantec Corporation. Microsoft Windows and Microsoft Excel are registered trademarks of Microsoft Corporation. Harvard Graphics® is a registered trademark of Software Publishing Corporation. dBASE and dBASE IV are registered trademarks of Ashton-Tate Corporation. Lotus and 1-2-3 are registered trademarks of Lotus Development Corporation. WordPerfect® is a registered trademark of WordPerfect Corporation. PC Tools is a registered trademark of Central Point Software, Inc. 386 and 486 are trademarks of Intel Corporation.

ASICs & ASIC DESIGN TOOLS

Within the next year, EDC plans to extend DSP Station's synthesis capabilities to bit-parallel micro-coded multiprocessor architectures using Mistral II, which is based on IMEC's Cathedral II silicon compiler and Philips Research's Pyramid system. Mistral II will produce a netlist in terms of a library of module generators targeting standard cells, gate arrays or general cells. The Cathedral III and IV silicon com-

and optimization and into physical implementation.

DSP Station users can enter algorithms through a schematic editor or through textual entry in data flow language (DFL), a commercial version of the Silage flow-graph-based specification language developed at the University of California at Berkeley. For filter design, you can describe the gain and phase characteristics of the filter you need, and

MARS II development system performance

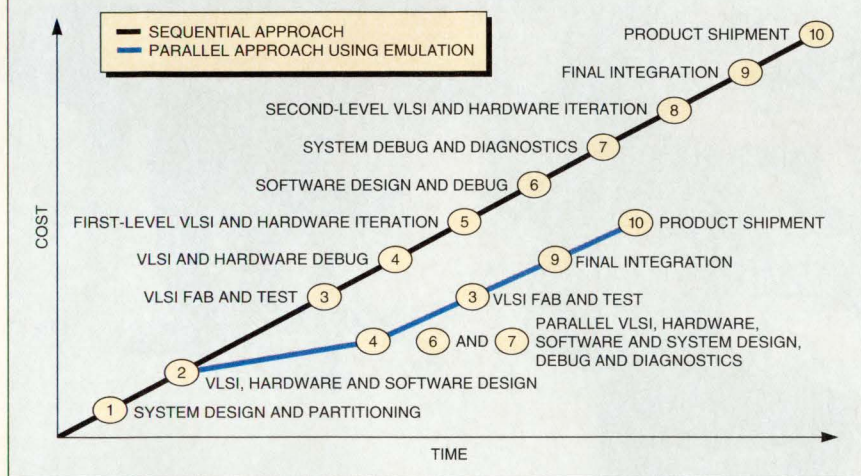

The MARS II system emulators from PiE Design Systems facilitate parallel hardware and software development tasks by enabling emulation of ICs in their end products. In contrast to conventional logic simulation methods, emulation techniques let you exercise complex VLSI components in target hardware systems.

plers target datapath architectures and regular arrays of processors respectively. Though they target different architectural styles, the compilers all accept the same behavioral specification as input.

Though emphasis on hardware efficiency is paramount in all the Cathedral projects, IMEC has built the ability to interactively fine-tune results in critical subparts of the application into the compilers. "We don't guarantee the global optimum," says De Man, "but we do guarantee something that's very difficult to beat by hand."

Since DSP Station has been integrated into Mentor's Falcon Framework, you can have access to Mentor tools at every level of a DSP design—from high-level specification of the algorithm through simulation

DSP Station's Filter Architect will generate an algorithm.

Mentor will distribute DSP Station worldwide. The first signal processors supported by DSP Station are the Texas Instruments TMS320C30 and the Motorola 56000.

Other DSP synthesis solutions

EDC is not the first to take up the challenge of easing system-level DSP design. Comdisco Systems (Foster City, CA) pioneered this area with its Signal Processing WorkSystem (SPW) which today, five years after its introduction, boasts of an installed base of over a thousand. Neither the Comdisco tools nor the Synopsys synthesis tools to which they interface, however, support high-level synthesis tasks. With the

Think serial.

Communicate in your choice of protocols using IndustryPack™ I/O modules. IP-based serial communication gives you more choices in fewer slots for less money.



Choose from 25 IndustryPacks and seven carrier boards to create the single-slot solution that meets your communication requirements.

Pack up to 32 lines in one slot. Whether you need asynch, synch, or T1. Interface RS-232, RS-422, RS-485, non-standard or even optically isolated — IPs support them all.

And single-slot solutions start at under \$48 per line for VMEbus, Nubus and ATbus.

Best of all, 68030-based intelligent carriers give you the highest performance, most versatile communication boards available anywhere.

If you're ready to think serial, put your call to GreenSpring at the head of the queue to receive a free catalog. Or fax us your requirements today.

- IP-Serial
- IP-Octal 232
- IP-Octal 422
- IP-Octal Opto Serial



1204 O'Brien Drive, Menlo Park, CA 94025  
(415)327-1200/FAX(415)327-3808

THE CHOICE WITH A FUTURE

# 68000 Developers Do It FreeForm!



**F**reeForm sets you free! FreeForm is the first remote debugger that gives you the freedom to incorporate *all* the resources and tools of your host machine *directly into your target debugging environment!*

**FreeForm does it right!** Now you can view source with your favorite editor, redirect debugging output into a file, pipe the output to another program, or incorporate your programs *right into FreeForm*. You never have to *exit or escape* from FreeForm in order to compile, link, and re-download your code.

**FreeForm does it real time!** Your application runs in real time because FreeForm is a nonintrusive, monitor-based debugger. And it's not necessary to turn off the code optimizer, because FreeForm debugs fully optimized, production quality C code.

**There's only one thing better than FreeForm--** and that's FreeForm and CrossCode C together! CrossCode C is an advanced optimizing ANSI C compiler package used in over 1,000 applications. It's so good that three out of four clients are referrals from other satisfied users.

**FreeForm gives you power!** Together with your host (UNIX or MS-DOS) and your target, FreeForm and CrossCode C give you the industry's most powerful 68000-series development system!

**FreeForm does it all!** It lets you debug all ROMable 68000-series applications, whether you're designing around the 68000, the 68300 family, the 68040, or the new 68ECXXX.



**Do it FreeForm Today!** Call us at: 1-800-448-7733, EXT. 520 to receive your **FreeForm Demo Kit** for a 30 day free trial. **Do it FreeForm just once--and you'll never go back!**

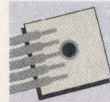

**SOFTWARE  
DEVELOPMENT  
SYSTEMS, INC.**

4248 Belle Aire Lane  
Downers Grove, IL 60515 USA  
Phone: 1-708-971-8170  
FAX: 1-708-971-8513

**The Most Responsive Software Company**

FreeForm (TM), CrossCode (R) and UNIX (R) trademarks



## ASICs &amp; ASIC DESIGN TOOLS

SPW, you have to manually partition your designs into hardware and software by using the DSP Designer block-diagram editor. Nevertheless, you can develop hardware and software in parallel. Comdisco has just begun shipping beta versions of the DSP Framework top-down DSP design environment which supplements the SPW core technology by adding new functions and features, new paths to implementation and new interfaces to standard design tools. The DSP Framework inte-

**We don't guarantee  
the global optimum  
[with Cathedral], but  
we do guarantee  
something that's very  
difficult to beat by  
hand.**

—Hugo De Man, IMEC



grates all of Comdisco's DSP design elements through an intuitive user interface. Production versions will be available by next month, and the toolset will have been integrated into Mentor's Falcon Framework. The DSP Framework supports programmable DSP chips, DSP ASICs, FPGAs, PC-board designs, and DSP core-based designs.

When satisfied with DSP designs created within the DSP Framework, you can call on Comdisco's optional Hardware Design System to convert your optimized bit-accurate block diagram into a VHDL netlist. You can then use this netlist to generate logic gates using Synopsys synthesis tools or other third-party tools. The DSP Framework's VHDL generation capability and full design testbench let you use the toolset for verifying your design all the way down to final layout sign-off, claims senior vice-president Mike Walsh. You can modify designs, test them, and send them back down to the implementation tool to continue the design process.

#### ■ Signal Calculator added

With the introduction of the DSP Framework, Comdisco has added

the Signal Calculator to the SPW's interactive DSP design, simulation and analysis tools. The Signal Calculator applies the look and feel of a hand calculator to the tasks of editing, manipulating and analyzing signals and simulation results. Comdisco packages DSP expertise into its systems applications library as well as its library of over 500 function-level DSP blocks. Last month, Comdisco began shipping an assembly code generator to add to its optional C-code generator and multiprocessor code development option.

Dr. Emil Girczyc, R&D director for high-level synthesis for Synopsys (Mountain View, CA), reports that the company is working on those capabilities. When you go above logic and register-transfer-level (RTL) optimization to domain-specific synthesis, Girczyc agrees with IMEC's De Man that a generic synthesis kernel and specialized tools are required. "A scheduling algorithm might be successful for only a very narrow application area," he says.

And how does DSP Station compare to the VHDL-based Frenchip synthesis tool from Dassault Electronique (Saint-Cloud, France), which can synthesize ASICs with DSP function blocks? "The synthesis in DSP Station starts one level above that in Frenchip," says EDC's general manager, Herman Beke. "We first synthesize an optimal architecture to implement an algorithm and then continue, like Frenchip or other VHDL synthesis packages, with the synthesis of a structural implementation of that architecture. One of the intermediate results of DSP Station is RTL, which could be fed into Frenchip as an alternative to our own structural synthesis." Frenchip has recently been integrated into the MultiSim Architect VHDL toolset from Teradyne EDA (Boston, MA).

Dr. Lev Markov, director of optimization at Racal-Redac (Mahwah, NJ), reports that his company has developed the prototype of a generic performance-driven architectural synthesis tool that would sit on top of RTL tools such as Racal-Redac's SilcSyn or Synopsys; the tool lets you explore domain-specific architectures under your control. From a single behavioral description, you

# Think parallel.

**Digital I/O IndustryPacks™ give you more ways to connect more lines in less space for less money.** Up to 192 parallel lines fit in one VME or ATbus slot – up to 96 lines in a Nubus slot.

Whether you need optical isolation, high voltage/high current drive, interrupts on every input or simply lots of reliable, inexpensive I/Os, chances are that one of our six convenient digital IndustryPacks will meet your requirements.

All IPs work in all slots, so you can easily create the interface solution you need from over thirty IndustryPacks and IP carrier boards.

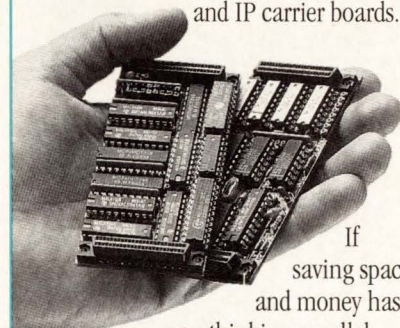

If saving space and money has you thinking parallel, call or fax GreenSpring Computers for a free catalog today.

- IP-Digital 24
- IP-Digital 48
- IP-Dual PI/T
- IP-ADIO
- IP-Opto Interrupter
- IP-Opto Driver

**GREEN SPRING**  
COMPUTERS

1204 O'Brien Drive, Menlo Park, CA 94025  
(415)327-1200/FAX(415)327-3808

**THE CHOICE WITH A FUTURE**

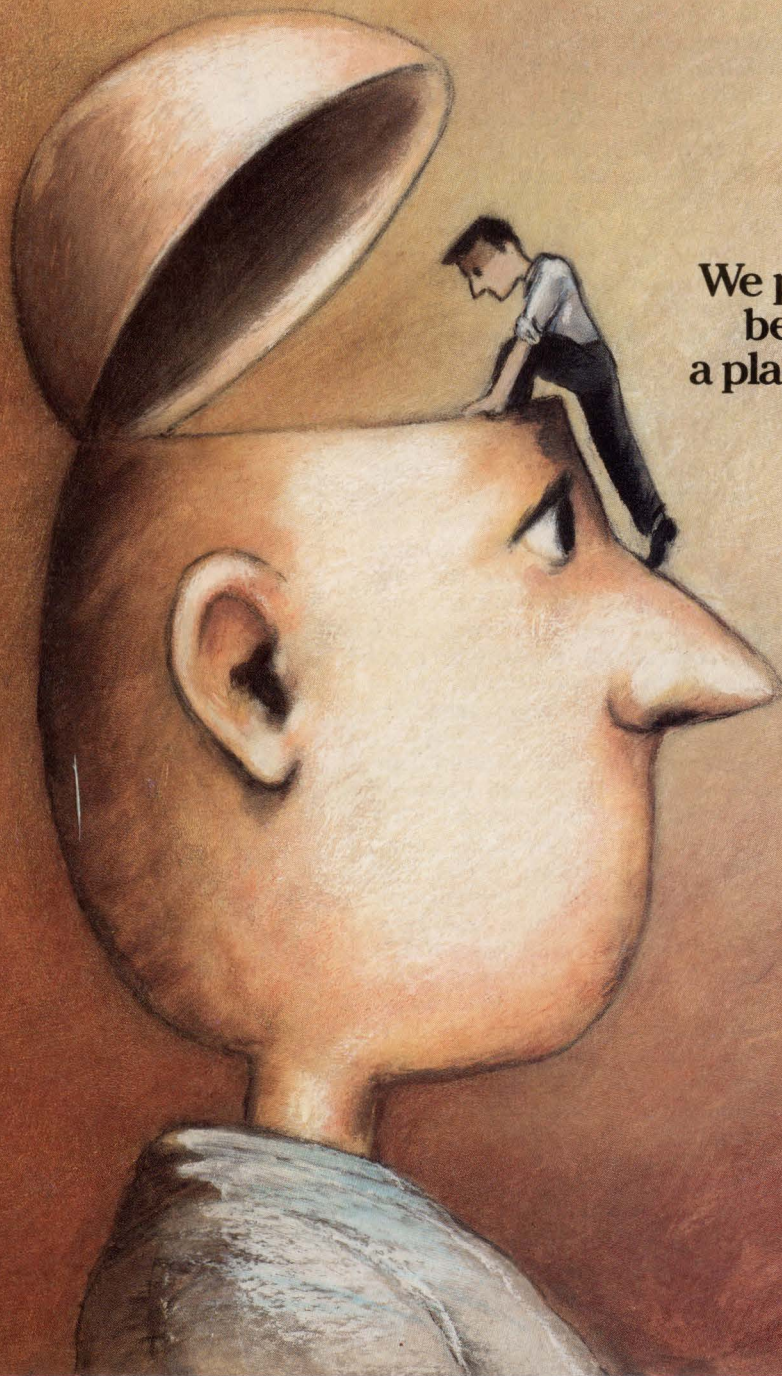

We provide more solutions  
because we've been to  
a place few companies have  
dared to venture.

When it comes to embedded systems design, nobody offers better solutions than FORCE.

But, we have to admit, we had a little help. From you.

At FORCE, we get inside the heads of our customers to learn about their requirements.

The result is the world's most advanced CISC and SPARC-based VME single board computers. And bus extensions—like SBus and our own FLXibus™.

When you need to design the next generation, you can count on FORCE for the best in

VME64/Plus™ or Futurebus/Plus™. Because better products come from better knowledge.

For a partner that can get you up and running fast, call 800-237-8863, ext. 10. In Europe, call 49.89.608-14-0. And thanks for keeping an open mind.



3165 Winchester Blvd., Campbell, CA 95008-6557  
Prof. Messerschmitt-Str. 1, W-8014 Neubiberg München



ASICs & ASIC DESIGN TOOLS

would create application-specific RTL structures and would interactively deal with performance, area, timing constraints, and required and prohibited resource sharing, so that the RTL netlist would satisfy all design requirements. You would have to partition a system design into hardware and software components, however, before picking up the architectural synthesis tool.

**System-level verification**

A second technology directed at system-level design is that of reprogrammable hardware emulation,

**One of the intermediate results of DSP Station is RTL, which could be fed into Frenchip as an alternative to our own structural synthesis.**

—Herman Beke, EDC



which validates VLSI designs in the final product. Since its introduction in 1989, the RPM Emulation System of Quickturn Systems (Mountain View, CA) has been without head-on competition. But PiE Design Systems (Sunnyvale, CA) has now introduced its MARS II series of system emulation products. (MARS is an acronym for modular, automatic, retargetable, and scalable.)

MARS II is based on Xilinx 4000 FPGAs and is claimed to operate at speeds up to 8 MHz. You can use it to verify the system-level operation of microprocessors, complex function-specific ICs and ASICs. MARS II includes timing-driven partitioning software, resulting in a system that can reduce time to emulation from weeks to hours. A specialized algorithm automatically partitions a design and maps it to the logic emulation hardware—all in a single pass.

Debugging and emulation functions are separate in the MARS II series, with the Ethernet-based de-

bugger being a shared resource supporting several emulation modules. Both debugger and emulator can be expanded in increments. Also, future emulation modules based on newer FPGA technologies will be able to coexist with older modules used on the same project.

Just weeks after PiE Design Systems brought its system emulator to market, pioneer Quickturn enhanced its own Xilinx-based reprogrammable hardware emulator, making it a moving target for its new competitor. The newly introduced 50,000-gate RPMplus, for systems using ASICs or full-custom chips, brings the emulation of nonsynchronous and asynchronous design styles to Quickturn customers for the first time. A pair of new algorithms analyzes complex designs and maps them into a representation guaranteed to be free of any timing violation. These algorithms map all synchronous and nonsynchronous designs without user intervention. For asynchronous portions of the design, the algorithms allow precise control of emulation timing. RPMplus offers full X Windows support, automatic transfer of data between CAE and emulation environments and integration into the Verilog and Mentor Graphics simulation environments. ■

*For more information about the technologies, products or companies mentioned in this article, call or circle the appropriate number on the Reader Inquiry Card.*

Comdisco Systems (415) 574-5800 .....	Circle 245
Dassault Electronique 33-1-34-81-71-29 .....	Circle 246
European Development Center 32-16-20-30-63 .....	Circle 247
Mentor Graphics (503) 685-7000 .....	Circle 248
PiE Design Systems (408) 738-8899 .....	Circle 249
Quickturn Systems (415) 967-3300 .....	Circle 250
Racal-Redac (201) 848-8000 .....	Circle 251
Synopsys (415) 962-5000 .....	Circle 252
Teradyne EDA (800) 777-2432 .....	Circle 253

# Think nonlinear?

**Nonlinear thinking helps solve problems, but...** if your requirements include data acquisition or signal processing, you need one of our highly linear A/D or D/A converters.

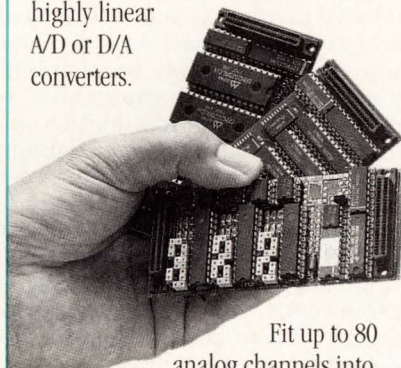

Fit up to 80 analog channels into one VMEbus or ATbus slot – up to 40 per Nubus slot. Directly connect most sensors including thermocouples and current loops. Programmable gain and low drift guarantee precision data.

If you need 16-bit DACs or 16 separate DACs, choose from five precision ADC and DAC IndustryPacks™ to build your analog subsystem in less space with less heat, drift, software or expense than alternative solutions.

If you're ready for linear solutions to your data acquisition or signal processing needs, call or fax us your requirements today. Think efficiency... think GreenSpring!

- IP-ADC
- IP-DAC
- IP-ADIO
- IP-DenseDAC
- IP-16DAC



1204 O'Brien Drive, Menlo Park, CA 94025  
(415)327-1200/FAX(415)327-3808

## Tools wed Ada compilers to integrated development environments

Tom Williams, Senior Editor

Vendors of software development tools find themselves in a sea of possibilities in terms of what to offer and support and what to leave to other vendors. This is an industry where partnerships blossom—in bundling, say, another company's compiler with your toolset, or in working out compatibilities and interfaces so that your programming toolset (for example, an editor, compiler, library, and debugger) can be used with another company's higher-end CASE tools. But the promise of comprehensive, all-encompassing frameworks where any tool can be plugged in and used with any other has yet to become reality.

### Two paths for Ada

Building efficient Ada compilers, for example, has apparently become such a specialized task that vendors of development tools and environments are quite content to either adapt and bundle compilers from third parties or build in hooks that let you integrate your choice of compilers into your environment. Rational (Santa Clara, CA) is an example of a company that's announced a new tool that lets you integrate your choice of Ada compilers into its extensive software engineering environment. On the other hand, SunPro, a division of Sun Microsystems (Mountain View, CA), has purchased a very efficient Sparc compiler from Verdex (Herdon, VA) and has established hooks so that users of its Sparcstation-based Ada development environment can cross-compile, edit and debug code for target systems using other processor-specific compilers from Verdex without leaving the Sun Ada development environment.

Sun's Ada development environment consists of the Sun Ada compiler for the Sparc and a set of tools called Sparcworks/Ada. Sparcworks/Ada supports the edit/compile/debug cycle, but it also includes an Ada source-code generator for a drag-and-drop graphical interface builder named Devguide. Sparc-

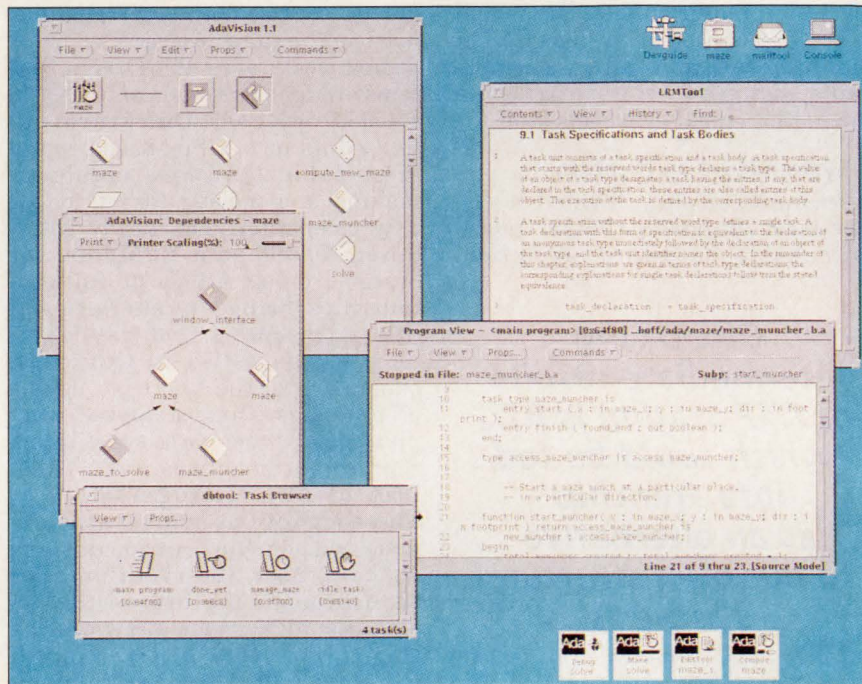

The Sun Ada development environment, via the AdaVision graphical interface, lets you use a single toolset, such as the library management, debugger, editor, and help facilities shown here, to develop software for Sparc workstations, as well as a number of embedded target systems.

works/Ada consists of AdaVision, an OpenLook-based graphical tool for managing the Ada library unit structure and dependencies; a window-based debugger called dbtool; an editor named EditTool that synchronizes compiler errors with source code; and an on-line reference manual, LRMTool.

The Rational Environment, by contrast, encompasses a wider range of tools but also stops short of supplying its own compilers. Like Sun, it's also establishing partnerships with CASE vendors such as Cadre Technologies (Providence, RI). The Rational Environment incorporates support for the edit/compile/debug cycle, configuration management and version control (CMVC), and a repository that manages details about the program such as requirements, design, and information about system builds and releases from the CMVC facility.

Both companies have an interest

in supporting as many processors and as many compilers as possible so that, according to SunPro product manager David Spenhoff, "A user on a Sparcstation only has to learn one interface to develop software to run on the Sparcstation, and can also use that same interface to create embedded software for different target systems." Sun has added cross-compiler support for a number of the VADScross compilers produced by Verdex. They include VADScross 6.0.5 for the Motorola 680X0 family, as well as VADScross for the Sparc and the MIPS 3000. Using these compilers, you can edit, compile and debug code with the Sparcworks/Ada tools directly over a network from your Sparcstation.

### The Rational approach

Rational's approach has been to supply a tool that lets you immediately use a number of compilers that have been adapted by the company, and



# Learner's Permit.

FOR JUST \$50, MOTOROLA'S NEW 68HC705KICS KIT CAN PUT YOU ON THE ROAD TO AN ECONOMICAL 8-BIT DESIGN.

Learning to design Motorola's low-cost, 68HC05 K-Series microcontroller into your application is fast – and easy – with the new 68HC05 K-Series In-Circuit Simulator Kit.

By combining software simulation with an innovative hardware interface, the 68HC705KICS gives you real hardware emulation at simulator speeds – to put you in the driver's seat from the word go.

It helps you learn everything you need to know about using the 16-pin 68HC05 K-series, Motorola's newest addition to the world's most popular 8-bit microcontroller family. These low-pin count microcontrollers are ideally suited for cost-sensitive applications requiring 8-bit performance at 4-bit prices.

**THIS SPECIAL OFFER COULD PUT YOU BEHIND THE WHEEL OF A NEW FORD EXPLORER.**

Just order the 68HC705KICS kit, take it for a test drive, and enter your 68HC705KICS application in our design contest.

We'll judge designs based on creative and efficient use of the 68HC705K1 features, like the on-chip personality EPROM, and cost savings realized from reduced component count.\*

The winner gets to drive off in a top-of-the-line 1992 Ford Explorer.

**FULLY LOADED: \$500 WORTH OF DEVELOPMENT TOOLS AND ACCESSORIES FOR ONLY \$50!**

Order your 68HC705KICS kit during this special offer, and you'll get a great package deal that includes:

- In-circuit source level simulator/programmer board with target cable
- Screen-oriented editor/assembler/debugger/simulator software from P&E Microcomputer Systems
- 68HC705K1 windowed EPROM-version microcontroller
- Technical literature, including a handy introductory guide to understanding and using small microcontrollers.

**HURRY, YOUR LEARNER'S PERMIT EXPIRES JUNE 30.**

The low \$50 sticker price on the 68HC05 K-Series In-Circuit Simulator Kit is good only through participating Motorola distributors! But you better act now. This special offer ends June 30, 1992. And at \$50, the 68HC705KICS kit is priced to move.



**MOTOROLA**

\* Official information on rules, regulations and contest deadlines is included with each 68HC705KICS kit. Government employees and Motorola employees and their families are not eligible for the 68HC705KICS contest. If the winner is not permitted to accept this prize by his or her employer's policies or practices, Motorola will donate an equivalent cash amount to an appropriate charity designated by the winner. Void where prohibited or restricted by law. (M) and Motorola are registered trademarks of Motorola, Inc. © 1992 Motorola, Inc.

SOFTWARE & DEVELOPMENT TOOLS

**Integrated development process**

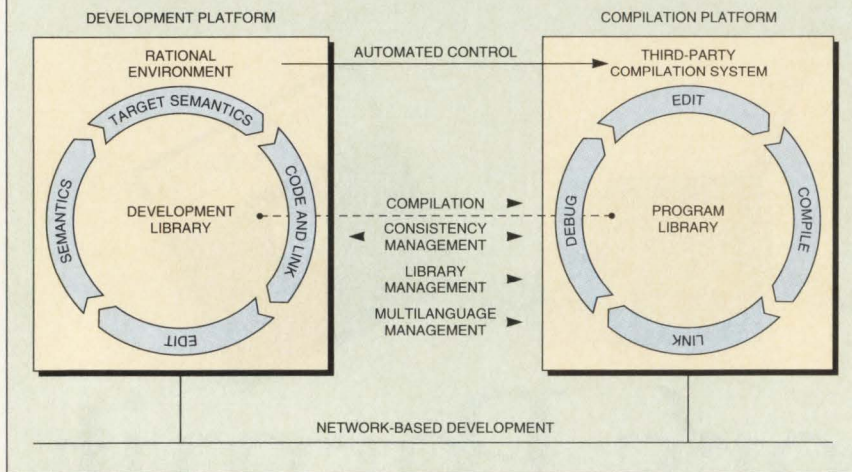

Rational's *Compilation Integrator* lets you access a variety of third-party compilation systems, including libraries and linking facilities, from a single, integrated software engineering environment which includes third-party development tools as well as Rational's own development and configuration-management tools.

then adapt additional compilers of your choice. Rational *Compilation Integrator* then lets programmers have their choice of a wide variety of high-quality Ada compilers on the market. "It's quite common for large projects to have multiple compilers," says Gerard Rudisin, director of marketing for Rational. "In the space station project, there are four compilers in use."

The advantage of the *Compilation Integrator* is that Ada programs for different machines can be developed, tested and managed within a single software engineering environment, but Rational doesn't have to develop cross-compilers itself for use with its system.

Rational's *CMVC* facility extends via the *Compilation Integrator* to remote platforms. Through it you can directly execute target compiler tools to initialize a target library, manage its units and compile source code. The *Compilation Integrator*

# Mixing REAL TIME With REAL UNIX<sup>®</sup> Is Not Magic... It Is Technology.

VenturCom's VENIX™ family of operating systems is the only realtime USL UNIX System V for Intel based platforms. Not a clone. Not just a realtime executive on top of UNIX.

Real UNIX provides designers with SVID and POSIX standards, access to NFS, X-Windows, Motif, streams, complete development tools and DOS tasks under UNIX. Plus, close tracking of future technologies.

Realtime adds performance and functionality to UNIX O/S with full kernel preemption, priority scheduling, contiguous file system, average interrupt latency of 50 μs, bounded context switches, memory locking, asynchronous I/O and much more.

VENIX and Embedded-VENIX products are used by Rockwell, Toshiba, General Electric, Honeywell and other leading edge companies. Ask us for our free Realtime UNIX/ VENIX Technical Overview.



**Real Time/Real Unix**  
215 First Street, Cambridge, MA 02142 (617) 661-1230

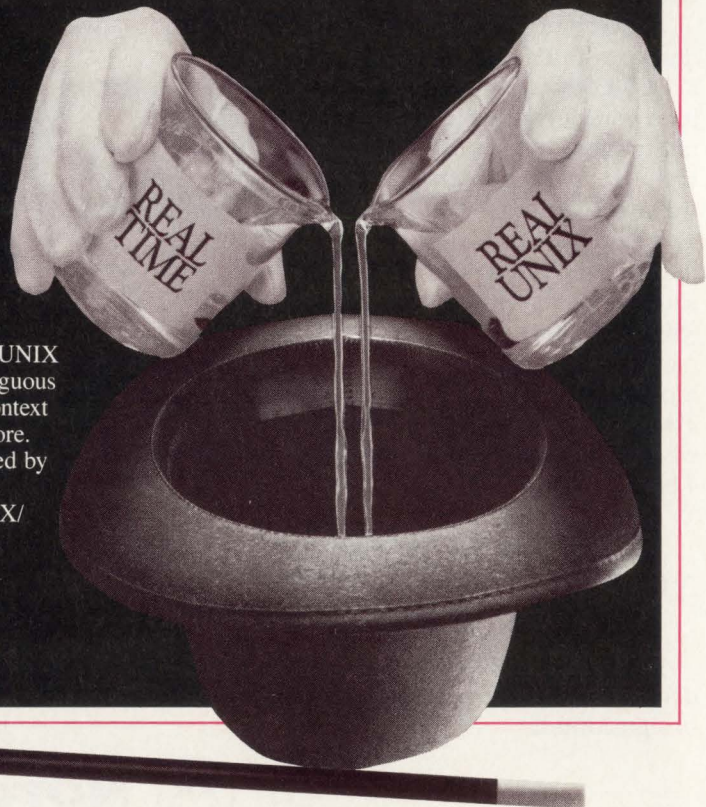

CIRCLE NO. 30

# NOTICE

WE'VE BEEN ASKED TO MAKE IT VERY CLEAR THAT  
THERE'S A WHALE OF A DIFFERENCE BETWEEN QNX® AND UNIX®.

## WE'RE GLAD TO OBLIGE.

EVEN THOUGH THE QNX REALTIME OPERATING SYSTEM IS NOT BASED ON UNIX SOURCE CODE, WE CAN UNDERSTAND HOW SOME DEVELOPERS MIGHT CONFUSE THE TWO. AFTER ALL, QNX FOLLOWS THE LATEST IEEE POSIX 1003.1 AND 1003.2 OPEN SYSTEMS STANDARDS, SO YOU GET THE SAME API AND UTILITY SET FOUND IN MANY UNIX SYSTEMS.

BUT LOOK BENEATH THE SURFACE AND YOU'LL SEE TWO FUNDAMENTALLY DISTINCT ARCHITECTURES. A MONOLITHIC OS ON THE ONE HAND, A MICROKERNEL OS ON THE OTHER. THEY'RE DIFFERENT SPECIES ALTOGETHER, AS DIFFERENT AS A WHALE AND A SCHOOL OF DOLPHINS.

ARCHITECTURE YOU CAN BUILD ON  
QNX'S MODULAR, MICROKERNEL ARCHITECTURE GIVES YOU REMARKABLE FLEXIBILITY. OS SERVICES ARE PROVIDED BY A TEAM OF COOPERATING PROCESSES RATHER THAN BY A MASSIVE MONOLITHIC KERNEL. THE RESULT? YOU CAN STRIP QNX DOWN TO A ROM-ABLE EMBEDDED SYSTEM. OR BUILD IT UP TO A VAST NETWORK AND HARNESS THE POWER OF HUNDREDS OF CPUS.

OUR PRICING IS MODULAR TOO, SO YOU'RE NOT FORCED TO PAY FOR WHAT YOU DON'T NEED.

### REALTIME PERFORMANCE

#### YOU CAN COUNT ON

NEED THE SPEED OF A FAST, REALTIME EXECUTIVE? QNX CLOCKS IN AT 16  $\mu$ SEC PER CONTEXT SWITCH ON A 33 MHZ 80486.

BUT QNX DOESN'T STOP THERE. WITH ITS PRIORITY-DRIVEN, PREEMPTIVE SCHEDULING, YOU CAN BUILD REAL REALTIME SOLUTIONS.

### DISTRIBUTED PROCESSING

#### YOU CAN BET ON

QNX CAN TRANSFORM A BUNCH OF ISOLATED MACHINES INTO A SEAMLESS SUPERCOMPUTER,



REALTIME OPERATING SYSTEM

CIRCLE NO. 32

ORCHESTRATING HUNDREDS OF CPUS WITH ITS NETWORK-WIDE IPC. YOU'RE IN COMPLETE CONTROL OF ALL RESOURCES AT ANY POINT, FROM THE PLANT FLOOR RIGHT UP TO YOUR DESKTOP.

### SUPPORT YOU CAN DEPEND ON

DURING THE LAST TEN YEARS, WE'VE EARNED A REPUTATION FOR OUTSTANDING TECHNICAL SUPPORT. WE OFFER EVERYTHING FROM 24-HOUR ONLINE CONFERENCING TO ONSITE CONSULTING, SO YOU CAN EASILY REACH THE PEOPLE WHO MAKE UP THE QNX DEVELOPMENT TEAM. THEIR EXPERTISE CAN HELP YOU KEEP YOUR DEVELOPMENT PROJECTS RIGHT ON COURSE.

TO FIND OUT HOW YOUR APPLICATIONS CAN THRIVE IN THE QNX ENVIRONMENT, CALL 1-800-363-9001, (EXT. 103).

QUANTUM SOFTWARE SYSTEMS LTD.  
175 TERENCE MATTHEWS CRESCENT  
KANATA, ONTARIO, CANADA

K2M 1W8

TEL: 613-591-0931

FAX: 613-591-3579

# ARCHITECTURE MAKES THE DIFFERENCE

SOFTWARE & DEVELOPMENT TOOLS

maintains state and history information in the Rational Environment for each unit in a remote program library, letting you check for consistency and incorporate changes that are made back into the software engineering environment's control after they are recompiled.

While the Ada language is standard, individual compilers differ in terms of the nuts-and-bolts characteristics of the processors they support, optimization features, data layout, and other attributes. Rational found a way to configure its environment to take the nitty-gritty

differences among compilers into account. The Rational Environment then serves as a universal host, supporting all of the program development and much of the testing. Final compilation can be done with a native compiler on the target system, or with a cross-compiler that has been adapted to the Compilation Integrator on the host system.

**Differences accommodated**

The kinds of differences that are accommodated by the Compilation Integrator are such things as the length of words, floating-point representation and whether a machine automatically rounds numbers or not. The different "pragmas," or instructions to the compiler that tell it which optimization modes to turn on and off—determining the length of arrays, for example—have to be defined for each compiler. All of this detail is fairly easy to do, taking about a week according to Rudisin, and it's something that customers can do as well. Rational currently provides several 'shrink-wrapped' integrations of popular compilers. These include the AIX Ada/6000 from IBM, the SunOS Sparc Ada, the LYNX i386 and Unix i486 Ada compilers from Alsys, the DEC VMS VAX compiler, and the VMS i960 compiler from Tartan.

The Rational Environment is required to use the Compilation Integrator. The Environment, which sells for \$25,000 per user, also lets third-party tools such as the Teamwork CASE toolset from Cadre be incorporated, along with Rational's own Design Facility front-end tool. The Compilation Integrator sells for \$2,000 per user. The Sun Ada development environment ranges from \$10,000 for a single network license to, for example, \$7,480 for a 25-seat license package. ■

*For more information about the technologies, products or companies mentioned in this article, call or circle the appropriate number on the Reader Inquiry Card.*

- Cadre Technologies**  
(401) 351-5950 ..... **Circle 229**
- Rational**  
(408) 496-3600 ..... **Circle 230**
- Sun Microsystems**  
(415) 960-1300 ..... **Circle 231**
- SunPro**  
(800) 926-6220 ..... **Circle 232**
- Verdix**  
(703) 318-5800 ..... **Circle 233**

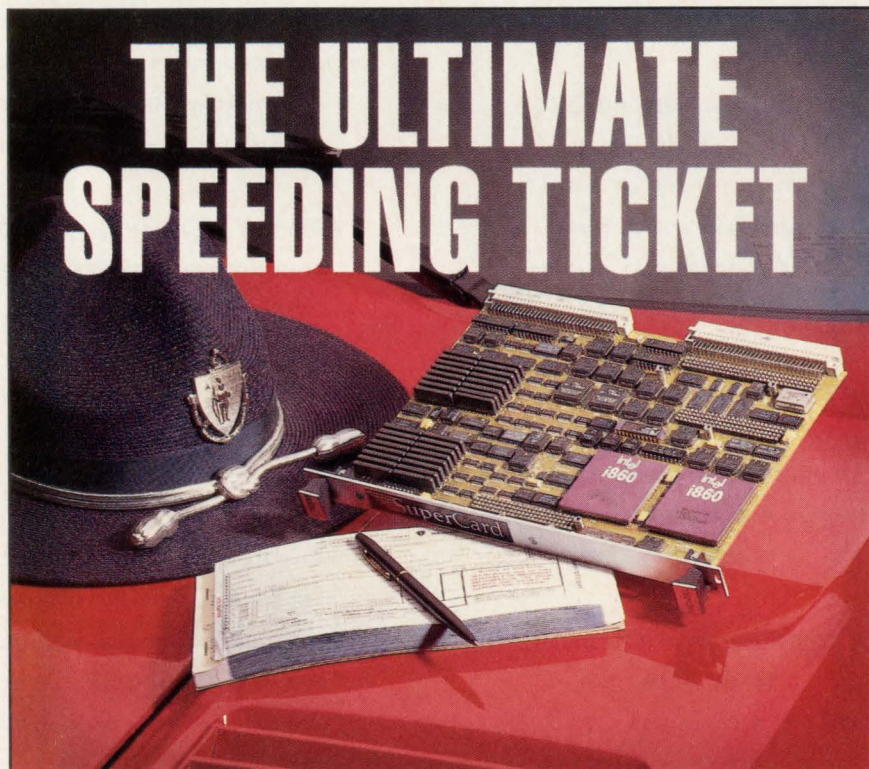

## SuperKit: When Development Time is as Critical as Compute Time

SuperCard i860-based vector processors are superfast, more than 2.5 GigaFLOPS of raw multiprocessor power, but then you'd expect that. The real news is SuperKit, a robust software toolkit which cuts development time to the bone and gets you up and running superfast.

Fortran, C and ADA compilers... the industry's largest scientific subroutine libraries... diagnostics aplenty... a pSOS+ real-time kernel running in a UNIX-like environment... CASE tools... and much more.

And talk about versatility... from 6U VME boards to fully packaged multiprocessor systems to MIL spec units... large memories... peripheral I/O mezzanine boards... SuperCard has it all.

Find out how you can benefit from SuperCard and SuperKit solutions just right for you. Call or write CSPI, 40 Linnell Circle, Billerica, MA 01821.

1-800-325-3110. Or 617-272-6020. Fax: 508-663-0150.





# Optimize your 680x0 Application to its peak

...with Oasys Embedded/Cross Software Tools.

## Reach the pinnacle of your development with Oasys Cross Tools

Oasys delivers full 680x0 Cross and Native development tool kits built around the industry standard Green Hills compilers.

The Green Hills 680x0 compiler's Dhrystone rating is 35% faster than Sun's native C compiler. Using the new procedural inlining optimization, the rating jumps to a staggering 80% improvement.

## Advanced C, C++, FORTRAN and Pascal Language Support

- Full ANSI C XJ311 support with switch selectable K&R C support.
- A true C++ Compiler for cross development.
- FORTRAN 77 with VAX VMS and DoD MILSTD-1753 extensions.
- Pascal ISO Level 1 support.
- All compilers are inter-language callable.
- Native compilers are supported for 680x0, 88000, 386™ & i860™ microprocessor hosts.

## Available Now!

Oasys tools are available on over 35 UNIX based workstations and systems including DEC (VMS/Ultrix), Sun, HP/Apollo, IBM (OS/2 and AIX), and DG. Call us for the complete list.

## Other Cross Tool Kits include:

88000, 80386, i860 and Microsoft C.

## Integrated 680x0 Cross Development Tool Kits

### Green Hills 68000/10/20/30/40 Optimizing Cross Compilers (C, C++, Pascal, FORTRAN)

- Superior register allocation, inlining and loop unrolling techniques.
- Support for position independent code and data.
- 68881, 68882, 68332 support.
- ANSI C run-time source library included for cross development.

### Oasys UDB Universal Debugger

- Source level remote debugger for embedded programming.
- Multi-targeted and multi-window (supports 680x0 and 88000 targets).
- Extensive macro language.
- Customize communications to your target.

### Oasys 680x0 Assembler/Linker

- Macro Assembler, Linker, Librarian, Cross Reference and Symbol File Format Utilities.

### Oasys 680x0 Simulator

- Invaluable for debugging software without target hardware.

Call Now for a FREE  
MULTI Debugger Demo Disk!

(for SUN-4 SPARC only)

(617) 862-2002

# Oasys

One Cranberry Hill, Lexington, MA 02173  
Single Source, Total Solutions

Trademarks acknowledged to AT&T, CaseTools Inc., Data General, Digital Equipment Corporation, Green Hills Software, Inc., HP/Apollo, IBM, Motorola Inc., Microsoft Corp., Sun Microsystems, and XEL, Inc.  
386 and i860 are trademarks of Intel Corp.

Worldwide Support: **Australia**—Forefront Computing Svcs 03-785-1122  
**Benelux**—Computing & Systems Consultant 040-434-957 **France**—RTS  
01-6986-1958 **Germany**—Stollman 040-890-880 **Israel**—Ankor Computers Ltd.  
972-3-5483737 **Italy**—Instrumatic 02-353-8041 **Japan**—ERIC 03-668-8866, MCM  
03-487-8477 **Norway**—OTE Komponent 02-30-6600 **Singapore**—Automated  
Systems Ltd 02-789-9566 **Spain**—Decisa 01-204-4500 **Sweden**—Traco AB  
0893-0000 **Switzerland**—Zuhke Engineering AG 01-730-7055 **UK**—Real Time  
Products 021-236-8070

## VMEbus SSBLT spec now on target

Warren Andrews, Senior Editor

The proposed source-synchronous block transfer (SSBLT) addition to the VMEbus Revision D specification has had some rough sledding over the past several months, but it looks like clear sailing from here on. Making the approach viable, however, has called for some sweeping but much needed upgrades to the original VME specification.

The proposed SSBLT addition to the specification, which calls for the elimination of VMEbus handshake signals and lets the data lines provide the clock signal for transferring information, was initially looked upon favorably by most of the technical committee members of VITA (VME International Trade Association). But SSBLT subsequently came under attack as the proposed addition to the specification was more closely scrutinized. Criticism focused on two areas. First, the proposal called for using the rising edge of the signal, as opposed to the falling edge, which is used exclusively in the VMEbus 1014 specification. Second, because SSBLT is a source-synchronized protocol and doesn't use a handshake signal, timing parameters must nominally be set using a "worst-case" approach.

Some VITA members feared that rushing into a new specification before it's well tested could be an embarrassing mistake. "We certainly don't want to approve some specification that won't work, or won't be compatible with existing equipment," says Wayne Fischer, SSBLT proponent and director of strategic marketing for Force Computers (Los Gatos, CA).

### Handling the worst case

The main criticism of the SSBLT proposal came from Dieter Nattkemper, former product manager for Openbus products for Newbridge Microsystems (Kanata, Ontario). "The 160-Mbyte/s transfer rate currently defined for the SSBLT protocol can't be achieved over VMEbus," he says. "The protocol takes an open-loop approach and, as such, doesn't have any handshake to guarantee successful completion of the cycles. The SSBLT protocol must guarantee

reliable operation for the worst-case scenario; in effect, this would limit its performance to about 86 Mbytes/s, according to my model. The only way to reliably realize the promoted rate of 160 Mbytes/s would be to either redesign the physical interface of the VMEbus or limit the number of slots," Nattkemper concludes.

Performance Technologies (Rochester, NY), too, has done some preliminary analysis which tends to confirm the worst-case study done by Nattkemper. In addition, others have reviewed Nattkemper's model and find it accurate. Richard DeBock, leading engineer at Matrix

(Raleigh, NC) and one of the original researchers of the VME specification, has looked at Nattkemper's figures and comments, "they [the timing figures] look a lot like mine"—referring to his initial timing definition of VMEbus.

Early in the debate Fischer was optimistic. "I feel totally confident that SSBLT will provide a tremendous advantage to VME, although I believe it will be necessary to do some heavy analysis and test," he said. He believed it might be necessary to adjust the mechanism somewhat, especially since the rising and falling edges of VMEbus signals are not, as defined, symmetrical. But

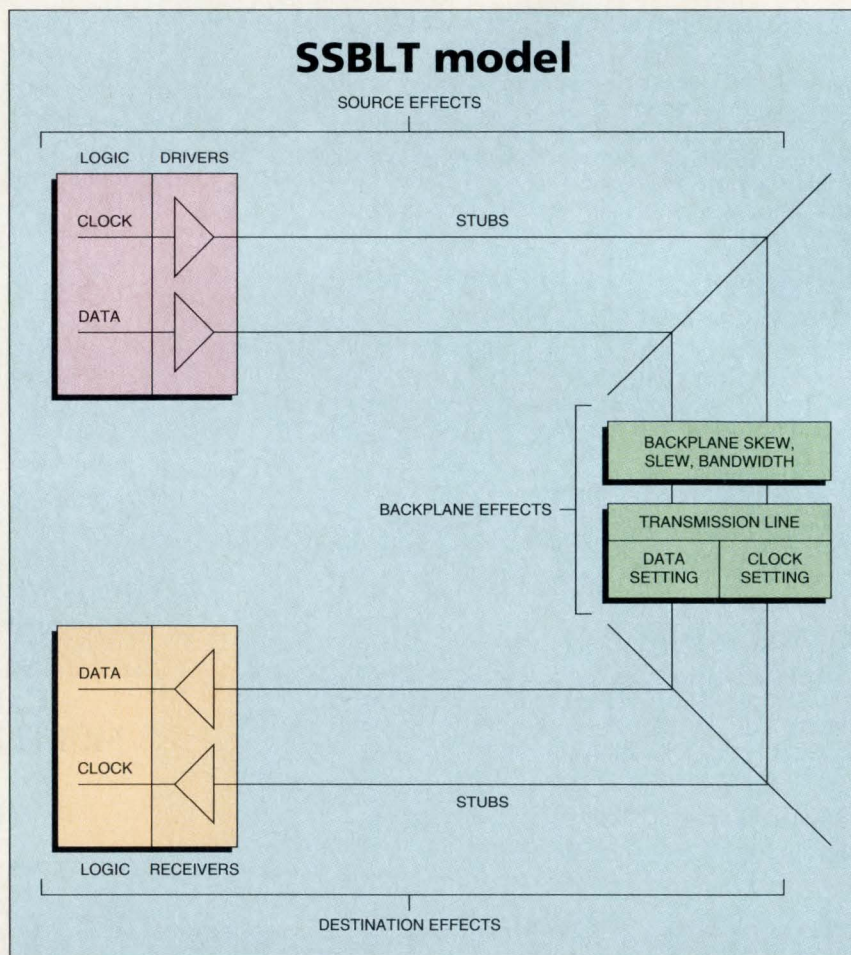

According to Newbridge Microsystems, the SSBLT model produces a number of delays, including source effects, backplane effects and destination effects. When considered in a worst case, these effects result in a significant slowing of the SSBLT protocol if reliability is to be maintained.

**FLUKE®**



**PHILIPS**

# Test results:



90% of those who try  
a Philips Logic Analyzer from Fluke buy one.



100% get a free DMM\*.

Our logic analyzers sell themselves. All we have to do is get one in your hands. To make sure you do, we're giving you a Fluke DMM\*, whether you buy our analyzer or the competition's. (See attached card for complete details).

Only the Philips PM 3580 family of logic analyzers give you *true* dual state and timing on up to 96 channels - simultaneously. All accessible with one probe and one keystroke. Which means no more dual probing or reconfiguration between state and timing. Or no probes at all if you use our boundary-scan test option!

\*The top-of-the-line Fluke 12 in our newest DMM family. It combines a smart set of troubleshooting features in a new design that's exceptionally fast and simple to operate — with one hand. It's yours after our 30 minute demo, no matter whose logic analyzer you purchase.

All our analyzers feature 50 MHz state and up to 200 MHz timing speeds. As well as integrated state and timing triggering for fast debug of complex hardware and software problems. Plus broad  $\mu$ p support like Intel®'s i486; i386; 80286; 80186/88 families. The MCS-96, 8051, and i960 families. And the Motorola 68040 to 6800, 68HC11, 68332/1, 68302, 68340, 56001, AMD®'s AM 29030, and TI's 320Cxx family.

The PM 3580 family of logic analyzers is priced from \$4495 to \$11,450 - about half the cost of comparable analyzers. What's more you can have them up and running in only 30 minutes.

Find out why the PM 3580 family of logic analyzers were the only ones cited for

excellence and innovation by *Electronic Design*, *EDN*, *Embedded Systems*, *Electronic Products*, and *R&D* magazines. Take the Fluke Challenge. The odds are 100% you'll be totally impressed.

For literature, our video or a demonstration, call **1-800-44-FLUKE**.

John Fluke Mfg. Co., Inc., P.O. Box 9090, M/S 250C, Everett, WA 98206-9090. U.S. (206) 356-5400. Canada (416) 890-7600. Other countries: (206) 356-5500. ©1992. All rights reserved. Registered T.M. of Advanced Micro-Devices and Intel Corp. Ad No. 00178.

FAST ANSWERS

**FLUKE®**

COMPUTERS & SUBSYSTEMS

this can be dealt with by using the data strobe lines DS0 and DS1 alternately, and the bus will still run at very high data rates.

**A little adjustment**

In the end—or at least thus far—a little adjustment is what both the proposed SSBLT approach and the VMEbus specification received. When Nattkemper's results were reviewed, they were seen to have some

much more robust version of the VMEbus specification than the original document calls for." Virtually all VME boards and systems built today implement the modifications called for by this more robust version of the standard. Also, boards built to either the old or the proposed revised version of the specification are fully compatible.

One significant modification calls for a change in drive current from 48

SSBLT approach will be totally reliable. In addition, the SSBLT strobe has been moved from the beginning to the middle of the data period to further eliminate time quantization of data.

**Reduced capacitive loading**

Besides the tighter transceiver specifications, the new proposal calls for reducing the capacitive board loading from 24 to 16 pF, and tightening the backplane impedance to make it look like 100 W. This lets the backplane take advantage of a transmission-line effect. Also, as part of the specification's amendments, a shielded DIN connector will be optional.

Though it appears the specification is headed for certain approval, there are still some in the VME community who are sitting on the fence. "I'd like to see the VME capability expanded, and certainly the type of transfer rates being discussed would be an advantage," says Pete Yeatman, president of Radstone Technology (Montvale, NJ). "But such an addition is going to have to be completely compatible with, and transparent to, the existing standard."

"The installed base," continues Yeatman, "is too large and too important to risk with an addition to the specification which may or may not work, or may or may not be fully compatible." While he sees some strong advantages to the faster transfer capability, Yeatman says he wants to make sure it's fully tested before it's incorporated into the specification. ■

**SSBLT timing delays**

<b>Source effects</b> - logic that generates data/clock (delta time) - delta driver skew - delta driver slew - delta stub skew	5 ns 5 ns 1 ns 1 ns <b>Total= 12 ns (max)                      3 ns (min)</b>
<b>Backplane effects</b> - delta skew (delta velocity) - delta slew (bandwidth limit) - delta clock/data setting	5 ns 1 ns 33 (41) ns <b>Total= 39 ns (max)                      0 ns (min)</b>
<b>Desitination effects</b> - delta stub skew - delta receiver threshold - delta receiver skew - logic setup	1 ns 1 ns 5 ns 3 ns <b>Total= 10 ns (max)                      3 ns (min)</b>
<b>Other effects</b> - logic quantization time (50 MHz, 0.5 clk) - logic hold	10 ns 3 ns <b>Total= 13 ns (max)</b>

*The source, backplane and destination effects produced by the SSBLT protocol result in a worst-case delay of 61 ns, which must be added to 13 ns from other effects. This mandates a significant timer delay—in the area of 55 ns to the standard VME timing. In total, source, backplane, destination, and quantization delays result in a combined delay of 126 ns.*

merit, but were criticized as being too pessimistic. But even strong proponents of SSBLT were willing to admit that the approach could experience problems in systems which implemented the VME specification as written.

Everyone was using the timing parameters described in the initial VMEbus specification for their SSBLT models. "But," comments Fischer, "the VMEbus specification was written more than ten years ago and the state of the technology, particularly for transceivers and backplane design, has changed. Systems made today—even those made a few years ago—use improved transceiver components, backplanes, boards, and, in truth, implement a

to 64 mA for all address and data lines. Although virtually all the drivers available today implement the 64-mA drive current, the specification still calls for the lower current. In addition, the new proposed specification calls for tighter threshold characteristics for the transceivers. The threshold will be reduced to 200 mV, with the low level (or 0) at 1.4 V and a high level (or 1) at 1.6 V. "This will bring the transmission characteristics closer to incident-wave switching, such as that used in Futurebus+," says Fischer. Though not a true incident-wave transmission system, the tighter parameters of the revised spec will clean up waveforms and remove the effects of reflections sufficiently that the

*For more information about the technologies, products or companies mentioned in this article, call or circle the appropriate number on the Reader Inquiry Card.*

- Force Computers**  
(408) 370-6300 ..... Circle 234
- Matrix**  
(919) 231-8000 ..... Circle 235
- Newbridge Microsystems**  
(613) 592-0714 ..... Circle 236
- Performance Technologies**  
(716) 256-0200 ..... Circle 237
- Radstone Technology**  
(201) 391-2700 ..... Circle 238
- VITA**  
(602) 951-8866 ..... Circle 239

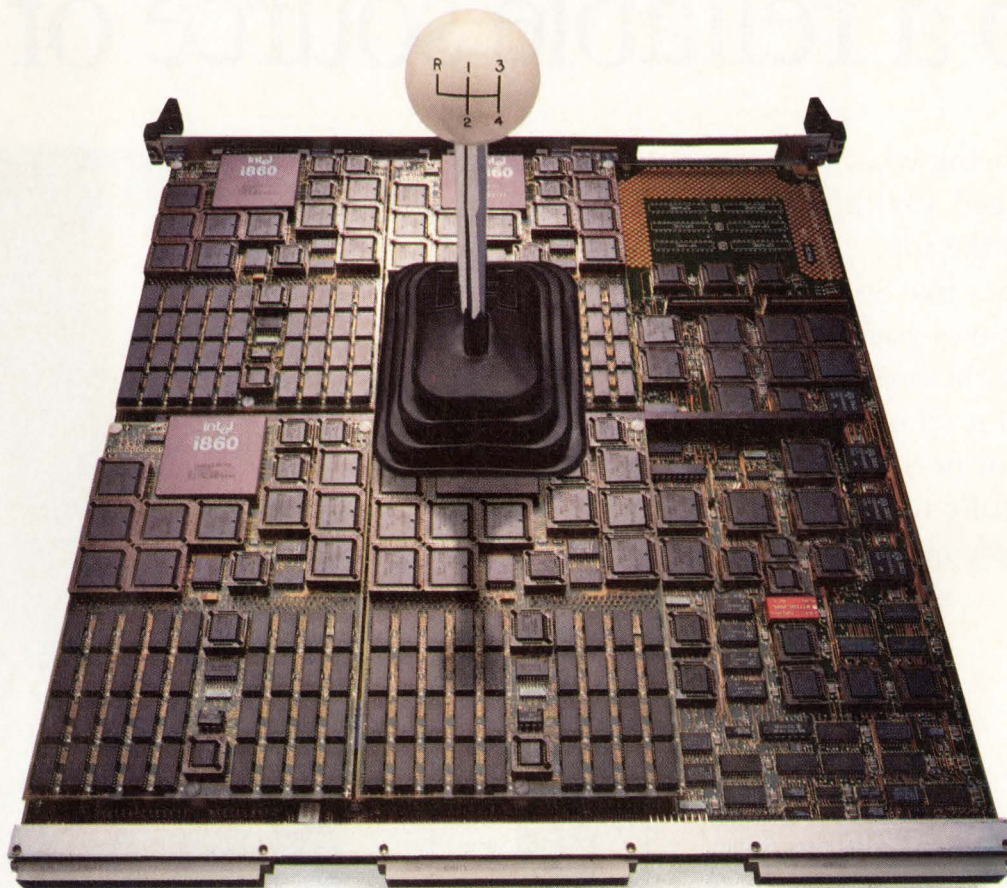

**THE ONLY ATTACHED PROCESSOR  
WITH FOUR ON THE BOARD  
AND 2.5 GIGAFLOP PERFORMANCE.**

Mercury's MC860VS. The only attached processor that offers up to 32 Intel i860s in no more than 8 VME slots. So you get 80 Mflops to 2.5 Gflops of horsepower to handle demanding applications in defense signal processing and medical imaging. And all Mercury products can be configured in workstations and chassis systems to deliver scalable performance at a scalable price.

So if you're building or buying a high performance computing solution, take full advantage of Mercury's unparalleled investment in standards, innovative hardware, and software development environment. And get the most complete, flexible, high performance computing solutions available. If it's time you moved into the fast lane, it's time to call or write Mercury today for more information.

- Please send me more information on the MC860VS right away.
- I want to learn more. Send me your white paper "Multiprocessing for the 1990s" and enroll me in your Education Series program today.

Name \_\_\_\_\_  
 Title \_\_\_\_\_  
 Company \_\_\_\_\_  
 Address \_\_\_\_\_  
 City/State/Zip \_\_\_\_\_  
 Phone \_\_\_\_\_

Please send to  
 600 Suffolk Street,  
 Dept. K,  
 Lowell, MA 01854  
 Fax (508) 458-9580  
 (508) 458-3100



CD 6/92

CIRCLE NO. 36

**The Ultimate Performance Machine.**

See us at AFCEA, June 23-25, Washington, D.C., Booth #235

# Tap a reliable source of DSP

Times being what they are, now more than ever you need a faithful partner who can help you rise to the top.

A partner like Spectrum Signal Processing. One who saves you time, money and headaches by offering the broadest range of off-the-shelf DSP board-level solutions available. Solutions that fit your needs and put DSP to work. Each one fully tested. Fully warrantied. And easy to implement.

Buses	I/O Options	All major DSPs
PC/AT	32 channel analog	TMS320C40
VME	16 channel analog	TMS320C30
SBUS	1 MHz transient capture	TMS320C50
Media~Link™	SCSI direct to disk	TMS320C25
	AES/EBU digital audio	DSP96002
	Multiprocessing	DSP56156
	communications	DSP56001
	Frame grab/display	ADSP-21020
		ADSP-2101
		ADSP-2100
		DSP32C

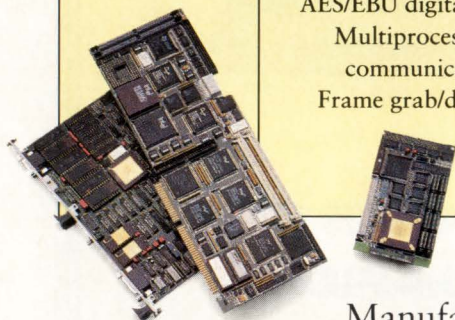

All backed by our  
Manufacturing Resource

Planning System. That means the best service for you. From production scheduling to order processing. Plus, we provide complete support including extensive documentation, development software, applications notes and engineering assistance.

So go to the source that's gushing with DSP solutions by calling today for your free catalog or a distributor near you: 1-800-663-8986 (Western U.S.), 1-800-323-1842 (Eastern U.S.) or 604-421-5422 (Canada).



CIRCLE NO. 37



Old Faithful, Yellowstone National Park

# solutions from Spectrum.



©1991. Spectrum and Media-Link are trademarks of Spectrum Signal Processing, Inc. All other trademarks are trademarks of their respective holders.

## Alliances help bridge the gap between IC design and test

Mike Donlin, Senior Editor

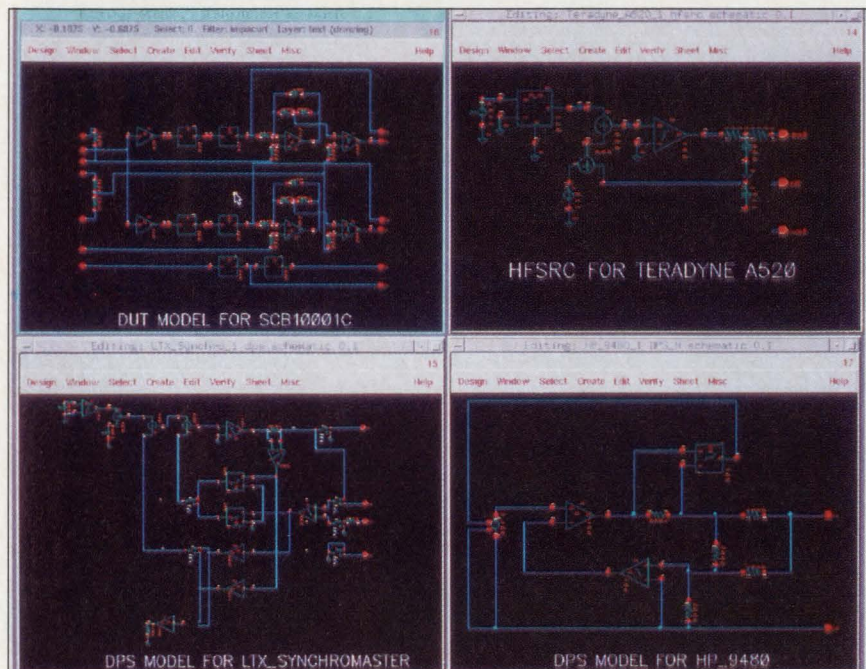

In this photo of Cadence's recently introduced Dantes tool, the upper left window shows a model of a device under test (DUT). The remaining three windows show tester resource models provided by several ATE vendors. The upper right window shows the model for the high-frequency source for the Teradyne A520. The lower left window contains the DUT power supply (DPS) model for the LTX Synchromaster. The lower right window shows the DPS model for the HP 9480.

The increasing complexity of ICs is making prototype verification and failure analysis more daunting than ever before. Trying to locate and probe a single transistor or even a bank of transistors in a sea of millions of components can challenge even the most sophisticated test systems. The obvious solution would be to use the design, layout and simulation data that was used to develop the device to guide the test equipment through the maze of components to find the suspect portion of the circuit. Test equipment and EDA vendors are beginning to work together to bring about such a link, but the going has been rough.

"Both the EDA and test industries grew up independently," says Thomas Sherby, chairman and CEO of Knights Technology (Santa Clara, CA). "Consequently, the tester people don't understand the EDA world

very well, and the EDA people don't know how to interface their software to all the various pieces of equipment that make up a test area. A lot of valuable data that was developed during a device's design has never made it over to the test area simply because neither side wanted to take the time and use the resources to interface one to the other."

A recent alliance of Cadence Design Systems (San Jose, CA), Integrated Measurement Systems (IMS—Beaverton, OR), Knights Technology, and Wentworth Laboratories (Brookfield, CT) is geared toward breaking down the barriers that have separated these disciplines. The resulting system, which IMS calls the Analytical ProbeStation, gives test engineers the ability to observe and insert data into internal nodes of an IC while using CAE/CAD data to guide a probe to

the suspect portion of a circuit.

"Our customers have had difficulty integrating all of these separate elements in the past," says Steve Morris, director of marketing at IMS. "Companies have had to use teams of engineers to connect a test system to stimulate the device, a prober to test internal nodes, a floating table to reduce the effects of vibration, fixturing to connect the tester to the device installed in the prober, and software to automate probe positioning. This takes a lot of effort to get all the parts working together, and our customers are telling us they just don't have the resources to do that."

### Connecting the pieces

The alliance that IMS has forged with Cadence, Knights and Wentworth brings together the various pieces of equipment and software to answer these complaints. The IMS portion of the package—its family of device testers—supports components with up to 448 I/O pins. Wentworth Laboratories provides its CAP-4000 programmable probe head with 0.1- $\mu$ m resolution and a floating table to isolate the device from mechanical vibration. The CAP-4000 also controls a microscope mount for visual guidance and a laser cutter for passivation removal or machining vias to access buried layers.

Cadence's schematic, netlist and layout databases provide the front-end design information to the system, while Knights Technology is responsible for the software that ties the ProbeStation together. Knights' Merlin Framework lets you control a variety of post-silicon test and modification procedures from a Sun workstation. The software uses a multiwindow technique to let you view layout, netlist or schematic data to navigate the other portions of the ProbeStation to the feature of interest on the silicon. Additional windows let you view outputs from the test equipment, such as the image from the microscope, and to acquire, display, store, and recall signals for analysis.

"We think that this link between CAD data and physical test is especially important for analyzing today's complex circuitry," Knights' Sherby points out. "A typical microprocessor design has well over a million transistors. Trying to find a



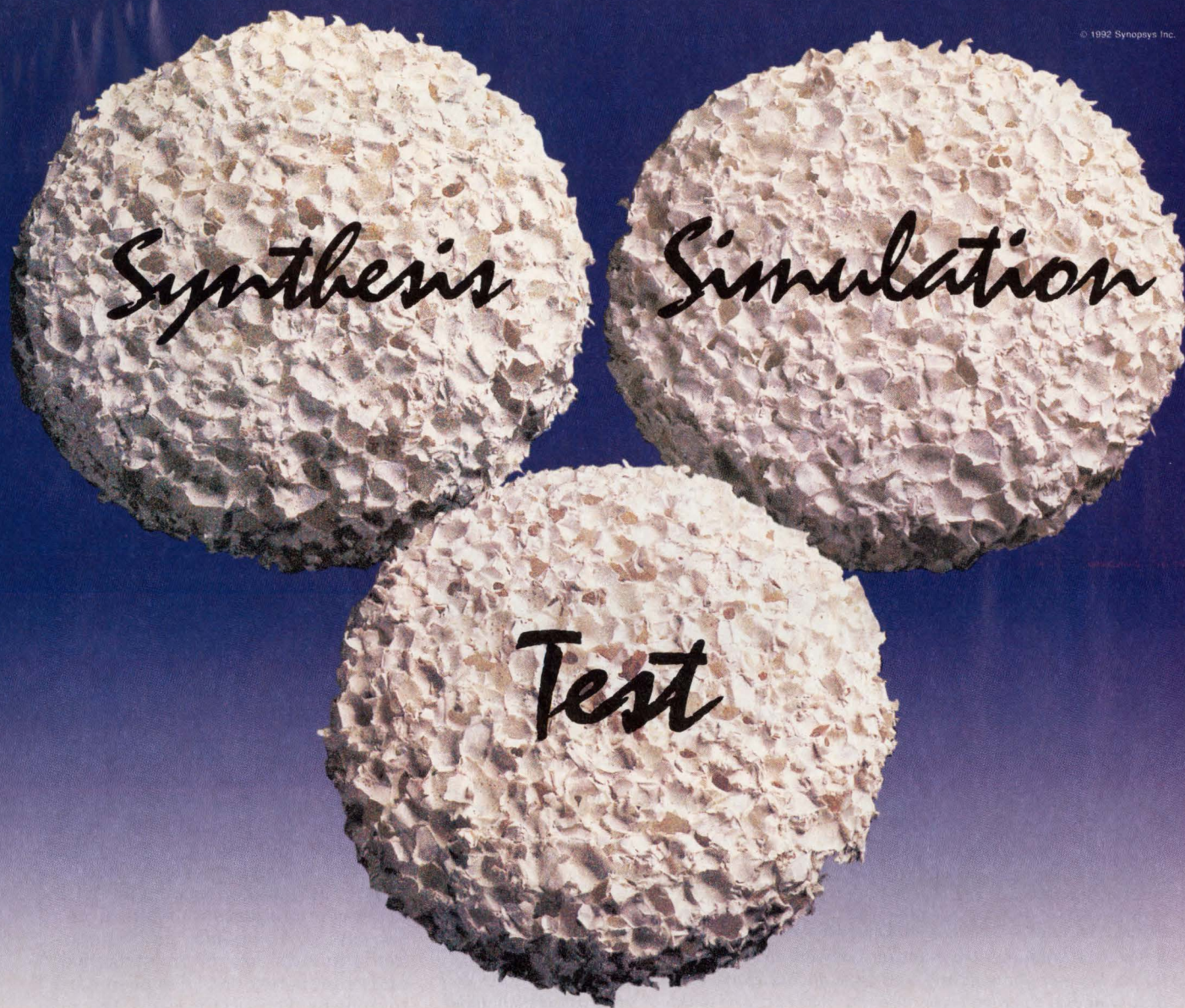

# High-level predictability.

40 MHz, 60K gates in two months, working on first silicon, with 99% fault coverage. An impossible dream? Not to the thousands of designers who have been using our high-level design methodology to produce systems working in the real world. The ability to analyze and correct the functionality of your system before you commit to silicon comes from our unique blend of high-level design tools: high-level and gate-level simulation, *production-proven* synthesis, and test synthesis. We can help you put high-level design to work today. Call 800-388-9125 for your own free guide: "Making the Transition to High-Level Design."

FAX: 415-965-8637

See us at DAC. Booth #1721

**synopsys**<sup>®</sup>  
HIGH-LEVEL DESIGN

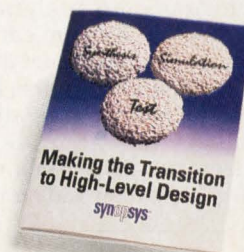

## CAE/CAD TOOLS

problem is like looking for a needle in a haystack. At least with this approach, we let you look at the whole haystack. After problems are isolated and solved, it's important to go back and change your CAD database so that the design information reflects the changes made."

Knights' software also works with E-beam equipment, which gives a more detailed view of the silicon under test and doesn't re-

as our entire system, about \$400,000."

### ■ The ATE connection

Partnerships such as those forged by IMS focus on the probe and test of individual designs and single pieces of silicon, but there's also been activity in the automatic test equipment arena to bridge the gap between high-volume device testing and CAE data. Cadence has recently unveiled

to properly verify functionality and parametric performance. This labor-intensive effort can often delay prototype development and product shipment, which, in turn, increases costs."

Dantes was developed in cooperation with several leading ATE vendors, who provided tester-specific information that can be ported to the design phase of the device. At present, Dantes can generate source code for the Teradyne A500 series of testers as well as the LTX Synchro-master, the Hewlett-Packard 9480 and the Yokogawa TS-1000. The tools in the suite include a test rule checker to ensure that designs will be testable once they reach the tester floor; a composer tool to assist in the development of the device under test loadboard design; a test sequencer to order and prioritize tests; and test program generators to automatically create test programs.

Though the IMS partnership and the Cadence software target different portions of a device's design cycle, they both signal a trend in the IC industry. Test bottlenecks have long been the bane of both design and test engineers, who've had to work in isolated environments with little communication between the two camps. As a result, time-to-market windows are often stretched, and reliable test data has been hard to come by. The alliances of CAE and test vendors must certainly be welcome for designers who want to make their designs testable and for test engineers who want to ensure that their test vectors are accurate and exhaustive.

But, integrating the needs of design software vendors, the ATE community and leading IC houses will remain a challenge for some time, because until recently each assumed the burden of testability was the responsibility of the other. ■

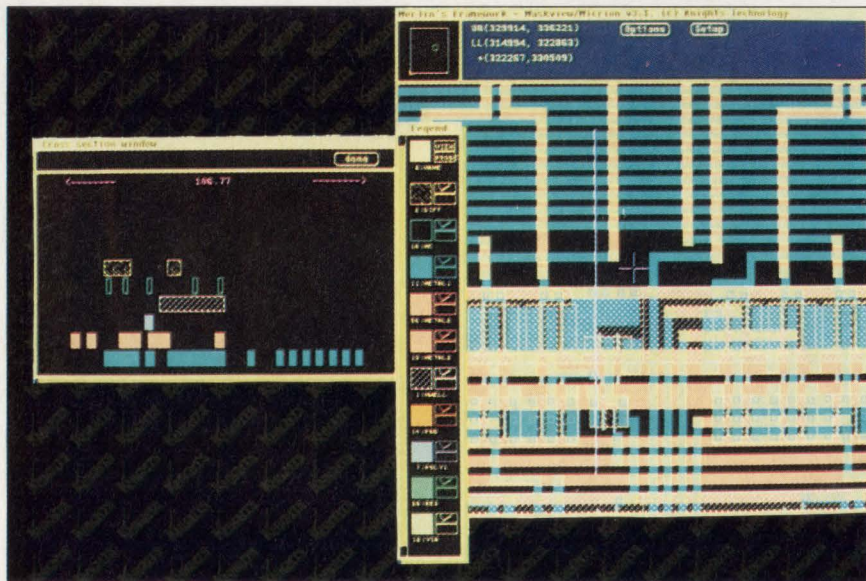

Knights Technology's Cross-Section Tool lets you draw a line on the silicon mask (white line in right window), and gives an idealized cross-section view of the device (left window) showing layer ordering, thickness and width of the cross-section under the selected line. The middle window gives a color-coded guide which shows what material is visible in the cross-section and lists its function. This information is useful when it's necessary to open holes in passivation or modify the device with a laser.

quire physical contact with the device like a prober does. "We feel that E-beam and CAD integrated analytical probing are different and generally complementary, not competing technologies," says IMS' Morris. "E-beam equipment can be used in a dynamic imaging application to scan voltage contrast images of a faulty IC so it can be compared with a good IC. You can't do that with physical probers. On the other hand, there are several things that an analytical prober can do that an E-beam can't. A physical probe lets you insert data instead of just sensing it. It also lets you probe two or more nodes simultaneously and get very accurate voltage measurements. An E-beam needs a vacuum chamber and can cost as much

Dantes, an analog and mixed-signal design-to-test product. Dantes is a bidirectional design and test environment which integrates Cadence's Analog Artist Design System into the ATE environment, a coupling which lets you incorporate test specifications early in the design cycle.

"The test development process for analog and mixed-signal circuits is an area where little progress has been made," says Thomas Quan, director of analog IC solutions at Cadence. "In the digital arena, widely accepted testability metrics have been developed. But for analog and mixed-signal designs, the IC vendor's test engineer is still required to interpret the design specification. The engineer must construct test hardware and generate code for ATE

For more information about the technologies, products or companies mentioned in this article, call or circle the appropriate number on the Reader Inquiry Card.

Cadence Design Systems (408) 943-1234	Circle 207
Integrated Measurement Systems (503) 626-7117	Circle 208
Knights Technology (408) 988-0600	Circle 209
Wentworth Laboratories (203) 775-0448	Circle 210

BUSCON  
'91 East  
Product of the Year.

# The competition will call us ruthless. You can call us at 1-800-234-4VME.

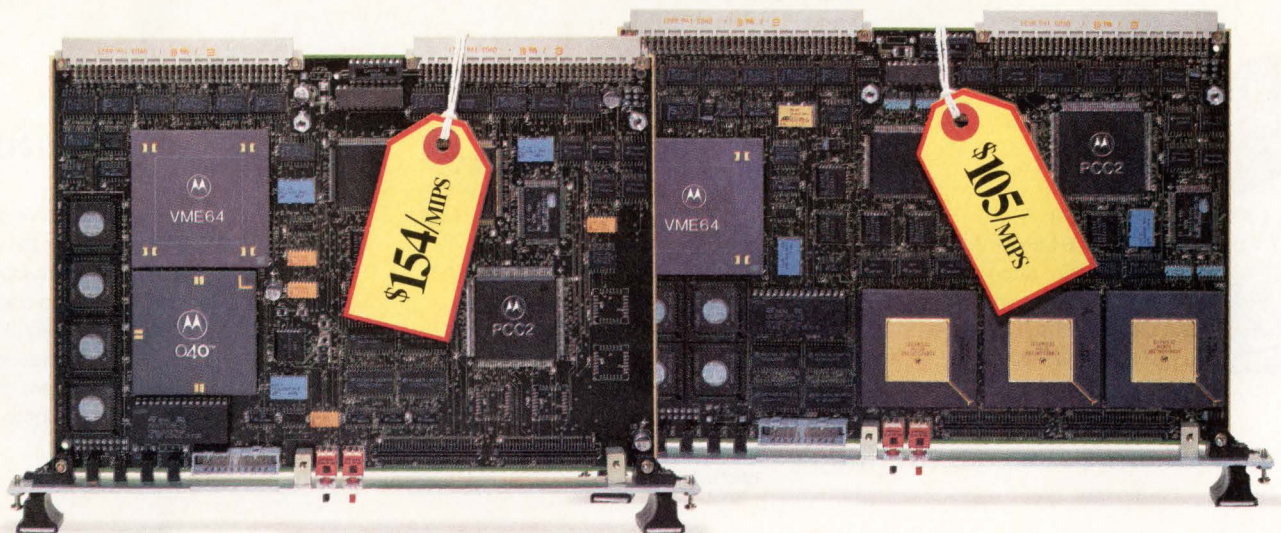

It's enough to make other VME board builders call us names. Or call it quits. A new 38 MIPS\* VME single board computer based on the 88100 RISC microprocessor. Or a new 26 MIPS\* VME board based on the 68040 CISC microprocessor.

Both are built by Motorola and offered at \$3,995 each. That's just \$105/MIPS for the RISC board, which compares nicely with the \$1,000/MIPS you've been asked

to pay for somebody else's board. And it's just \$154/MIPS for the CISC board.

The MVME187 (RISC) and MVME167 (CISC) boards employ VME D64 architecture. And both come with four 32-bit timers.

For a free color brochure, call the 800 number above. And see why the competition undoubtedly wishes we'd call the whole thing off.



**MOTOROLA**  
Computer Group

Motorola and the  are registered trademarks of Motorola, Inc. © 1992 Motorola, Inc. All rights reserved. \*MIPS rating based on Dhrystone 1.1 test results where 1757 Dhrystones/s is 1 MIPS (VAX® 11/780). MIPS performance is based on the Diab 2.36E compiler.

CIRCLE NO. 39

# Seven **Hot** Reasons Why Your Next SBC Should Be a SPARCard



## First

Our new SPARCard™ 2LC is the first and only VME SBC with SPARCstation 2™ performance. The 2LC has complete Sun compatibility on-board to put your workstation software to work in demanding real-world target applications like robotics and voice recognition systems.

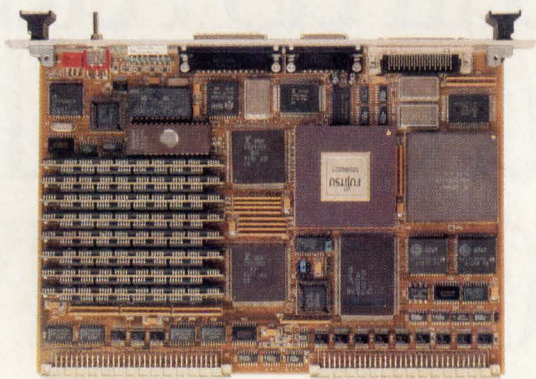

## Real Time Choices

Choose between LynxOS, VxWorks and VADSworX to cover any real-time requirement. Wind River's VxWorks is the standard for embedded real-time applications. VADSworX speaks ADA. Or use LynxOS for a POSIX or UNIX compliant kernel in the target system. Any way you choose, Themis has the software for your real-time environment.



040 x 2  
=28.5

With 28.5 Mips of integer performance, the 40 MHz SPARC MPU is more than twice as fast as the 68040. A larger 64KB cache and combined MPU/FPU put the SPARCard 2LC in a class of its own.



## 64/32 64-Bit Architecture

The SPARCard is the only SPARC VME SBC built on the MBus, Sun's sophisticated 64-bit local bus. Used in the SPARCserver 600 MP Series, the MBus offers 64-bit paths to internal devices and memory for fast system throughput. Advanced ASICs designed specifically for the MBus guarantee performance and reliability.

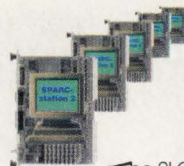

## The Future

The 2LC is just the beginning. Themis is producing an entire family of SPARC 2-based products for every embedded application, including those requiring SBus modules. For more information contact Themis Computer, the sole source for VME SPARCstation 2 performance.



## SPARC 100% Pure SunOS

We're partnered with SunSoft, a division of Sun Microsystems and developer of Solaris, Sun's newest operating system. So we guarantee full SunOS compatibility including: SunOS 4.1.1, Open Look, Open Windows, and ONC/NFS. All Sun application software and development tools run on a SPARCard without modification.

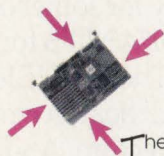

## Fully Loaded

The SPARCard 2LC is a complete system on a card. Everything's on-board, including: 8-32 Mbytes DRAM, Ethernet, SCSI, VME interface, Open Boot PROM, Non-volatile SRAM, and two Serial Channels. Its MBus/VMEbus Controller has data FIFOs and hardware DMA for blazing VME performance.



**THEMIS COMPUTER-Americas and Pacific Rim**  
6681 Owens Drive, Pleasanton, CA 94588  
Phone (510) 734-0870, Fax (510) 734-0873

**THEMIS COMPUTER-Rest of World**  
1, Rue Des Essarts, Z.I. De Mayencin,  
38610 Gieres, France  
Phone 33 1 76 59 60 61, Fax 33 1 76 63 00 30

SPARCard trademark pending approval by SPARC International. All others are trademarks of their respective companies.

CIRCLE NO. 40

# Peripheral interfaces offer fast networking solutions

*HiPPI and Fiber Channel may have been defined as peripheral interfaces, but designers are taking advantage of their high data transfer rates to solve their networking problems.*

Warren Andrews,  
Senior Editor

**H**igh-speed processors and complex applications demand more from a system's memory subsystems and I/O interfaces. With processor clock speeds running at better than 50 MHz—and going up all the time—and the increasing emphasis on graphics, imaging, multimedia, and hypermedia, the amount of information to be transferred from one subsystem or processor to another is enormous.

In response to these very high-speed data transfer requirements, fast copper-cable and fiberoptic interfaces are starting to emerge. While some follow protocols such as SCSI, HiPPI and Fiber Channel, others are basically proprietary—their manufacturers are not waiting for the resolution of standards issues. And, protocols such as HiPPI and Fiber Channel were defined for peripheral interfaces, there's a growing tendency to take advantage of their high data-transfer rates for larger network interfaces such as LANs.

"The idea behind any peripheral interface," says Joel Silverman, marketing manager for commercial products at Radstone Technology (Montvale, NJ), "is to move data as quickly as possible from the host or subsystem to the peripheral and back. Also, the architecture of the host bus adapter must be suited to swapping data across the peripheral bus with as little overhead as possible on the main system bus or main processor."

For the SCSI-1 generation, with a maximum transfer rate of only about 5 Mbytes/s in a synchronous mode, even moderate demands can keep the SCSI bus busy; all that needs to be done is to isolate the SCSI channel from the host bus. But the emergence of SCSI-2 (see "The emergence of SCSI," p 65), with its attendant fast and wide interface, has let data rates reach



*Broadband Communications is releasing a new HiPPI-to-fiberoptic module for OEMs to use on board- and system-level products. Broadband president Jim Toy points to the compact size of the new module and says it will fit on many standard board architectures or motherboards.*

## ■ PERIPHERAL INTERFACES

20 Mbytes/s for a 16-bit bus width and 40 Mbytes/s for a 32-bit bus width. Such rates are at the theoretical limit for VMEbus transfers, and far exceed real-world transfer rates; in many traditional applications, they can't be utilized at either the source or destination.

But this scenario will change rapidly as new technology invades the traditional I/O world. RAIDS (Redundant Array of Inexpensive Drives) approaches, for example, are surfacing that are capable of using bandwidths of 40 Mbytes/s and more. And devices such as scanners, high-speed printers and other

as well as even the fastest SCSI performance doesn't come close to matching system needs. Very high-performance RAIDS arrays, for example, are capable of bursting data at rates far faster than current SCSI allows. Also, to solve real-time (and not-so-real-time) high-resolution imaging problems, technologies faster than SCSI have had to be developed.

### ■ A supercomputer start

Not unexpectedly, many high-speed I/O interfaces were born in the supercomputer world. HiPPI, one of the first standard high-performance

point-to-point channel between CPUs, and from CPUs to storage systems, printers and other peripherals. Its specification calls for 32 data lines, four parity lines and an assortment of control lines in each direction. It also defines many layers, including a physical layer, framing protocol, link encapsulation, memory interface, and switch control. In addition, the ANSI Committee is busy looking at other protocols to include in the specification.

HiPPI was initially designed to be implemented with relatively inexpensive, readily available components to encourage rapid acceptance by a large number of users. But those same factors, along with the need for a large bundle of copper wires (almost 100 for a 32-bit bidirectional connection) and a limitation on distance to less than 25 m, may well limit the lifetime of traditional HiPPI and pave the way for other approaches.

Alternatives such as fiberoptic versions of HiPPI are already emerging, and the committee assembling the Fiber Channel specification is in the process of adding HiPPI protocols as a subset of its document. "But," says Jim Toy, president of Broadband Communications (Melbourne, FL), "the practical implementation of Fiber Channel is still a ways off, and HiPPI, particularly as implemented in optical fiber, will continue to be a major winner."

### ■ Growing base of users

HiPPI is currently in use—or under development—by most of the major supercomputer makers, including Convex, Cray Research, Digital Equipment Corporation, IBM, Intel Supercomputer, Network Systems, Thinking Machines, and others. Although the interface hasn't yet made its mark on smaller systems, Sun Microsystems has been participating in developing the specification—the only workstation maker to do so—and IBM is reportedly looking at a HiPPI interface for its RS/6000 family, as is Silicon Graphics.

"HiPPI is a very convenient way to interconnect major subsections of a system with the kind of transfer rate needed for things such as real-time graphics," says Jim Hanlon, director of marketing for IOTEK (Halifax, Nova Scotia). "Our system comprises two units: a powerful signal processor and a high-resolution display processor. Because of the tremendous amount of data that has to flow between the two units, we

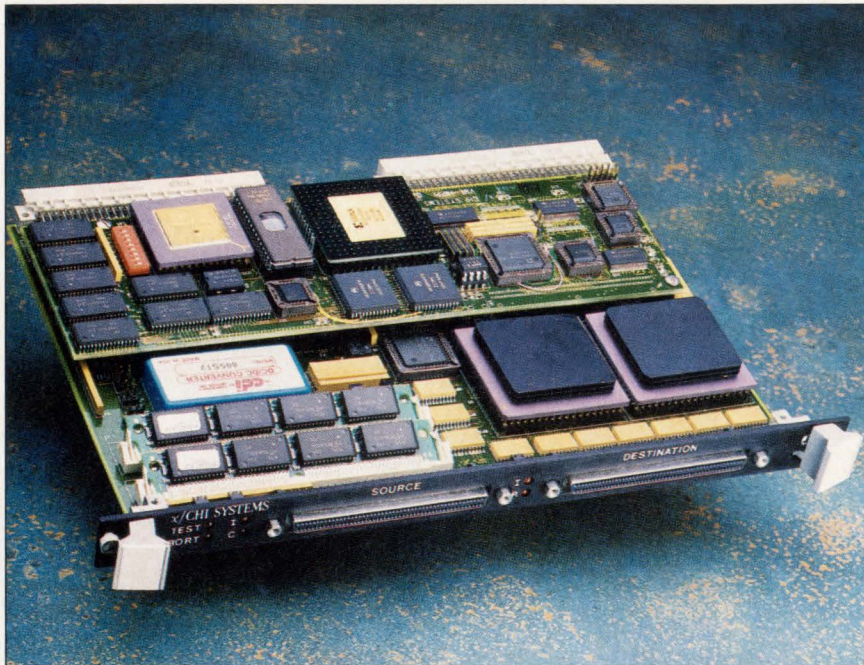

*Chi Systems is one of the only companies to make a HiPPI interface on a standard VME module. Says company vice-president Douglas Felder, "While our VME board fits the bill well in many applications, SBUS, with its faster transfer, can better take advantage of HiPPI capabilities."*

subsystems tied into the I/O interface will continue to make new performance demands.

With the introductions of fast and wide SCSI and a number of interface chips from the major manufacturers supporting this latest revision, SCSI is holding its own in many traditional applications such as disk drives. "In many system applications," says Silverman, "SCSI can even be used as a small network where other networks such as Ethernet or token ring approaches are too expensive or complex."

SCSI will undoubtedly continue to be an industry leader in many application areas for quite some time. But there are many other ar-

I/O interfaces, got its start as a "high-speed channel (HSC)" project undertaken by a group including Cray Research, IBM and Los Alamos National Laboratories. The project, subsequently adopted by ANSI, became the X3.183.199X High-Performance Parallel Interface, with both the HiPPI and HiPPI acronyms deemed correct. Cray Research was one of the first implementers of the approach.

HiPPI is defined as an I/O channel supporting a bandwidth of 800 Mbits/s, with an alternate transfer rate of double that—or 1.6 Gbits/s, achieved by doubling the bus width from 32 to 64 bits. The primary design goal of HiPPI is to provide a

# Radstone reveals an ancient technique for designing an ultra high performance VME system...now.

*Lurking right there in the VMEbus designer's bag of powerful tricks is the overlooked, under-utilized and very potent VSB with all of its board and system enhancing features. There's even a complete range of VME/VSB boards just waiting to be designed into a superfast, super-flexible system...right now.*

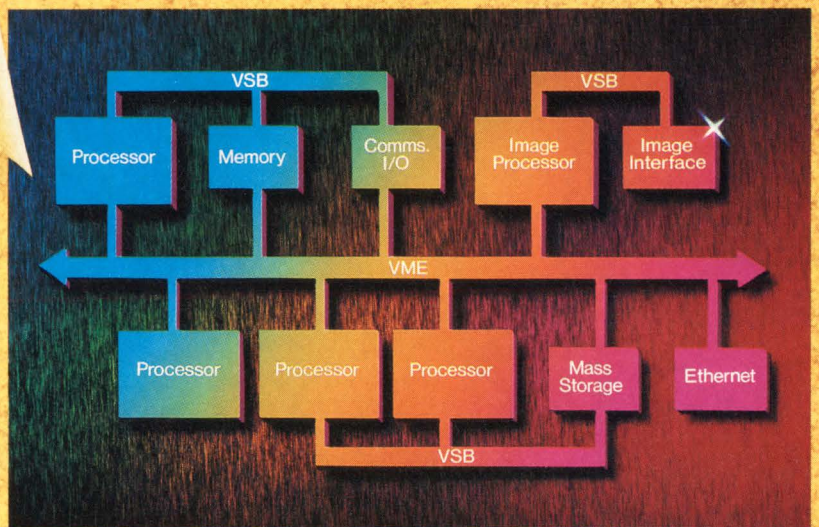

*A multiple systems-within-a-system architecture forming tightly coupled sub-systems capable of independent and parallel operation.*

The VME Sub-system Bus gives you...

- A proven system solution that's multi-vendor sourced and industry accepted.
- Highly flexible multiple bus capability today.
- Multiple systems within a system.
- Wide range of products: CPUs, I/O and memory.
- Freeflow+ architecture that eliminates system bottlenecks.
- Increased system efficiency: VSB for data/VME for message passing.

If you're looking for a way to get *next generation* bus architecture performance right now, look at VSB. Radstone will support your efforts with the world's most complete line of VME/VSB processor, I/O and memory boards and the world's *only* line of Freeflow+ architecture boards. Call us to take advantage of the ancient wisdom of VSB...now.

**Radstone Technology Corporation**  
20 Craig Road, Montvale, NJ 07645-1737  
**Call Toll-Free: (800) 368-2738**  
Eastern Region: (201) 391-2700  
Central Region: (708) 304-0202  
Western Region: (408) 727-4795

**CIRCLE NO. 41**

  
**RADSTONE**  
TECHNOLOGY

# National announces quiet revolution

The cry for low-noise 3-volt logic has never been louder. That's why we're leading the charge with our new LVQ (Low Voltage Quiet) logic.

Every member of this complete family of gates, multiplexers, flip flops, and octals is fully specified for the 3.3V world of





# ounces the in 3-volt logic.

battery-operated computing. As a result, LVQ is ideal for everything from laptops and notebooks to palmtops and pen-based systems.

LVQ is extremely quiet. Its reduced voltage swings go a long way towards minimizing noise on octals (guaranteed  $V_{OLP}/V_{OLV} = \pm 0.8V$ ) and EMI—especially critical to miniaturized designs,

and cumbersome shielding. LVQ is low power. Make that ultra-low power, as in  $50\mu A$ . And that's a specification we guarantee. So now you can count on much longer battery life, while maintaining the speeds required to optimize your 33MHz designs.

LVQ is also very compact. Its revolutionary new package

where there's simply no room for elaborate design (QSOP, or quarter size outline package) not only makes LVQ smaller, but provides greater functionality and enhanced thermal conductivity. Not to mention increased board space.

Even though it offers all these advantages, LVQ delivers the best

price/performance of today's 3V solutions.

And while the family comprises 19 parts, it's just

the beginning. In fact, LVQ is part of a much larger, company-wide commitment to provide a comprehensive selection of innovative low-voltage solutions—now including EPROMs, power management, interface, data acquisition, audio/video, and voltage reference products.

All of which proves that our quiet revolution is definitely a movement in the right direction.

#### LVQ FEATURES

- $V_{OLP}/V_{OLV} = \pm 0.8V$  guaranteed
- Negligible EMI
- $I_{CC} = 50\mu A$  max
- QSOP packaging
- 9ns prop delay
- Hands-on application assistance on dual voltage designs
- Samples available for 5- to 3-volt translation (LVX244)

#### LVQ PORTFOLIO

74LVQ00	74LVQ157
74LVQ02	74LVQ174
74LVQ04	74LVQ241
74LVQ08	74LVQ244
74LVQ14	74LVQ245
74LVQ32	74LVQ273
74LVQ74	74LVQ373
74LVQ86	74LVQ374
74LVQ138	74LVQ573
74LVQ151	

Join the revolution today!

For free samples, give us a call today: 1-800-NAT-SEMI, Ext. 197.  
Or fax: 1-800-888-5113.

 **National  
Semiconductor**

NORTH AMERICA: P.O. Box 7643, Mt. Prospect, IL 60056-7643 (Tel: 1 800 628 7364, ext. 197; Fax: 1 800 888 5113); EUROPE: Industriestraße 10, D-8080 Fürstfeldbruck, Germany (Tel: 49 8141 103 0; Fax: 49 8141 103 515); HONG KONG: 15th Floor, Straight Block, Ocean Center, 5 Canton Rd., Tsimshatsui, Hong Kong (Tel: 852 737 1654; Fax: 852 736 9921); JAPAN: Sanseido Building 5F, 4-15-3, Nishi-shinjuku, Shinjuku-ku, Tokyo, Japan 160 (Tel: 81 3 3299 7001; Fax: 81 3 3289 7000).

©1992 National Semiconductor Corporation.

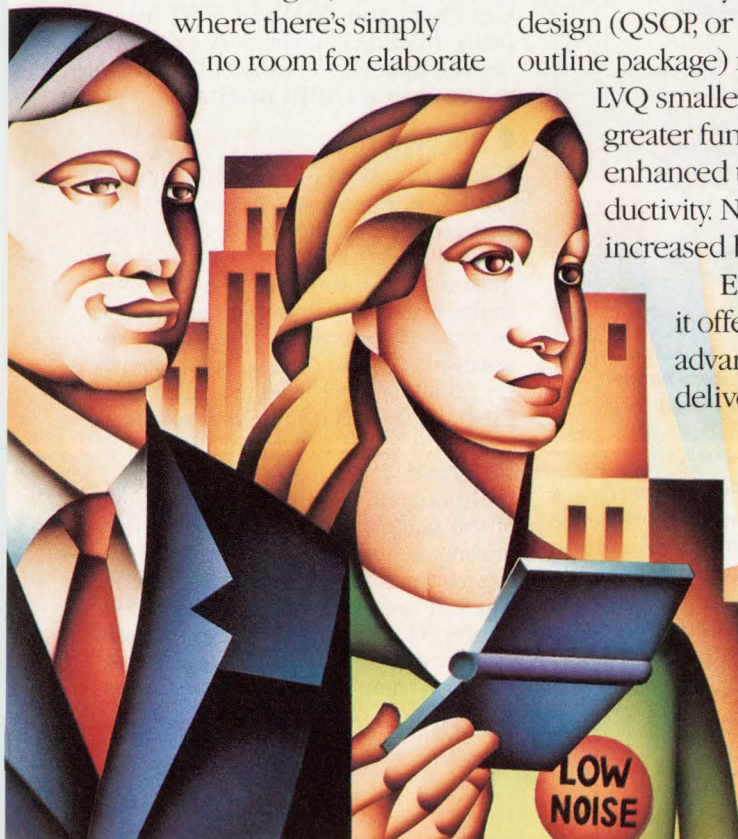

## PERIPHERAL INTERFACES

had to find a high-speed I/O channel and HiPPI fit the bill. And, since the two units are always in the same room and never more than several feet apart, the relatively low cost and straightforward approach of the copper cable works well. But it's good to know that a fiber version is available, just in case circumstances should warrant it."

### On standard platforms

Because of its growing use in a variety of systems other than supercomputers, HiPPI has spawned some

for high-performance data acquisition systems, many of which are built for large government projects.

Says Douglas Felder, vice-president of sales and marketing at Chi, "Our present commercial VME products emerged from some very specific high-end, high-speed data-acquisition government projects. But VME is still relatively slow and we're currently working on an SBus version of our HiPPI adapter. Because the transfer rate of SBus is much greater than that of VME [160 Mbytes/s versus 40 Mbytes/s for

the requisite circuitry and connector on the very small form factor SBus card, Chi Systems will have to use two SBus slots for its SBus-to-HiPPI adapter.

"In putting together our HiPPI products, we're defining and developing specific hardware platforms and adding critical software components," says Felder. "For example, the company offers drivers for Sun machines and Silicon Graphics workstations, as well as drivers for such networking protocols as TCP/IP. In addition, we're doing some custom interfaces in conjunction with a consortium known as the National Storage Lab."

The National Storage Laboratory—a group of companies working with Lawrence Livermore Laboratories and including Ampex Tape Systems, General Atomics, IBM Federal Systems, IBM Storage Systems, Maximum Strategies, Network Systems, and Zitel—is putting together a test bed of storage devices tied together with a HiPPI interface. The object is to demonstrate that it's possible to transfer data to and from mainframes and workstations at HiPPI rates.

"Until now," explains Felder, "such transfers were limited to FDDI [Fiber Distributed Data Interface] raw data rates of 10 Mbytes/s. Now we're able to increase that by an order of magnitude, to 100 Mbytes/s. Chi is participating in the project by providing Sun-, Silicon Graphics- and Zitel-to-HiPPI interfaces. In addition, we're also supplying the upper-level protocol for IPI-3 to run over a HiPPI interface."

### The next step

Despite the seeming success of HiPPI, it hasn't yet achieved wide acceptance outside the fringe of supercomputer makers. Cabling requirements and distance limitations make it difficult to implement in the workstation environment. In response to these limitations, board- and module-level products are starting to emerge that provide conversion from parallel HiPPI to serial fiberoptic format.

Broadband Communications is one of the leaders in this area, currently offering a box-level product and having just introduced a compact module. The box-level product, its Model 1200 fiberoptic HiPPI extender, receives standard parallel HiPPI signals and converts them to serial fiberoptic out-

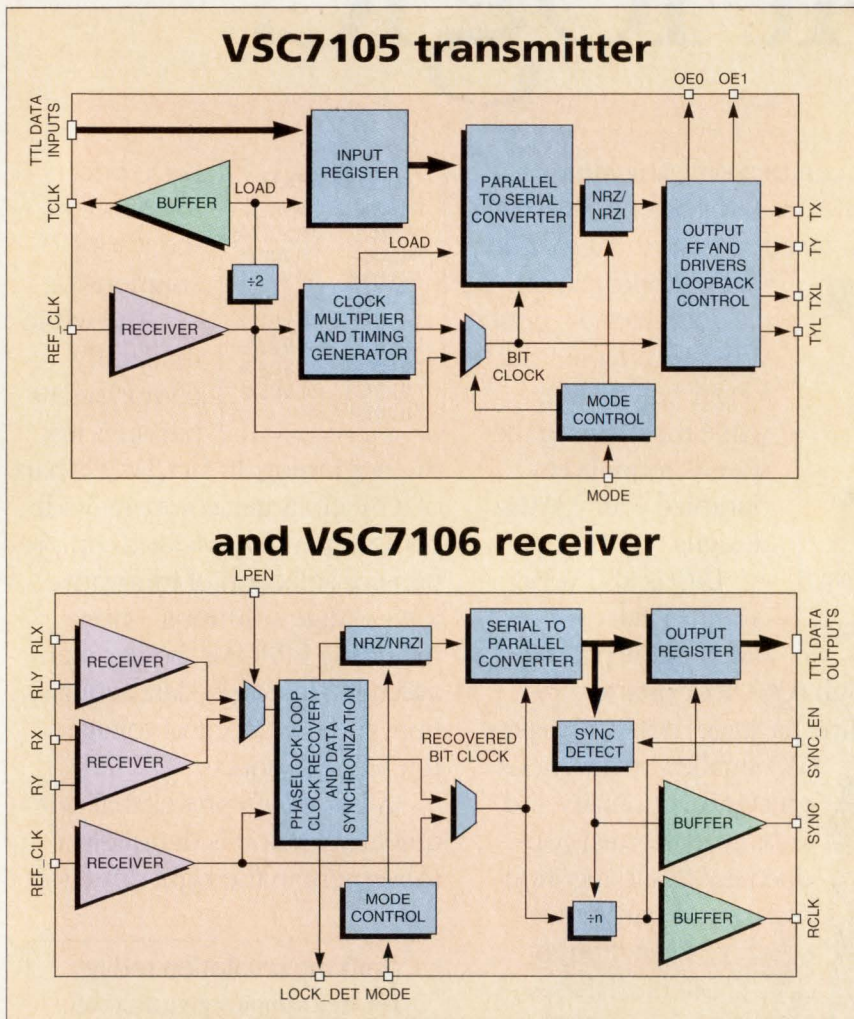

Vitesse is working with partners Interphase and Seagate on a new Fiber Channel system. Functional blocks of the transmit and receive nodes indicate the primary functions required for a Fiber Channel node.

high-performance board and module products. Chi Systems (Pleasanton, CA) was the first to implement a full HiPPI interface on VMEbus, and now offers 9U versions for Sun-based systems as well as a recently released 6U version. Chi's background is in software and hardware

standard VMEs, 80 Mbytes/s for VME64], it makes much more sense to connect HiPPI to the SBus than VME. This is particularly true in the Sun workstation arena, because Sun does not support a block transfer on VME and, therefore, the throughput is very slow." To handle

# CONTROL POINT

Test and Control Product News from Ziatech Corporation

Summer 1992



## CREDIT CARD SIZE I/O AND FIXED MEDIA ON STD BUS



A new STD 32 interface accepts two rugged, removable, business card sized PC Card™ modules.

Credit card sized memory and I/O devices that adhere to the PCMCIA standard can be plugged into any STD system via a new STD 32 interface, the ZT 8921. Compact, low-power modules called "PC Cards" can be conve-

niently installed and removed at any time, even during system operation.

### A ZIATECH FIRST

Ziatech, with its ZT 8921 PCMCIA 2.0 Interface, is the first

*continued* 4 ▶

For more information circle 100



## Low-Cost SBC Hosts Extensive Features

Ziatech's new ZT 8801 is a low-cost, STD Bus computer with a unique combination of I/O ideal for control applications. It provides a low-cost, very compatible alternative to Ziatech's V53-based processor card, the ZT 8901.

### V40 CPU, LOADS OF I/O

Its NEC V40 processor is code-compatible with the Intel 8088 CPU and features DMA support, an interrupt controller, three counter/timers, and a serial channel integrated with the core processor.

### SBX, RAM AND ROM

The serial channel onboard is configurable to RS-232 or RS-485 standards and is complemented onboard by up to 48 points of Opto 22-compatible digital I/O, an SBX connector, and up to 512 Kbytes of EPROM or Flash Memory, and up to 1 Mbyte of RAM.

*continued* 3 ▶

## INSIDE

- STARWindows DDE/Console
- NetBIOS in a Box
- New STD 32 Enclosures



## STAR SYSTEM Gains NETBIOS-

# NETBIOS® SIMPLIFIES INTERPROCESSOR AND NETWORK COMMUNICATION

New NetBIOS compatibility in the STD 32 STAR SYSTEM™ provides a standard software interface for communication between multiple processors in this STD 32 system. NetBIOS also allows STAR SYSTEM processors to easily communicate with other nodes in a local area network (LAN). Both of these new capabilities shorten the development time of multiprocessing applications requiring inter-processor communications, and make these applications portable to other NetBIOS-compliant systems.

### STD 32 STAR SYSTEM HOST

The STAR SYSTEM allows up to seven DOS-based processors to operate in a single enclosure, with equal access to system peripherals such as disk drives, video, and industrial interfaces. The STAR SYSTEM's NetBIOS approach complies with the STD 32 specification for interprocessor communication (IPC). The IPC also uses the NetBIOS standard.

### NETWORK IN A BOX

The availability of NetBIOS on the STAR SYSTEM brings standard network functionality to this unique multiprocessing system.

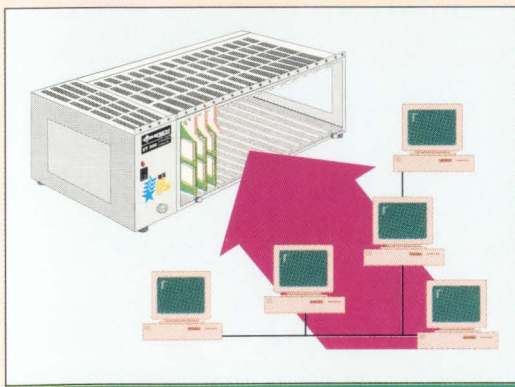

NetBIOS-compliant LANs can now be replaced by one STD 32 STAR SYSTEM.

NetBIOS carries out communication services on a network in the same way the BIOS in a desktop PC provides support for disks, terminals, and keyboards.

### REACH BEYOND THE STARS

With NetBIOS compatibility, each processor within a STAR SYSTEM "looks" like a network

### BRINGS NEW PRODUCTS TO THE STAR SYSTEM

A growing supply of control-oriented software programs, such as GENESIS (ICONICS, Foxborough, MA), GELLO (Event Technologies, Indianapolis, IN), and DOS NX (On-Line Systems, Kitchener, Ontario, Canada), are



NetBIOS software on the STD 32 STAR SYSTEM shortens development time.

node to other processors in the system. When a network card is installed in this STD 32 system, third party software running on STAR SYSTEM processors can use NetBIOS to communicate with processors on a LAN outside of the system. NetBIOS not only provides this transparent communication between the multiprocessing system and/or the LAN, but its standardized interface also simplifies the programmer's task.

NetBIOS-compatible, further streamlining the implementation of multiprocessing control applications on the STAR SYSTEM.

NetBIOS compatibility in the STAR SYSTEM lets users of NetBIOS-compliant LANs easily condense their application from several industrial or personal computers to a single multiprocessing STAR SYSTEM with minimal software reprogramming.

This NetBIOS capability is now supplied with all STD 32 STAR SYSTEMS at no extra charge.

*(Request a STAR SYSTEM data sheet on the Control Point return card.)*

# A Window to the Stars— STD 32 STAR SYSTEM™ DEVELOPS WINDOWS®

A new software option to Ziatech's STD 32 multiprocessing system provides a window for each processor on the system console, and allows processors to exchange data with Microsoft® Windows® DDE-compatible programs such as Microsoft Excel®.

## A STAR CAST

The STAR SYSTEM uniquely accommodates up to seven DOS-based processors in a single system, condensing the multiple PCs and peripheral sharing qualities of a LAN into a single, compact unit designed for real-time control applications. The STARWindows software option includes Microsoft Windows, STARWindows Console, and STARWindows DDE (Dynamic Data Exchange) Server.

## WINDOW WITH A VIEW

The STARWindows Console allows a window in the Microsoft Windows environment to serve as a console for each processor in the system.

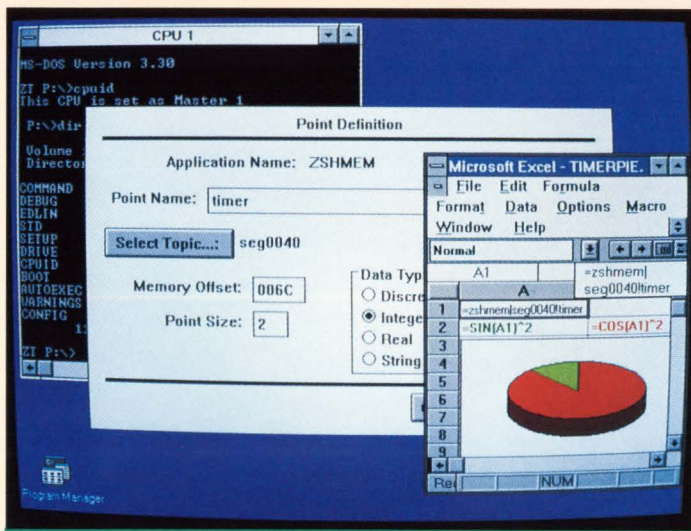

This screen shot of the STARWindows Console and DDE software shows CPU output in a window concurrent with interprocessor data exchange.



STARWindows Console supports popular development programs such as Microsoft QuickBASIC® and Borland's Turbo-Debugger®, making it an effective design tool for implementing real-time multiprocessing systems. This utility is equally helpful in the final target application, where it lets a single user interface "look" at multiprocessor activity.

## EXCHANGE SERVICE

STARWindows DDE Server incorporates the Windows DDE message passing protocol, allowing STAR SYSTEM processors to share data with other processors running Windows programs. The STARWindows DDE Server includes an interactive configuration utility that simplifies system configuration by defining data types and assigning shared memory addresses.

*(Request STARWindows info on the Control Point return card.)*

## Low-Cost SBC Hosts Extensive Features

*(continued from page 1)*

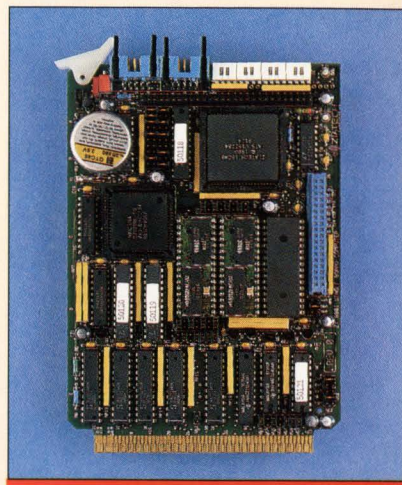

ZT 8801 Single Board V40 Computer offers many features.

## SOFTWARE SUPPORT

The new single board computer is supported by Ziatech's STD DOS and STD ROM software environments. Common I/O software support is provided by Ziatech's STD Device Driver Package (STD DDP).

The ZT 8801 is also available in a low power, extended temperature version (ZT 88CT01).

## FAMILY OF PROCESSORS

The ZT 8801 joins a large family of Ziatech processor choices ranging from low-cost products featuring the NEC V20 to high-end Intel processors.

*(Request a ZT 8801 data sheet on the Control Point return card.)*



# STD 32<sup>®</sup> BUILT TOUGH AND TINY

## New Enclosures Make Ruggedness More Accessible

The new ZT 250 and ZT 300 Industrial Computer Enclosures are designed for reliability in harsh environments.

### INDUSTRIAL TOUGH

By enclosing a low-noise STD 32 backplane, the ZT 250 and ZT 300 protect signal integrity and allow reliable operation during shock, vibration, and 0° to +70° Celsius temperatures. The corrosion-resistant steel card cage allows for efficient ventilation and cable routing while providing system-level protection from falling debris.

### UNIQUE I/O

The front panel on these enclosures hinges down for complete accessibility. Individual I/O plates, which make up the front panel, can be optionally equipped with connectors, signal conditioning boards, and cables for I/O.

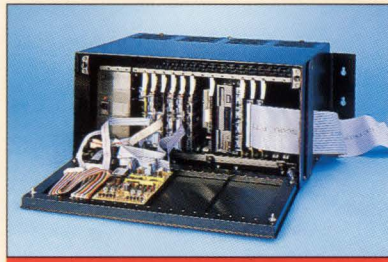

Both enclosures have hinged front panels for easy access.

### DIVERSE USES

The ZT 250 has a small footprint for 12" NEMA cabinet installation. It is convection cooled and can be panel, desk, or pedestal mounted.

The ZT 300 is 19" rack-mountable, has dual fans, and holds card cages of up to 24 slots.

*(Request ZT 250/ZT 300 data sheets on the Control Point return card.)*



## Credit Card Size I/O and Fixed Media *(continued from page 1)*

company to offer the "PC Card" standard on the STD Bus. The ZT 8921 features dual PC Card support, hardware and software resets, a 16 Kbyte PROM socket for BIOS extensions or other code, and support for multiple ZT 8921 interfaces in a single STD system.

The ZT 8921 comes with Microsoft's Flash File System Version 2.0 (FF2) device drivers.

### TOUGHEST ON THE BACKPLANE

PC Card-based memory and I/O installed in the ZT 8921 are resistant to shock, vibration, and temperature extremes that hamper standard peripherals in such environments.

### UNLIMITED ABILITIES

A variety of PC Cards exist for the ZT 8921. Flash, SRAM, ROM, OTP, and EEPROM memory cards, modems, and local area network interfaces are some of the PC Cards offered in this increasingly popular format.

*(Request a ZT 8921 data sheet on the Control Point return card.)*



The ZT 250 and ZT 300 offer 9- to 24-slot STD 32 backplanes, removable I/O plates, mounting options, and steel construction.

## CONTROL POINT

STD 32 is a registered trademark of Ziatech Corporation. STD 32 STAR SYSTEM and Control Point are trademarks of Ziatech Corporation. Other trademarks are held by their respective companies.



PHONE (805) 541-0488  
FAX (805) 541-5088

## The emergence of SCSI



**W**hat started in the early 1980s as a simple disk-drive interface has developed into an interface capable of interconnecting many different device types over a wide range of computer platforms. SCSI was born when Shugart Associates, a manufacturer of disk drives, designed a simple parallel I/O bus called the Shugart Associates System Interface (SASI). The company's goal was a low-cost interface for connecting disk drives to small computers.

In late 1981, SASI was turned over to the ANSI X3T9.2 Committee, and then it was renamed the Small Computer Systems Interface (SCSI). The SCSI-1 specification was completed in 1984 and finally approved and published in 1986.

### ■ SCSI-1 to SCSI-2

SCSI-1 had a number of limitations that SCSI device manufacturers addressed in various nonstandard ways. The X3T9.2 Committee soon started work on SCSI-2 to address these limitations. However, what was to be a quick effort to improve the SCSI command set and support devices other than disks turned into major enhancements to SCSI-1.

The changes to SCSI were many. Fast SCSI increased the data transfer rate to 10 Mbytes/s for 8-bit transfers and up to 40 Mbytes/s for 32-bit transfers. Bus arbitration was added to support multiple initiators. New commands, messages and command queuing were added to support other device types and aid in managing the SCSI bus. Members of the Committee worked on cabling, termination and connectors to make SCSI more reliable and easier to implement. SCSI-2 now supports disk, tape, CD-ROM, optical drives, printers, scanners, and other devices. In fact, not only are these devices supported in the SCSI-2 specification, but they can all coexist on the SCSI bus.

### ■ The SCSI connection

SCSI consists of two to eight devices connected to an I/O bus. Each device is either an initiator, a target or both. The initiator sends commands to a target to perform an action. A simple example is a computer (the initiator) sending a read

block command to a disk drive (the target). The drive responds by reading the area of the disk specified in the command descriptor block and transferring the data read back to the computer.

At a minimum, the SCSI bus needs one initiator and one target. It becomes more powerful as more devices are added. A typical configuration has one or more disk drives, a tape drive for backup and a CD-ROM drive. These are all target devices that connect through a SCSI host adapter (initiator) to the computer system. A more advanced configuration involves multiple host adapters sharing target devices.

The host adapter communicates with a target device by placing its SCSI ID along with the ID of the target on the bus. The target responds when it sees its ID and an I/O process begins. The initiator sends a command descriptor block plus any messages needed to handle the command. The target has the option of staying on the bus (staying connected to the initiator) and performing the requested command or breaking the connection (disconnect). A disk drive may disconnect when it needs to move read/write heads to a new area on the disk to read/write the requested data. Since this may take several milliseconds, disconnecting frees up the bus for other devices. At this point the initiator is free to send commands to other targets. When the target has its data ready, it reestablishes the connection with the initiator and sends the data. At the end of the operation the target sends status information to the initiator with the completion results.

### ■ The physical SCSI bus

The SCSI bus is a parallel bus consisting of nine control signals, eight data signals and one parity signal, along with termination power and ground signals.

SCSI-1 defined a 50-conductor cable that is also used in SCSI-2. SCSI-2 defines an additional 68-conductor B-cable that extends the data bus to 32 bits (from 8 bits) to increase the data transfer rate. A new cable configuration, called the P-cable, is a single 68-pin conductor cable that contains 16 data bits. This seems to be the configuration of choice because of its single-connector design, which easily fits on the current small SCSI disk drives. Unfortunately,

the P-cable wasn't introduced in time to become part of the SCSI-2 standard.

SCSI defines two types of electrical connections: single-ended and differential. Single-ended references each signal to a common ground and has a maximum length of 6 m. Differential uses two wires per signal, which improves noise immunity and extends the cable length to 25 m. Single-ended is used when all the connecting devices are within the same cabinet. Differential is used when devices extend to multiple cabinets.

Differential comes with some disadvantages. It consumes more power and requires more real estate on the printed circuit board. Additional board space is needed, because most SCSI protocol chips support single-ended internally but require external devices for the differential driver/receiver.

Every good bus must come to an end and SCSI has two of them. Terminators must be placed at each end of the SCSI bus to reduce signal reflections. SCSI-1 defined a simple 220/330- $\Omega$  passive terminator. SCSI-2 defines an active terminator that consumes less power and provides a better impedance match. Proper cabling and termination are vital to proper SCSI operation.

### ■ The future of SCSI

Adaptec and several other companies comprise the X3T9.2 Committee driving SCSI standards. Work on SCSI-2 is finished and the standard is out for public comments, a process that will conclude in July 1992. The Committee has already begun work on SCSI-3. The goal is to provide compatibility with SCSI-2 devices and to move the device-dependent intelligence out to the SCSI-3 devices.

SCSI-3 will support the current parallel I/O bus as well as define a new serial interface. Serial SCSI uses the same phases, commands and messages as SCSI-2, but this information is encoded and sent in the form of packets across the serial interface. While the Committee hasn't chosen the physical serial interface (Fiber Channel, P1394, or some other), "packetized" SCSI lets you send information faster and more reliably. In the end, SCSI-3 may define multiple serial interfaces which will extend the power of SCSI to more devices and over greater distances.

**Thomas Newman**, engineering manager, peripheral products operation, Adaptec, Milpitas, CA

## PERIPHERAL INTERFACES

put. The unit multiplexes data and control signals to a 1.1-Gbaud serial link; the signals are then demultiplexed and reconstructed at the receiving end.

"The interface," says Broadband's Toy, "is virtually transparent, but provides the capability to transmit at distances up to 15 km, as opposed

adds.

Felder believes that HiPPI's lifetime will be extended with fiber, and it will remain the preferred interface standard for at least the immediate future. Interestingly, the same factors that will make serial HiPPI less expensive and more widely used will also benefit

trol characters.

"For example," Nunn continues, "there's something known as an idle pattern which, when no data is being transmitted across the link, the link will automatically transmit so the receiving end knows that there is nothing coming across. In addition, there are other mechanisms for sending interrupt and error messages which had to be included in the chip set."

The Fiber Channel standard provides for uniform overhead and a common way for everyone to treat that overhead. Using the approach, different devices, such as a workstation and a disk drive, can talk to each other without either one knowing any more about the connection than the basic Fiber Channel rules.

"Similarly," continues Nunn, "HiPPI was defined only as a parallel, rather than a serial, interface." Because there are some differences in the way HiPPI and Fiber Channel manage information, there's currently no direct translation from parallel to serial HiPPI. "There is, however," says Nunn, "an ad hoc committee—a group of interested companies acting outside the ANSI body—attempting to define a serial HiPPI standard. This group has come up with its own overhead and encoding requirements."

### Either/or

"Our chip set will support serial HiPPI but it will require additional chips to conform to those standards—some kind of formatting logic," Nunn says. He explains that Vitesse developed its four-chip set so that the two high-speed devices could interface with a number of different encoder or multiplex/demultiplex chips. To create serial HiPPI, the basic transmitter and receiver can be mated to a discrete circuit or gate array mux/demux circuit. The mux and demux for the existing G-TAXIchip chip set are basically gate arrays with Fiber Channel protocols; they could be modified to handle HiPPI protocols.

"Looking into a crystal ball, I believe Fiber Channel will overcome serial HiPPI applications just because it's [Fiber Channel] supported as the standard communication protocol by ANSI," says Nunn. And because he believes this transition from HiPPI to Fiber Channel is imminent, he says Vitesse has no plans at this time to develop or market standard HiPPI protocol chips.

"There are a number of people that

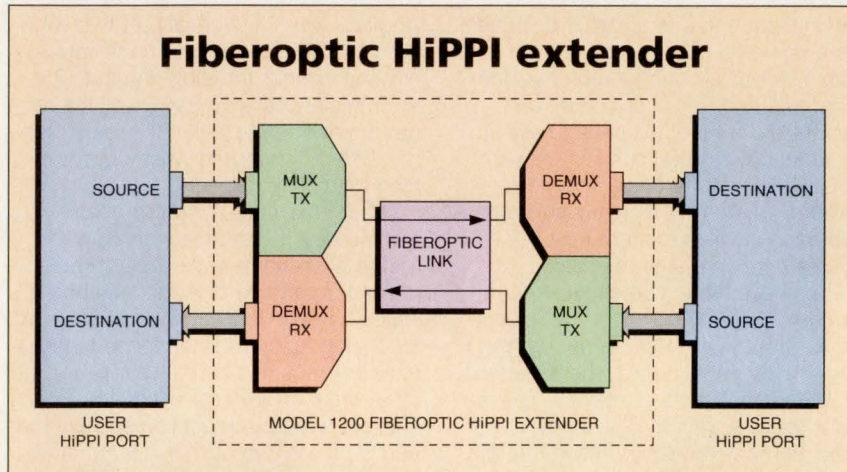

*Broadband Communications' current fiberoptic HiPPI extender comprises the multiplexing and demultiplexing blocks, which serialize the parallel HiPPI data and control signals and feed them to a fiberoptic transducer. In reverse, the signals are picked up off the cable, decoded and sent on to their destination.*

to the 25 m conventional HiPPI is restricted to." Combined with the reduced bulk and high reliability—the typical BER [bit error rate] is  $10^{-14}$ —of fiberoptic transmission, the approach provides many advantages. But the cost of such implementations isn't low. Broadband's HiPPI extender cost more than \$25,000.

But prices are coming down rapidly and the circuitry is becoming more compact. Adds Toy, "The features of the stand-alone HiPPI extender are now available in compact module format for incorporation by OEMs onto standard or custom board-level products."

### Life after HiPPI

Life after HiPPI seems to be thriving, and, in fact, Fiber Channel, another emerging ANSI standard (ANSI X3T9.3), is targeted to be compatible with—or a superset of—existing HiPPI. "HiPPI is here now and in use with a growing base of users," says Felder. Fiber Channel, because of its superior transfer rate (pegged at 1.0625 Gbits/s and above), will probably start to encroach on HiPPI sockets after the standard stabilizes. "But that's still at least two years away," Felder

Fiber Channel. These are a high-speed parallel-to-serial data link and fiberoptic transducers.

The most recent introduction providing a full Fiber Channel parallel-to-serial and serial-to-parallel interface comes from gallium arsenide specialist, Vitesse Semiconductor (Camarillo, CA). Called the G-TAXIchip, Vitesse's product is a GaAs version of a chip set developed a few years ago by Advanced Micro Devices (Sunnyvale, CA), which it called its TAXIchip. Vitesse's GaAs version is designed to operate at the 1.0625-Gbit/s rate of Fiber Channel, and can also operate at a rate of up to 1.25 Gbits/s in other proprietary schemes.

### TAXI?

"Originally the AMD TAXIchip chip set was targeted at only 100-Mbit/s rates for point-to-point communication and was not designed to address a particular protocol standard," says Bob Nunn, Vitesse marketing director. "When we designed the G-TAXIchip, we wanted to conform to the emerging Fiber Channel standard." This design includes a coding scheme for serializing parallel data and encode, as well as setting up a number of serial strings that are used as con-



# IN CLOCKING DEVICES TOO, YOU NEED A HIGH-SPEED APPROACH, PRECISE EDGE PLACEMENT AND MINIMAL SKEW.

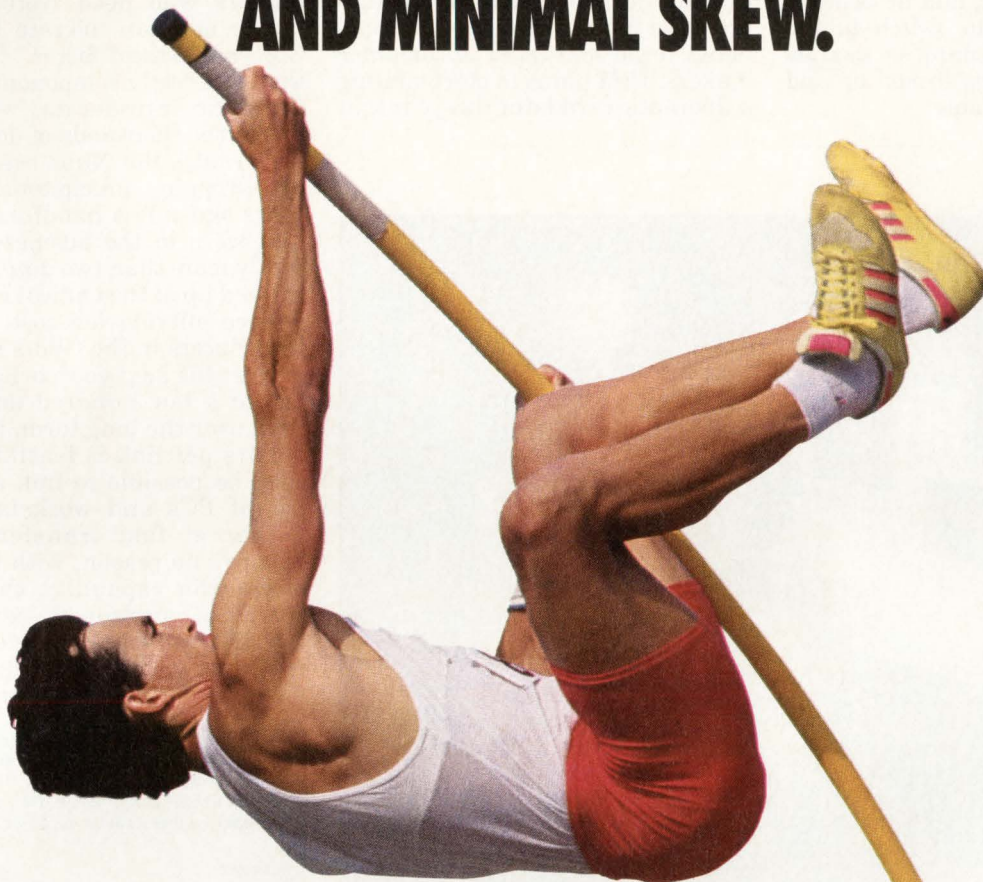

## BUT IT'S THE FLEXIBILITY OF OUR PRODUCTS THAT PUTS YOU OVER THE TOP.

For true configurability, TriQuint clocking devices lead the field. Start off with our versatile standard products that provide buffering, frequency doubling and user-selectable phase shifting. Then, vault to unrivaled flexibility with our GA1000. You can individually

configure each output clock by specifying frequency, pulse widths and placement of edges.

You get the performance advantages of TTL-compatible GaAs — with output frequencies to 160 MHz — along with a level of user-configurable flexibility that puts even your highest system requirements within easy reach.

Call us at (408) 982-0900 for full details today!

### SHIPPING IN VOLUME NOW!

	Input Frequencies	Output Configurations	Output Frequencies	Output Edge Placement
GA 1110E	20, 25, 33, 40 & 50 MHz	6 @ 1x	20 – 50 MHz	Fixed configurations
GA 1210E	20, 25, 33, 40 & 50 MHz	4 @ 2x, 2 @ 1x	40 – 100 MHz	Not applicable
GA 1000	20–80 MHz	6 individually configurable	20 – 160 MHz	Individually configurable



**TriQuint**   
SEMICONDUCTOR

## PERIPHERAL INTERFACES

have adopted HiPPI while they're waiting for the Fiber Channel specification to be completed," says Nunn. He says he's talked to many of these customers and potential customers, however, and he believes they fully intend to switch to the Fiber Channel standard as soon as the specification gets firmed up and parts become available.

Another team of companies has also jumped on the bandwagon to offer Fiber Channel technology. Hewlett-Packard (Palo Alto, CA) and IBM (Armonk, NY) announced a joint effort to develop and manufacture a family of fiberoptic components to be marketed to computer makers. IBM plans to start offering a fiberoptic card later this year that

complies with the FC-0 level of the ANSI standard.

According to Nunn, "Fiber Channel, like HiPPI, will get its first impetus from the supercomputer makers who need Gbit/s performance and can tolerate the price. Cost is a critical factor." Currently, the most costly components are the fiberoptic transducers, which now run in the thousands-of-dollars-per-node range. But Nunn sees that figure dropping precipitously. A few years ago only a handful of companies were in the business, but recently more than two dozen vendors showed up at the Optical Fiber Conference offering low-cost fiberoptic transducers in the Gbit/s range.

Over the next year, prices should fall to a few hundred dollars per link; over the long term, under ten dollars per link is feasible. It will then be possible to link any number of PCs and workstations together at fast transfer speeds. "There's no reason, with that kind of transfer capability, that a network of personal computers couldn't work as a single parallel machine with supercomputer performance," predicts Nunn. ■

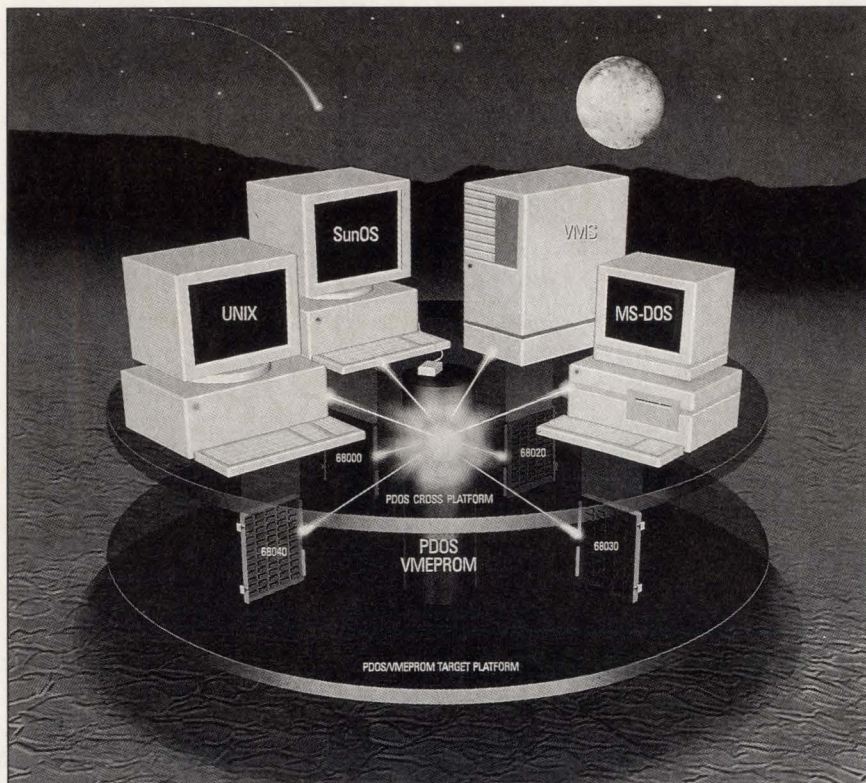

## Real-time with Flexibility, Portability, and Maintainability.

PDOS Full Spectrum Development gives you open platform flexibility. You can write real-time/embedded software on your favorite cross development system—and/or the target system.

Generated code is source and object compatible across all platforms. The code is completely portable between cross environments, across host and target platforms, and between the same or different target boards. You simply move the code to the new platform. It's that easy.

With proven PDOS performance and Full Spectrum flexibility, you get your product to market on time and within budget. Plus, with VMEPROM options, you have a future for upgrades and easy maintenance.

Set your product worlds apart from the competition, write or call for informative literature to help you get started. Act now and we'll also send you a free benchmark report on the performance of several real-time operating systems.

CALL 1-800-YES-PDOS **PDOS**

PDOS Puts Power in Your Products — For The Present and The Future.

EYRING CORPORATION, SYSTEMS SOFTWARE DIVISION, 1450 WEST 820 NORTH, PROVO, UTAH 84601 801-375-2434 FAX 801-377-3850 EMAIL: pdos-info@Eyring.COM  
GERMANY, AUSTRIA: Alimos Electronic GmbH, Martinsried, Germany, Tel: 089/857000-0 UNITED KINGDOM: Eyrisoft Ltd., Derby, England, Tel: 0332/384978  
BENELUX: Interay BV, Friesland, Holland, Tel: 05116/4052 JAPAN: Hi-System Control Corp., Tokyo, Japan, Tel: (03) 3201-0511

CIRCLE NO. 90

For more information about the technologies, products or companies mentioned in this article, call or circle the appropriate number on the Reader Inquiry Card.

<b>Adaptec</b>	
(408) 945-8600	Circle 370
<b>Advanced Micro Devices</b>	
(408) 732-2400	Circle 371
<b>Ampex Tape Systems</b>	
(408) 945-5600	Circle 372
<b>Broadband Communications</b>	
(407) 728-0487	Circle 373
<b>Chi Systems</b>	
(510) 463-2322	Circle 374
<b>Convex Computer</b>	
(214) 497-4000	Circle 375
<b>Cray Research</b>	
(719) 260-8282	Circle 376
<b>Digital Equipment Corporation</b>	
(508) 493-5111	Circle 377
<b>Hewlett Packard</b>	
(415) 857-1501	Circle 378
<b>IBM</b>	
(914) 288-3000	Circle 379
<b>IOTEK</b>	
(902) 420-0674	Circle 380
<b>Network Systems</b>	
(612) 424-4888	Circle 381
<b>Radstone Technology</b>	
(201) 391-2700	Circle 382
<b>Silicon Graphics</b>	
(408) 960-1980	Circle 383
<b>Sun Microsystems</b>	
(415) 336-4000	Circle 384
<b>Thinking Machines</b>	
(617) 876-1111	Circle 385
<b>Vitesse Semiconductor</b>	
(805) 388-3700	Circle 386
<b>Zitel</b>	
(408) 321-9600	Circle 387

# THE OEM POWER PLAY



The LBP-NX Laser Beam Printer Engine packs 17 page-per-minute printing power into a compact desktop unit. With its impressive throughput, high-volume paper capacity and acclaimed Canon reliability, the LBP-NX is the solid choice for OEMs who demand uncompromising, heavy-duty performance for their customers.

The LBP-NX features versatile two-tray paper handling, job offset for multiple users, and optional duplex capability to meet the demands of today's business. Plus Canon's ultra-

fine toner has a smaller particle size than conventional toners, producing exceptionally sharp text and graphics. Canon includes this new technology in the patented, user-replaceable EP-N cartridge which houses virtually all consumables.

Canon is seeking OEM partners with value-engineering and marketing insight. To see how Canon can give you a powerful edge, call 1-800-323-6766 and ask for the Canon OEM Laser Beam Printer Design Guide.



#### SPECIFICATIONS

<b>Print Speed:</b>	17 pages per minute
<b>Paper Handling:</b>	Letter, legal, A4, executive, envelope, OHP transparency, label stock Optional envelope feeder Optional duplex module
<b>Paper Delivery:</b>	Face up (50 sheets) Face down (500 sheets)
<b>EP-N Cartridge Yield:</b>	8,000 pages (at 5% coverage)
<b>Dimensions:</b>	17.9"W x 22.4"D x 19"H
<b>Weight:</b>	96.8 lbs.

© 1992 Canon U.S.A., Inc. Canon and the Canon logo are registered trademarks of Canon, Inc. Product specifications are subject to change without notice. The Engines that Drive the Industry is a trademark of Canon U.S.A., Inc. For more information, write Canon U.S.A., Inc., OEM Operations/Printer Division, One Canon Plaza, Lake Success, NY 11042.

The Engines that Drive the Industry™  
CIRCLE NO. 43

**Canon**



# Why send your engineers through the VME maze?

**MATRIX frees your engineers to do what they do best... solve application problems – not build VMEbus systems.**

Reduce your development risk and speed your time-to-market with an integrated VMEbus system from MATRIX Corporation. Since 1985, we have specialized in bringing the power of the VME open-architecture to integrated systems. Now you can start with a pre-configured system and add modules to create a fully integrated system ready for immediate application code development.

Your engineers are experts in their field of application. They can't afford to spend the time or resources to install and bring-up operating systems, de-bug software drivers, configure boards, make cables, and

resolve finger-pointing disputes between manufacturers. Let our investment in qualifying and integrating third-party hardware and software pay off for you. We offer:

**DATA ACQUISITION SYSTEMS:**  
2 GHz sampling front-end.

**DATA STORAGE SYSTEMS:**  
30 Mbytes/sec transfer rate.

**DATA ANALYSIS SYSTEMS:**  
Multiple array processors.

MATRIX Corporation provides a fully documented system, and post-sale support includes training, installation, telephone, and on-site support.

A basic system contains a development host, a target CPU, and an operating system. Add modules from the MATRIX full-line VME catalog, or from over 20 pre-qualified vendors, or specify your own modules.

MATRIX Corporation will deliver the system you need, on time, ready to develop application-specific code. Call us at **1-800-848-2330** to discuss your specific system requirement or to receive our full-line VME catalog.



1203 New Hope Road, Raleigh, NC 27610  
USA FAX (919) 231-8001

# Graphics ICs target Windows acceleration

*With GUIs such as Windows setting new standards, chip vendors are rethinking the most cost-effective way to speed up graphics. So instead of a few solutions, designers now have many.*

Dave Wilson  
Senior Editor

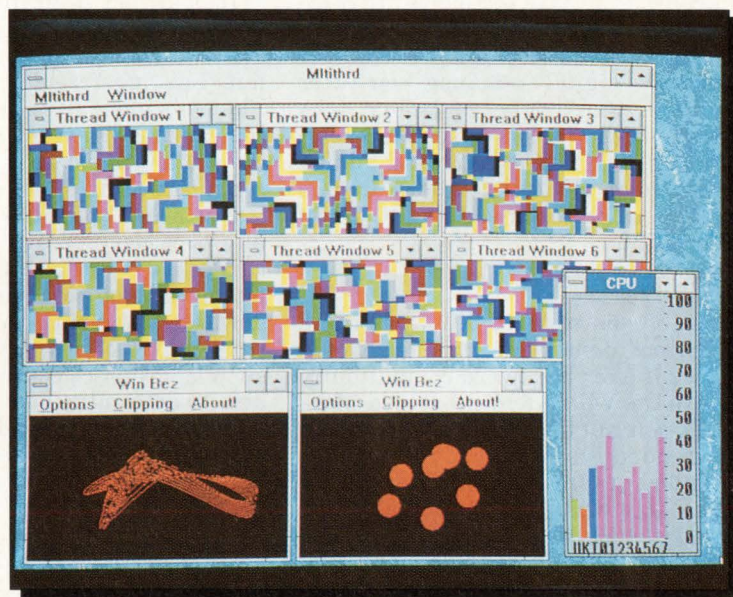

It's always been easy to figure out what's going on in personal computer graphics. IBM (White Plains, NY) set the standard and the rest of the world just followed. The hard part has been keeping up with the pace of change. In the past 10 years, there's been a plethora of graphics standards thrust on the unsuspecting PC designer. And although the changes may have benefited the user with higher performance and resolution, the real winners may have been those engineers gainfully employed writing software drivers to ensure that applications packages could keep up with newer computer graphics hardware.

In the PC world, a variety of alternatives exist for the designer wishing to build a PC graphics subsystem. And now, with the Windows graphical user interface (GUI) and its standard application programming interface (API) replacing the traditional hardware register-compatible models of EGA and VGA, the old way of maintaining PC compatibility by building register-compatible hardware may not cut the mustard for much longer. This trend will accelerate with the arrival of Windows NT and other advanced OSs. Graphics and even processor hardware compatibility will then become even less of an issue than it is today.

## Back to the future

After the introduction of the Hercules monochrome card in 1982, IBM announced its first color standard, the CGA, in 1983. It provided four colors in graphics mode with an on-screen resolution of  $320 \times 200$  pixels. In 1985, IBM introduced the EGA. Its  $640 \times 350$  matrix allowed 16 colors in graphics mode. In 1987, IBM developed what's now the current standard—VGA—and built it into the motherboard of the PS/2. It provides  $640 \times 480$  resolution with 16 colors on-screen.

Since then, a new standard has emerged, although this time IBM wasn't responsible for developing it. That standard, Super VGA, was developed, endorsed and adopted by a group of graphics companies and monitor vendors known as VESA (Video Electronic Standards Association). Super

*Windows NT runs several threads simultaneously on different CPUs. As shown here, one application has six threads running. Two sample applications are drawing Bezier curves.*

## GRAPHICS ICs

VGA represents a significant enhancement of the VGA standard, but there's no one resolution associated with it. In fact, there are many. The standard has gone from 800 × 600 to 1024 × 768, and now chips are available that will support 1280 × 1024 resolution.

For its part, IBM launched yet another standard in 1990—extended graphics adapter (XGA). To push the XGA as a standard, IBM licensed the XGA technology to SGS-Thomson (Phoenix, AZ), which currently offers two chips—a serializer palette digital-to-analog converter and an XGA display controller. XGA supports 256 colors at screen resolutions up to 1024 × 768, and adds a new color mode that allows 65,536 colors to be displayed at 640 × 480 resolution.

### Inside XGA

As the son of VGA, XGA has three distinct modes of operation. Not only does it offer backward compatibility with the VGA standard, it also offers 132-column text mode as well as an extended graphics mode. In the extended graphics mode, XGA devices can accelerate and improve screen updates by the use of an autonomous graphics processor that's used to handle custom line drawing, area fill, pixel block transfer, scissoring, and map masking. The coprocessor works on pixels within pixel maps,

and the XGA standard allows pixel maps of any arbitrary size up to 4096 × 4096.

XGA also supports some useful features of modern GUIs. Map masking is an important characteristic of XGA that lets you draw only in the exposed area of a window, rather than the whole window. Fast text drawing, crucial to windowing environments, is supported through an on-chip block-transfer function.

In addition to graphics features, XGA has also addressed some concerns of the system designer. It offers bus mastership, for example. That lets video data move from system memory to video display memory without the main system processor intervening.

But are all of these functions really necessary? While XGA has the capability to perform local bus mastering, it's not exercised in the Windows environment. Worse yet, at the present time bus master devices such as graphics controllers are unable to determine how the processor virtualizes physical addresses. And because today's systems are not truly multithreaded, even if a graphics controller can perform bus mastering operations, under present operating systems, it's difficult to do independently of the CPU.

The other "gotcha" is that the CPU, under the direction of the operating system, may be able to

transfer data just as fast as a mastering graphics controller could. "In short, [bus mastering] doesn't buy designers that much today," says Larry Vandendriessche, director of graphics products at NCR (Colorado Springs, CO). "In the graphics world, there's almost nothing it can do, especially in Windows. In OS/2 it has a minor capability. It's a fairly expensive piece of hardware. It's not like a disk drive application, where there's a need to perform some serious transfers back and forth from memory to disk."

### Who needs XGA hardware?

Most people believe XGA will take over from the VGA market at a modest pace, limited by developments in Windows NT and OS/2 Version 2.0. If these OS alternatives aren't quickly forthcoming, however, XGA might gain ground at a faster pace. In that case, XGA may have a limited market share as graphics designs continue to become more fractured and as the importance of the OS and GUI come into play.

Vandendriessche thinks that XGA as a register-level standard isn't all that necessary. "Ninety percent of the applications programs are Windows-based, not XGA-based. With the popularity of Windows, the Windows API is the one that everyone writes to," he says. "By using emulation techniques, hardware that

doesn't look exactly like XGA can take the commands that are written by an XGA software driver and display them. We can get a better price/performance by using a slightly different architecture. It's very possible to write an XGA emulator [a program that will look like XGA to applications] and with it make the non-XGA-compatible register hardware much faster than XGA. That's even with an emulation step in between. It will still be compatible with XGA, but it's typically at the driver level and not at the register level."

But there are still those who value

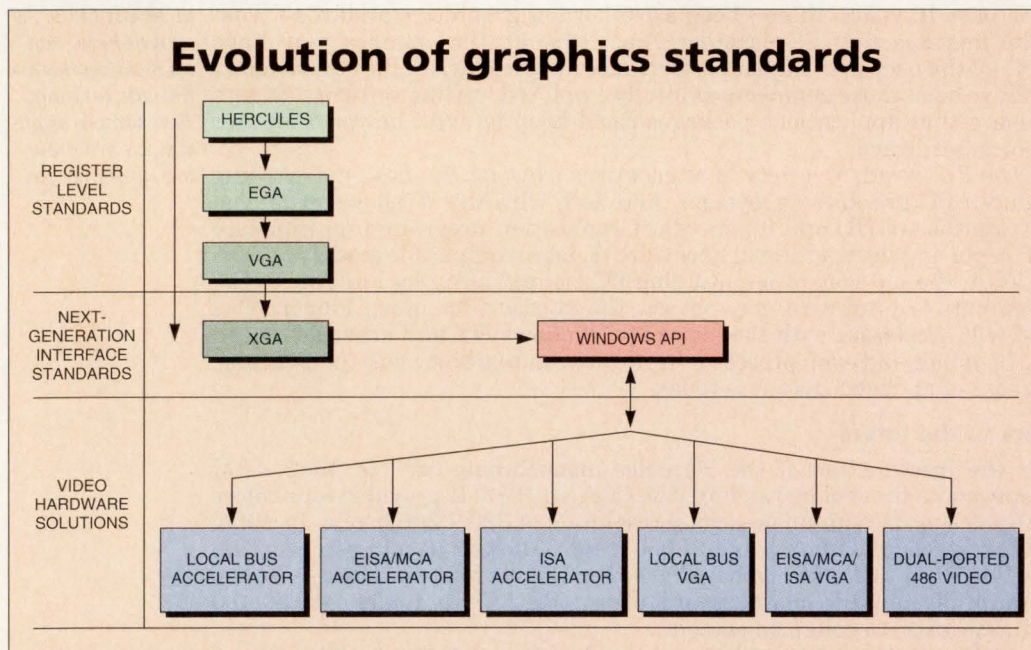

The evolution of graphics standards from hardware to software has opened up a variety of hardware processor solutions. These range from add-on local bus accelerators to full-fledged add-in AT and EISA processors. The solution that's optimal depends on the architecture of the machine.

# Think Packaging.



## Think Mitsubishi Gate Arrays.

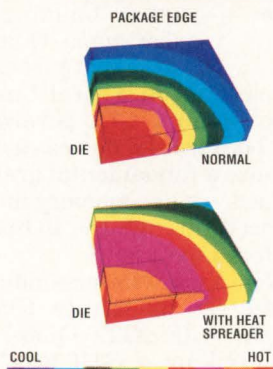

Whether it's your next gate array design, or your first, you've got to think about packaging. Your very next thought should be: **Mitsubishi Gate Arrays.**

We offer the packaging solutions for fast, compact and gate-intensive systems.

For example, our exclusive  $\mu$  Pitch TAB™ packaging, with its ultra-fine 0.25mm lead pitch, gives you pin-counts as high as 576.

Mitsubishi also offers power-cooling packages for higher reliability in fast, gate-intensive arrays. Available in both  $\mu$  Pitch TAB and QFP, power packaging features an aluminum heat spreader that transfers heat from the die across the entire package. The result is a much cooler die and higher reliability. We also give you over 100 packaging options, including plastic and ceramic QFPs and PGAs.

**VISION**®  
**ACTION**  
**REALITY**

Mitsubishi's 0.8 $\mu$ m arrays give you the highest gate count (400,000 gates) and lowest power dissipation (2.4 $\mu$ W/MHz/gate) you can get.

We also offer design kits for the industry's most popular workstations, from logic synthesis, to simulation, to automatic test pattern generation (ATPG). So you can design on your own workstation or ours.

We're one of the world's top 10 semiconductor suppliers, and we've been in the ASIC business for over 15 years. As a result, you can depend on local design support and the global resources of a stable, well-capitalized company.

When you think gate arrays, think packaging. Then think Mitsubishi. You'll be glad you did.  
Phone (408) 730-5900, ext. 2106.

 **MITSUBISHI**  
ELECTRONIC DEVICE GROUP

## GRAPHICS ICs

XGA. "XGA not only offers Windows performance but is a standard graphics reference for people who don't want to work in the Windows environment," argues Nunzio Martelli, technical marketing manager of SGS-Thomson (San Jose, CA). "And that's important for some software developers who want to write directly to graphics chips at the XGA register level, perhaps in addition to a software interface API like the one Windows provides." Martelli also feels that IBM is opening up XGA to make it a standard and hypothesizes that by the end of the year more than one chip company will be offering XGA chips.

Perhaps Martelli has a point. But despite IBM's efforts to stop it, no one doubts that Microsoft (Redmond, WA) has beaten IBM's OS/2 to the punch with its Windows operating environment. Microsoft Windows 3.1 is presently being bundled by several leading PC vendors while OS/2, it seems, has been left on the shelf, despite user claims of superior robustness and performance.

### Windows opens options

Microsoft Windows is divided into three parts: the graphical device interface (GDI) that supervises all interaction between the application and output devices, such as a monitor or a printer; the user interface that supervises interaction between the user and input devices; and the kernel that manages memory. Windows drivers, loaded at start-up, communicate directly to the GDI, informing it of specific functions that specialized hardware might offload from the CPU. This lets existing systems and software take advantage of new hardware without further modifications.

Although the graphics marketplace might already seem gloriously fragmented, Windows will make it more so, at least according to Michael Maia, vice-president of sales and marketing at Trident Microsystems (Mountain View, CA). Maia expects to see several key areas emerge in the

next few years: graphics coprocessors, local bus interface graphics chips, high- and low-resolution VGA graphics chips, and, perhaps most important, GUI accelerators. Because of the sluggishness of Windows applications, many new graphics accelerator architectures have emerged just to accelerate Windows.

Martin Booth, senior product

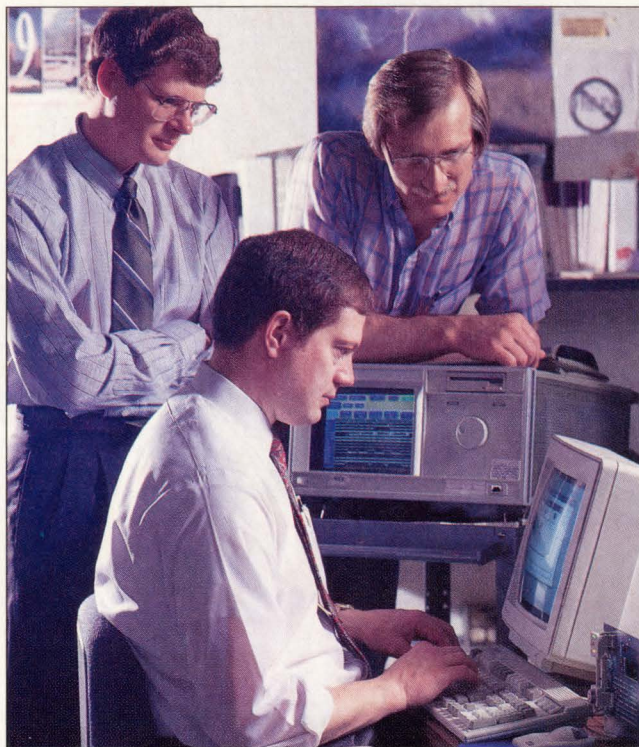

Larry Vandendriessche (seated), director of graphics products at NCR, thinks that register-level compatibility with XGA is unnecessary. Emulation techniques will give better performance at a lower price, he argues.

marketing engineer at Fujitsu Microelectronics (San Jose, CA), notes that the ubiquity of Microsoft Windows has freed PC designers from becoming register-level-compatible with IBM. On the down side, 50 to 80 percent of a CPU's execution cycles are consumed just by running the subroutines of Windows. This, of course, results in a reduction in application performance when compared to DOS applications. Booth says that bitblt and line drawing are the two primary functions used by Windows to represent text and graphics information on screen. Accelerating those functions accelerates Windows applications, then.

### A master at going faster

While IBM has established some sort of direction with XGA, many

vendors, such as Weitek (Sunnyvale, CA), agree with NCR that many features of the XGA architecture, such as memory management and bus mastering capabilities, are unnecessary for mainstream office-automation applications. These vendors argue that it's possible to produce more cost-effective solutions by designing devices whose sole aim is to process bitblt and line drawing functions—a solution, in fact, that sits somewhere between using the host processor for the function and offloading it to a dedicated engine such as an XGA, 8514A or Texas Instruments TMS340X0.

Representative of this philosophy is the Weitek W5086, a device that the company claims will increase the speed of Windows bitblt functions by over 26x when compared to simply using the system CPU for the purpose. Bitblt and line draw are targeted as the two primary operations for improvement.

Henry Quan, director of marketing at graphics chip and board vendor ATI (Scarborough, Ontario), feels that, when comparing accelerators, the comparison shouldn't just be based on the speed of acceleration functions such as bitblt at the expense of ignoring architectural issues in building graphics subsystems. Quan goes on to say that just putting an

accelerator on a local bus will not help improve GUI performance at all, because the device itself doesn't remove a fundamental graphics bottleneck—video memory must be addressed through the I/O port of the system processor.

Ron Yara, vice-president of marketing at S3 (Santa Clara, CA), agrees with ATI's Quan. He says that linking a GUI accelerator to display memory over a high-speed local bus interface eliminates the graphics performance bottleneck present in systems that require that the CPU pass through an I/O bus and then the display controller before reaching display memory and executing a graphic function. In the ATI graphics architecture, graphics data avoids going through the I/O port of the 486 when it needs to be



## Printer graphics mirror those of CRTs



**T**he move from text-based user interfaces to high-resolution graphical user interfaces is creating graphics demands that host CPUs can't efficiently handle. At the same time, the move to high-resolution color and gray-scale laser printers working at 600 dots per inch (DPI) or better is outstripping the graphics capabilities of today's laser printer controllers. In both cases, the industry is moving to graphics coprocessors that can offload the host CPU and printer controller of compute-intensive functions such as graphic rendering.

The processes of producing images for CRT display and laser printer output are quite similar. In the case of CRT output, the host CPU generates a high-level description of the image (in Graphical Device Interface for Windows and QuickDraw for Apple machines), executes the display list and writes the pixels to video memory. In the case of laser printer output, the host CPU sends the page description (in PostScript or PCL5) to the laser printer controller, which interprets the page description, executes the display list and writes the resulting image to laser printer memory.

### ■ Controllers carry the burden

Because laser printer controllers must produce much higher-resolution images—300 DPI for an HP Laserjet III versus 96 DPI for a 1024 × 768 Super VGA display—they often bear a much higher computational and graphics burden than CRT controllers. The move to 600-DPI resolution in laser printers will increase this burden by a factor of four to five, with the addition of gray-scale and color capabilities upping the ante even more.

At 300 DPI, graphics operations such as executing the display list and rendering images consume only about 20 per-

cent of the controller's cycles. As a result, the controllers in 300-DPI printers are able to get by with RISC processors such as Intel's i960, or CISC processors such as the 68020 working in conjunction with a dedicated bitblt (bit boundary block transfer) processor.

At 600 DPI, however, the graphics load increases substantially, occupying 35 to 80 percent of the controller's time. To keep up with graphics operations that have real-time requirements, such as building characters to put in the font cache, the controller must steal cycles that would normally be used for page interpretation. As a result, printing speed suffers.

### ■ Offloading responsibilities

One way to offload the printer controller of its graphics responsibilities is to use a dedicated graphics acceleration coprocessor such as Peerless' banding coprocessor. As in CRT graphics, relatively few operations, such as bitblt and fill, account for the bulk of the graphics load. By accelerating these operations, a graphics coprocessor can provide a dramatic increase in graphics throughput.

Bitblt, for example, can be greatly accelerated by working on several aspects of the bitblt operation, such as calculating and applying masks, moving bit fields and aligning source and destination addresses in parallel. Anticipating common sequences of operations can also yield a significant speedup. For example, when setting up halftone patterns, the coprocessor should also set up to perform three-operand bitblts, which will be needed to apply the halftone patterns to characters.

In addition to improving drawing speed, a graphics coprocessor can greatly reduce laser printer memory requirements and cost by using image banding techniques. Depending on the resolution, banding can provide a saving of two to eight times the memory used by full-page buffered designs, which

must provide a separate memory location for each pixel on the page.

### ■ Limited technology

But lack of efficient storage representations, innovative algorithms and controller horsepower has limited the use of banding technology. To band an image in real time, the controller must be able to execute the display list and output the image fast enough to keep up with the drum. At 8 pages per minute, the controller must be able to convert a PostScript page description to a 1-Mbyte image every 7.5 s. A 25-MHz i960, by contrast, requires 15 to 18 s to perform this conversion for a Ventura Scoop image.

Many 300-DPI PCL5 laser printers, such as the HP Laserjet III, exploit banding but are limited to simple graphics. When you try to output complex images, the printer controller loses its ability to band the image in real time. To print such images, you must buy additional memory, which defeats the purpose of using banding.

To make banding feasible, Peerless has developed a compression technique that lets interpreted page descriptions be more efficiently represented and executed. For even higher resolution (greater than 600 DPI), Peerless has added a hardware banding capability that lets its coprocessor band images in 500 to 600 ms, independent of resolution. At 1200 × 600 DPI, for example, a printer based on Peerless' coprocessor and using the PostScript language requires only 2 Mbytes of memory, compared to 16 Mbytes for designs that use full-page buffering.

Because the graphics requirements of laser printers and CRTs are so similar, manufacturers are looking for opportunities to use coprocessors for both display and printing applications. Such a coprocessor could even serve double duty, providing graphics acceleration for both display and printing.

**Steve Butterfield**, vice-president of hardware development, Peerless, Redondo Beach, CA

written to the video memory from the system RAM. Instead, high-speed data can stream into video memory under control of the 486 and the bus interface controller on the ATI graphics chip.

Quan adds that the problem with

some accelerators is that they can't access video memory alone. A graphics engine must be set up to read the pixel data back through the I/O port of the system processor. That approach, he argues, is very inefficient. "The way to overcome it is to

combine the best of both worlds—use VGA for compatibility to boot the system, and after that use the accelerator to boost the performance of the graphics," Quan says. Similarly, S3's S86C911 GUI accelerator performs linear addressing, letting

## GRAPHICS ICs

the part gain direct access to memory.

### Say no to coprocessors?

For its part, the Texas Instruments Graphics Architecture (TIGA) has represented one of the more cost-effective means to obtain high-performance, high-resolution graphics on the PC/AT bus. Certainly, it looks as though TIGA hasn't been forgotten by Microsoft. The recently released Windows Version 3.1 includes a

boards are now under \$500 and TMS34020 boards are falling below the \$1,000 mark.

Despite these facts, not everyone paints the same kind of graphical success story for its coprocessors that TI does. Some, such as NCR's Vandendriessche, see a trend away from graphics coprocessors altogether. As an example, he cites Dell Computer's (Austin, TX) 486 PC demonstrated at Comdex, which had no graphics processor chip.

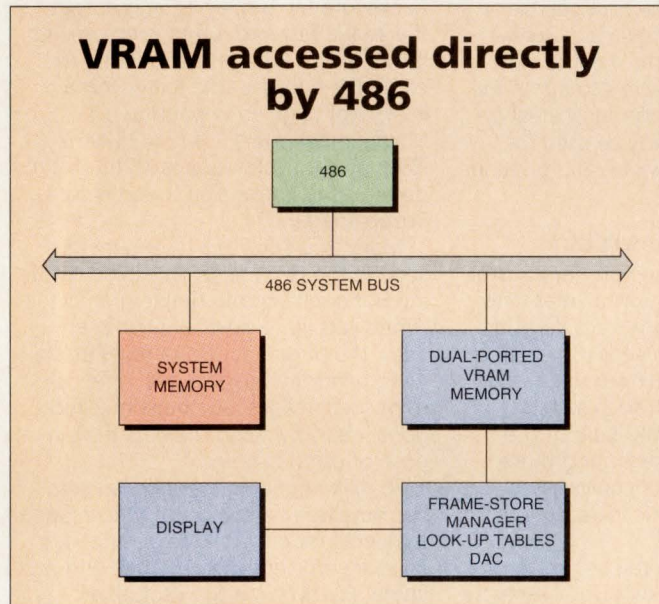

*The power of the 486 may be unleashed to handle graphic functions and be every bit as fast as a dedicated graphics accelerator—if the memory architecture is built correctly. Dell Computer has demonstrated a fast PC graphics system working with dual-ported video memory and Inmos color video controllers.*

TIGA driver, giving users the ability to accelerate Windows applications at higher resolutions. In fact, of the selected group of drivers included in the latest version of Windows 3.1, Texas Instruments (Dallas, TX) claims that the TIGA driver is the only one capable of resolutions of  $1280 \times 1024$  and beyond.

The TIGA driver is optimized to let new features in Windows 3.1 take advantage of TI's 340X0 family of processors that are at the heart of the TIGA architecture. For example, the driver lets the TrueType scalable font technology in Windows 3.1 tap the font-caching capabilities of the TIGA-340 processors. "With the capability to take Windows 3.1 into the future with support for true-color images and support for resolutions beyond  $4096 \times 4096$ , it's easy to see why we supported TIGA as the highest-resolution driver in the 3.1 package," says Rich Tong, Windows product manager at Microsoft. Nevertheless, solutions still aren't all that inexpensive. Some TMS34010

In the Dell design, a central 486 processor performs graphics drawing operations as well as general-purpose applications. On the motherboard, high-bandwidth, dual-ported video memory appears to the host processor just like system memory. In other words, the host processor has direct access to video memory as well as its own program memory. The other port of the video RAM, the serial shift port, is hooked to an Inmos triple 8-bit D-A converters as well as a look-up table that's used to convert and display the VRAM data.

"The result is that the 486 is several times faster at graphics than some 'accelerator' chips, and noticeably faster than a Sun workstation," says Vandendriessche. Naturally, the Dell machine is not "truly" register-set-compatible with VGA, but the fundamental principle that a 486 can be used in such a fashion, Vandendriessche feels, is a strong argument against coprocessors.

Yet another factor limiting the appeal of graphics coprocessors is their

price. For the cost of a high-end graphics card (\$1,000 or so), PC users can move up a generation in CPU. You can purchase the next generation of 486 for \$1,000 more. That creates a lot of backward price pressure on intelligent graphics cards. On the other hand, PC designs that support tightly coupled processor/video sections such as Dell's let you capitalize on the power of the processor not only for video processing but also for all other non-video-related processing too.

That's why most VGA suppliers, such as NCR and AT&T (Allentown, PA), are moving to architectures where the graphics chip will reside on a 486 or 586 local bus, letting the video chip perform only those functions that the processor doesn't do well. Color expansion, as well as line and curve drawing, for example, require more registers than are locally available in a standard X86 architecture. These are likely to remain areas where acceleration can be performed at a tolerable price to the end user.

### Going direct to the CPU

In addition to hardware-based bitblt support and hardware cursors, many of the newer VGA designs sport a direct interface to the on-board processor as well. As for any standards associated with that interface, that's a horse of a different color. "Currently, there is no standard for the local bus," says Steve Gary, director of marketing for video imaging and graphics at Oak Technology, a VGA chip company based in Sunnyvale, CA. When Gary describes his chip as compatible with a local bus, the bus is defined as the one that's used to communicate between the cache controller, CPU and memory.

There is, however, a VESA standards committee working on defining a local bus. It's currently at the draft level. For its part, Intel (Santa Clara, CA) has proposed another standard—the PCI (peripheral component interconnect). Recently, Intel has offered its proposal to the local bus standards committee for consideration.

NCR's Vandendriessche agrees that there are many definitions of a local bus at the moment. "We see most people putting the VGA chip directly on the processor bus or a local bus such as Opti, which is like using the processor bus plus or minus one signal," he says. He feels

# LAST SEPTEMBER, 85 MILLION PEOPLE DESPERATELY WANTED A DEMONSTRATION OF OUR FINEST LOGIC ANALYZER.



Only one logic analyzer could have brought the most crippling communications failure in U.S. history to a swift conclusion.

The new DAS/SE from Tektronix. With 200 MHz synchronous clocking, thousands of cycles of memory depth, and literally hundreds of channels, the DAS/SE is without question the fastest and most powerful logic analyzer around. And with 11



different stimulus & acquisition modules, it can be configured to solve any of your digital debug problems. For a personal demonstration, call Tektronix today and ask about the DAS/SE. The logic

analyzer that could very well prevent another banner year. **TALK TO TEK/1-800-426-2200 EXT. 73**

**Tektronix**  
Test and Measurement

## GRAPHICS ICs

that actual processor bus architectures, such as Intel's PCI, are a little farther down the road, and really only make sense when you have more than just the VGA chip sitting on the local bus. He describes the two camps as processor-direct—where the bus actually talks to the processor—and those that rely on newer interfaces such as Intel's PCI.

For their part, motherboard manufacturers are moving toward a modular architecture where a single board design can be used in a variety of market segments. Some current

machine, the processors may be more capable of performing the graphics operations than the limited graphics hardware that can be built into a dedicated graphics controller."

### Add processors for more speed

That's not to say that there's no demand for coprocessors at all. Even Vandendriessche admits that a coprocessor solution based on an AT add-in card can still make a lot of sense. And, at present, the largest opportunity for graphics coprocessor chip vendors is still on expansion

chines by simply adding another general-purpose X86 processor directly onto the motherboard.

That approach may sound the death knell for the graphics processor. If the user wants to upgrade the video, this can be done by plugging another X86 processor into an open slot on the motherboard. "For the price of a graphics processor, users will purchase another 486 to accelerate all their applications—not just the graphics element. It's a move away from specialized processing to general-capability processing which is shared by a range of tasks," says NCR's Vandendriessche.

As for graphics, it may be the greenback alone that determines the success of one graphics solution over another. "The PC world is a cutthroat business," says Surinder Rai, AT&T's manager of product definition and applications. "After all, most of the graphics solutions are attempting to do the same thing—speed up Windows." ■

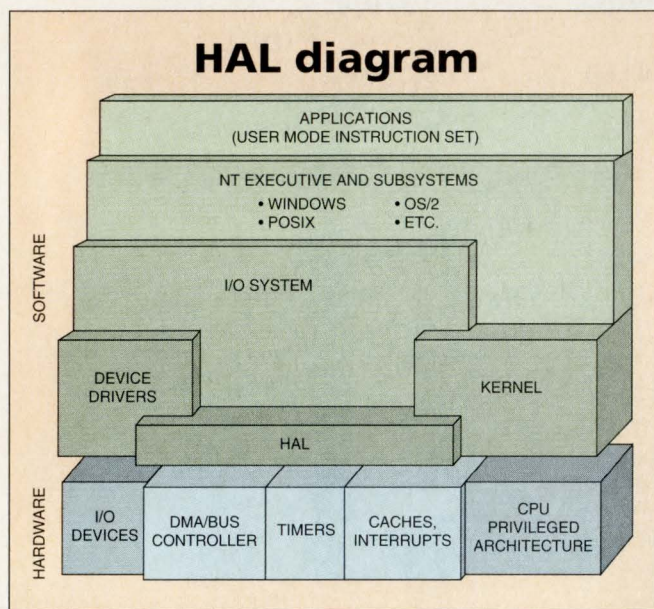

*The world according to Gates—Windows NT removes the intricacies of the hardware from the developer of the software application, letting you make changes in hardware without hurting application compatibility. This is achieved through the hardware abstraction layer (HAL) that isolates the OS from the specifics of the hardware.*

PC chip sets let you build motherboards that sport EISA-like connectors bringing out the signals of the microprocessor to the end user. In that way, if you wish to upgrade a system to a 486 processor, it's only necessary to purchase an add-in processor card to slip into that slot. With such a backplane approach, you could upgrade processors or add an upgraded local bus graphics card simply by adding a new card.

Placing a frame buffer controller onto a local bus is extremely efficient—an order of magnitude increase in performance can be achieved without going to the added expense of going to a programmable solution. "Part of the reason that the local bus will be used in conjunction with the frame buffer approach is that the processor itself is becoming more powerful," says Oak's Gary. "With a 286, you didn't want to burden it with the heavy computation required for graphics operations. With the 486- or an R3000-based

boards like AT adapter cards. In those cases, applications can benefit from the autonomous operation of the video chip—performance can be improved by using a graphics coprocessor connected to the host across a slow bus such as ISA.

There's also no reason why today's current generation of VGA devices can't address the requirements of the AT add-in market as well as those of the market for local buses. Vandendriessche argues, however, that when designers have the option of building graphics devices directly onto a local bus and running at the speed of a 486, then a coprocessor on an AT bus can't match the performance.

Undoubtedly, Windows NT and OS/2 Version 2.0 will change the face of PC and PC graphics design forever. As multitasking, multithreaded operating systems, they'll let hardware designers build modular PCs that will permit end users to extend the processing power of their ma-

*For more information about the technologies, products or companies mentioned in this article, call or circle the appropriate number on the Reader Inquiry Card.*

<b>AT&amp;T</b> (800) 372-2447	Circle 214
<b>ATI Technologies</b> (416) 756-0718	Circle 215
<b>Dell Computer</b> (512) 338-4400	Circle 216
<b>Fujitsu Microelectronics</b> (408) 922-9000	Circle 217
<b>IBM</b> (914) 288-3000	Circle 218
<b>Intel</b> (800) 548-4725	Circle 219
<b>Microsoft</b> (206) 936-8080	Circle 220
<b>NCR</b> (719) 596-5795	Circle 221
<b>Oak Technology</b> (408) 737-0888	Circle 222
<b>Peerless</b> (310) 536-0908	Circle 223
<b>S3</b> (408) 986-8144	Circle 224
<b>SGS-Thomson</b> (602) 867-6100	Circle 225
<b>Texas Instruments</b> (800) 336-5236 ext.700	Circle 226
<b>Trident Microsystems</b> (415) 691-9211	Circle 227
<b>Weitek</b> (408) 738-8400	Circle 228

# EUROCOM<sup>®</sup>16

The low cost solution ...  
... for any kind of CPU/Graphics application on VME

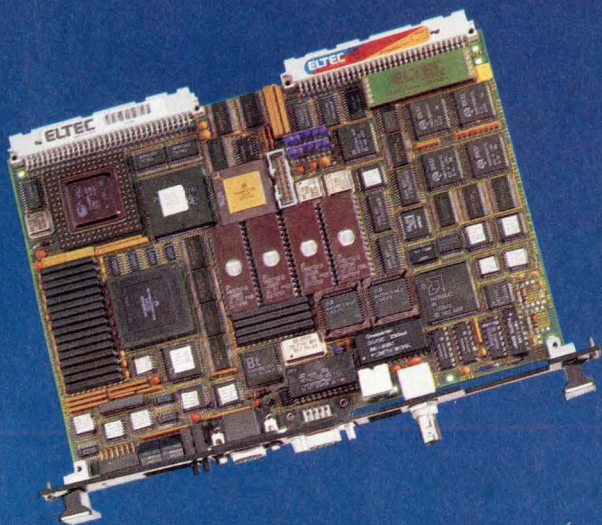

## Multi-Functional Features

68(EC)030, 25 MHz CPU, optional FPU, SVGA-Graphics (800 x 600 pixels) with 16 colors, support for EL-displays, Ethernet or Cheapernet Interfaces, SCSI Interface, 4 or 8 MByte DRAM, 128 KByte SRAM, 2 MByte EPROM space, AT-Keyboard and mouse adaptor, 4 serial and 2 parallel ports.

## Software-Flexibility

Realtime Operating support for OS-9 and LynxOS including X-Window and MGRplus TCP/IP network software.

## Modular Design

Board design permits low cost specific configurations for quantity requirements by removing various features.

... Want to know more about this or any of ELTEC's other VME CPU, Graphics or Image Processing products then call or fax us now ...



**ELTEC - The complete VME solution.**

American  
**ELTEC**

USA: American ELTEC, Inc. • 4340 Stevens Creek Blvd. • Suite 204 • San Jose, CA 95129 • Tel (408) 244-4700 • Fax (408) 244-5544  
U.K.: ELTEC International PLC • 45 Caldecotte Lake Drive • Caldecotte Business Park • Milton Keynes • MK7 8LF • Tel (0908) 36 64 99 • Fax (0908) 27 46 00  
France: ELTEC International SARL • 1, Allée des Garays • 91120 Palaiseau • Tel (1) 64 47 18 77 • Fax (1) 64 47 09 33  
Germany: ELTEC Elektronik GmbH • Galileo-Galilei-Straße 11 • 6500 Mainz 42 • Tel. (061 31) 918-0 • Fax (061 31) 9181 98

CIRCLE NO. 47

# Before you get too far

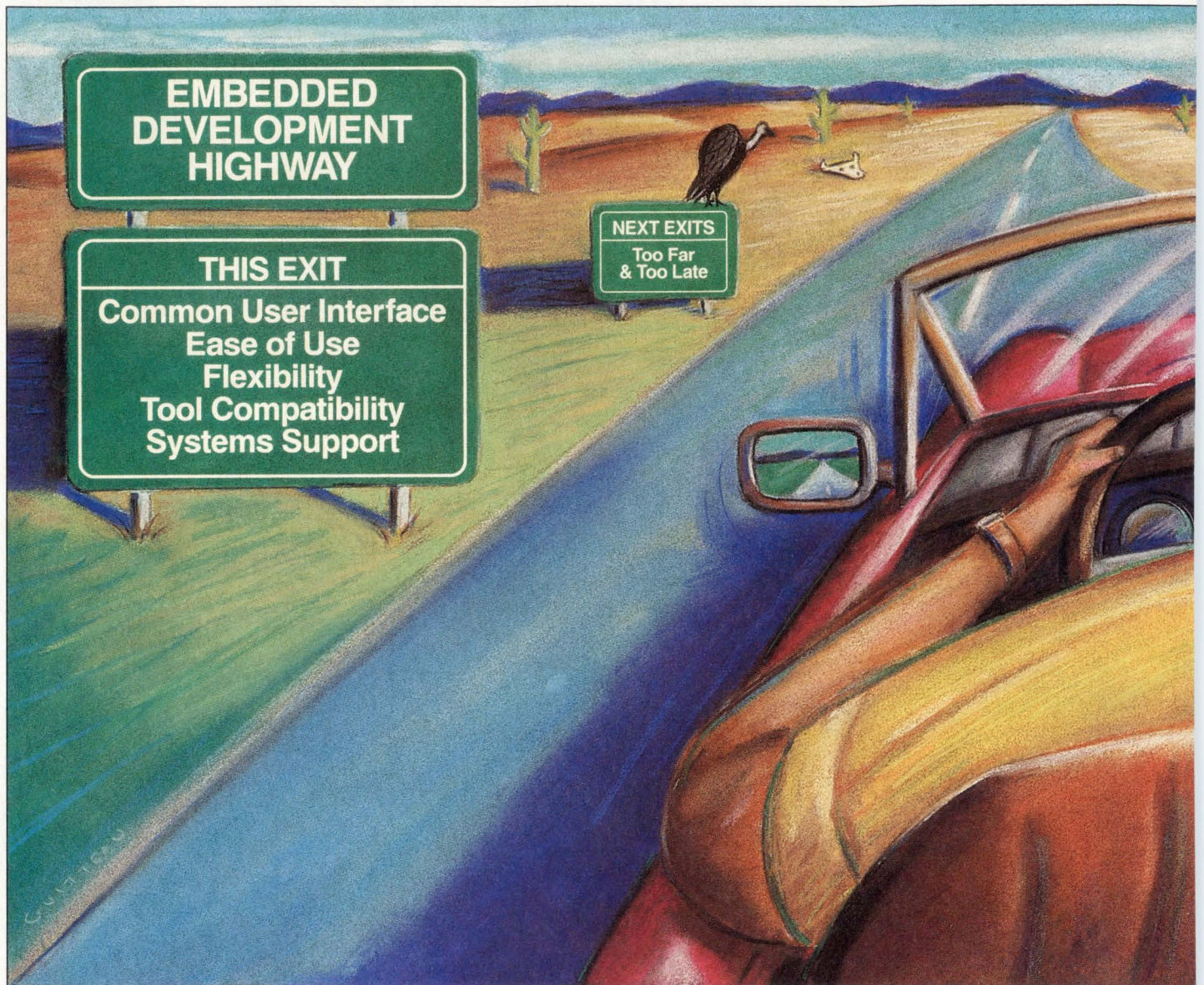

Planning a large-scale embedded development project isn't exactly a Sunday drive. A wrong turn now could mean hazards further on.

There could be networking problems.

Learning curve and team issues. Incompatibility between tools and systems from different vendors.

And of course, the ever-present question of support.

#### Major microprocessors supported by our development systems:

<b>Intel</b>	<b>Motorola</b>	<b>Zilog</b>
i960 CA	68030/EC030/020	Z8001
80386/286	68302	Z8002
80C186/188	68000/08/10	
80186/188		
80C86/88	<b>AMD</b>	
8086/88	Am386 DXL	

So here's a word to the wise: Talk to Applied before you've reached the point of no return. We can show you how to avoid costly detours.

# down the road, talk to us.

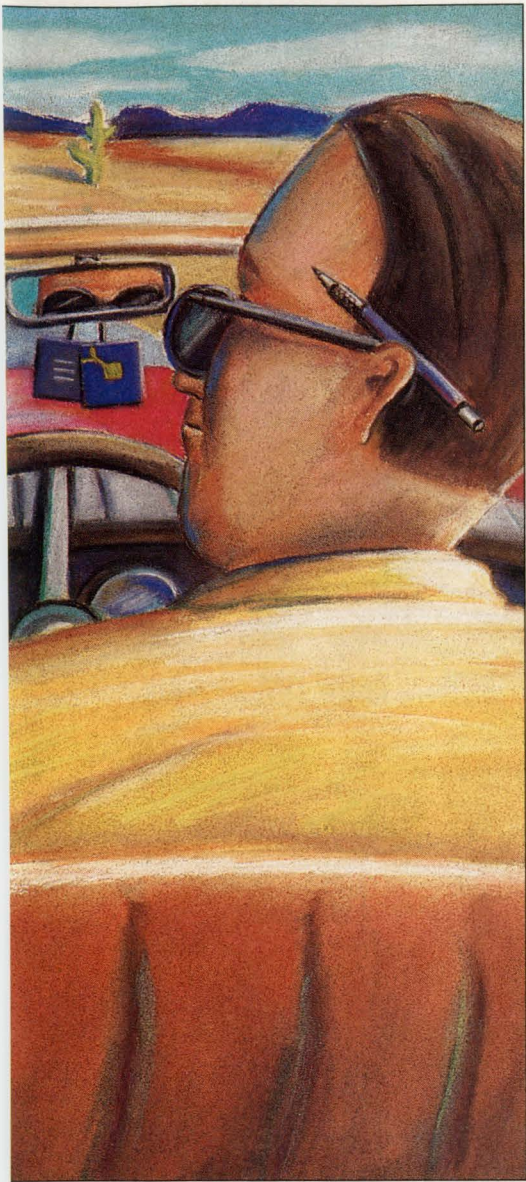

## The right tools for the job.

We've designed our family of development solutions to be as flexible as they are powerful. Our emulators, simulators, CodeTAPs (Target Access

Probe), debuggers, and compilers all work together seamlessly through a common interface. And our software lets you use many of your existing tools, so you can maximize the investments you've already made.

With our new CodeTAP family, you can afford to equip each software engineer with a powerful, in-circuit tool that puts emulation technology on their desktop. Which means that more engineers can be debugging more lines of code, earlier in the development process.

## We know the territory.

When it comes to large scale, high performance embedded development projects, we've been there. And not as a side business, but as our only business.

We've set up more than 12,000 embedded development systems worldwide. The majority of the world's top electronics companies use our solutions.

You couldn't hire somebody with that kind of experience. But when you put Applied to work for you, all this knowledge and understanding is at your disposal. It comes with the territory.

## We're with you all the way.

If you've been stranded by vendors before, take note: We're with you for the long haul, providing you not only products and systems, but also planning, field

engineering support, training, product upgrades, and complete documentation.

Sound good? Then call us at 1 800 343-3659 (in Washington call 206-882-2000) and let's talk about your specific development problems.

We'll help you find a solution that's right on track.

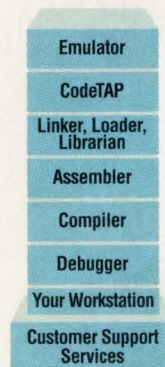

*It all comes together through our integrated, systems approach.*



**Applied  
Microsystems  
Corporation**

*Where it all comes together.*

## WANTED EXPERIENCED EDA ASSISTANT

Must be friendly, intelligent and easy to work with. Capable of handling complex board design from start to finish. Require ability to work with both novice and expert users. Please respond today.

# HIRE INTELLIGENCE.

## CADSTAR™

EDA SOFTWARE

238 Littleton Road  
Westford, MA 01886  
Phone: 800-356-8352  
Fax: 508-692-4725

- Objective:** Provide intelligent PCB design assistance on a PC platform.
- Education:** Easy to learn, OSF/Motif™ style graphical user interface integrated across schematic capture, layout, autorouting. Toll free hotline support provided.
- Personal Skills:** Proactive interface anticipates designer's next move and intelligently defaults to the logical command, saving thousands of keystrokes per design. User defined hot keys and macros multiply this power.
- Experience:** Proven ability to design double-sided, multilayer, SMD technology boards. Comfortable with analog, digital, or mixed signals. Capacity for 2,000+ parts and 10,000+ connections.
- Description:** Integrated schematic capture, layout, autorouting, manufacturing outputs. 5,000+ part library. Analog design functions include curved tracks, teardrop pads, copper hatching, copper pouring and more. Forward and back annotation. Automatic routines for placement, gate and pin swap, component rename, routing and more.
- Associations:** CADSTAR Advanced Router. DOS-based, 100% completion router has gridless, rip-up and retry, shove aside technology. May be bundled with CADSTAR for unparalleled performance at a great price. CADSTAR is fully compatible with MAXI/PC and upwardly compatible with Racal-Redac's sophisticated, workstation-based EDA Expert Series.
- References:** 10,000+ satisfied design engineers worldwide.
- Availability:** Available immediately.

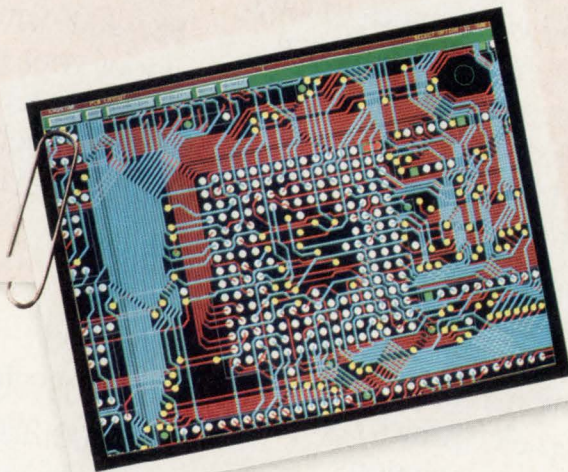

Call for more details and your free  
CADSTAR demo disk.

1-800-356-8352

## CADSTAR™

EDA SOFTWARE

## RACAL-REDAC

**RACAL**

Racal-Redac, Inc.  
238 Littleton Road  
Westford, MA 01886 USA  
Fax: 508-692-4725



# PC-based CAE/CAD: any task, anywhere, anytime

*The PC is today's most popular engineering platform. Portable, powerful, fast, and inexpensive, it's a match for workstations in all but the most demanding CAE/CAD applications.*

**T**he personal computer has gained wide acceptance as a platform for computer-aided engineering and design (CAE/CAD). Not an 8-bit slowpoke anymore, today's PCs are as fast and effective as workstations were a few years ago. It's true that workstation technology has also improved, so they're still an order of magnitude faster and more powerful than most PCs—at least as far as raw Mips are concerned. Nevertheless, the PC has proved to be powerful enough to handle almost any task associated with electronic product and system definition and design.

The PC—and more specifically, the IBM PC, PC/XT, PC/AT, PS/2, and compatibles—has become by far the most common platform for CAE/CAD design, in part because for many years such a machine was almost always found in offices and labs to help document, budget, track, and perform other nonengineering related functions. Today, 286-, 386- and 486-based machines rank first, second and fourth respectively as the most widely used engineering platforms.

The sheer size of the overall PC market has made this dominance possible by spurring all types of peripheral offerings. This keeps competition at its sharpest and provides users with the benefits of low-cost, high-quality equipment.

Of most interest to engineers, however, aren't issues of cost or operating speed; rather, they're concerned with the PC as a serious platform for design automation, test, debug, documentation, and management. "A lot of the engineers we deal with use our tools rather than wait for time on one of the large workstations," says Carl Droste, engineering manager at Omaton

Jon Gabay,  
Contributing Editor



## ■ PC-BASED CAE / C A D

(Richardson, TX). "Why should an engineer wait to get his design in the queue when he can lay it out, simulate it and route it on a PC? With a 50-MHz 486 PC, our tools can get a board design completed in time that rivals workstation-based tools."

### ■ Start with schematic capture

At the front end of the design process is schematic capture. This constitutes perhaps the largest use of the PC in engineering. An effective schematic capture tool creates an automated way of solidifying concepts in graphical form. Primitive elements from vendor-supplied or user-generated libraries are placed in a graphical workspace and moved around and interconnected as needed. Labels define key signals; text documents comments; and connectors, headers, standoffs, and module ports connect to all signals—I/O, power, test points, and intersheet schematic pages. Output is generated as documentation, and can be produced in formats which can be passed along to other design tools aimed at specific disciplines.

Choosing the right schematic capture program for your specific needs is like buying a new car. Price is a factor, as are speed and performance, as well as the options that tailor a vehicle to individual preferences. Especially important is compatibility.

With a car, you don't buy a Miata if you need to haul furniture. With schematic capture software, don't get a package suitable for ASICs if you're designing printed circuit boards. "I've always contended that the most important consideration isn't the platform but the application," says John Durbetaki, CEO at OrCAD (Hillsboro, OR). "If you can do your job on a PC, there's no reason to look elsewhere. The important thing is to know what you want to do and then choose the tool and the platform for the job."

A distinguishing characteristic of schematic capture programs is

whether they're bundled into applications or come in flexible general-purpose packages. Bundled packages, such as Master Designer from P-CAD, EE Designer III from Visionics and Highwire from Wintek, offer systems with consistent user interfaces and operating environments. Included in these packages are digital and analog simulators, layout aids such as rat's nesting and force vectors, autorouters, design and electrical rule checkers, and library maintenance tools for schematic, simulation and layout models. They provide automated placement of

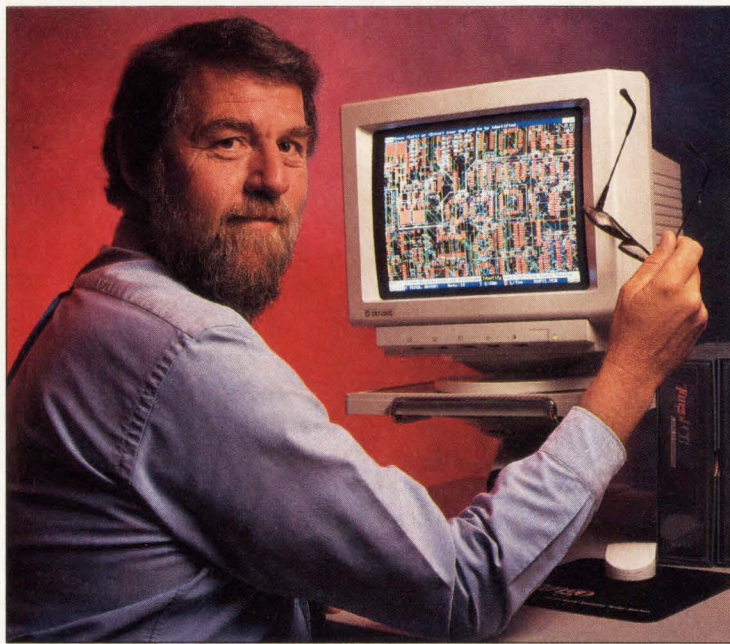

*"We know that the majority of PCBs today continue to be designed on PCs and not workstations," says Jerry Burwell, vice-president of engineering at Accel Technologies. "With affordably priced design software and powerful 386- and 486-based machines in plentiful supply, the price/performance curve is still skewed in favor of the PC and complementary tools as a system alternative to the workstation for PCB design."*

components, as well as photoplot generation tools for Gerber output.

### ■ In the beginning

P-CAD (San Jose, CA) was among the first companies to offer an integrated schematic capture, simulation and PCB layout package. It now offers an entire suite of discrete and integrated CAE tools. Its entry-level Master Schematic Capture program features over 6,000 parts in a comprehensive library, up to 99 levels of hierarchy, design rule checking, and forward and backward annotation.

FutureNet (Redmond, WA), a Data I/O company, another pioneer of PC-based CAE, developed the Dash schematic capture environ-

ment. Later acquired by Data I/O, FutureNet developed a netlist format which is still widely used as a de facto standard for both third-party and its own tools.

OrCAD also offers a widely-used schematic capture program. OrCAD SDT IV, the current version of the company's schematic design tool, has matured to include an operational shell that manages designs by helping you keep track of all filenames and extensions associated with a project. In addition, the shell lets you integrate your own or other company's tools into the design environment. This framework also lets you use OrCAD tools all the way through a design, or you can pass along schematic data to third-party toolsets.

An important feature of OrCAD's low-cost design tool for board- and system-level designs, as well as PLD and ASIC designs, is its large library of design elements, as well as the ease with which designers can define custom parts either graphically or via text files.

Other companies with low-cost schematic capture tools include Accel Technologies with its Tango Schematic Series, Omation with Schema III, Pads Software with its namesake, Pads, Visionics with EE Designer III, and

Wintek with Highwire. Recently released by Accel (San Diego, CA), Tango Schematic Series Version 1.3 features a user interface based on the company's Tango PCB software that's both easy to use and to learn. It also boasts a third-party library with more than 20,000 unique elements.

"We hear many reasons why people opt for PC-based EDA tools," says Jerry Burwell, vice-president of engineering at Accel. "One of the most often cited, after price, is ease of use. PC-based software is likely to be much easier to use than its workstation-based counterparts, with capabilities and performance that far outshine what was available just a few years ago."

# LISTEN.

**"P-CAD helps us transform abstract engineering concepts into sound designs."**

*Jeff Rowland*  
Jeff Rowland, President

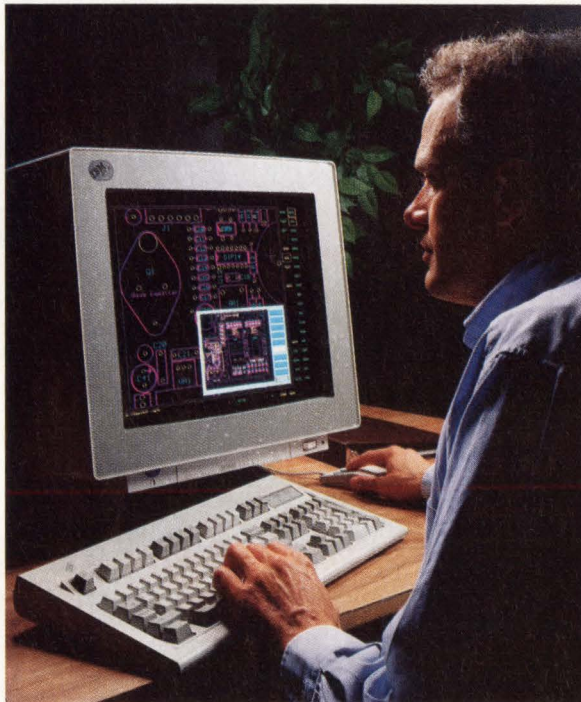

## Sound PCB designs, with P-CAD® software.

Jeff Rowland Design Group creates high end audio products that are not only elegant in design, but are technically innovative as well.

The Jeff Rowland product design strategy emphasizes the control of complex field interactions and electrical geometries. And this task demands the finest PCB design software available.

P-CAD designed PCB products give Jeff Rowland engineers the speed and features they need to design minimum area layouts with custom path geometries.

P-CAD also combines an easy to use interface with end-to-end integration, so audio electronics designs can be completed and verified to support the world's most demanding product quality and performance criteria.

## P-CAD products, unique as your application.

P-CAD products include all the interactive and automatic tools you need to complete PCBs, from symbol creation through manufacturing.

All made possible by P-CAD's open architecture and its interfaces to a wide range of third party tools such as VIEWlogic®. P-CAD lets you easily exchange PCB files with your favorite

mechanical CAD programs such as CADAM's MICRO CADAM®. And whether it's a DOS or UNIX®- based solution you're looking for, there is a P-CAD product that is engineered to meet your desktop PCB design needs.

## Now hear this. Here's how to get a free P-CAD demo\*.

When it comes to designing better PCBs faster and more productively, the advantages of P-CAD are definitely worth hearing about. To take advantage of this free offer for a hands-on demonstration, just call us for the name of your nearest CADAM Value Added Reseller. If you think this offer sounds great, simply call today toll-free: **1-800-255-5710**.



**CADAM**  
AN IBM COMPANY

**World Class PCB CAD Productivity**

\*Available from CADAM Value Added Resellers. Contact CADAM for details. IBM is a registered trademark of International Business Machines Corp. CADAM and MICRO CADAM are registered trademarks of CADAM INC. P-CAD is a registered trademark of Personal CAD Systems, Inc. UNIX is a registered trademark of UNIX Systems Labs, Inc. VIEWlogic is a registered trademark of Viewlogic Systems, Inc. CADAM INC., 1935 N. Buena Vista St., Burbank, CA 91504. © 1992 CADAM INC.

## PC-BASED CAE / CAD

Another very recent entry into the low-cost schematic capture market is Schema III by Omaton, which features an easy user interface, a 7,000-part library, design rule checking, unlimited hierarchy, and more. Schema III also lets you export design data to ASCII, AutoCAD DXF, DBase, Lotus, PostScript, and TIFF formats, so you can send design data to other departments and integrate with tools they may be using.

Viewlogic Systems (Marlborough, MA) is another force in PC-based

trace density histogram as a placement aid. Viewlogic supports VHDL, making its simulator ideal for ASICs, PLDs and FPGAs. Visionics includes a thermal analysis package for heat modeling.

An interesting new product from Dazix/Intergraph (Huntsville, AL) is Ace+ PC Entry software. Dazix/Intergraph, primarily in the workstation mar-

was first undertaken on PCs, and is still, for the most part, handled on that platform. In the early days of proprietary software, there was Palasm from Monolithic Memories,

Inc (MMI) and Amaze from Signetics, as well as products from third-party PLD software pioneers: Abel from Data I/O and CUPL from Assisted Technologies (now part of Logical Devices).

Many companies, both third-party suppliers and manufactur-

ers, provide PLD support tools for the PC. Third-party tools are the most flexible, since they generally support parts from various manufacturers. "In general, there's more software available for engineers because of the inroads that PC-based tools have made," according to Karen Wills, product marketing manager at Viewlogic Systems. "If you're looking to develop and market a design tool, a PC platform is more accessible than a Unix one. It only follows that good PC software will be developed to help people use the latest devices, whether they're PLDs, FPGAs or other ASIC technology."

### Third-party downside

On the down side, however, is the fact that third-party tools often come later in supporting new devices on the market than the tools of the device manufacturers. The latter, then, usually provide the fastest way of designing in a new part.

The most popular third-party tool by far is still Abel from Data I/O (Redmond, WA). Abel has grown from a strict Boolean transformation software to a comprehensive environment for capturing, synthesizing, testing, programming, and partitioning designs onto PLDs. It's also a plus for Abel that parent company Data I/O is the leader in PLD and FPGA programmers. The company can provide a complete solution for design, prototyping, testing, and production of almost any part in the marketplace.

CUPL may be an old timer by comparison, but it hasn't been standing still in terms of develop-

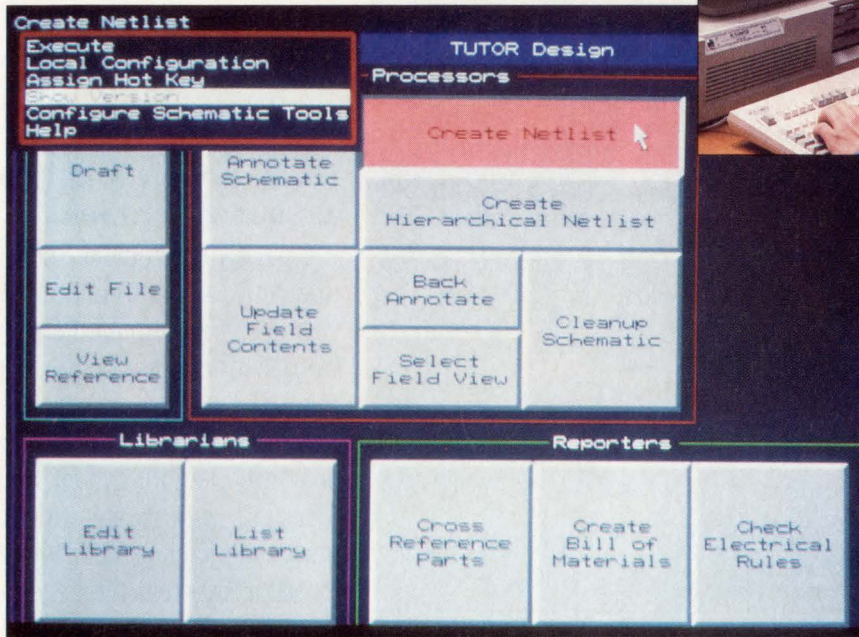
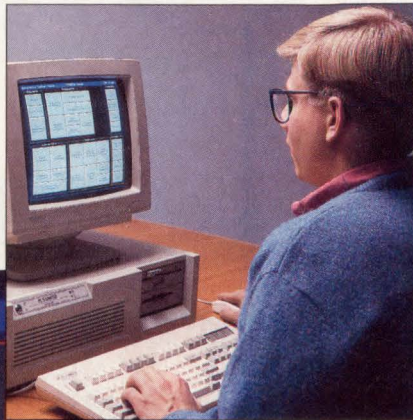

The design shell implemented in OrCAD's SDT IV permits you to easily and quickly configure for different projects and mix various third-party tools within a single design environment.

schematic capture and simulation, with a product line that's a bit more costly than most. But its philosophy, shown in advanced features such as multiwindowed operation, tightly coupled and seamless integration between digital and analog simulation with schematic capture, and strong alliances with ASIC, PLD and FPGA vendors, as well as PC-board design automation systems currently in use, has paid off.

### Alike, but different

While all the schematic capture programs mentioned share common features, such as the ability to create and maintain symbol libraries and schematics and to generate netlists for use with other design automation tasks, special features differentiate these packages. For example, P-CAD features a unique

ket with ASIC, PCB and multichip module designs, has recognized the usefulness of the PC as a design entry system and has targeted Ace+ PC Entry as a low-cost way to get started with the company's comprehensive design environment. File-compatible with the larger and more costly Dazix/Intergraph workstations, Ace+ PC Entry transparently integrates the PC into the Dazix/Intergraph CAD/CAE/CAM environment and can run on 286, 386 and 486 systems under Microsoft Windows 3.0.

Although the PC is just an entry station, symbols and schematics created on it can be used as source files for workstations, which can then simulate and lay out designs, providing the engineering department with more design seats for the buck. The design of PLDs is a task that

# Modular Packaging

For VMEbus, Multibus II, Futurebus+, and Other Industrial Bus Systems

Enclosures and Backplanes from ELMA Electronic are designed to meet the highest standards of precision and dependability. We offer both **standard** and **custom** products for a wide variety of buses, including VME, VXI, SUN, Multibus II, PC/AT, Futurebus+, and many more.

ELMA's unique modular approach satisfies a wide range of applications with off-the-shelf components, eliminating expensive and time-consuming custom work. ELMA covers your requirements from individual components up to fully wired and tested ready-to-run enclosure systems.

To receive more information on our line of professional packaging products, please mark ELMA on the Reader Service Card or give us a call today.

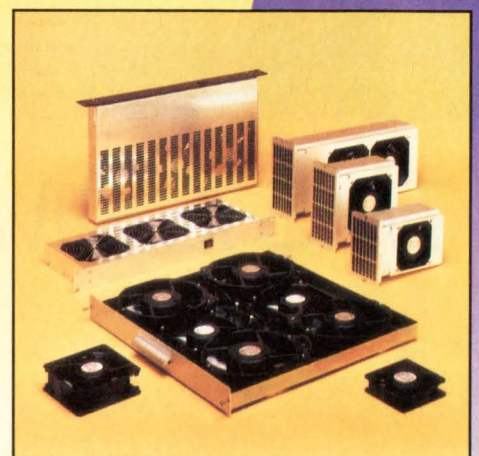
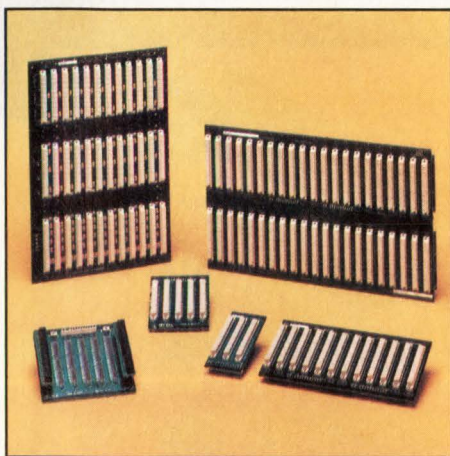

**ELMA**

ELMA Electronic Inc • 41440 Christy Street • Fremont, CA 94538  
(415) 656-3400 • Fax (415) 656-3783

CIRCLE NO. 11

*.050 centerline stackers.  
Close, closer, closest.*



***THIS IS AMP TODAY.***

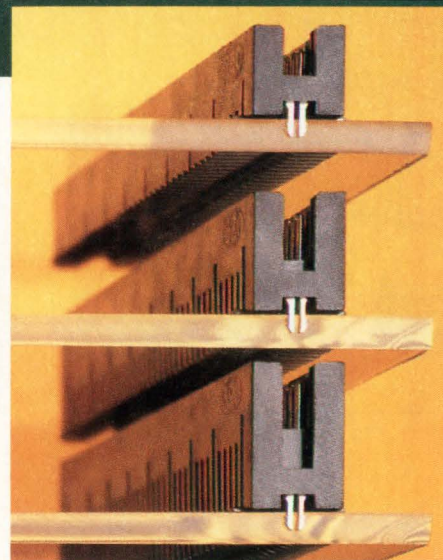

*Surface-mount stack heights: .250" / .320" / .390"*



AMPMODU 50/50 Grid Connectors give you a choice of parallel pcb stack heights: .390", .320", and a very close .250" (the tightest in the industry). So you can squeeze everything possible out of (or into) your design.

This surface-mount system utilizes a .050" contact grid in double row, polarized shrouded headers and receptacles, and offers our exclusive plated copper alloy holddowns. On standard .062" thick boards, the

barbed holddowns do their job without protruding through, allowing surface mounting on both sides. And holddowns are soldered during reflow, providing long-term strain relief.

Dual-beam receptacle contacts and duplex gold plating provide high reliability, in selected sizes from 10 to 100 positions. Dimensional tolerances, reference datums, holddown characteristics, and packaging support robotic application; materials are fully

compatible with IR and vapor phase reflow processing.

Ask us for more information on the AMPMODU 50/50 Grid Surface-Mount Connector System. Call the AMP Product Information Center at 1-800-522-6752 (fax 717-986-7575). In Canada call 416-475-6222. AMP Incorporated, Harrisburg, PA 17105-3608.

**AMP**

CIRCLE NO. 51

## PC-BASED CAE / CAD

ment and it's still very widely used. Originally developed by Assisted Technologies, CUPL was later acquired by P-CAD, and then was sold to Logical Devices (Ft. Lauderdale, FL), where it's now marketed both with and without the company's PLD and PROM programmers. CUPL has many advanced features, such as mixed input formats (schematic, truth table, Boolean, state-machine syntax, and high-level language constructs), a powerful simulator (CSIM for verification and

including schematic capture, compact indexed notation, powerful transformation mapping, and standard Boolean, truth table and state-machine syntax.

Accel's recently introduced Tango-PLD supports 113 PAL, GAL and PEEL devices, including parts from Altera. Tango lets you enter in design equations or schematics, and then performs minimization and reduction before you've chosen a target part. You can then simulate for functional verification, choose a part

OrCAD and Viewlogic, PLD Designer also accepts Boolean, truth table and state-machine input formats, and can combine different parts of a design in different formats into one homogeneous whole for single and multiple PLDs.

PLD Designer also features powerful reduction and optimization algorithms for simplifying the PLD design, and has an automated device partitioning and selection scheme. Device partitioning and selection lets you enter such constraints as type of technology (CMOS, bipolar, ECL, or any combination), type of package (plastic or ceramic DIP, LCC, SO), number of devices, maximum power, and speed constraints.

In the next step, PLD Designer checks through its large library of parts and comes up with all the possible solutions that can house the design. You then choose the optimum solution, and PLD Designer generates the fusemaps and documents the design. PLD Designer also includes a simulator which can use waveform entry to define the simulation stimulus pattern.

A unique tool providing synthesis support for a device-independent FPGA design comes from Exemplar Logic (Berkeley, CA). The company's Complete Optimization/Retargeting Environment (Core) lets you target a specific FPGA anywhere in the design cycle. Supporting multiple design entry formats (VHDL, schematic, Boolean in Abel, Minc and Palasm formats), Core permits you to merge new or existing PAL or FPGA designs together, reduce and optimize for a target FPGA and generate fusemaps for that particular flavor of FPGA. Currently supported are Actel, Altera, Concurrent Logic, Crosspoint, Cypress, QuickLogic, and Xilinx parts.

### Manufacturers make tools, too

In addition to third-party PLD tools, manufacturers offer tools that aren't to be scoffed at. Take Snap, for example, the latest generation of PLD design tools from Philips/Signetics (Sunnyvale, CA). This streamlined tool links to schematic capture and features waveform entry (for simulation vectors), reduction, minimization, resource allocation, fusemap generation, and programmer support. Although initially targeted for the new programmable macro logic (PML) family of devices, the software is being extended by the com-

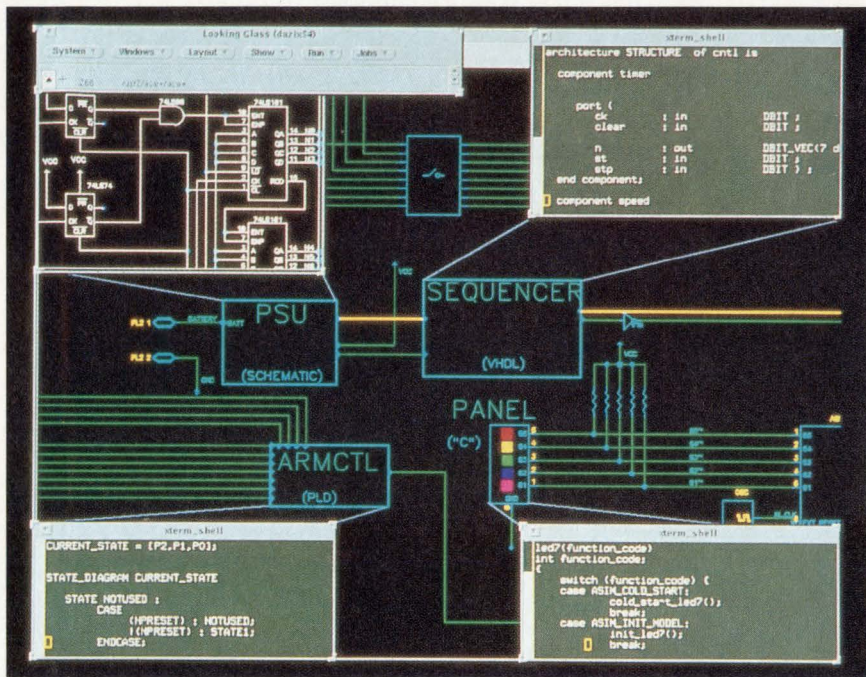

Using simultaneous windows, Ace+ PC Entry software from Dazix/Intergraph lets you take advantage of low-cost PCs as entry stations which integrate with the company's higher-powered workstations for ASIC, PCB and MCM designs.

test vectors) and a choice of one of four reduction/minimization techniques. Although CUPL isn't as popular as Abel and doesn't come from as large a manufacturer as Data I/O, it benefits from the expertise of Logical Devices, which is a PLD and FPGA software vendor as well as a device manufacturer.

### New and traditional approaches

Recent tools from OrCAD, Accel, Omaton, Minc, and Adams MacDonald have been hitting the streets with both traditional and new approaches to the PLD design problem. OrCAD, with its OrCAD PLD software, has come up with an advanced syntax and notation for expressing complex functions compactly. OrCAD PLD lets you choose a notation format which is most suitable for a specific design, in-

and generate a JEDEC fusemap. The simulator can model multiple PLDs, meaning that test vectors can be generated for several devices to aid in board-level testing.

Omaton's Schema PLD logic compiler also provides schematic capture input. In addition, it accepts Boolean, truth table and state-machine input formats and features a variable-like language to help simplify equations. Schema PLD incorporates minimization (which can be enabled or disabled), as well as reduction (Presto, Quine-McKlusky and a proprietary technique), to help generate resultant equations more efficiently for a particular device's architecture.

A powerful PLD software for PCs is the PLD Designer from Minc (Colorado Springs, CO). Accepting schematic netlists from FutureNet,



pany to cover all its PLDs and has replaced the earlier Amaze software.

Altera (San Jose, CA) also has an advanced PLD design package, called APlus+, which runs under DOS, and Max Plus II, which runs under Microsoft Windows 3.0. The software includes schematic capture, simulation and fusemap generation. Recent introduction of the company's PLS-EDIF translator now lets PC users work with workstations from Cadence, Dazix, Mentor, Valid, and Viewlogic.

Xilinx (San Jose, CA) offers a powerful PC-based FPGA design tool for the PC. The very popular RAM-based Xilinx FPGAs have found widespread use, partly due to the good quality of XACT software. Using Viewlogic software as a front end, the highly graphic Xilinx development system places and routes your functions, estimates timing of the resulting design, back-annotates timing information into the Viewlogic Viewsim simulator, generates fusemaps, and lets you hand-tweak resource allocation and placement and routing of critical paths.

A new Xilinx tool called Blox generates custom cells from user-defined input parameters, much like a silicon module compiler. In addition, Xilinx has forged alliances with Data I/O for Abel support, as well as with Minc for FPGA Designer support.

Actel and Texas Instruments also use Viewlogic schematic capture and simulation capabilities in their software. (Both companies manufacture one-time programmable fusing-link FPGAs.) Primary rivals of Xilinx software, the tools are similar as far as design capture and simulation are concerned, but they're a bit more automated and don't let you manually edit the layout, as do the Xilinx tools.

Some designers feel this is a plus, since it eliminates another step in the already iterative design process; others disagree, feeling it's a minus since design optimization is solely in the hands of the automated tools.

## ■ New arrivals

New to the scene is QuickLogic (Santa Clara, CA), which recently introduced the pASIC Toolkit for its family of antifuse-based, high-density FPGA devices created by John Birkner, co-inventor of the PAL. The pASIC Toolkit combines design capture (schematic capture and language entry) with simulation, automatic test pattern generation and place-and-route under Microsoft Windows 3.0. As is the case with Xilinx software, a physical layout and path editor lets you manually tweak designs for optimum perfor-

Other part manufacturers offering PC-based PLD and FPGA design tools include Advanced Micro Devices, Concurrent Logic, Crosspoint, Gould, ICT, National Semiconductor, Plessy, and Texas Instruments.

## ■ The PC PCB era

No matter what parts are being designed, sooner or later they'll be fitted into a PCB. This is yet another major area where PCs have made much headway.

The PCB dominates almost every type of electronic system and subassembly. A mature industry, PCB manufacture is still subject to rapid

advancements in development tools and methodology, prototyping alternatives, test requirements, and production capabilities and limitations. Reasonably priced and widely available, PCB design tools and services relieve designers of the painstaking, error-prone and time-consuming handwork they had to perform only a few years ago. Such tools provide a uniform design environment from which you can easily place components, wire tracks, verify integrity between schematic and physical layout, and generate artwork for manufacturing. Also, highly efficient auto-routers take the head-

aches out of squeezing traces into dense areas, and some tools even perform parameter extraction and thermal analysis.

Some systems, such as Racal-Redac's Maxi/PC and Cad Star, the Great Softwestern Company's Auto-board, Highwire from Wintek, P-CAD's Designer Series, the Visionics EE Designer series, and ProCAD Xtra from Interactive CAD Systems, provide their own proprietary schematic capture tools tightly coupled to PCB tools. An advantage of integrated schematic capture is the uniformity of the user interface. If you use a common interface, you don't have to master the personalities of several different software packages, and you can be up and running quicker. A disadvantage of this approach is that integrated schematic capture may be clumsy or lacking in some features which you

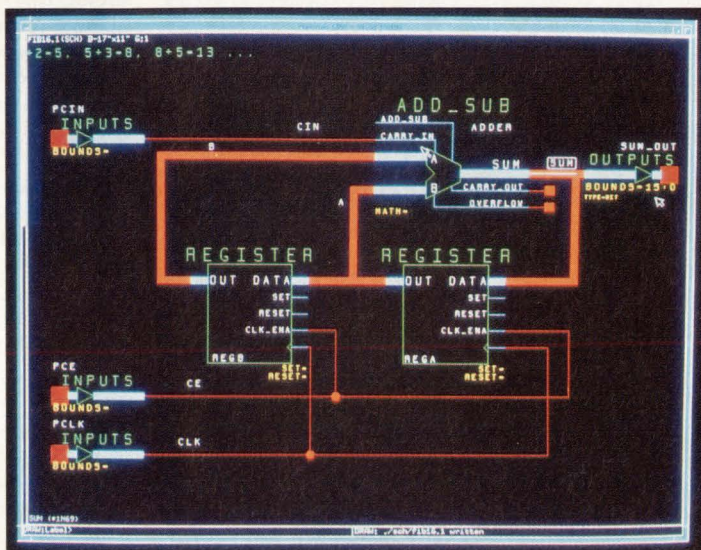

*Blox software for Xilinx FPGAs allows you to define functional blocks which the software then compiles to a semicustom cell for use in the Xilinx LCA families of parts.*

mance—important since the device touts a 100-MHz operating speed.

Another recent arrival is the Lattice Semiconductor (Hillsboro, OR) pDS development system, which also runs under Windows 3.0. While Lattice has provided simple PLD tools for quite some time now to support its popular GAL family of devices, the pDS package is dedicated to the new EEPROM-based 1032 super-PLD. Only providing Boolean entry at present, the software is scheduled to have a schematic capture-based version which will also synthesize logic from VHDL source code. Unique to the Lattice product is the capability of reprogramming the parts in-system while remaining nonvolatile, thanks to 5-V-only EEPROM. The pDS development system generates the fusemaps for in-system programming or for using standard packages.

## PC-BASED CAE / CAD

require or desire, such as automated bus member labeling, auto-incrementing reference designation or on-line library editing. You don't want to pay for redundant software, so whatever is currently used in-house should play an important role in decision-making, unless it lacks some crucial feature.

In the latter case, you may want to put your own system together. Some companies, such as Accel, Omaton, OrCAD, and Pads, let you choose third-party schematic capture tools as

through-hole-mounted devices. Design aids such as rat's nesting and rubber banding make placement iterations easier, since uniform trace density becomes visible. In addition, a rip-up and reroute router guarantees 100 percent route completion, even when priority routes are defined to help minimize the trace length of critical path signals.

OrCAD, Omaton, Accel, Visionics, Racal-Redac, Ultimate, Wintek, and others also provide fine PCB design tools. The OrCAD PCB II

nection rat's nesting and rubber banding are also provided to help optimize placement.

Accel's latest PCB tools are also outstanding. The new version of Tango PCB/PCB Plus Version 2.X adds many features to this already smooth, effective and easy-to-use program. Tango PCB now provides polygon support for analog design assistance, automated component placement, autopanning, keyboard macros, backannotation, and enhanced expanded memory specification (EMS) support. Another improvement is a multipass maze router, which breaks up routes to speed up the routing process and utilize memory more efficiently. A nice feature of Tango PCB is the ability to check physical layout against a schematic to verify that what you've gotten is what you want.

Visionics (Santa Clara, CA) offers an advanced PCB layout and design package which is still among the top contenders. Although Visionics offers the EE Designer III integrated design environment for schematic capture, logic simulation, linear simulation, and PCB design, the company also markets its PCB design tool separately for those who want to use a different front end.

The EE Designer III layout package features a clean user interface which uses a shell structure to walk through each design phase. The automated place feature speeds design instantiation and gives a good overall starting point from which to optimize component placement. In addition to rat's nesting, EE Designer III also features force vectors to aid in component placement.

One feature that makes EE Designer III stand out is its thermal analysis capability. This feature calculates component and junction temperatures as well as board temperature gradients. Parameters from a library file or ones that are interactively loadable or editable include board dimensions, board thickness, conductivity, copper thickness, component package types, package thickness, cooling (emissivity coefficient), and much more. Analysis is displayed as a temperature map on the screen.

### What you sim is what you get

While not as many companies offer logic simulators, there are still choices for you to make. Companies offering discrete logic simula-

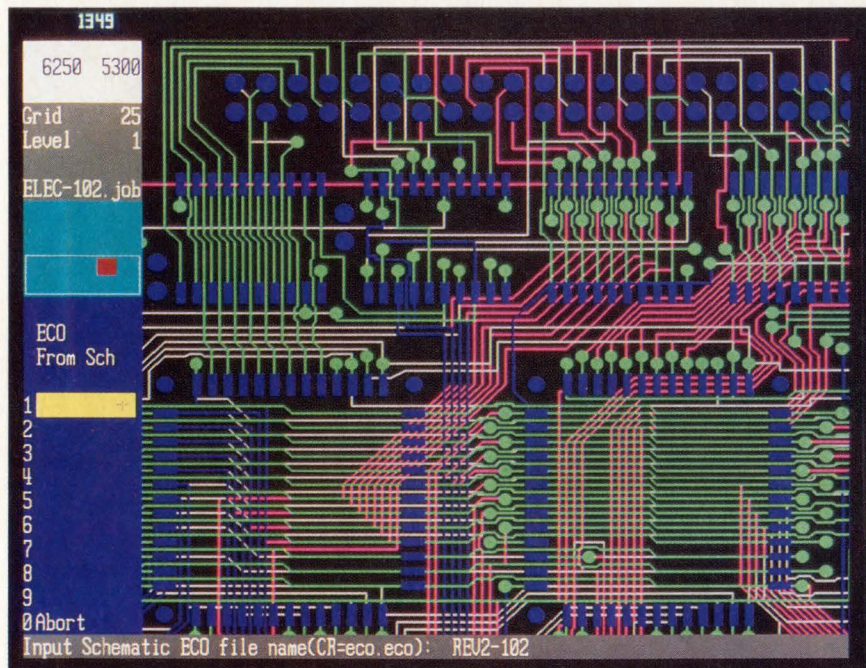

*The quality of a PCB designed using a PC-based layout tool can be just as good—or better—than that achieved using a high-end workstation-based tool, since the deciding factor is really the designer's experience. This PCB designed on a Pads PCB Designer is a case in point, and is as good as one designed on a workstation-based layout tool.*

front ends to their PCB design programs, or you can use bundled tools from the same company.

An early entry in this area, and still a strong one, is P-CAD's Master Designer PCB design tool, boasting over 14,000 installed systems. Integrating tightly with the parent company's or third-party schematic capture tools, Master Designer has the power to handle up to 32 layers of a 60 x 60 in. board with up to 2,500 components, 4,000 nets and 32,000 pins. Master Designer also has special rules, such as filled polygons, trace hugging, curved traces, and trace plowing, to help analog designers create analog or mixed analog/digital PCBs.

An extensive PCB library includes surface-mount as well as

software now features a rip and re-route router; backannotation support; PostScript, IGES and DGIS graphics support; and a more comprehensive surface-mount library. Again, the user interface follows OrCAD's tradition of pop-down menus, macro support and flexible I/O device support, making OrCAD PCB fit easily into OrCAD's or your existing design center.

Omaton's PCB software, Schema PCB, also has some nice features. An autoplacement option speeds part entry. Calculated minimum distance algorithms facilitate ideal placement of components. Autoplacement is almost always modified by a designer, but the function saves time in instantiating and relocating every component on the board. Con-

# Only the best in outer space

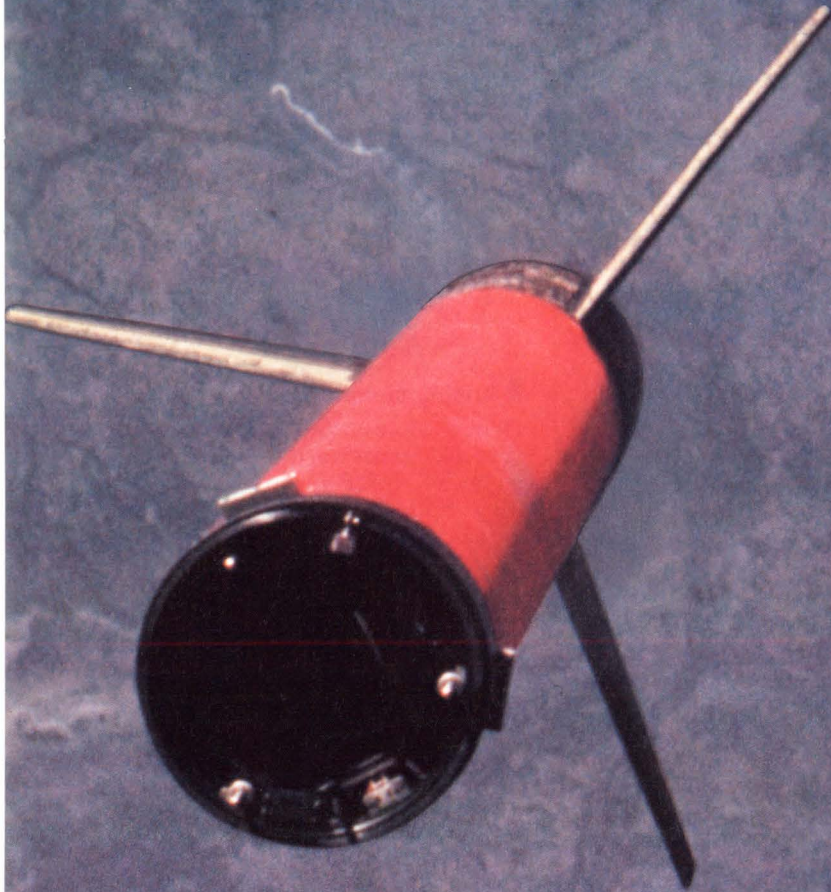

In outer space, 700 kilometres over the earth's surface, conditions are at their harshest. Huge investments depend on the reliability of every single component. Failures can be fatal. That's why professional computer users rely on **or** products. You too should only have the best for your money.

**or** provides one of the largest selections of single height VMEbus boards, consequently designed in a CMOS technology. Our range contains 68000 family and IBM compatible CPU boards, signal processors, graphics, industrial I/O, mass storage and network controllers as well as OS-9, VRTX 32, VxWorks, PDOS, PSOS<sup>+</sup>, RTOS and MSDOS operating systems.

Our CPU family has only recently been extended to include the high performance VCPU-30 module. For a module with 12 MIPS the price is extremely cost efficient. Boards with the 68040 and 80486 will be available shortly.

# or

oettle + reichler GmbH  
Industrial Computers  
Sieglindestr. 19½, D-8900 Augsburg 1  
Tel. (0821) 5034-0, Fax (0821) 5034-119

In the US and Canada contact:  
**DYNATEM**  
15795 Rockfield Boulevard  
Suite G, Irvine, CA 92718  
Tel. (714) 855-3235, Fax 770-3481

## VMEbus boards able to meet the highest demands

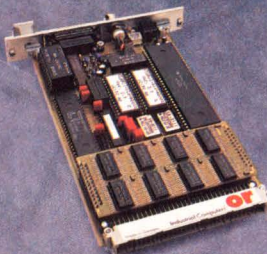

### VLAN-10: Intelligent Ethernet Controller

- Ethernet and cheapernet interface
- 256 Kbyte dual ported SRAM (opt. 1 Mbyte)
- Local 68HC000 CPU with 12.5 MHz offloads the host-CPU and the VMEbus dramatically.
- Easy system-integration
- Operating-system-integration for OS-9, VRTX and VxWorks available

### Network Software for VLAN-10

- TCP/IP ■ OS-9/NET ■ DECNET
- SO/OSI ■ SINEC AP 1.0

**CIRCLE NO. 52**

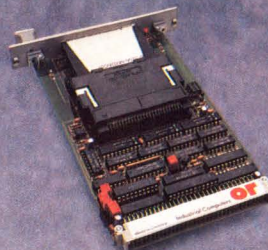

### VMEM-10: Memory Card Interface

- Non-sensitive to dust, shocks and vibrations
- For memory cards up to 8 Mbyte capacity
- 8-bit and 16-bit wide databus
- CMOS RAM or ROM memory cards useable
- Data-transferrate max. 5 Mbyte/sec
- Battery backup and write-protection-switch
- Low battery voltage detector
- Compliant with VMEbus specifications ANSI/IEEE STD-1014 and IEC 821/297 also the high speed address-pipelining
- RAM-Floppy software-driver available
- Optional -40°C to +85°C operating temperature
- Low power +5V, 0.1 A

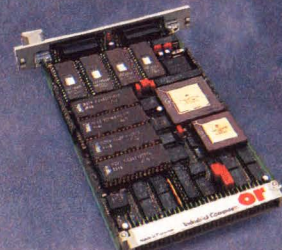

### VCPU-30: High Performance CPU Board

- MC68030 50MHz HCMOS processor
- MC68881/2 floating point unit
- 2 Mbyte dual-ported SRAM max.
- 8 Mbyte dual-ported DRAM max. (burst mode)
- 2 Mbyte EPROM max.
- 2 async./sync. RS-232/422 channels
- Realtime clock, watchdog
- System controller, 4-level arbiter
- Multiprocessor-capability, mailbox-interrupt
- Optional SCSI and floppy interface
- Optional -40°C to +85°C operating temperature
- OS-9, PDOS, PSOS<sup>+</sup>, VRTX and VxWorks available
- Low power +5V, 0.9A

## PC-BASED CAE / CAD

tors include OrCAD, Aldec, Cadat, and Mimic. Their programs accept netlists from schematic capture programs and let you verify the functionality of designed circuits, as well as timing characteristics.

OrCAD VST simulation tool is a powerful yet moderately priced digital simulator which is easy to use, fast and well integrated into OrCAD's design environment. VST features the same interface as OrCAD's SDT tools and can accept commands via keyboard, mouse or

one of the most powerful of the PC-based logic simulators. It's been adopted by Accel, Omation, P-CAD, and others as part of their design environments. The present version, Susie 6.X, features a streamlined user interface which lets you load netlists from schematic capture programs, define input waveforms for circuit stimulus (from waveform entry, tabular vector lists and program-supplied stimulus generators), and perform accurate unit delay and timing simulations for

Another powerful digital simulator is integrated into Viewlogic's Workview. While Workview is a fully integrated and automated design environment, the schematic capture and simulation packages are available bundled for designers. Like Susie, Workview can accept high-level VHDL behavioral models, and it simulates quickly and accurately on a PC. It also integrates with linear simulation, and can network easily for multiuser design support, which is especially important if design teams will be working on different parts of a project. Workview's clean and effective user interface lets you open up a window for each task, making it easier to iterate through the design process.

### Analog simulators

Digital simulation is not the only type of circuit verification possible on a PC. Analog simulators from MicroSim, Intusoft, Tesoft, Etron, EEsof, Interactive Solutions, Meta Software, and others permit accurate linear predictions of designed circuit performance. PC-based analog simulators are mostly based on Spice, a public-domain analog simulation scheme developed at the University of California at Berkeley.

The most widely used to date is Pspice by MicroSim (Irvine, CA). It accepts Spice netlists and generates waveforms from selected nodes as a result of user-defined input stimuli. Pspice is available in different flavors for DOS, Windows, stand-alone analog, and mixed analog/digital simulation. It's useful for determining proper responses to filter design, amplifier stability, noise and impulse response and immunity, and much more. Monte Carlo analysis lets you vary parameters on a random basis, showing yield deviations from tolerance differences between components. The Probe program in Pspice lets you probe on selected nets and display stimulus waveforms right next to resultant waveforms at different points in the linear signal path.

Another improved Spice derivative is the ICAP/386 software from Intusoft (San Pedro, CA), which features behavioral modeling, mixed mode capabilities, Monte Carlo analysis, and sensitivity analysis.

ICAP/386 also integrates a schematic capture program with its simulator. While it and most other analog simulators can accept netlists generated by third-party tools, the integration of schematic capture

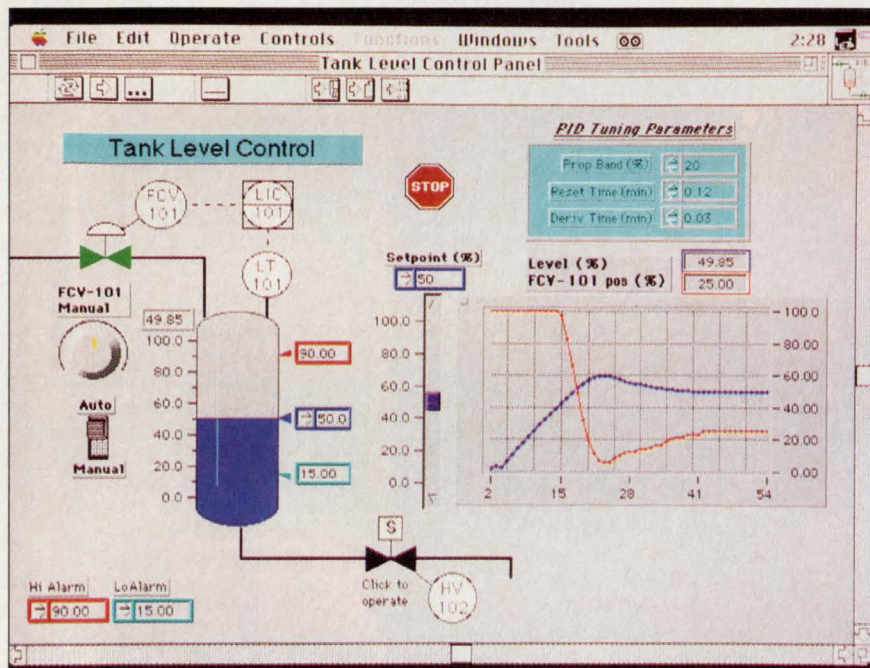

LabView, LabWindows and DAQ Designer from National Instruments let you acquire data, control processes and set up virtual instruments on a PC using plug-in cards as well as remote equipment connected via RS-232, IEEE-488 and VXI interfaces.

combined for highest-speed use.

A trace editor feature lets you create, load and save stimulus and test pattern vectors with absolute or relative timing characteristics. Signals displayed in logic analyzer format can be individual (bit), nibble, byte, and word length displayed in a hex radix. Up to 16 breakpoints composed of AND/OR conditional statements can vector you to the events in question quickly, and up to three simultaneous markers permit rapid extraction of simulated time intervals. OrCAD VST comes with a basic library of TTL, CMOS, ECL, and memory devices. User-definable models are available so you can create your own simulation components.

The Susie (Standard Universal Simulator for Improved Engineering) from Aldec (Newberry, CA) is

single chips, PLDs, ASICs, and circuit boards. Susie's power comes from speed. Completely memory-resident models live within the PC, meaning that disk accesses and memory swaps that drastically slow performance aren't necessary.

A second important feature of Susie is its ability to accept high-level models in either Aldec proprietary format or VHDL. This permits a PC to simulate microprocessors, ROMs, RAMs, and other VLSI functions behaviorally, along with PLDs, TTL, CMOS, ECL, and GaAs components—all with a high degree of accuracy (10-ps resolution) and speed. Simulation models available from Aldec include microprocessors and peripheral chips from Intel, Motorola and Zilog, and third-party VHDL models from Logic Automation and Quadtree.

streamlines the back-and-forth iterations of design and verification. It also simplifies stimulus and response queries, since you can place iconic probes and signal generators directly into the schematic.

Analog simulators aren't limited to linear ICs and transistors. Tesoft (Roswell, GA) provides an interesting product, the Tess (Transient Electronic System Simulator), an interactive communications block diagram simulator that's easy to use and very effective. Instead of simulating the physical effects of transistor devices, it uses a block diagram approach where every block has its own set of transfer functions and parameters. System-level advanced analog simulation takes place very quickly, and as accurately as you need it to be.

Tess is useful for simulating complex analog circuits made up of blocks such as phase-locked loops, audio companders, filter networks, voltage controlled oscillators, phase detectors, function generators, and demodulators. The simulator accepts netlists from OrCAD and P-CAD, and generates clean and visible output plots with powerful features such as spectral analysis, mixed log and linear plots and Lissajou patterns. Since each block is effectively a black box, digital circuits can be simulated too. It's also important that Tess simulates the interfaces between digital and analog circuits.

Another product, RF Notes from Etron Radio Frequency Enterprises (Diamond Bar, CA), is aimed at radio frequency engineers who need to verify filter responses, modulators/demodulators, phase-locked loops, strip line capacitance, resonant circuits, impedance matching, and other specialized RF effects. Menu-prompted queries guide you through parameter entry to resultant response plots of the circuit. In addition to electrical calculations, RF Notes also models magnetic parameters, making transformer, inductor,

torroid, and wire size calculations accessible. This is useful for the design of high-speed digital PCBs and sensitive analog circuits.

XTK 4.2 simulation software is a unique product from Quad Designs (Camarillo, CA) that spans the analog and digital worlds; it's the first software to predict the effects of ground bounce on PCBs. Combining circuit information from schematic capture with layout information from PCB design systems, Quad Designs software

that can offset critical timing can be modeled.

### ■ The PC as a development system

The microprocessor has made the PC possible, but it's also true that the PC has made low-cost and accessible microprocessor development possible. The PC has been instrumental in facilitating the design of microprocessor-based systems, on both the hardware and software sides. So effective are third-party microprocessor development tools, in fact, that microprocessor vendors often don't offer their own development systems anymore.

Microprocessor design is simplified when the code can be debugged on the native system. For example, when writing code for a Z80, a Z80-based PC is ideal to write the source code and assemble, compile and then debug it. But it's unlikely that every microprocessor and microcontroller has a native PC which can be used to debug new code. Instead, dedicated external development systems which can connect to any com-

puter have become the standard, thanks to standard ports such as the RS-232 and Centronics parallel ports. As a result, the most popular computer in use today for microprocessor- and microcontroller-based design and code development is, again, the PC.

"There's a large segment of the market who make PC chip sets, peripherals and PC compatibles who want to develop their next-generation products on their own systems," says Bruce Kane, director of PC products at Racal-Redac (Westford, MA). "It's not only a matter of loyalty to their own products, it's simply more cost-effective for them to use their own equipment. Fortunately, there are plenty of PC-based tools that let them assemble a complete design environment in-house with their own platforms."

PC-based tools available for such

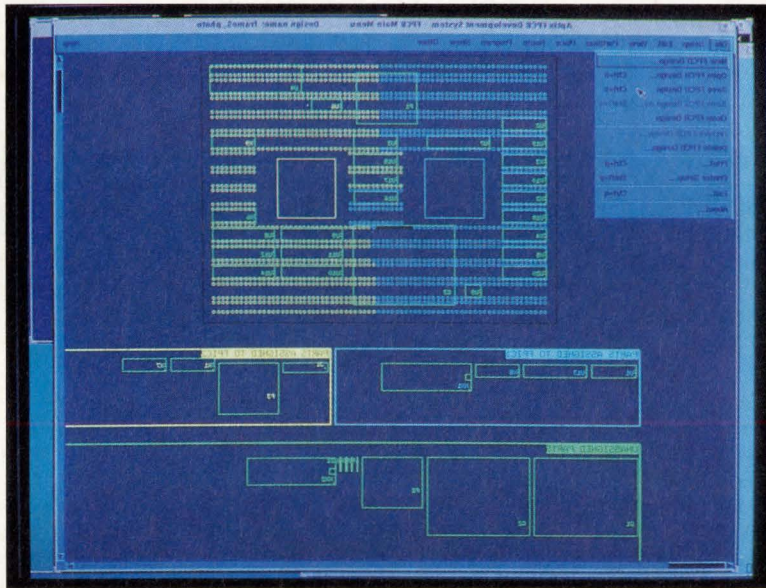

*The Aptix PC-based development system lets hardware prototypes be tested immediately instead of having you wire breadboards together. Computer-based wiring changes can optimize a design, and instant connection to logic analyzers is achievable without having to connect dozens of microclips in hard-to-reach places.*

can predict crosstalk, ground inductance, power factors, backplane effects, transmission line effects, ringing, and over- and undershoot. Of special importance when working with high-speed circuits and mixed analog and digital circuits, XTK's unique abilities can be invaluable to uncover layout-induced errors on critical system designs before going to production.

Similar to XTK is the Contec CAE (CCAIE) simulator from Contec Microelectronics USA (San Jose, CA), which supports high-speed digital and analog PCB, MCM and ASIC designs. Along with the company's ContecSpice simulator, this software predicts voltage spikes, crosstalk, impedance mismatch, and reflections in layout of signal traces. In addition, high-frequency clock distribution trees associated with signal skews

## PC-BASED CAE/CAD

development include PROM programmers, in-circuit emulators, logic analyzers, ROM emulators, assemblers, compilers, and debuggers. Dozens of companies offer PROM programmers; some noteworthy ones are Data I/O, Logical Devices, Quantec Systems, Stag, and Storey Systems. Likewise, more than a dozen companies provide in-circuit emulators for microprocessors, including American Automation, Hewlett-Packard, Huntsville Microsystems, Kontron, Metalink, Nohau, Orion, Signum Systems, and Sophia Systems. Popular micros supported by these companies are from AMD, Intel, Motorola, National, NEC, Philips/Signetics, Texas Instruments, and Zilog.

### Developing DSP, too

One area especially well-suited to the number-crunching abilities of the PC is DSP applications. Digital circuits have demonstrated their effectiveness for dealing with analog functions in many applications, and DSP is a rapidly growing area absorbing more analog designs every day. While typically more expensive to implement than analog, DSP provides many key benefits, making it the ideal choice for many of today's signal processing tasks. With the introduction of DSP chips from vendors such as AT&T, Analog Devices, Motorola, Star, TI, and Zoran, to name a few, designs once in the realm of hardcore analog designers

using discrete analog components are now found in the digital designer's arena.

One recent offering targeted at the emerging multimedia market comes from AT&T (Allentown, PA), which provides development hardware and software for its video compression/expansion chip sets for JPEG and MPEG. Another is from Analog Devices (Wilmington, MA), which makes available the EZ-Lab development board and software to support the company's DSP chips.

Perhaps the most impressive PC-based DSP development system comes from Star Semiconductor (Warren, NJ), which manufactures the Sproc DSP chip containing four processors. It handles data up to 24 bits wide through two serial inputs, two serial outputs, a bidirectional parallel port, and an independent probe port. Unique to this system is your ability to design and test a DSP application without having to write a line of code. SprocLab software transforms your schematic into code that's directly executable by the Sproc chip and can be tested on an evaluation board that comes with the development system.

There are many other engineering areas where the PC is beginning to find extensive use. To detail these fringe technologies would fill an encyclopedia. Among such applications are neural computing, mechanical design and drafting tools, reliability software, and CASE tools. ■

For more information about the technologies, products or companies mentioned in this article, call or circle the appropriate number on the Reader Inquiry Card.

<b>Accel Technologies</b> (619) 695-2000	Circle 257	<b>MicroSim</b> (714) 770-3022	Circle 271
<b>Aldec</b> (805) 499-6867	Circle 258	<b>MINC</b> (719) 590-1155	Circle 272
<b>Altera</b> (408) 984-2800	Circle 259	<b>Omatron</b> (214) 231-5167	Circle 273
<b>Analog Devices</b> (617) 329-4700	Circle 260	<b>OrCAD Systems</b> (503) 690-9881	Circle 274
<b>AT&amp;T</b> (800) 372-2447	Circle 261	<b>P-CAD</b> (408) 971-1300	Circle 275
<b>Contec Microelectronics</b> (408) 434-6767	Circle 262	<b>Quad Designs</b> (805) 988-8250	Circle 276
<b>Data I/O</b> (206) 881-6444	Circle 263	<b>QuickLogic</b> (408) 987-2000	Circle 277
<b>Dazix/Intergraph</b> (205) 730-2000	Circle 264	<b>Racal-Redac</b> (201) 848-8000	Circle 278
<b>Etron Radio Frequency Enterprises</b> (714) 594-8741	Circle 265	<b>Signetics</b> (408) 991-2000	Circle 279
<b>Exemplar Logic</b> (510) 849-0937	Circle 266	<b>Star Semiconductor</b> (908) 647-9400	Circle 280
<b>Futurenet</b> (206) 881-6444	Circle 267	<b>Tesoft</b> (404) 751-9785	Circle 281
<b>Intusoft</b> (510) 833-9100	Circle 268	<b>Viewlogic Systems</b> (508) 480-0881	Circle 282
<b>Lattice Semiconductor</b> (503) 681-0118	Circle 269	<b>Visionics</b> (408) 562-0123	Circle 283
<b>Logical Devices</b> (800) 331-7766	Circle 270	<b>Xilinx</b> (408) 559-7778	Circle 284

## Post Script

**W**hat's ahead for PCs in the engineering world? While 286s are still out there, the platform of choice today is the 386. The 486, with on-chip math coprocessor and cache RAM, will probably replace the 386 over the next two years.

PS/2 and some clone manufacturers are relying on Micro Channel bus architecture, but the standard AT bus or the ISA bus remain more popular. Micro Channel is faster, making it better for networks, but engineers usually need faster processor speed, not faster bus speed. EISA is going to be the next bus standard, because it offers both Micro Channel speed and compatibility with AT-bus expansion cards.

Plagued with bugs and crashes, the multitasking OS/2 operating system never had a major impact on the engineering community. Instead, as noted in this article, the OS of choice is Windows. Windows already takes care of many device drivers and system interfaces, letting you concentrate on other things, like your job. For more demanding applications that can't afford the slow speed and high overhead of Windows, DOS will continue to be available.

A multitasking operating system that may give DOS a run for its money is Unix, which seems to be migrating down from larger machines and gaining popularity in the PC market. But Unix requires a great deal of RAM and disk space, and it's less easy to learn.

Apple is offering the Mac to the engineering community—and it has some attractive features, such as a multitasking OS, a powerful processor and an icon-based user interface. It lacks the third-part support of the IBM, though, and the latter will remain the mainstay for CAD/CAE engineers for years to come.



# THE DECSTATION 5000 SERIES. THE PERFECT RUNNING MATE FOR TEAMWORK.

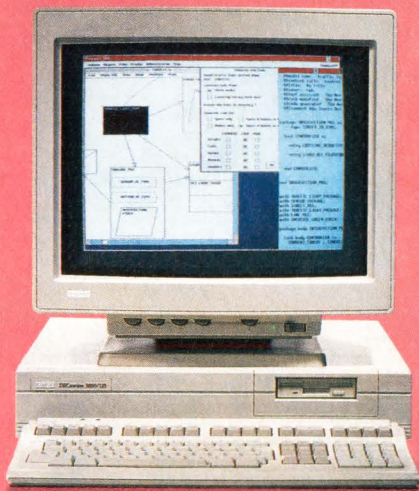

CASE solutions today demand more from the systems they run on. More power, more balanced performance, more commitment to open standards and, last but not least, more for your money.

Digital's DECstation™ 5000 Series provides all

that and more. Our UNIX®-based DECsystem™ family combines the CPU power, high-speed I/O and memory and the high-performance networking and tools you need to get the highest productivity from your applications.

Plus, all members of our DECsystem family

are fully compatible with the Advanced Computing Environment (ACE) initiative. ACE compatibility protects your ULTRIX™ applications investment and lets you be part of the open environment of the 90's.

The DECstation 5000 Series. Count on it for CASE solutions

## TEAMWORK AND DIGITAL TEAM UP ON CASE

Cadre Technologies Inc.'s *Teamwork*® and Digital's DECstation 5000 Series provide the powerful combination you need for system and software development in an integrated Computer-Aided Software Engineering (CASE) environment. *Teamwork* offers a complete, multi-user development system that takes advantage of the

advanced-engineering, high-performance DECstation 5000 workstations. Because the architecture is both open and flexible, software developers can now maximize their productivity to ensure the overall success of the development system. For more information on *Teamwork*, call (401) 351-CASE.

© Digital Equipment Corporation 1992. The DIGITAL logo, DECsystem, DECstation, and ULTRIX are trademarks of Digital Equipment Corporation. UNIX is a registered trademark of UNIX System Laboratories, Inc. in the USA and other countries. *Teamwork* is a registered trademark of Cadre Technologies Inc.

ADVANCED COMPUTING ENVIRONMENT

**digital**™

# DIGITAL. THE OPEN ADVANTAGE.

# True portables are totally off the wall.

No outlets. No rechargers. No reliance on AC whatsoever. That's true portability. It's what the world is coming to. And it runs on easy-to-replace primary batteries. The next generation promises even smaller, lighter weight, more convenient portables. That depends on you, and you can depend on us.

Duracell is the primary source for primary power. We offer you a world of technical expertise and marketing experience in developing powerful solutions for computers, cellular phones and more. Let us help you

select a primary battery system from our broad line that includes alkaline and high power lithium manganese dioxide batteries.

Call us for application-specific data, design-in assistance, or just more information. Our OEM hotline number is (800) 544-5454, Ext. 3281. Or fax us at (203) 791-3273.

True portability is the cutting edge. And it's in your power.

**DURACELL®**  
PORTABILITY IS PRIMARY

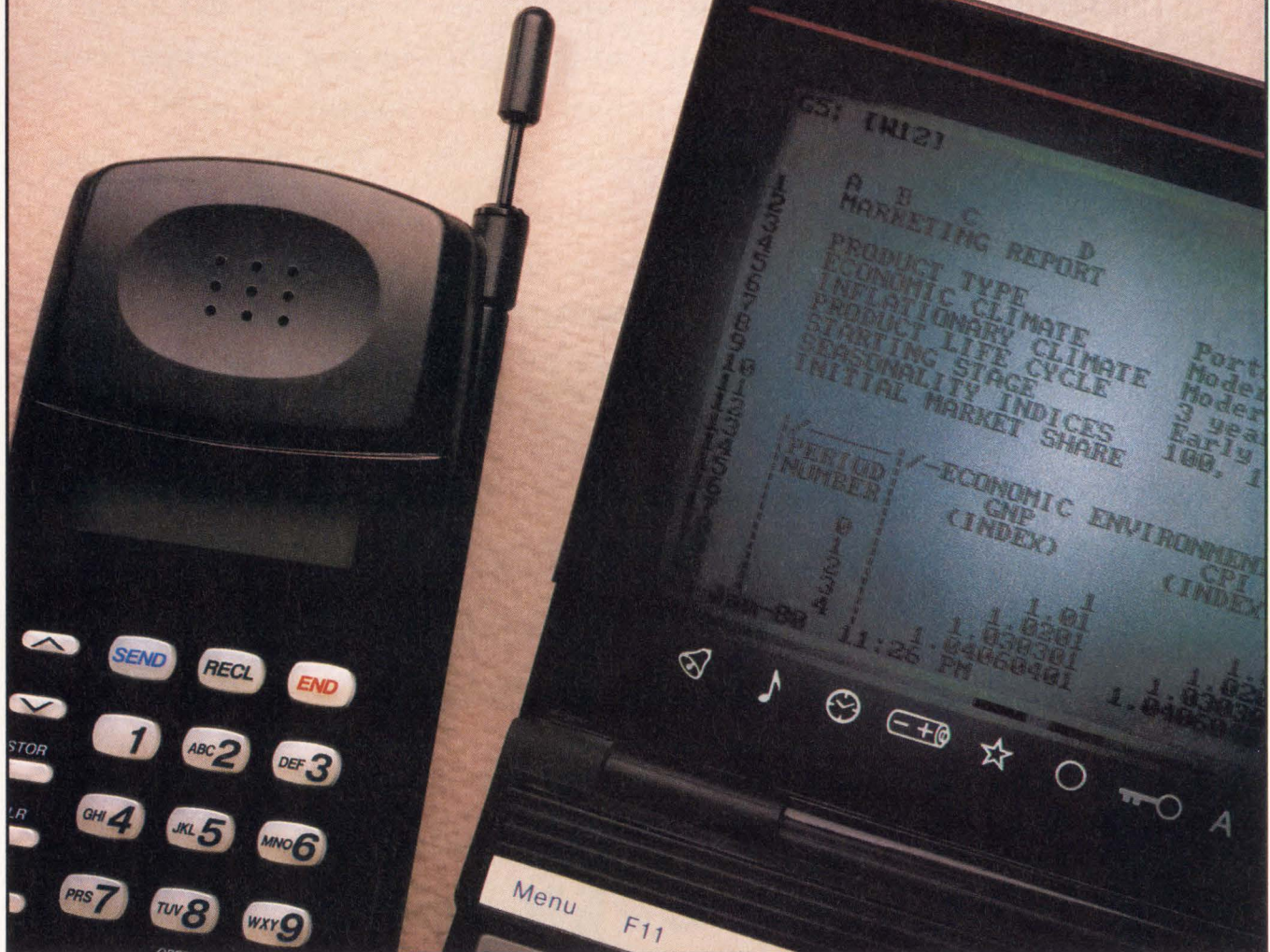



# The fastest single-shot scope in the west



*The HP 54700 series design team. Standing, left to right: Allen Montijo, circuit/system design engineer for hardware and software; Pat Byrne, R&D section manager for chip development; Mike McTigue, R&D project manager for plug-ins; John Scharrer, R&D section manager for high-performance oscilloscopes; Mike Manley, manufacturing manager for high-performance oscilloscopes; and Dave Long, R&D project manager for software. Seated, left to right: John Campbell, mechanical engineer for system box design; Dale Walz, thick-film hybrid R&D engineer; Tom Uhling, probe development engineer; and Ken Rush, R&D project manager.*

**T**he new HP 54700 series digitizing oscilloscope from Hewlett-Packard (Colorado Springs, CO) represents an absolute triumph of mixed-signal design. Not only did the design call for custom attenuators, a new converter technology, thick-film hybrid mixed-signal circuitry, and several analog and digital custom IC designs, but it also required the development of a high-speed real-time computer system and display processor to boot. It's hardly surprising that the project represented the cumulative effort of several divisions of the company.

The company set the goal of designing a single-shot digitizing box, according to John Scharrer, R&D section manager for high-performance oscilloscopes, to outperform the fastest analog storage oscilloscopes available. To accomplish this, the new design needed to achieve 1-GHz-bandwidth single-shot capability—meaning a sampling rate of no less than 4 Gsamples/s.

Potential customers for the new instrument were pushing clock rates beyond 40 or 50 MHz in their designs—running into difficult signal integrity problems on their printed circuit boards (PCBs) and in their multichip modules (MCMs). They needed the ability to probe signals unobtrusively in searching for problems such as ground bounce, undershoot and overshoot—problems that sometimes occurred infrequently.

Dave Wilson, Senior Editor

## DESIGN STRATEGIES: INSTRUMENTATION

"We wanted to let designers trigger on a signal and then look back in negative time to observe and characterize those rarely occurring, very narrow pulses," Scharrer says.

When the project was begun, there wasn't much off-the-shelf technology to help the HP design team build such a product. "Whether it was the mechanical box, the software design, the digitizer, or the

probes, a number of plug-in modules used for attenuation and amplification, a conversion subsystem, a processing and display subsystem, and a custom Sony display.

Tom Uhling, designer of the HP 54701A active probe, admits that probes have traditionally frustrated many scope users. That's because the probe can change the characteristics of the circuit being measured

be destroyed when inadvertently exposed to 100-V sources, rather than the 5 V they were designed to work with. The HP probe, on the other hand, is very robust. "It's specified to withstand 200-V ac but we've tested it to 600-V ac," Uhling claims.

Inside the probe, the input signal is routed to a 10:1 attenuator; from there it's fed to a high-frequency amplifier comprising four microwave bipolar transistors. The output from the amplifier is then fed to a 50  $\Omega$  cable. At the same time it's sensed and fed back to the amplifier through an op amp. "Radio frequency amplifiers typically don't have good dc performance. They drift unless you build an op amp in the feedback path to compensate for it," says Uhling. That feedback circuit also solves the problem of "thermal tails" on the RF amplifier. Thermal tails occur as a result of the heating that occurs when a pulse is fed into an amplifier. A pulse causes the temperature of the transistor junctions to rise and hence changes the bias conditions of the amplifier—the transistors cool off as heat dissipates through the ceramic substrate. Left uncompensated, such an effect would cause an erroneous signal to be sent into the attenuator section of the scope.

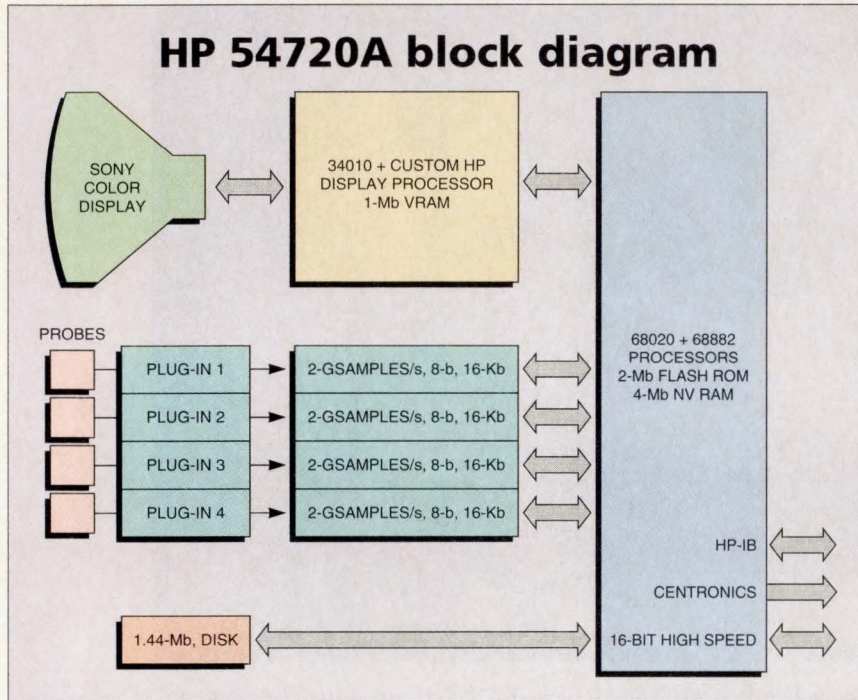

*Inside the 54720A digital scope. High-speed signals are attenuated and amplified by dedicated custom plug-in modules, then fed to a custom hybrid converter where they are digitized before being sent to a real-time custom computer for analysis and display.*

probe, we designed everything from scratch," Scharrer adds.

Prior to the development of the new HP box, high-performance oscilloscopes were analog in nature. "Our vision," says R&D project manager Ken Rush, "was to replace the analog system with a digital machine." Using digital techniques, the new scope could capture, analyze and display data at high speed. So as not to disappoint designers accustomed to interpreting data displayed on an analog scope, the HP design team even went so far as to make the display "look and feel" like its analog counterpart.

### Probing the problem

Conceptually, the new oscilloscope was built around five major functional elements that were designed concurrently. They comprised

by loading it, so designers have no idea whether they're seeing a "true" signal or not.

Typically, active probes have been designed in the past using FET technology. But to maintain a high input impedance and lower input capacitance, especially important when dealing with high-frequency signals, HP decided to use bipolar technology instead. The results were worth it. HP's new HP 54701A active probe offers some impressive specs—0.6-pF input capacitance and 100 k $\Omega$  input resistance with up to 2.5 GHz of bandwidth.

Bipolar transistors offered other benefits to Uhling as well. "They're more robust than FETs," he says. FETs are easily damaged by electrostatic discharge and it's common for probes based on FET technology to

### Functionally modular

Plug-in modules perform signal conditioning functions such as attenuation and amplification. An important part of the new scope, they're accommodated by four different plug-in slots in the box.

All of the plug-in modules can be inserted and withdrawn from the scope while it's under power. Although the ability to reconfigure the scope without shutting off the power is clearly of benefit to the customer, the HP team wasn't always sure of the merits of the idea. "Initially, we were going to put a warning on the front panel not to remove the modules while the box was running," says Scharrer. "We even designed a front panel with warnings on it. Then we realized we weren't solving the customer's problems."

According to Mike McTigue, R&D project manager for the plug-ins, the need for them was driven by customer demand. "Some customers want high impedance on the input so that they can use standard passive—rather than active—probes. Some of them have high bandwidth requirements, while others need ac

# Pushing the Edge of Capacity...

# 1.65 GB in a 5.25-inch Form Factor.

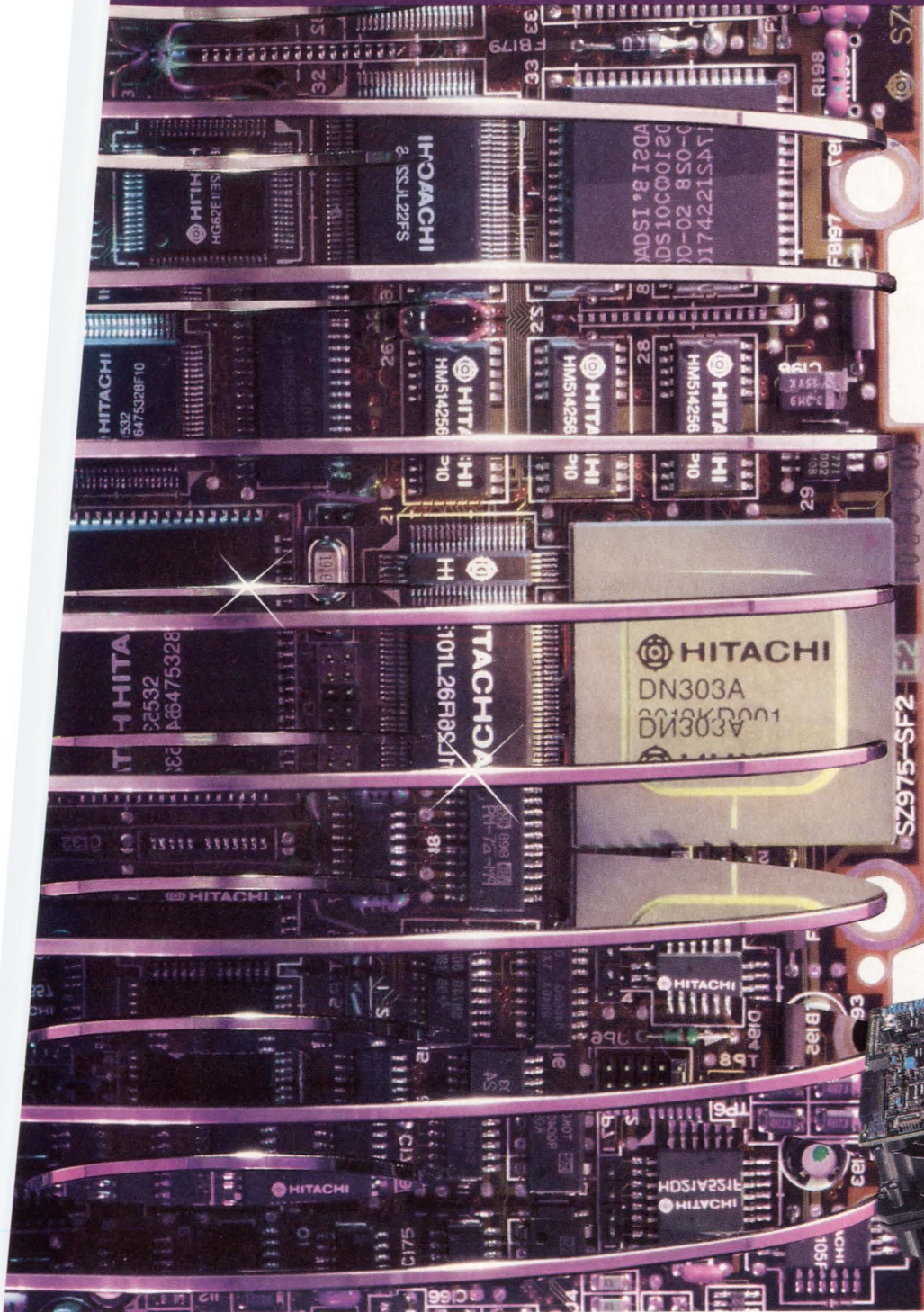

## Edge-to-Edge Performance

The DK516C-16 uses Hitachi's advanced proprietary technology to deliver 1.65 GB of capacity and a fast 13.5 ms average access time.

Its SCSI interface provides a maximum data transfer rate of 5.0 Mbytes/sec (synchronous), with a 256 Kbyte data buffer and read look-ahead cache.

Or, if you have an ESDI application, look into Hitachi's 1.54 GB DK516-15 with a 14 ms average seek time and a 2.75 MB/sec data transfer rate.

## Edge-to-Edge Quality

Choose the DK516 and you get a drive backed by the quality and reliability of Hitachi—a \$54 billion company. Unlike other drive manufacturers, we design, build, and test all key components in-house.

For more information about the DK516, or any Hitachi disk drive, call 1-800-HITACHI.

**Hitachi America, Ltd.**  
Computer Division, MS500  
Hitachi Plaza  
2000 Sierra Point Parkway  
Brisbane, CA 94005-1819



# HITACHI®

Our Standards Set Standards

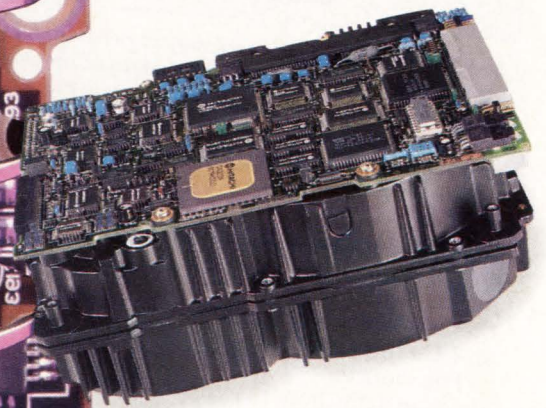

## Authorized Distributors:

**CONSAN 612-949-0053**  
(IA, IL, IN, KS, KY, MI, MN, MO, ND,  
NE, OH, Pittsburgh, PA, SD, WI)

**GENTRY ASSOCIATES**  
800-877-2225 (AL, D.C., FL,  
GA, LA, MD, MS, NC, SC, TN, VA)

**R SQUARED 800-777-3478**  
(AZ, CA, CO, NM, OR, UT, WA, WY)

**SIGNAL 800-228-8781**  
(CT, MA, ME, NH, RI, VT)

**HITACHI (CANADIAN),  
LTD. 416-826-4100** (Canada)

**SPECIALIZED SYSTEMS**  
TECHNOLOGY 800-688-8993  
(AR, LA, OK, TX)

CIRCLE NO. 54

IDA

INSTANT DATA ACCESS (IDA) DIAL (617) 494-8338 DOCUMENT NO. 1034

## DESIGN STRATEGIES: INSTRUMENTATION

coupling so they can look at small signals riding on a lot of dc. Others need to perform extensive filtering—maybe they have a lot of high-frequency noise riding on the signal and need to filter it out,” he says. To meet this broad set of requirements, HP developed several plug-in modules for different applications.

Prospective customers were also interested in interleaving the plug-in modules to increase the single-shot bandwidth of the signal that can be measured. “A plug-in is a

is the HP 54721A. A two-wide plug-in, it accommodates two channels of 1-GHz, single-shot simultaneous bandwidth and has 4 Gsamples/s capability. “This is the plug-in that lets us replace the analog architecture of the past. It’s the highest bandwidth single-shot channel you can buy,” says McTigue.

The most critical parameter was the timing of the two outputs from the plug-in, which had to be routed to the two A-D converters. The design team had to achieve better than

subsystem was to achieve a sample rate four times as great as on its previous generation of instruments. But, while HP wanted to make a 4:1 leap in sample rate, it had to do so using only a 2:1 improvement in IC process technology. To pull it off, the analog subsystem designers rethought the whole architecture used in the conversion process.

A new architecture, called sample-and-filter, was critical to the success of the project. It replaces and better the industry-standard methodologies of sample-and-hold or track-and-hold. “Conceptually,” says Pat Byrne, R&D section manager for chip development, “the sample-and-filter subsystem comprises a sampler, four filters and two dual A-D converters, as well as memory.” All of these items were designed and manufactured by HP.

The sampler is a 500-Msample/s bipolar IC. Interleaving the four samplers in time achieves a 2-GHz sample rate. The low-pass filters are printed LC (inductance-capacitance) ladders networked on thick film. The filter response is matched to the sample rate to minimize noise and intersymbol interference. Digitization is carried out by two dual 500-MHz silicon bipolar A-Ds. Interleaving the voltage of the two 7-bit A-Ds results in a resolution of 8 bits. Data is stored in two 4k × 16-bit 500-MHz fast-in slow-out (FISO) CMOS memory devices.

All the custom devices designed for the sample-and-filter subsystem are packaged on thick film. Indeed, the design itself couldn’t have been realized without such a thick-film package, because signal integrity would have been lost at the interfaces between the devices.

### Computer design was key

“The goal of the computer subsystem is to display a picture of the signal, while giving the impression that the signal being probed is tied directly to the screen,” says Dave Long, R&D project manager for software. That meant getting 250,000 to 500,000 waveform data samples onto the screen every second. “The computer has about two microseconds to process each point,” Long adds.

To do the job, HP built the scope’s computer hardware around a 16-MHz Motorola 68020/68882 combination, a Texas Instruments 34010 graphics display processor, a lot of custom specialized hardware to as-

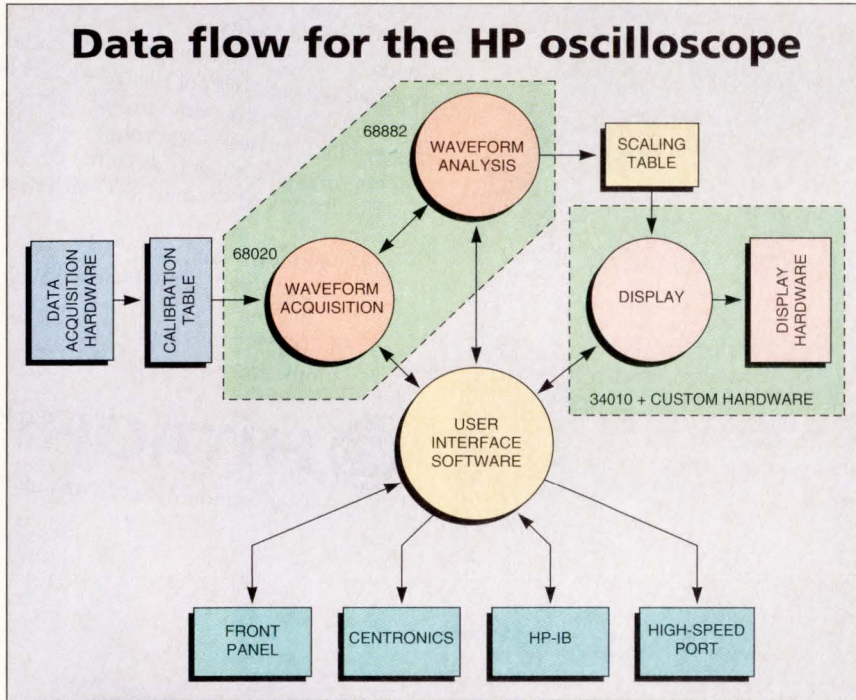

*Dedicated hardware was necessary to get system throughput to an acceptable performance level. The acquisition and analysis of the waveforms are tightly coupled processes—the 68020 is used predominantly in the acquisition process while the analysis software makes heavy use of the 68882. Dedicated hardware was built to handle calibration and scaling functions, as well as to take care of variable persistence.*

way to interleave input signals to obtain higher sample rates,” according to McTigue. “If you interleave them, you can get  $2 \times 2$  Gsamples/s, or 4 Gsamples/s.”

The concept of plug-in modules also had some benefits for the scope’s designer. “If we didn’t use modules, we would have to put microwave switching back in the frame of the scope, and that would have been more expensive,” adds McTigue.

HP debuted a number of plug-in modules when the company introduced the new scope. But the plug-in that permits access to the highest digitizing rate—and the one that was the most challenging to the design team—

1 ps of alignment between the signals. “This plug-in takes a 50- $\Omega$  input signal, runs it through a microwave attenuator, then puts it through an internal amplifier that drives two vertical 50- $\Omega$  signal channels and one 50- $\Omega$  trigger channel. All three outputs have a bandwidth better than 1 GHz, and a timing alignment between the vertical channels of better than 1 picosecond,” McTigue says. “That took some doing.”

### A new converter architecture

After attenuation and amplification, the signal must be converted into digital form prior to processing and display. HP’s goal on the converter

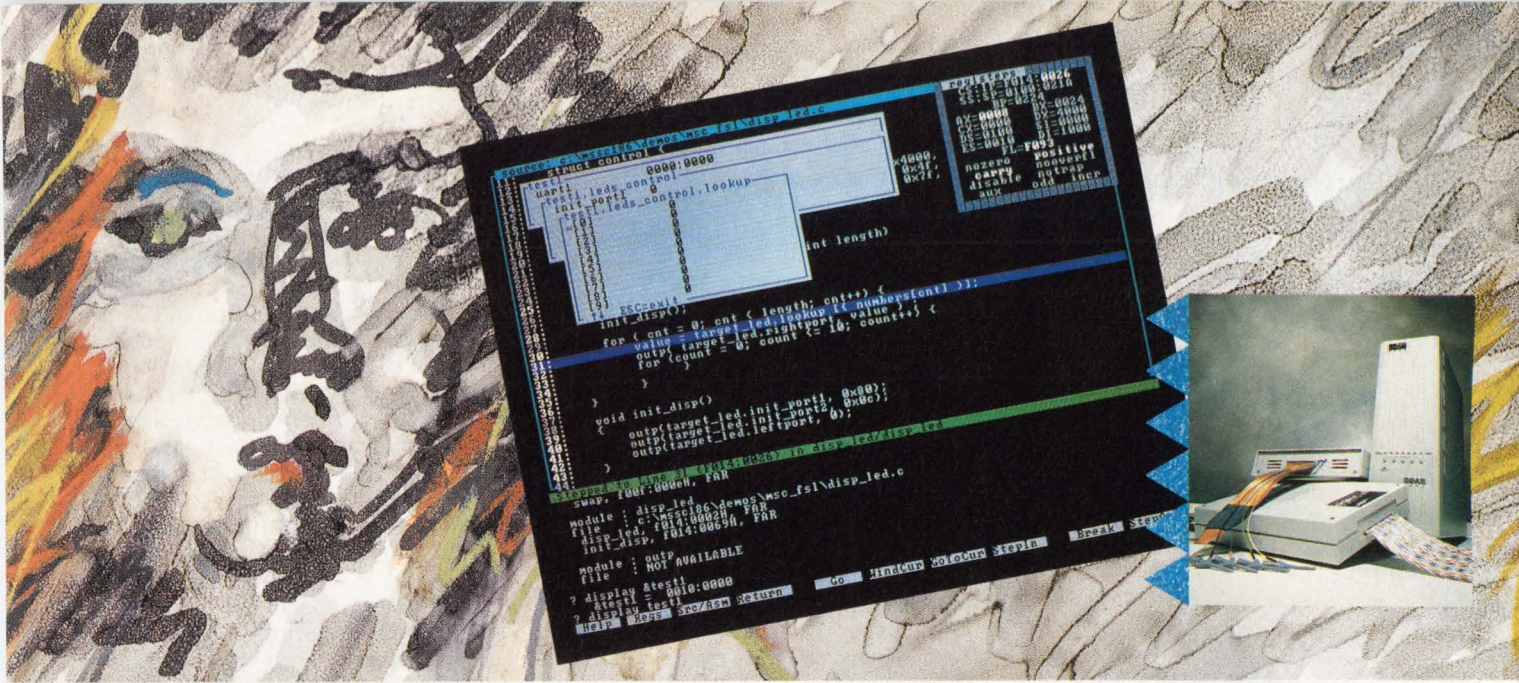

# Power Debugging ... for Real-Time Targets

## SOPHIA EMULATORS SUPPORT

### INTEL

80C86/88	10 MHz
80C186/C188	20 MHz
80286	25 MHz
80386	25 MHz
80386SX	16 MHz

### MOTOROLA

68000/10/12	16 MHz
68020	20 MHz

### NEC

V20/V30	16 MHz
V40/V50	10 MHz
V25	16 MHz
V33	16 MHz
V53	16 MHz
86/V	16 MHz

... plus processors from  
AMD, Hitachi, Mitsubishi,  
Rockwell, Zilog.

Do you need to debug a real-time embedded system? Do you use C along with assembly language?

Our emulation systems can help you complete your project faster.

### Real-Time Target Control

- Emulate without stealing target resources or adding wait states.
- Step through your actual source code, comments and all.
- Choose from many popular compilers.
- View code, registers, data, and commands all at once with our windowed interface.
- Capture precise information using our powerful trace capabilities, including sequential triggers, all in real time.

- Use full symbolic debugging capabilities, including high-level trace.

### Real-Time Technical Support

- Experienced software and hardware engineers.
- Step-by-step troubleshooting assistance.
- 24-hour Bulletin Board for users. Upload problem software, questions. Download code fragments, new releases, examples.

Sophia Systems' emulators give you the *power* to debug your target in your environment. And we're continuing to expand our capabilities to match your processor and debugging needs.

Call and tell us about **your** target.

**Sophia**  
systems  
and Technology

1-800-824-9294

# The Toughest Gang in Town

Industrial,  
rugged  
QPC-7000

rackmount  
systems with 12 to  
20 slot backplanes, AC or  
DC power supplies, 286 to 486  
computing power, split backplanes  
and fault tolerant configurations.

Also available in 6 to 20 slot  
industrial bench-top models.

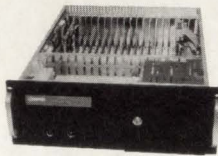

Panel mount,  
wall mount  
and transport-  
able card cages,  
4 to 10 slots, 286 to  
486 computing power  
for embedded process and quality  
control applications.

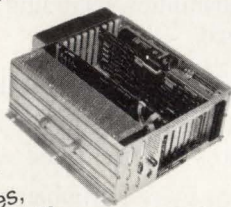

For immediate information, ask for  
our full line industrial computer  
system and data acquisition catalog.  
We are a full system manufacturer.

**QUALOGY**

109 Bonaventura Drive  
San Jose, CA 95134  
800-722-4976  
408-434-5200

CIRCLE NO. 56

## DESIGN STRATEGIES: INSTRUMENTATION

sist the processor, and the pSOS real-time operating system. This array of parts was chosen because it was consistent with code that HP's software engineers had written in the past.

With previous HP designs, the computer would be purchased off the shelf and software engineers hired to code it, but the HP 54700 project was different. "With the HP 54700, we did the software design first. We then optimized the hardware for the execution of the specific algorithms," says Long.

Customized hardware, for example, was employed to calibrate the data from the A-D converter. Since no converter is entirely linear, some points need to be corrected before being processed or displayed. To correct the nonlinearity errors, HP designed a hardware read-through table. When a sample is read out of the acquisition system, it's corrected as it passes through the table—and before the processor sees it. Another example of a custom assist is a hardware table used to scale graphics data after analysis but prior to display.

A two-processor solution was chosen after careful analysis showed that earlier HP oscilloscopes were spending up to 90 percent of their processing energy erasing old data points from the screen. "It's a complicated problem keeping track of where the points are, how long they have been there, and when they need to go away. We found that actually drawing data points took a lot of time and was a slow process too," says Long.

Although Long's team chose to use a Texas Instruments 34010 processor as the display processor, there were certain capabilities it lacked. One was the ability to handle gray-scale variable persistence. Variable persistence lets new data appear very bright on the screen, while at the same time older data is shown fading out in intensity.

The older analog scopes boasted this capability, and designers had developed a knack for interpreting the rate at which the signal faded away. Unfortunately, since the 34010 didn't have the requisite features to handle it, HP's design team emulated the phosphor persistence of the analog design by building a dedicated custom processor just for that purpose.

To discover the features that de-

signers preferred in a scope interface, HP wrote an X Windows application that modeled the look of the scope on the screen of a workstation. Eventually, this X Windows application, used as a simulation for the front panel, was turned into a development environment. "We wrote a lot of the code on the workstation in ANSI C and ran it on the workstation. Once we finished, we were able to recompile on the actual target and have it up and running in a day or two," says Long.

"After we had finalized the user interface on the scope, we then took the box out to users and made some final changes based on more user input. At the beginning of the project, we weren't sure if we would gain anything or not from the modeling process, but in the end it was worth it," Long concludes.

### Cost of ownership

Ken Rush says that when HP started the project, cost-of-ownership issues were carefully analyzed. At just under \$30,000, the price of the scope isn't unreasonable, but it's still high enough to make ownership prohibitive. "When a scope breaks, the customer has traditionally paid about \$100 per hour for labor to get it fixed. Although we can isolate a bad board and swap in a new one in 10 minutes, it might take another three hours for the technician to recalibrate the instrument," says Rush. To circumvent that expensive scenario, Rush's engineering team decided to incorporate the calibration standards right into the instrument itself. "We designed the whole instrument so that there are no potentiometers inside it. You don't have to take the cover off and tweak things to calibrate it," he boasts.

A similar problem arose over updating or changing software internal to the instrument. Usually, UVROMs or UVPROMs are used in HP equipment for firmware storage. While reliable, problems can arise should the software ever need to be changed or modified—the instrument must then be taken apart and new ROMs inserted. "That's a pain in the neck," says Rush, "so on this machine, we installed flash EEPROM so that we can download code via a disk drive in the system." According to Rush, flash EEPROMs were chosen because they are very reliable in a hostile environment. ■

# 16 lines, No waiting.

Your application is first in line with the MVC 16-line Async Commux. It's got processing capacity to spare, thanks to a 16 MIPS RISC, so system power goes to your users — not I/O.

Character processing and buffering is managed on-board by our RISC, so driver calls and host overhead are kept to a minimum. All 16 lines can operate at 38.4 Kbaud. That's over 61,000 characters per second throughput, double the rate of other VMEbus async controllers.

The MVC's advanced features benefit both the integrator and programmer. Port and VMEbus parameters are soft-configured and set line-by-line. Modem control is standard. Full software support is also included,

along with diagnostics and a Streams driver.

Advanced memory architecture and high-speed buffering eliminate overruns and port domination. Memory is expandable from 128KB to 1MB, so the MVC handles today's requirements and future application needs.

With over 11 years experience producing advanced storage, communications and memory products, Macrolink delivers the powerful and flexible MVC in 8 and 16 line configurations. Call us today. We won't keep you waiting.

Macrolink Inc.,  
1500 North Kellogg Drive,  
Anaheim, California 92807.  
Phone (714) 777-8800,  
FAX (714) 777-8807.

**macrolink® inc.**

CIRCLE NO. 57

INSTANT DATA ACCESS (IDA)

DIAL (617) 494-8338 DOCUMENT NO. 1037

*Mix & match I/O  
panels feature  
DB25 or RJ-45  
connectors*

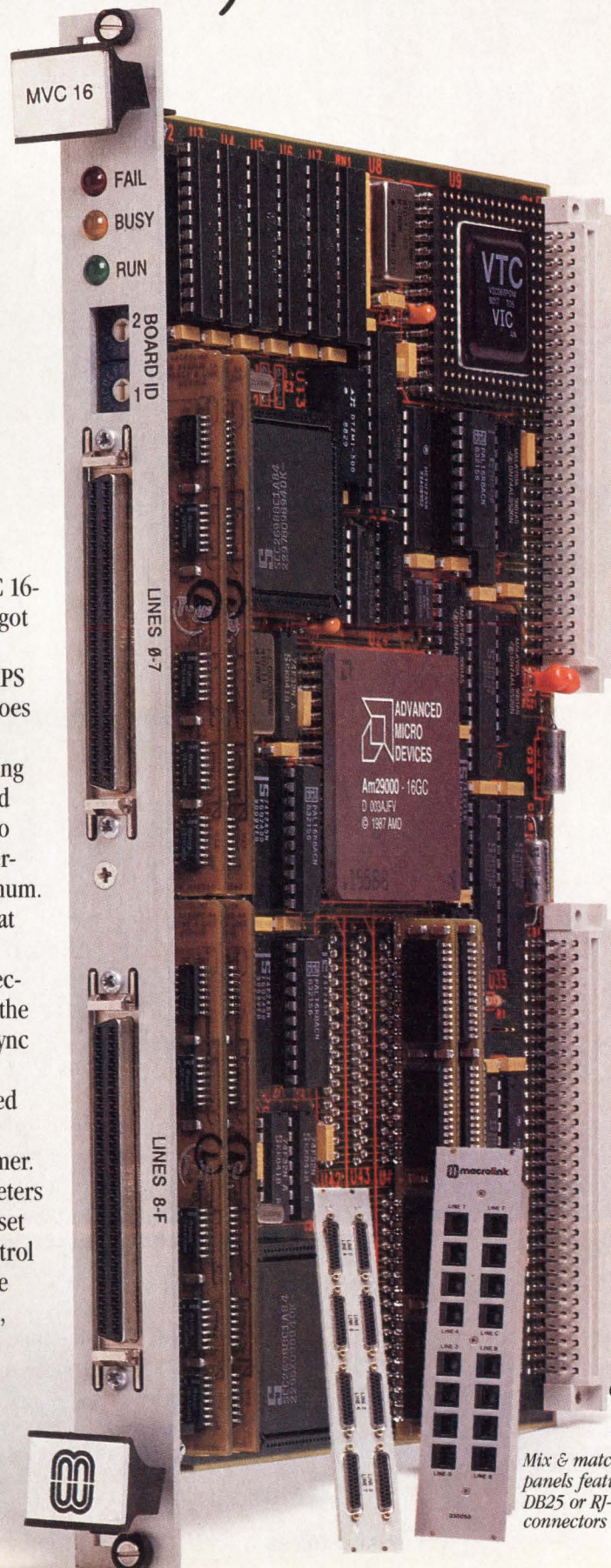



## You Can Try Building Your Own Real-Time Operating System,

Building your own operating system for a real-time application can cost you up to a year in expensive programming time. And lost business opportunities. In a fast-moving market, it simply doesn't make sense to build. Not when VxWorks™ from Wind River Systems lets you move right in.

VxWorks gives you all the components and tools you need to start developing applications immediately. Which cuts your

HOSTS	TARGETS
Sun	68K
HP	SPARC
DEC	MIPS
IBM	i960

VxWorks supports multiple platforms.

costs dramatically. And because VxWorks offers a more full-featured development platform than any other off-the-shelf operating system, it gets your product to market

## Or You Can Feel Right At Home With VxWorks.



faster. It's the one true turn-key solution, fully compatible with industry standards right out of the box.

Wind River Systems pioneered off-the-shelf high-speed UNIX® networking for real-time applications. And VxWorks still leads with the most complete, robust networking available. The lean, efficient wind™ kernel gives it unsurpassed multi-tasking speed and functionality.

So before you invest the time and money trying to build your own real-time operating system from the ground up, find out more about VxWorks. And feel right at home from day one.

**1-800-677-1586.**

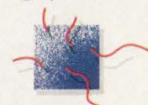

WIND RIVER  
SYSTEMS

Real-Time Solutions for The Real World



SOFTWARE & DEVELOPMENT TOOLS

# What's real in real-time operating systems?

Jeffrey Child, Associate Editor

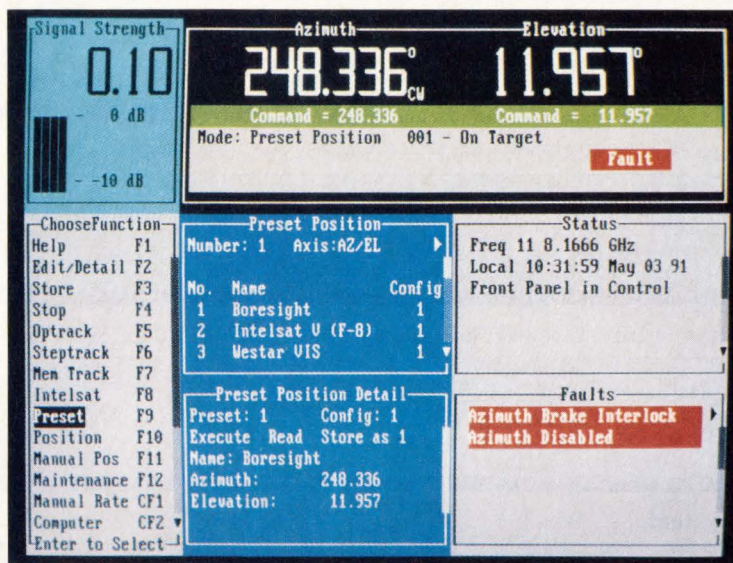

Designers at Radiation Systems selected the QNX real-time operating system from Quantum Software Systems for an antenna controller system that controls a 7,500-ton, 100-m radio telescope. Using the QNX development environment, the software development team averaged between 2.5 and 3 lines of executable code per hour.

One of the most critical “build or buy” decisions facing real-time system designers is whether to purchase an off-the-shelf real-time operating system (OS) or make your own. If you opt for the first alternative, the current selection of off-the-shelf real-time kernels and OSs ranges from small, fast kernels to full-blown, Unix-like operating systems with a variety of graphics and networking support features. Because no one vendor supports all microprocessor targets and host platforms, you may need to use products from several different vendors to perform separate functions in the same real-time system.

Hoping to entice designers away from roll-your-own solutions, today's real-time software vendors generally offer more than just a kernel. Most provide complete OS packages including a real-time kernel, input/output executive, file management executive, language interface libraries, hardware interface support, debugger, network management support, and cross-platform compilers. These packages are usually sold for a development system price per number of users. Often the kernel can be purchased at quantity prices for embedding into the final design.

The reasons for choosing a real-time OS or kernel and buying off-the-shelf real-time software can be confusing. A study done last fall by consulting firm International Data Corporation (Framingham, MA) found that most real-time software

vendors don't actively seek to specialize by application or industry, although many have a de facto focus. According to the study, key differentiators among vendors today are development tools, operating system response time (performance), and relationship to Unix.

One cause for confusion in the real-time OS market is the overuse of “context switch speed” as a way of comparing performance. But as Stuart Schlitt, vice-president of marketing at Integrated Systems, software components group division, (Santa Clara, CA), points out, context switching speed isn't a very good metric for judging performance. “Context switch speed doesn't have anything to do with the performance of the kernel,” he says, “especially if it's a nested interrupt, and you're responding to the second interrupt.”

Because customers ask for it, Integrated Systems does provide context switch figures for its pSOS+ kernel, part of the pSOS+ real-time integrated OS development environment. The company calculates the number using two other metrics it believes are more relevant to overall performance. One is the interrupt response time, which is defined as the greatest length of time that the kernel turns off interrupts. Using this metric pSOS+ yields a 6 μs response time on a 25-MHz 68020.

The other metric used is the time it takes a waiting task to begin to run. “We publish a series of numbers which document how long it takes to make a system call,” says Schlitt.

“[Using those numbers] you could figure out how long it takes to run under different situations.” In a typical situation, a high-priority task may be blocked at a message queue, waiting for a message to come in. When an interrupt comes in, an interrupt handler sends a message to the queue where the task is waiting, causing it to preempt a low-priority task. What's measured is the time it takes to send the message, and also the time it takes for the task awaiting that message to receive it and ready itself to indicate that the task is running. That number is usually referred to as task latency time. “Out of those numbers we extract something called a context switch time, but only because people keep asking us for that,” adds Schlitt.

## Posix a plus

For a long time, both vendors and users of real-time OSs have seen a need for some kind of standard. The most successful attempt at this so far is the IEEE Posix standard. For designers familiar with Unix, compliance won't be a problem, because Posix is based on Unix. The other benefit of Posix is flexibility. It can ease the task of switching an R3000 to an R4000-based design, or from MIPS to Sparc, or to another vendor's Posix-compliant real-time OS.

As the chart shows, a significant percentage of real-time OS vendors have Posix 1003.1 and 1003.4 in their plans. Many are waiting to see the final draft before making any changes in their products.

**PRODUCT FOCUS : REAL-TIME KERNELS AND OSs (32-bit)**

Model name	Target processor	Platform support	Network support	Graphics support	Interrupt latency	Posix compliance (IEEE)	I/O and file systems features	Kernel-only price (Qty 100)/development environment price
<b>Accelerated Technology</b> PO Box 850245, Mobile, AL 36685 (205) 661-5770								<b>Circle 301</b>
NucleusRTX	68XXX, 80X86, MIPS, Sparclite, i960, 29000, and several DSPs	—	—	Metagraphics	0.6 $\mu$ s, 25-MHz 29000	—	MS-DOS compatible	\$3,500-\$5,000/ \$495 (for PC)
<b>A.T. Barrett &amp; Associates</b> 11501 Chimney Rock, Suite R, Houston, TX 77035 (800) 525-4302								<b>Circle 302</b>
RTXC	680X0, 80386, 29000	PC	—	—	8 $\mu$ s, 33-MHz 80386	No	Optional DOS-compatible file system	\$2,995 (no royalty)/ Included
RTXC/MP	TMS320CX0, T8XX transputer	PC	—	Optional graphics server	6 $\mu$ s, 25-MHz T800	No	—	\$12,900 (no royalty)/ Included
<b>Byte-BOS Integrated Systems</b> PO Box 3067, Del Mar, CA 92014 (800) 788-7288								<b>Circle 303</b>
Byte-BOS	68XXX, 80386, 80486	—	—	—	8 $\mu$ s, 33-MHz 80386	—	Stream serial I/O libraries for "on chip" and external UARTS	\$995 (no royalty)/ —
<b>Diab Data</b> 323 Vintage Park Dr, Foster City, CA 94404 (415) 571-1700								<b>Circle 304</b>
D-NIX	680XX, 88100	Eltec, Aydin, Diab systems	ARPA, OSI, NFS, SNA	X Windows, Motif	50 $\mu$ s, 25-MHz 68030	1003.1	Unix file system	—/—
<b>Digital Equipment Corporation</b> 146 Main St, Maynard, MA 01754-2571 (508) 493-6717								<b>Circle 305</b>
DECcelx	68020, 68030, Lockheed STAR, Omnibyte VR3000	DECstations, DECsystems	TCP/IP, NFS, UDP, telnet, FTP, RPC	—	6 $\mu$ s, 25-MHz 68030	Selected 1003.1/1003.4 functions	I/O device drivers; RT11 and MS-DOS file system	\$528/\$2,563
VAXELN	VAX, rtVAX, MicroVAX	VAX/VMS	DECnet, TCP/IP	DECwindows, Motif	9-12 $\mu$ s, rtVAX	Partial 1003.1 and 1003.4	Sequential, buffered, direct access	\$502/\$874
<b>Emerge Systems</b> 114 6th Ave, Indialantic, FL 32903 (407) 723-0444								<b>Circle 306</b>
RTUX	680X0, 683XX, 88XXX	HP, Motorola, Sun	TCP/IP, ARCnet, Bitbus	X Windows	10 $\mu$ s	No	Unix-compatible; network accessible	\$300-\$500/—
<b>Encore Computer</b> 6901 West Sunrise Blvd, Fort Lauderdale, FL 33313 (800) 587-2900								<b>Circle 307</b>
$\mu$ MPX, $\mu$ ARTE	88X00	Encore 91, 93	TCP/IP, NFS	X Windows	20 $\mu$ s, 88x00	Yes	Buffered, sequential, direct	\$2,500/\$6,500
<b>Enea Data AB</b> Box 232, Nytorpsvagen 5 B, S-183 23 Taby, Sweden, +46 8 792 2500								<b>Circle 308</b>
OSE	680X0, 683XX, 80X86, Z180	Apollo, HP-9000, PC, Sun, VAX	TCP/IP, NFS, Internet and OSI protocols	—	—	Yes	Advanced I/O	\$16,000/ \$8,000-\$16,000
<b>Eurostart</b> PO Box 7722, 2433 Frances Dr, Loveland, CO 80537 (303) 669-5068								<b>Circle 309</b>
Exeloc	80x86	PC/AT	—	—	20 $\mu$ s	No	Drivers for digital/analog I/O, 16 serial lines; MS-DOS compatible	\$10/\$699 (25 licenses)
RTXDOS	80286, 80386, 80486	PC/AT	Novell	MS Windows	25 $\mu$ s	No	Drivers for digital/analog I/O, 32 parallel lines; MS-DOS compatible	\$125/\$4,950 (25 licenses)

Model name	Target processor	Platform support	Network support	Graphics support	Interrupt latency	Posix compliance (IEEE)	I/O and file systems features	Kernel-only price (Qty 100)/development environment price
<b>Eurostart</b> PO Box 7722, 2433 Frances Dr, Loveland, CO 80537 (303) 669-5068								<b>Circle 309</b>
RTXDOS-Lite	80286, 80386, 80486	PC/AT	Novell	Mosy MMI	25 $\mu$ s	No	Drivers for digital/analog I/O, 16 serial lines; MS-DOS compatible	\$15/\$1,499 (25 licenses)
MOSY-32	80386, 80486	PC/AT	Novell	Mosy MMI	20 $\mu$ s	Planned	Drivers for digital/analog I/O, 32 serial lines; MS-DOS compatible	\$145/\$6,450 (25 licenses)
<b>Eyring, Systems Software Division</b> 145 W 820 N, Provo, UT 84601 (801) 375-2434								<b>Circle 310</b>
PDOS v4.1, VMEPROM v4.1	68000 family	SunOS, VMS, MS-DOS, Unix, target	TCP/IP, Sockets, Link Level, UDP	GKS	3 $\mu$ s	Yes	Posix-compatible file system, contiguous files	\$55/—
<b>Forth</b> 11 N Sepulveda Blvd, Manhattan Beach, CA 90266 (310) 372-8493								<b>Circle 311</b>
cF32-68332/ $\mu$ SD	68332	PC	—	—	—	—	Serial, parallel	—/\$3,950
pF32-386/ $\mu$ SD	80386, 80486	PC	—	—	—	—	Standard PC I/O	\$1,495/—
<b>General Software</b> PO Box 2571, Redmond, WA 98073 (206) 391-4285								<b>Circle 312</b>
Embedded DOS	80X86	PC/XT/AT	Netware 286/ Netware 386	DOS graphics libraries	—	—	All DOS file I/O (fully re-entrant)	\$600/\$495 (unlimited users)
Booter Toolkit	80X86	PC/XT/AT	—	—	—	—	Sequential, random	—/\$149
<b>Industrial Programming</b> 100 Jericho Quadrangle, Jericho, NY 11753 (516) 938-6600								<b>Circle 313</b>
MTOS-UX	680X0, 88X00, 80X86, i860	Sun, HP, PC, DG, Motorola	TCP/IP	No	3 $\mu$ s, 20-MHz 88100	Planned	Multi-buffered, sequential MS-DOS compatible file system	\$5,000/\$200
<b>Integrated Systems, Software Components Group</b> 3260 Jay St, Santa Clara, CA 95054 (408) 980-1500								<b>Circle 314</b>
pSOS+	680X0, 68EC0X0, 683XX, i960, 80X86, 88100, 88110	PC, Sun 3, Sparc, HP, VAX/VMS, DECstation, IBM RS6000	TCP/IP, UDP, IP, tftp, NFS	X Windows	6 $\mu$ s, 25-MHz 68020 8 $\mu$ s, 16.7-MHz 80386	1003.14	User defined I/O; choice of MS-DOS or Unix file structure	—/—
<b>Intel</b> 5200 NE Elam Young Pkwy, Hillsboro, OR 97124 (800) 438-4769								<b>Circle 315</b>
iRMX for Windows	80386, 80486	PC	iNA ISO transport, MSnet	MS Windows	4 $\mu$ s, 50-MHz 80486	Partial 1003.1	Adjustable buffering w/overlapped I/O, disk caching & mirroring	\$150 (qty 1)/\$5,595
iRMX III	80386, 80486	PC	iNA ISO transport, MSnet	Via 279 RGI	4 $\mu$ s, 50-MHz 80486	Partial 1003.1	Same as above	\$180 (qty 1)/\$5,650
iRMK	80386, 80486	PC	—	—	4 $\mu$ s, 50-MHz 80486	Partial 1003.1	Posix I/O via companion Unix processor	\$1,500/\$1,500 per user
<b>JMI Software Consultants</b> 904 Sheble Ln, PO Box 481, Spring House, PA 19477 (215) 628-0840								<b>Circle 316</b>
C Executive	i960, i860, 80X86 family, 29000 and 68000 family, MIPS, Sparc, and others	DOS, Sun, VMS, Unix	—	—	7 $\mu$ s, 33-MHz i960CA, 19 $\mu$ s, 20-MHz 68030	Partial	Unix-style I/O; DOS system with buffered, random, and sequential I/O	\$70/\$2,500 (unlimited users)

**PRODUCT FOCUS: REAL-TIME KERNELS AND OSs (32-bit)**

Model name	Target processor	Platform support	Network support	Graphics support	Interrupt latency	Posix compliance (IEEE)	I/O and file systems features	Kernel-only price (Qty 100)/development environment price
<b>Kadak Products, Ltd.</b> 1847 W Broadway Ave, Vancouver, BC V6J 1Y5 (604) 734-2796								<b>Circle 317</b>
AMX386	80386, 80486	PC	No	No	22 $\mu$ s, 20-MHz 80386	No	No	\$4,000/Included
AMX68000	680X0, 683XX	PC	No	No	29 $\mu$ s, 12.5-MHz 68020	No	—	\$3,000/Included
<b>Lynx Real-Time Systems</b> 16780 Lark Ave, Los Gatos, CA 95030 (408) 354-7770								<b>Circle 318</b>
LynxOS	80X86, 680X0, i860, 88100, PA-RISC, 29000, Sparc 2, R3000, R6000	386 PC, OS/2, MVME147/167, Sun, DG, Okistation, Intel 860 station	TCP/IP, NFS	X Windows, Motif	10 $\mu$ s, 33-MHz 80386	1003.1, 1003.4 (draft 9), 1003.4a (draft 4)	File system functionally identical to Unix plus contiguous files	\$290-\$490/ \$1,495
<b>Micro Digital</b> 6402 Tulagi St, Cypress, CA 90630 (800) 366-2491								<b>Circle 319</b>
SMX	80X86	PC	Any DOS package	Any DOS package	15 $\mu$ s, 10-MHz 80188	No	Runs with DOS	\$1,995 (no royalty)/ Included
<b>Microware Systems</b> 1900 NW 114th St, Des Moines, IA 50325 (515) 224-1929								<b>Circle 320</b>
OS-9	680X0, 683XX	Sun 3, Sparcstation, HP9000, SGI, DOS, Delta, VAX	TCP/IP, NFS	X Windows, Rave	18 $\mu$ s, 33-MHz 68030	—	Unified, modular I/O system with pipe, sequential, disk, tape, X, etc.	\$51/\$1,250 per system
OS-9000	80X86, 680X0	OS-9000, Sparcstation, HP9000, SG Iris, DOS, Delta	TCP/IP, NFS	X Windows, Rave	18 $\mu$ s, 25-MHz 80386	—	Same as above	\$135/\$995 per system
<b>Modular Computer Systems</b> 1650 W McNab Rd, Ft Lauderdale, FL 33309 (305) 974-1380								<b>Circle 321</b>
REAL/IX	68030	REAL/STAR	TCP/IP, X.25	X Windows, Motif	5-105 $\mu$ s	—	Preallocated files, asynchronous and direct I/O, standard Unix	\$1,595/\$6,000 (unlimited users)
REAL/IX	88100, 88110	REAL/STAR	TCP/IP, NFS, FDDI, X.25	X Windows, Motif	20-160 $\mu$ s	1003.1 now, (.2 and .4 planned)	Same as above	\$1,595/\$6,000
<b>Motorola, Computer Group</b> 2900 South Diablo Way, Tempe, AZ 85282 (602) 438-3244								<b>Circle 322</b>
VMEexec	680X0, 88100	Delta	TCP/IP	Delta Windows, X-Lib	10 $\mu$ s	1003.13, 1003.4 planned	Real-time file system with contiguous files; Unix file system access	\$125/\$7,500
<b>Novell, Desktop Systems Group</b> 70 Garden Ct, Monterey, CA 93940 (408) 649-3896								<b>Circle 323</b>
FlexOS	80386	PC	TCP/IP, NetBIOS	Multitasking graphics environment	18 $\mu$ s, 25-MHz 80386	1003.1	Device-independent Unix model for device, pipe, and disk I/O	—/\$3,995
<b>Objective Systems</b> C.P. 265, Ville Mont-Royal, P. Quebec H3P 3C5 (514) 344-1674								<b>Circle 324</b>
Interactors C++	80X86	PC	SL/IP,UDP	No	4 $\mu$ s, 33-MHz 80486	No	Timer, RS-232, mouse and DOS files	\$495 (no royalty)/ \$4,990

Model name	Target processor	Platform support	Network support	Graphics support	Interrupt latency	Posix compliance (IEEE)	I/O and file systems features	Kernel-only price (Qty 100)/development environment price
<b>Precise Software Technologies</b> 301 Moodie Dr, Suite 308, Nepean, Ontario K2A 3Z5 (613) 596-2251 <b>Circle 325</b>								
Precise/MPX	680X0, 68302, 80X86, TMS320C30	Sun, PC (386+)	SDLC, LAPB, No Milstd 1553, TCP/IP		20 $\mu$ s, 68020	1003.4	Posix-compatible serial I/O, host I/O compatible	—/\$4,000
<b>Quantum Software Systems</b> 175 Terrence Matthews Crescent, Kanata, Ontario K2M 1W8 (613) 591-0931 <b>Circle 326</b>								
QNX 4.1	80486, 80386, 80286, 8088	PC, EISA, MCA, Ampro, Gespac, STD-Bus, VMEbus	Ethernet, Arcnet, TCP/IP, X.25, TCNS	Open Look	6 $\mu$ s, 33-MHz 80486	1003.1, 1003.2 utilities and shell, 1003.4 real-time extensions	Fault-tolerant load balancing on multiple network links	\$168/\$795
<b>Ready Systems</b> 470 Potrero Ave, Sunnyvale, CA 95062 (800) 228-1249 <b>Circle 327</b>								
VRTX Velocity 68k	680X0	Sun 3, Sparc, HP9000, DEC Ultrix	TCP/IP, NFS, RPC, XDR, TFTP	X Windows, Motif	10 $\mu$ s, 25-MHz 68020	Planned	Synchronous/asynchronous I/O, buffered, sequential	\$4,070/\$655
VRTX Velocity DOS386	80386	PC (386/486)	TCP/IP	WIX-GUI	20 $\mu$ s, 16-MHz 80386	—	Same as above	\$655/\$17,000-\$25,000 (base)
<b>RTMX-UniFLEX</b> 800 Eastowne Dr, Suite 111, Chapel Hill, NC 27514 (919) 493-1451 <b>Circle 328</b>								
UniFLEX	680X0	Self-hosted	TCP/IP, NFS	XV11R5, PEX	6 $\mu$ s, 25-MHz 68040	1003.1	Buffered, sequential, contiguous	\$500/\$5,600 (unlimited users)
RTMX	680X0, 80X86, MIPS, Sparc	Self-hosted	TCP/IP, NFS, ISO	XV11R5, PEX	10 $\mu$ s, 25-MHz 68040	1003.1, 1003.2, 1003.4	Buffered, sequential, contiguous	\$200/\$995 (users)
<b>Spectron Microsystems</b> 5266 Hollister Ave, Santa Barbara, CA 93111 (805) 967-0503 <b>Circle 329</b>								
Spox	TMS320CX0, DSP96002, MC56000, ADSP-21020, ADSP-2100	PC, Sun	—	—	1 $\mu$ s	—	ANSI C I/O interface, proprietary DSP stream, I/O interface	—/\$12,000
<b>Wind River Systems</b> 1010 Atlantic Ave, Alameda, CA 94501 (510) 748-4100 <b>Circle 330</b>								
VxWorks 5.0	680X0, 683XX, Sparc, MIPS, i960	Sparc, IBM RS/6000, DECstation, SG Iris, HP 9000	TCP/IP, NFS, RPC, XDR, rlogin, telnet, Sockets	X-11, Athena Widgets, Motif	8 $\mu$ s, 25-MHz 68020	—	Fully Posix compliant I/O	\$200/\$22,500 (10)



# MIXED-SIGNAL DESIGNERS.

As a design engineer, higher speeds and greater complexity of electronic systems are making your job more challenging. As clock speeds climb to 50MHz and beyond, analog characteristics become major considerations for digital design.

According to Technology Research Group, 40% of all ASICs will be mixed analog and digital by 1994. With this kind of demand, today's designer must be informed and prepared. Finally, there's a source for objective and up-to-date information on analog and mixed-signal design. The *Analog & Mixed Signal Design Conference*. This technical conference, sponsored by *Computer Design Magazine*, features over 50 lectures and workshops 100% dedicated to your needs. No where else will you find so much information, technology and expertise under one roof.

## HIGH QUALITY WORKSHOPS

Respected engineers will offer high-quality information that you can immediately use to complete your design projects more quickly, creatively, and elegantly. You'll learn about analog and mixed-signal simulators, different design techniques, analog implications of high-speed systems, and much more in workshops such as:

- Analog Effects in High-Speed Design
- Mixed Analog/Digital Design Modeling, Simulation, and Test
- Selecting the Optimum Analog Devices
- Digitizing Analog Functions
- Solving Convergence Problems in SPICE
- Configuring Mixed-Signal with ASICs
- And much, much more.



## PRACTICAL HANDS-ON INSTRUCTION

For years you've been subjected to press releases from vendors under the guise of objective discussions or exposed to academic papers that had little bearing on



your design problems. The Analog & Mixed-Signal Design Conference is different. You'll find in-depth, practical and real-world information from industry experts who have been there. They'll give you knowledge you can bring to the workstation tomorrow!

## WHO SHOULD ATTEND?

The Analog & Mixed-Signal Design Conference is dedicated to the unique needs of mixed-signal design. If you're a digital designer addressing the problems of high-speed designs, a digital designer involved with analog, or an engineering manager making decisions about CAE/CAD tools you must attend this conference.

## QUESTION AUTHORITY

The Analog & Mixed-Signal Design Conference Vendor Products Exhibition features booths crammed with the latest in



analog and mixed-signal design tools. As questions arise during the workshops, you can go directly to the vendor authorities on the exhibit floor for answers. They will be on hand to let you try out and compare products, give you a clear grasp of the practical tools available, and tell you where to look for new avenues of information exchange.

As an attendee at the Analog & Mixed-Signal Design Conference you'll learn how to improve your design skills, how to increase productivity, and where to turn in order to ensure design success. All in three days under one roof.

Join your colleagues this October in Burlingame. The Analog & Mixed-Signal Design Conference promises to be one of the most significant industry events of the year!



For more information call Tom Loftus at (415) 905-2354 or Fax (415) 905-2220.

CDAS3

Tell me more about the Analog & Mixed-Signal Design Conference.  
I'm interested in:  Attending  Exhibiting

NAME \_\_\_\_\_ TITLE \_\_\_\_\_

COMPANY \_\_\_\_\_

STREET \_\_\_\_\_

CITY \_\_\_\_\_ STATE \_\_\_\_\_ ZIP \_\_\_\_\_

PHONE \_\_\_\_\_ FAX \_\_\_\_\_

Mail or Fax to: **OCTOBER 28-30, 1992**  
*Analog & Mixed-Signal Design Conference*  
 Hyatt Regency  
 P.O. Box 7843, San Francisco, CA 94120-7843  
 San Francisco Airport  
 Phone (415) 905-2354 / Fax (415) 905-2220  
 Burlingame, California

SOFTWARE & DEVELOPMENT TOOLS

Typical interrupt-to-task cycle

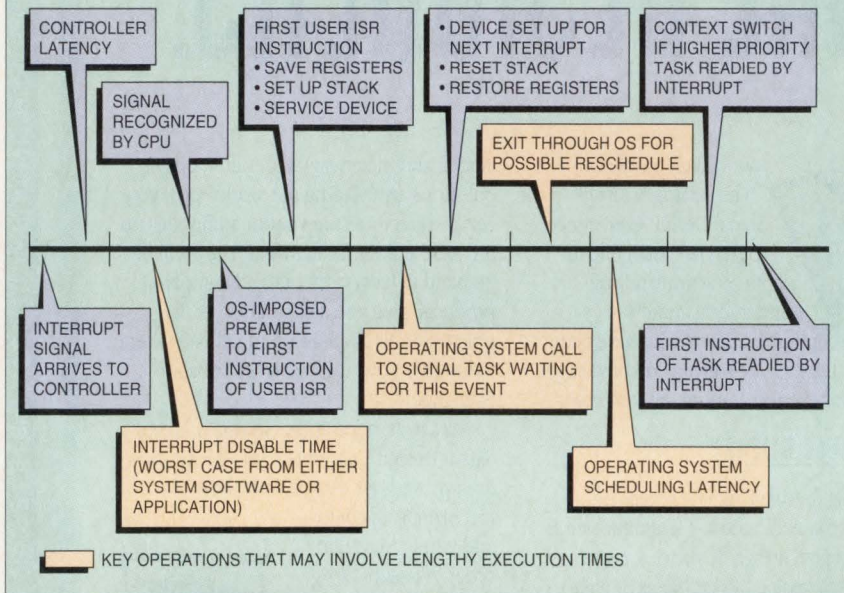

Although context switch speed is often used to judge a kernel's performance, there are more metrics to use. As the diagram shows, context switch time is only a small fraction of the total interrupt-to-task-implementation cycle. Other parts of the cycle (shaded) have much more effect on performance.

According to Inder Singh, president and CEO of Lynx Real-Time Systems (Los Gatos, CA), the Posix committee is getting close to finalizing the standard. "1003.1 is already approved. There's a very good chance that 1003.4 will be approved this year, possibly by September."

While many real-time OSs already contain some elements that require Posix compliance, Lynx has probably put more emphasis on Posix than most. In Lynx's product, Lynx/OS, there are Posix system calls in the kernel. According to Singh, this will give Lynx/OS a performance advantage over other real-

**20 MHz,  
80C186,  
\$5,000.**  
(What are you waiting for?)



20MHz performance. Guaranteed to run in target. The Checkmate-C18x™ emulator gives you a source level debugger, h/w breakpoint system, overlay and trace memory. All for less than \$5,000. If you're developing for the 80C186EA or EB, call (206) 869-7211 for a test drive.

**CheckMate  
Systems  
Corporation**

P.O. Box 3361, 7981 168th Av. N.E. Redmond, WA 98052-3361

CIRCLE NO. 64

**RTXC™ & RTX/MP™**

Written in C  
Portable by design  
Message based  
Transparent  
Distributed operation

Intel 80x86, 80x96, 8051  
Motorola 68HC11/16, 68xxx  
TI TMS320C30/C40  
Zilog Z80, Zx80  
Hitachi 6303  
Inmos T2xx, T4xx, T8xx

Dynamic priorities  
Task management  
Timer management  
Memory management  
Semaphores  
Message mailboxes  
FIFO queues  
Resource management

From  
8-bit microcontrollers  
to multiple 32-bit  
processors:  
same API with /MP!  
Four different and  
compatible versions!

Virtual Single  
Processor  
with RTX/MP!

Distributed debugger  
System generation tool  
Tracing monitor  
Standard I/O & runtime  
Signal Processing Lib

No royalties  
Source code  
3 months free  
upgrades  
and support

Free demo  
and evaluation kit  
Step-in at 900 US \$.  
New version 3.0.

Intelligent Systems International  
Lindestraat 9, B-3210 Linden, Belgium  
Tel. (+32)16.62 15 85. Fax. (+32)16.62 15 84

CIRCLE NO. 63



# If You Haven't Been To BUSCON Lately, Take A Look At What You're Missing.

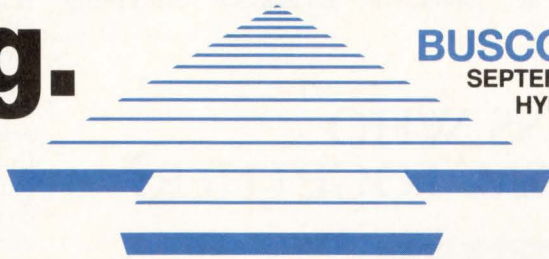

**BUSCON/92-EAST<sup>SM</sup>**

SEPTEMBER 15-17, 1992

HYNES CONVENTION CENTER  
BOSTON, MASSACHUSETTS

Over the years, BUSCON has established itself as the industry's leading forum for boards, embedded software and other elements of systems architecture.

But BUSCON is more than boards. It's a comprehensive source of information for designers in the electronic OEM. If your applications require custom design or off the shelf technology, BUSCON is the one place to satisfy all your design needs.

**Meet industry  
leading vendors  
who can help  
solve your design  
problems.**



**See the latest  
products and  
technology.  
Many  
important new  
developments  
are introduced  
at BUSCON**



**Learn from the experts who pioneered  
the technology at the industry's leading  
technical conference coordinated by  
Computer Design Magazine**



**Save time, save  
effort, save  
money- You can  
cover more  
ground at  
BUSCON in one  
day than any  
other source of  
industry  
information**

Please Send Me Attendee Information  
for BUSCON '92 East

NAME \_\_\_\_\_

TITLE \_\_\_\_\_

COMPANY \_\_\_\_\_

ADDRESS \_\_\_\_\_

CITY \_\_\_\_\_ STATE \_\_\_\_\_ ZIP \_\_\_\_\_

PHONE \_\_\_\_\_



Return to:  
CMC,  
200 Connecticut  
Avenue,  
Norwalk, CT 06856  
Phone: (800) 243-  
3238, in Connecticut  
(203) 852-0500  
Fax: (203) 857-4075

It's all happening at BUSCON '92 East,  
September 15-17, 1992 at Boston's  
Hynes Convention Center. For more  
information call (800) 243-3238,  
(203) 852-0500 or fax (203) 857-4075,  
or return this coupon.

CIRCLE NO. 61

SOFTWARE & DEVELOPMENT TOOLS

time OSs which were not designed to be Unix-like. "When other vendors provide Posix, it's probably going to just be part of their libraries, and the performance isn't going to be as fast," Singh predicts.

For its part, RTMX-UniFlex (Chapel Hill, NC) offers a real-time

version of Unix designed to let development be done directly on the target, rather than using cross-development with a host system. Derived from public releases of BSD Unix, the new system includes RTMX/RN, containing networking and real-time functions, and RTMX/XW, containing

MIT X11R5+ Motif. Key features of the system are fixed-priority real-time tasking, contiguous file support, Network File System (NFS) support, and shared memory.

**■ If you need it all**

Although Posix-compliant real-time OSs look like Unix, they're not full Unix versions. Designers that need both real-time capabilities and full Unix may want to consider Venix, a real-time embedded OS from VenturCom (Cambridge, MA). Not a Unix look-alike, Venix is actually Unix System V with real-time enhancements. The Venix kernel can boot and run without an operator, and can be embedded into ROM.

In its first use of a commercial real-time OS, Rockwell International chose Venix for its Boeing 777 systems. Venix controls several systems, including separate display/computers for the pilot, copilot and flight attendants. All of these systems support X Windows and are networked to a common database through Open Systems Interconnection over an FDDI (Fiber Distributed Data Interface) fiberoptic cable.

One trade-off with most of the highly functional, Unix-like real-time systems stems from their size. While this isn't an issue for large systems where the software is stored on disks or distributed across several boards, size can be a serious constraint in high-volume, deeply embedded applications such as fax machines and laser printers.

With this in mind, VxWorks from Wind River Systems (Alameda, CA) offers a scalable system. The full development system includes the target tools, file system and high- and low-level networking services. At the bottom are the tools and the kernel. The latter includes a small set of components surrounding the kernel that are actually used in the application, such as message queues, semaphores and schedulers. "Depending on your application, you may require a networked operating system and a file system," says Tony Barbagallo, manager for product marketing at Wind River Systems. "For data acquisition and control, for example, you may want to have the local disk run VxWorks. You could have your disk connected to one board, but get your data across the network from another VxWorks. But once you're in

## GUESS WHO BRINGS THEM TOGETHER?



You already know Globe as The Bracket Leader, offering the widest range of standard bracket designs for computers, add-on-boards, peripherals, and electronic equipment. With over 1500 standard brackets available, Globe offers you a wider choice of product and award winning quality. Now you can get that same quality, product variety and prompt service for all of your connector needs, too!

**ONLY GLOBE OFFERS YOU BRACKETS AND CONNECTORS FROM A SINGLE SOURCE.**

Whatever your connector needs, Globe has them. D-Sub Connectors, I.C. Sockets, Ribbon Cable Connectors, IDC Connectors, Video Connectors, and much more. When you consider that no one offers you as wide a choice of standard brackets and connectors as we do, it's easy to see that Globe is the only name you need for all of your bracket and connector requirements.

One name - Two product lines - One single source. **Globe.**

Call us for all of your brackets. Call us for all of your connectors. Or better yet, call for both. There's no need to do twice the work when one call will do it all. For a free copy of our bracket and connector catalogs, call us at **1-800-227-3258**, or return the coupon below today.



**Globe Manufacturing Sales, inc.**

1159 Route 22 East, Mountainside, NJ 07092 • (908) 232-7301 • Fax: (908) 232-4729

**Send me the following catalogs:**

Have a Sales Representative contact me.  Connectors  Brackets

Name \_\_\_\_\_ Title \_\_\_\_\_

Company \_\_\_\_\_

Address \_\_\_\_\_

City \_\_\_\_\_ State \_\_\_\_\_ Zip \_\_\_\_\_ Phone \_\_\_\_\_

CIRCLE NO. 62

that final application, you probably don't need your development tools. VxWorks lets you take those pieces away as needed."

Ready Systems, a company that focuses specifically on hard real-time applications and deeply embedded applications, plans to release Version 2.4 of its VRTX-Velocity environment soon. The product is currently shipping in beta form on the HP/9000 425 system, while updates for the Sun 3 and 4 workstations supporting X Windows and Motif will be available early this month.

The new release includes an enhanced run-time kernel, along with the latest releases of Microtec Research and Oasys compiler tools. Full, integrated support for the 68040 and 68332 is also provided, along with major enhancements to the networking component, file management system and multiprocessing part of VRTX.

According to Ready Systems' (Sunnyvale, CA) Jim Ready, adding support for the 68040 required careful attention because of the chip's data cache. On the 68040, the memory management unit (MMU) must be used in conjunction with the data cache, or else errors can occur. The new VRTX release supports the MMU and lets pages be set individually. "There's a problem of consistency between the cache and the main memory, and if you don't do something special, things may run for a long time, but it can eventually crash," says Ready.

#### ■ For the cost-conscious

When designing an antenna controller system for a 7,500-ton, 100-m radio telescope, David Lamb, senior software engineer at the Precision Controls Division of Radiation Systems (Richardson, TX), chose to use the QNX operating system from Quantum Software System. "The main reason we chose QNX 2.0 was because it could do everything we needed it to do at the best price," says Lamb. "And since we were using the PC bus, there were some others that were not really appropriate."

Another aspect of QNX that Lamb found impressive was its development environment. "[Using QNX] our team is averaging between 2.5 and 3 lines of code per hour, executable," says Lamb. "This includes

the initial time of deciding how to proceed all the way through test." On the down side, Lamb points out that because QNX runs on the PC, the company couldn't tie CASE tools to the same platform it's using for development. "When CASE tools don't tie directly into your develop-

ment, they aren't used well enough—CASE tools become front-end-only tools, rather than complete-lifecycle tools." This is perhaps an area where the Unix-like real-time OSs offer an advantage, since most of today's sophisticated CASE tools run under Unix. ■

**A**ffordable real-time Digital Signal Processing becomes a reality with Vigma's high-performance digital audio boards for VME and SBus. You'll find exclusive features such as programmable coding and sampling rates from high-fidelity DAT or CD performance down to telephone bandwidths (16-bit linear to 4-bit ADPCM).

Each board has a 56001 DSP for each audio channel, plus multi-ported store-and-forward RAM, on-board firmware in EPROM, and direct audio inputs and outputs. Vigma's unique DSP expansion bus provides an easy method for adding multiple channels and customized analog front ends.

For post-acquisition processing, use Vigma's **Audio Editing Toolkit** to make seamless splices and dazzling dubs — ideal for preparing interactive audio such as flight simulation, voice synthesis and communication response systems.

Vigma's board audio/DSP product line and custom capability assure you just the right match for your application. Call us today, and discover why Vigma is the leader in board-level audio.

**VIGRA**

4901 Morena Blvd., Bldg. 502, San Diego, CA 92117 (619) 483-1197 FAX:(619) 483-7531

## Next-generation Sparc—can less be more?

**H**yperSparc, the second generation of Sparc processors from Cypress Semiconductor (San Jose, CA), can be thought of as a small hop, rather than a giant leap, down the road toward VLSI integration. In effect, three new devices comprise the chip set's cast of characters. The CPU itself boasts less than 1.1 million transistors.

Does it matter? Apparently not. "Our aim is to make small chips

that handles all integer instructions, plus load and store instructions. It provides eight overlapping register windows and eight global registers. A core instruction scheduler decodes, groups, schedules, and dispatches instructions.

It can launch two instructions per clock cycle to any of four logic blocks: load/store, branch/call, integer, and floating-point units. It also identifies and controls interrupts. The

latches, an on-chip pipelined write buffer and separate input/output power supplies.

While other manufacturers such as Digital Equipment Corporation (Hudson, MA) have already moved to true 64-bit CPUs as well as 3.3-V operation, this generation of devices from Cypress didn't make it that far. The CPU is very much a traditional 32-bit device, and it works from a traditional 5-V supply to boot.

This isn't to say that Cypress ignores the advantages of 64 bits. The intramodule bus connecting the processor, CMTU and CDU, for example, does operate from a 3.3-V level to minimize noise at high clock rates. And the chips do communicate over this bus, which sports a 64-bit datapath as well as 32-bit addressing. Nevertheless, the instructions and addresses are all 32 bits.

To make life easier for designers, Cypress will make the devices available in modules, so you won't have to trouble yourself with the nuances of 40-MHz design rules. The first HyperSparc modules in the Sparccore family are the uniprocessor CYM6221K M bus module with 128 kbytes of cache, the dual-processor CYM6222K M bus module with 128 kbytes of cache per processor, and the dual-processor CYM6226K M bus module with 256 kbytes of cache per processor.

All three Sparccore modules operate with 55.5-MHz internal clocks and will be in full production in the fourth quarter. Samples of modules with clock rates up to 80 MHz will be available later. For the CYM6221K single-processor module, the price is \$3500 in quantities of 100.

—Dave Wilson

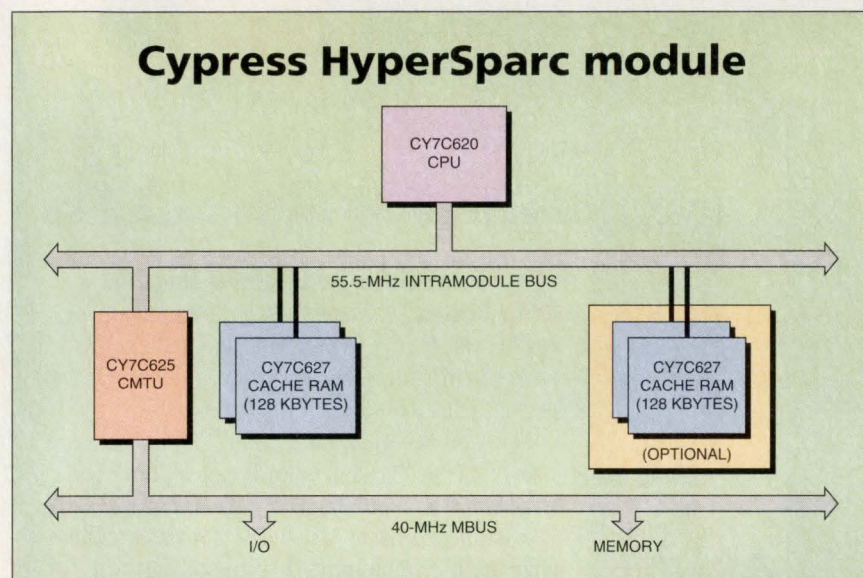

Here comes 64 bits! The Cypress CY7C620 processor communicates with the CY7C627 cache RAMs and CY7C625 CMTU over a 3.3-V, 55.5-MHz intramodule bus with a data width of 64 bits.

perform like big chips," reports Roger Ross, president and CEO of Ross Technology, the Cypress subsidiary responsible for HyperSparc.

The CY7C620 is an integrated CPU with an on-chip integer and floating-point unit. Second in command is the triple-duty CY7C625 cache controller/MMU/tag unit (CMTU); bringing up the rear is the CY7C627 cache data unit (CDU) with on-chip write buffers. Together, the devices form the heart of several different modules that Cypress offers at a variety of different price/performance points.

### ■ CPU is superscalar pipeline

The CY7C620 processor is a multiprocessing, superscalar, six-stage pipeline device with a CPU datapath

core instruction fetch unit selects the next instruction, maintains the program counter and executes branches and calls. Hardware interlocks handle conflicts that result from resource dependencies, relieving compilers of the burden.

The CY7C625, in addition to boasting all the same features as Cypress' earlier CY7C605 multiprocessing cache controller/MMU, adds a clock synchronizer that makes the module's dual clock scheme run efficiently. Special multiprocessing features include a tag memory that's physically tagged and virtually indexed for snooping, write-through or copy-back protocols, and direct data intervention with memory reflection.

Each CY7C627 synchronous CDU incorporates on-chip address data

### HyperSparc at a glance

- High-speed intramodule bus
- CPU with on-chip IU/FPU
- 62 specmarks
- Preconfigured modules

**Cypress Semiconductor**  
3901 N First St  
San Jose, CA 95134  
(408) 943-2600

Circle 354

# NOW, IN THE TIME IT TAKES TO READ THIS AD, YOU CAN RECEIVE THE DATA SHEETS YOU NEED



**INFORMATION YOU NEED ABOUT AN ADVERTISED PRODUCT  
CAN BE YOURS IN AN INSTANT BY FAX,  
ONLY FROM COMPUTER DESIGN!**

## LET "IDA" DO IT!

Just call **IDA**  
Computer Design's  
"INSTANT DATA ACCESS."

Get specs, pricing information,  
or the location of a local sales  
engineer or rep...by simply  
touching a few buttons.

If an ad in this issue of  
*Computer Design* includes an

## **IDA** INSTANT DATA ACCESS

number, you don't have to wait to  
get the details you need to make  
critical design or purchasing  
decisions.

## IT COULDN'T BE EASIER!

The next time you need product  
information in a hurry, just call

**IDA** (617) 494-8338

from a touch tone phone or a fax  
phone and follow the voice  
prompts.



## IDA

*This month, these  
participating advertisers have  
made information instantly  
available to you*

advertiser	document no.
ATEMEL	1050
Computer Design	1047
Force	1049
Hitachi	1034
Ironics	1046
KADAK	1036
SBE	1040

*Still available from last  
month (through the end of  
next month):*

advertiser	document no.
ATEMEL	1045
CMC	1025
Force	1049
Hitachi	1034
KADAK	1036
Macrolink	1037
Mercury	1020
Synergy	1042
Computer Design	1047

## IT COULDN'T BE EASIER!

Using a fax phone...

1. Make note of the **IDA** document number you're interested in.
2. Pick up your fax phone and dial **(617) 494-8338**.
3. Follow the voice prompts.
4. Replace the handset in the cradle and the product data you requested will be faxed back to you without a break in your connection!

Using a touch tone phone...

1. Make note of the **IDA** document number you're interested in.
2. Pick up your phone and dial **(617) 494-8338**.
3. Follow the voice prompts.
4. Hang up the phone and the information you requested will be faxed back to you, right to the fax number you specify!

**ONLY COMPUTER DESIGN  
GIVES YOU "IDA"—INSTANT DATA ACCESS —  
SO YOU CAN GET THE DETAILS YOU NEED  
INSTANTLY — BY FAX!**

Delivering Today's Electronics OEM

COMPUTER DESIGN • ONE TECHNOLOGY PARK DRIVE, WESTFORD, MA, 01886 • 508-692-0700 • FAX 508-692-7780

**IDA** INSTANT DATA ACCESS (IDA) DIAL (617) 494-8338 DOCUMENT NO. 1047

CIRCLE NO. 65

**COMPUTER  
DESIGN** Technology  
and Design  
Directions

## Simpler is faster for new Windows chip

A new accelerator chip enhances performance of the Microsoft Windows graphical user interface by leaving most of the work to the CPU. Called the 64200 "Wingine" by Chips and Technologies (San Jose, CA), the chip eliminates bottlenecks in graphics performance caused by single-port DRAMs and the PC's ISA system bus. It also avoids complex electrical interfacing and timing problems associated

bottlenecks were the load on the CPU caused by doing low-level graphics computation and the bandwidth of the system bus, which had to transport all the pixel data.

In PC systems, the system bus—typically the AT or ISA bus, with its 8-MHz bandwidth—remains an obstacle to higher performance. Another is the path that graphics data has to take—commands go from the CPU via the system logic

operations common to Windows, while taking advantage of the speed of the CPU's memory bus and of dual-port VRAMs. As a result, graphics throughput is directly scalable as a function of processor speed.

### Compatibility preserved

The 64200 Wingine maintains VGA compatibility, so that a system in which it's used can run DOS-based, non-Windows VGA applications unaltered. The Wingine contains Super VGA logic, and, when it first powers up, it's in SVGA mode. Chips and Technologies has developed a switch that works in conjunction with its PEAK/DM family of 386 and 486 system logic products to detect whether or not Windows is running. When this so-called "Winglue" 64201 chip detects that the system is in DOS mode, it switches data going over the system bus to the Wingine running in SVGA mode. When Windows is running, the Wingine takes over.

Production quantities of both the 64200 and the 64201 are scheduled to be available in June. In large volumes the price of the 64200 will be \$18.00, and the 64201 will be \$7.00.

—Tom Williams

### Wingine memory bus architecture

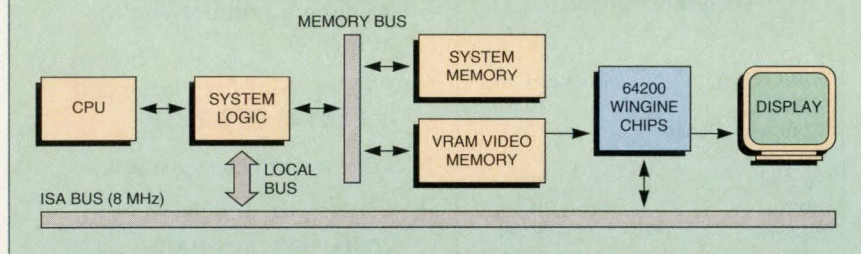

The 64200 Wingine's memory bus architecture lets the CPU address VRAM video memory as system memory. The CPU is able to do all the graphic computational work and write to VRAM. The Wingine processes the pixel data out of VRAM to the display, all without involving either the CPU's local bus or the system bus.

with connecting graphics accelerators to the CPU's local bus. The result is that any upgrade in CPU performance, whether it's an improvement in clock speed or an upgrade to a faster class of CPU, has an immediate effect on Windows performance.

The Wingine lets the CPU access display memory, which uses a dual-port video RAM as part of its system memory. The CPU simply writes the graphical data into video memory via the video RAM's parallel port. The Wingine shifts the pixel data out via the VRAM's serial port and sends it directly to the display. Graphic data flows in a single direction and avoids both the system bus and the local bus.

### Going against convention

For a number of years, the conventional wisdom in graphics acceleration has been to unburden the CPU from the details of graphics processing by using a chip that could process high-level commands sent by the host processor into pixels to be displayed on the screen. The two main

over the ISA bus to the VGA controller. The VGA controller processes the commands and puts pixel data into DRAM video memory. Then it removes pixel data from DRAM and sends it to the display.

One common method of increasing VGA performance for Windows has been to add a bitblt (bit boundary block transfer) engine to the VGA controller. But this still means reading data out of DRAM memory and writing it back in at a new location. Another approach has been to interface the VGA controller directly to the CPU's local bus. This avoids the system bus bottleneck, but it entails complex electrical and timing issues, making system design more difficult, and there are as yet no standards for a local bus interface.

It's the blinding speed of today's CPUs that's allowed rethinking of the graphics coprocessor approach—at least for Windows in PCs. It appears now that it's faster to let the CPU handle the 2-D drawing, bitblt, rectangle fill, and other

### 64200 Wingine at a glance

- 32-bit data path directly from host CPU to VRAM display memory
- In Windows mode, accesses video memory as system memory
- Data transfer rates of 20-40 Mbits/s
- Uses standard 256k x 4 VRAMs, up to 2 Mbytes
- Supports resolutions of 640 x 480, 800 x 600, 1024 x 768, and 1280 x 1024
- Refresh rates up to 72 Hz

### Chips and Technologies

3050 Zanker Rd  
San Jose, CA 95134  
(408) 434-0600

Circle 351

# NEW & NOW



**ICEBOX™ VMEbus  
System Enclosure**

## The Case For The Best Case.

Would you believe close to half the spurious board level problems in your system are enclosure-related? Odds are, they are. The new Ironics ICEBOX roots out tricky system problems — *before they start.*

ICEBOX answers cooling demands that leave muffin fans gasping for air, because our 550 CFM Blower/Diffuser/Plenum (patents pending) ensure vigorous, even cooling no matter how dense your slot loading — *with no "dead" spots.*

ICEBOX's 16 gauge steel cabinet, swing-aside power supply (patents pending), and uncluttered interior layout give you a tough, accessible case with plenty of room to mount *all the I/O your system requires.*

ICEBOX's premium electronics produce vast power reserves, while limiting electrical noise. Each component is selected to reduce headaches and improve reliability, because we know *you'd rather tune your application — not the box you've put it in.*

*Call our VME Product Hotline today — 800-334-4812.*



IRONICS Incorporated  
798 Cascadilla Street  
Ithaca, New York 14850 USA

607.277.4060  
Fax 607.272.5787  
Telex 705742



INSTANT DATA ACCESS (IDA) DIAL (617) 494-8338 DOCUMENT NO. 1046

## Unix-based CAE suite adapts to multitool environments

**V**iewlogic Systems (Marlborough, MA) has revamped its suite of EDA tools by optimizing them for Unix-based workstations, adding new simulation capabilities and offering a graphical VHDL entry format.

The software, dubbed Powerview, is a framework-based suite that's consistent with the CAD Framework Initiative's (CFI) 1.0 standards, as well as OpenLook/Motif and EDIF 2.0.

comes an icon. This lets you assimilate tools into the framework without modifying any source code, either the tool's or Powerview's—for example, each tool definition carries its own file. The framework interprets and invokes the file with the tool's own command line syntax.

### Viewsript customizes GUIs

Viewlogic has also developed an extension language called Viewsript

designs whenever you make changes. With save-and-restore, you can pause during the design of a large ASIC and save the state of the simulator at any point in time and restart later exactly from that point.

To help overcome the complexity and tedium associated with writing high-level circuit specifications, Viewlogic offers two aids—Envision VHDL and a graphical source-level VHDL debugger. Envision VHDL, a front-end tool that Viewlogic has licensed from i-Logix (Burlington, MA), lets you represent designs graphically via state-transition and data-flow diagrams. It then automatically produces VHDL code which is compatible with Viewlogic's simulator and the synthesis tools from Synopsys (Mountain View, CA). With the VHDL source-level debugger, you can interactively step through VHDL source code and correct it as it executes.

Powerview also features ViewPLD, a synthesis capability developed jointly by Viewlogic and Data I/O (Redmond, WA). With ViewPLD, you can map industry-standard formats—Abel, CUPL, JEDEC, and Palasm—into FPGAs.

Powerview is available now on Sun workstations. The basic tool suite is priced at \$17,500. —Mike Donlin

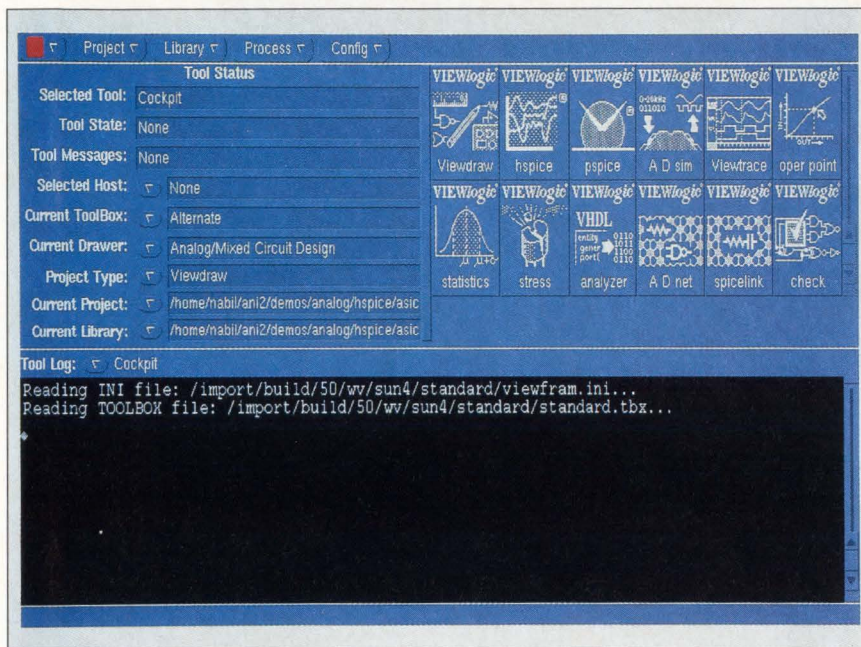

Viewlogic's Powerview cockpit provides a customizable environment through which all tools can be launched. Here, the palette of available tools is displayed in the top window. The bottom window displays a log which tracks the tools currently in use.

The new software is also compatible with Viewlogic's DOS-based toolset, Workview, which means that data can be shared between the two environments over a network of personal computers and workstations.

By basing Powerview on CFI's standard, Viewlogic has implemented methods for tool encapsulation, intertool communication and design representation. To Powerview, a tool is simply an executable program, regardless of its function. An encapsulated tool is surrounded by a shell that maps the syntax required to invoke the tool into graphics and icons—the invocation syntax be-

which lets you adapt Powerview to individual environments and interactively access the application programming interface of framework tools. With this capability, you can customize the graphical user interface (GUI) as desired and incorporate in-house and third-party tools. All tools are managed through a front-end "cockpit" which lets you manage portions of designs and the tools associated with them.

The new simulator in Powerview, Viewsim/XL, provides incremental netlisting and save-and-restore features. With incremental netlisting, you don't have to recompile entire

### Powerview at a glance

- Conforms to CFI 1.0, OpenLook/Motif and EDIF 2.0
- Adapts to in-house and third-party tools by encapsulating them as executable programs
- Features the Viewsim/XL simulator which provides incremental netlisting and save-and-restore capabilities
- Envision VHDL lets you represent designs graphically and generates VHDL code automatically
- ViewPLD software provides migration path for programmable logic into other technologies such as ASICs and gate arrays

### Viewlogic Systems

293 Boston Post Rd W  
Marlborough, MA 01752-4615  
(508) 480-0881

Circle 360



## Software generates analog behavioral models

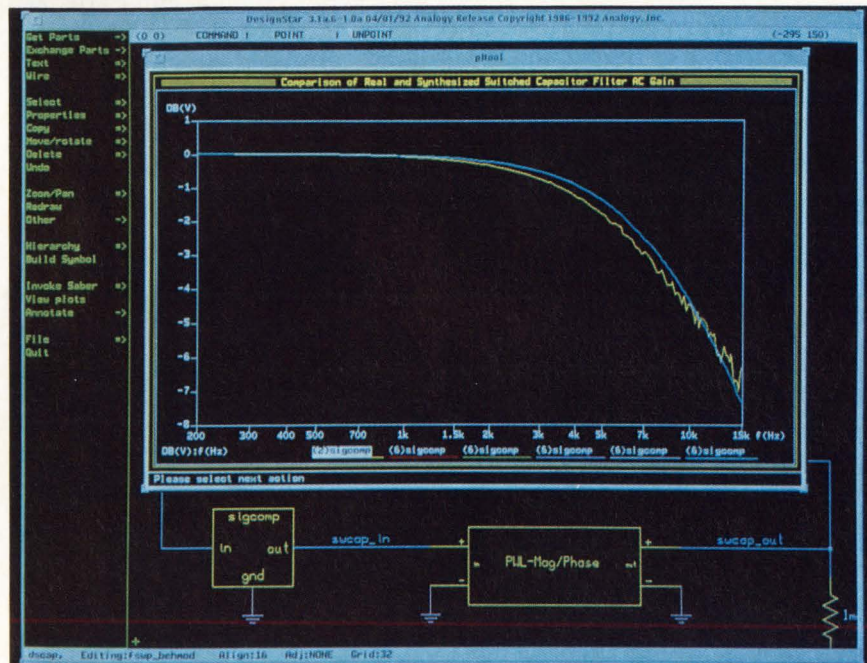

In this comparison of the frequency response of a switched capacitor filter, the waveform for Analog's synthesized behavioral model (blue trace) closely correlates with the actual device output (yellow trace) over the entire operating frequency.

Critics of Analog's (Beaverton, OR) Saber simulator and Mast analog hardware description language have cited difficulty of use as a stumbling block to their widespread acceptance. With the announcement of Analog Model Synthesis for Saber, Analog has taken a step toward silencing these complaints. The tool uses graphical data from previous simulations or from laboratory measurements and automatically transforms them into behavioral models, a capability that Analog says eliminates the need for equations or modeling code.

### Automation speeds things up

To create a behavioral model, you specify the waveform that you want to use for model generation captured from previous simulation or from lab instruments. Then, by activating the Saber simulator, the model is automatically loaded.

Key data is automatically extracted from the waveform and used to create the behavioral model. For example, in a frequency-domain

simulation, the appropriate poles and zeroes are extracted and placed in the proper frequency positions. Mast code is generated from this data and the model is created.

According to Analog, model synthesis also reduces simulation time because behavioral models run faster than equivalent circuit-level models. Analog uses a behavioral model for a switched capacitor filter (SCF) to back up this claim. Because of the high-frequency switching inherent in this type of filter, primitive-level simulations can take hours. A behavioral model, on the other hand, will simulate in seconds with accurate results. To synthesize the behavioral model, the frequency range of a primitive-level simulation of the SCF is swept using a pre-existing instrument template created in Mast. The resulting frequency response is then loaded directly into the synthesized model for specific applications, an approach that ensures accuracy on a behavioral level.

Data from lab instruments can also generate waveform input. For

ICs that will be inserted into a printed circuit board, for example, you can make measurements of the target circuit board and input this data as stimulus during the simulation of the IC. The data can also be fed back from simulation to the measurement equipment, which lets you test the board with the simulated IC data.

In addition to model synthesis, Analog has also created a technique for analog stimulus generation. Like analog model synthesis, stimulus generation has its origins in waveforms which can be transformed into stimuli for circuit simulation in either the time or frequency domain. For example, if you want to simulate a sensor and a signal-conditioning circuit followed by a Z-domain filter, the resulting waveform can be used as the input stimulus for the filter. Alternatives to stimulus generation, such as simulating the entire circuit each time an individual stage needs to be analyzed or manually entering stimulus data for each stage, can increase overall simulation time.

The Analog Model Synthesis software will be available in July as part of Analog's DesignStar environment. Prices begin at \$2,000.

—Mike Donlin

### Analog Model Synthesis at a glance

- Uses graphical data from previous simulations or from laboratory measurements to create behavioral models
- Eliminates the need to use equations or modeling code to create behavioral models
- Creates analog stimulus data in either the time or frequency domain
- Available in July with prices starting at \$2,000

**Analog**  
9205 SW Gemini Dr  
Beaverton, OR 97005  
(503) 626-9700

Circle 361

## Mini motherboard helps PC/104 expansion

**D**ubbed Little Board/386SX by its developers at Ampro Computers (Sunnyvale, CA), a compact, low-power 80386SX-based PC/AT puts all the power of a full-sized industrial PC on a 5.75 x 8 in. board. In addition to on-board features, the board can accept standard PC/104 modules for a variety of add-on options, such as EGA or VGA graphics, specialized communications and other functions. Scores of such modules are offered for the platform by Ampro and more than 20 other companies that have adopted the PC/104 proposed standard.

In addition to a 25-MHz 386 processor, the Little Board accepts up to 16 Mbytes of on-board DRAM, and has dual serial and parallel controllers, a floppy drive controller, an IDE hard disk drive interface, and a SCSI port.

### Enhanced BIOS

Consistent with its targeted applications in embedded systems, Ampro's product includes a set of enhanced BIOS services. These include a bootable "solid-state disk" to make the board particularly attractive for embedded applications where rotating media may cause mechanical or reliability problems. In addition, the BIOS is tailored to support a wide variety of SCSI drives, and has a unique SCSI/BIOS function to simplify development of custom SCSI applications. The BIOS also supports the board's watchdog timer, allowing for initialization and providing BIOS functions for application software.

The specially modified BIOS also supports other functions critical to

embedded applications. These include the ability to download executable code from a remote device prior to system boot, an EEPROM access function that allows high-level access to the nonvolatile OEM data area in the configuration mem-

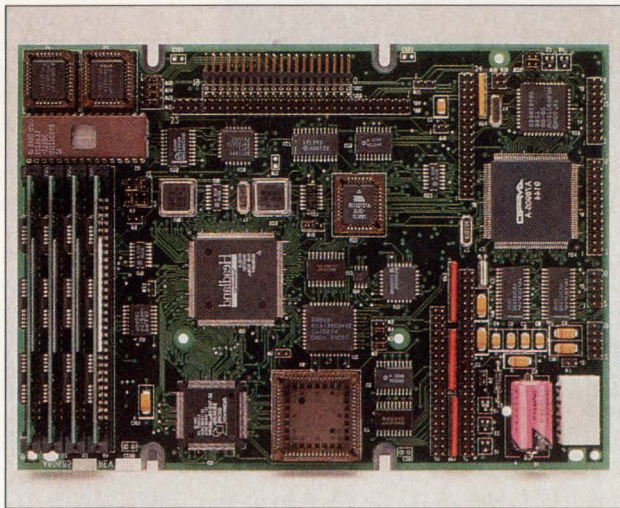

*Ampro Computer's Little Board/386SX is a high-performance, low-power (below 5 W) industrialized 80386SX motherboard in a compact form factor (5.75 in. x 8 in.). Consistent with its small form factor, expansion capabilities, when required, use PC/104 accessory modules.*

ory, and OEM hooks which let the system execute custom code prior to system boot, allowing for system customization without modification.

"What we offer," says David Feldman, Ampro president, "is a complete platform for a high-performance AT-based computer on a compact board. With the Little Board, as well as our other compact PC-compatible embeddable computers, [it] isn't just an alternative to 'build your own.' We're offering that all-important time-to-market advantage inherent in complete, tested and reliable subsystems. And because it's based on the industry-standard DOS operating system, software development is simplified—and often available commercially for many applications."

### Designed for embedding

The Little Board, as Feldman explains, is designed specifically to be

embedded into another system. That's why, for example, a graphics interface isn't included. Unlike other features, such as the serial and parallel ports, graphics interfaces can be more costly and are often specialized for specific display types such as LCDs or other flat-panel industrial displays.

The Little Board uses CMOS circuitry that makes it extremely stingy in the power consumption department. This lets the board be used in small and confined areas, because it dissipates only 5-W—less than a single Christmas tree light-bulb—and doesn't require additional forced-air cooling.

Yet, even with all these features, Little Board/386SX sells for only \$720 each in quantities of 100 and is available now.

With a broad customer base, Ampro continues to support its products despite rapid changes and evolution in the PC market. This support includes maintaining end-of-life inventories of critical PC chip sets, providing full documentation for any product or subsystem upgrades and maintaining compatibility with previous generations of products.

—Warren Andrews

### Little Board/386SX at a glance

- PC/AT-compatible single-board system
- AT motherboard features
- 25-MHz 80386 CPU
- Up to 16 Mbytes of DRAM
- Dual serial and parallel controllers
- Floppy drive and IDE hard disk controllers
- SCSI interface
- Bootable solid-state disk
- Watchdog timer
- PC/104 module expandable
- 5-W operation

**Ampro Computer**  
990 Almanor Ave  
Sunnyvale, CA 94086  
(408) 522-2100

Circle 358

COMPUTER DESIGN AND PENNWELL WELCOME A NEW PARTNER

# Military & Aerospace E L E C T R O N I C S

A PennWell Publication



Now, *Computer Design Magazine* and PennWell Publishing can help you meet your military/ aerospace requirements with one unique, dedicated, concentrated publication — *Military & Aerospace Electronics*.

*Military & Aerospace Electronics* is a colorful, tabloid size, monthly magazine serving the unique informational requirements of today's military/aerospace engineers and engineering managers.

In only two years, it has grown to a position of high visibility, strong identity and important readership with 46,000 BPA qualified subscribers at DoD/NASA/prime

contractors, manufacturers of systems/subsystems and other OEMs — 96% of whom have Design/Buy/Specify authority.

Now, *Military & Aerospace Electronics* and *Computer Design* are partners within PennWell Publishing's Advanced Technology Group providing a strong editorial and circulation platform.

It takes this kind of organization to understand, cover and service the growing technology opportunities within the turbulent Military/Aerospace marketplace.

Come join us, the ever stronger *Military & Aerospace Electronics* in partnership with *Computer Design Magazine*.

**PENNWELL PUBLISHING COMPANY ADVANCED TECHNOLOGY GROUP**  
ONE TECHNOLOGY PARK DRIVE, WESTFORD, MA 01886 508 692 0700 FAX 508 692 7780

## Military & Aerospace E L E C T R O N I C S

COLOR PUBLISHING • COMPUTER ARTIST • COMPUTER DESIGN • COMPUTER GRAPHICS WORLD • LASER FOCUS WORLD  
• LIGHTWAVE • MICROLITHOGRAPHY WORLD • NETWORKING MANAGEMENT • SOLID STATE TECHNOLOGY • TYPEWORLD

CIRCLE NO. 67

## Data acquisition marries DSP on single board

**A** new series of data acquisition boards now offers combined test, measurement and processing in a PC/AT format. The boards include precision analog and digital I/O subsystems combined with a Texas Instruments 320C40 digital signal processing (DSP) chip. The family of three boards, each providing different sampling rates and resolutions, comes from Data Translation (Marlborough, MA).

Designed as a total test solution, the boards include analog waveform digitizer and synthesizer subsystems for analog signal input and output, dynamic digital input and output subsystems and host communications over the ISA bus.

"It takes all the I/O capabilities of the 320C40 to handle the communications," according to Mitch Reifel, marketing manager for DSP products at Texas Instruments (Houston, TX). "Every C40 data I/O facility, all six communications ports plus the six-channel DMA engine are needed to service the board's high-throughput analog and digital I/O subsystems, while leaving the processing power to squeeze an entire test and measurement system onto a single PC/AT board."

### No host interaction

Clever application of the 320C40 lets it manage all data capture, control, transfer, and calculation without any host interaction. Communication with the host operating system uses the 320C40's high-level message passing. Data can be preprocessed in the 320C40, or sent directly to the host using the DMA. All communication between the board and the host is performed transparently by device drivers.

Data movement is performed as I/O through the 320C40 communication ports and under control of its multichannel DMA. Data movement is concurrent with data processing. Contention for memory access is minimized, letting the 320C40 CPU spend a larger percentage of its time on processing—and less on overhead.

The six DMA channels access two separate memory spaces via two independent buses. Each data interface subsystem uses a 320C40

communication port and DMA channel to send data to and from memory. This provides high-speed data transfer and minimizes bus contention.

The four separate subsystems—waveform digitizer, waveform synthesizer and dynamic digital input and output—provide the capability to address complex test and measurement needs. The waveform digitizer lets an analog waveform be captured and stored anywhere in the 320C40 memory space. Each 12- or 16-bit sample, depending on the board model, can be automatically sign-extended to 32 bits for direct processing by the 320C40 as two's complement integer data. Alternately, data packing is supported for memory conservation in non-real-time applications.

The Data Translation DT3801 series of boards also offers a flexible triggering scheme. The subsystems can use any of four independent software and two external polarity-selectable digital triggers. Triggers may start transfer with any combination of subsystems simultaneously. For samples to be stored both before and after an event, a separate digital trigger is used for pretriggering on an analog input. In addition, any of the subsystems can be operated by a delayed trigger, the delay determined by a user-programmable sample count.

### The three-board family

The current family of DT3801 boards comprises three models, the DT3801G, DT3808 and DT3809, each providing different choices of analog input for different applications. The DT3801G provides eight differential channels with 12-bit resolution and sampling rates up to 250,000 samples/s. Software-selectable anti-aliasing filters are available to reduce high-frequency noise. Inputs can range from  $\pm 10$  V, with selectable gains of 2, 4 and 8 available to increase the effective resolution.

The DT3808 includes an internal simultaneous sample-and-hold for channel-to-channel phase alignment. Like the 3801G, it also accepts signals from  $\pm 10$  V from eight differential channels, but includes a 16-bit, high-resolution converter.

This limits the aggregate acquisition rates to 160,000 samples/s.

The 3809 is aimed at applications calling for high-speed sampling. It can capture a single channel at up to 1 Msamples/s. It can be configured to read either eight differential or 16 single-ended inputs at 12-bit resolution.

Shipments of the new boards are expected about mid-August 1992. Quantity-one prices for the family vary, with the DT3801G being the most expensive at \$7,595, and the DT3808 the least expensive at \$7,195. The high-speed DT3809 is in the middle at \$7,495. Data Translation also offers a variety of development tools, including a complete developer's kit in which the company repackages the Spox DSP operating system and TI's tools.

—Warren Andrews

### DT3801 series at a glance

- Integrated test, measurement and processing boards
- Full PC/AT (ISA) interface
- Independent A-D I/O subsystems with internal or external clocking
- TI 320C40 DSP with Spectron Spox DSP OS
- Uses 320C40 communication ports and intelligent DMA
- 4 Mbytes of DRAM (1 Mword  $\times$  32 bits)
- 512 kbytes of SRAM
- 8 kbytes of nonvolatile RAM
- Software development support
- High performance A-D subsystems, up to 1 million 12-bit samples/s
- Two-channel 16-bit waveform synthesizer
- Real-time clock, two 16-bit counters, four-bit static DIO channels

### Data Translation

100 Locke Dr  
Marlborough, MA 01752  
(508) 481-3700

Circle 359

## Oki enhances sea-of-gates performance

Two weeks ago, Oki Semiconductor (Sunnyvale, CA) announced the 0.8- $\mu$ m CMOS three-layer metal MSM30S0000 sea-of-gates arrays, with up to 225,000 gates, of which 135,000 are usable. Based on Oki's first-generation 16-Mbit DRAM technology, the gate arrays are 30 percent faster with 75 percent more usable gates per die size than the company's earlier 0.8-mm products.

Also just announced are Oki's 0.8- $\mu$ m CMOS two-layer-metal MSM91S000 customer-structured arrays, with usable gate counts of more than 150,000 two-input equivalent gates. Based on Oki's more mature 4-Mbit DRAM technology, these products are logically compatible with the new MSM30S0000 gate arrays. MSM91S000 users can merge sea-of-gates "soft" macrofunctions with fully diffused memory and "hard" macrocells on any of Oki's 35 predesigned masterslices, with up to 225,000 total gates. Oki claims that users of customer-structured arrays will improve prototype turnaround time over totally cell-based manufacturing techniques.

Though the MSM91S000 customer-structured arrays will operate from 2.7 to 5.5 V—at oscillator speeds of up to 50 MHz at 3 V—the MSM30S0000 gate arrays operate at 5 V (with clock speeds higher than 50 MHz), with a 3-V version planned for release in July. Marketing manager Cliff Vaughan explains, "Since the MSM30S0000s are fabricated in a new high-speed process, we're having to characterize the 800-cell library at 3 V. We have to be satisfied with the accuracy."

### High-performance options

Both the sea-of-gates and structured array products have up to 840 configurable I/O cells. Ensuring high performance in both technologies, according to Oki, are timing-driven layout and clock tree macrocells. "With timing-driven layout," says Vaughan, "users can trust that their silicon will match the prelayout simulation." Oki's clock tree driver macrocells guarantee less than 1-ns clock skew at a fanout of 2200 at 70

MHz. To optimize clock tree implementation, Oki's layout software uses a dynamic-driver-placement and a subtrunk-allocation procedure. By offering both gate-array and structured-array users a choice of designing in high-speed macrocells for critical paths or high-density macrocells for noncritical paths, Oki provides the opportunity to

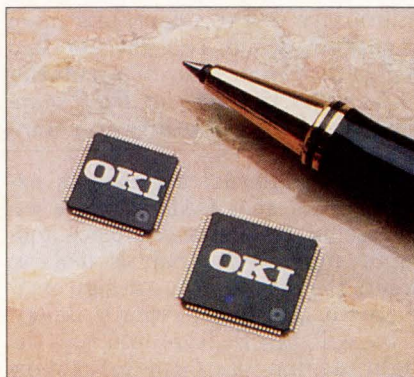

*Tiny surface-mount packages, such as the 80- and 100-pin TQFPs shown here, can be very cost-effective for 3-V ASICs like Oki's MSM91S000 customer-structured arrays. The 100-pin TQFP can handle about 0.6 W, making it suitable for about 25,000 gates at 20 MHz, or 20,000 gates at 25 MHz. A 128-pin TQFP, capable of handling about 0.75 W, will be available before year's end.*

trade speed for density and thus reduce total chip power and cell area.

The MSM30S0000 gate arrays, available in seven sizes starting at 11,000 gates, offer a standard product library of 82CXXs, UARTs and multiport memories. Other features include typical gate delays under 250 ps, with I/Os and registers usable to over 150 MHz.

The MSM91S000 customer-structured arrays offer a higher level of integration than the gate arrays and faster design capture and simulation than cell-based products. For embedded SRAM, you can use Oki's predefined SRAMs, with 6- to 12-ns access times; or you can compile up to 64 kbits of SRAM optimized for speed, with access times ranging from 6 to 15 ns, or up to 256 kbits of SRAM optimized for density, with access times from 12 to 20 ns. ROMs optimized for speed are available

with densities greater than 256 kbits, and ROMs optimized for density to over 10 bits/gate area. Oki's sea-of-gates macrocell logic functions are also available to MSM91S000 users.

Both of the new ASIC technologies feature automatic test vector generation using scan macros, with JTAG boundary scan in development. Circuits designed with MSM91S000 customer-structured arrays are available in quad flatpacks of up to 304 pins, with power dissipation capabilities greater than 3 W. Both gate arrays and structured arrays are available in thin quad flatpacks (TQFPs). Oki supports ASIC design software from Cadence, Dazix, Ikos, Mentor Graphics, Synopsys, and Viewlogic.

NREs (nonrecurring engineering expenses) for the MSM30S0000 start at \$29,300, with price/gate at 0.066 cents for quantities of 50,000 pieces a year. NREs for MSM91S000 customer-structured arrays start at \$53,600, with price/gate at 0.07 cents for quantities of 50,000 pieces a year.

—Barbara Tuck

### 0.8- $\mu$ m ASICs at a glance

- Three-layer-metal sea-of-gates arrays at 5 V
- Two-layer-metal customer-structured arrays, 2.7 to 5.5 V
- Up to 225,000 total gates
- Up to 840 configurable I/O cells
- Clock tree macrocells with < 1-ns clock skew
- Timing-driven layout software
- Automatic test vector generation using scan macros

#### Oki Semiconductor

785 North Mary Ave  
Sunnyvale, CA 94086-2909  
(408) 720-1900

Circle 357

## High functionality per cell in AT&T FPGAs

**A**T&T Microelectronics (Allentown, PA) has announced the first two devices in its new FPGA family which will ultimately have 3,000 to 20,000 usable gates. Initial family members are the 5,000-gate ATT1C05 and the 11,000-gate ATT1C11, both fabricated in 0.8- $\mu$ m two-layer-metal CMOS. AT&T has fine-tuned its FPGA tool-set to the Optimized Reconfigurable Cell Array (ORCA) architecture of the new FPGAs.

The company based its ORCA FPGA line on what it refers to as a homogeneous, rectangular and symmetrical architecture. ORCA devices comprise arrays of programmable logic cells (PLCs), with each PLC containing a programmable function unit with four latches and a 64-bit configurable lookup table (four 16-bit SRAMs plus a group of seven multiplexers and a two-input NAND gate), along with associated routing. The 64-bit configurable lookup table in the ORCA FPGAs is the largest currently available, according to AT&T, and lets you combine larger logic into a single PLC, permitting the most critical paths to be compacted into very few PLCs.

### On the move

Though initial ORCA devices are being fabricated in 0.8- $\mu$ m two-layer-metal CMOS, AT&T plans to move to 0.5- $\mu$ m three-layer-metal technology. User-defined I/Os in the new FPGA family will range from 120 on a 10  $\times$  10 PLC array in the 3,000-gate device, to 288 I/Os on the 20,000-gate device on a 24  $\times$  24 array. AT&T claims that system clock rates for ORCA devices go as high as 80 MHz.

Built into the AT&T FPGAs is the capability to perform nibble-wide datapath operations (addition, subtraction, shift-register, and counter) on two bused signals, whether four, eight or 16 bits wide. Also available in the ORCA devices are buffers for driving heavily loaded nodes that are speed critical.

AT&T says its software tools, developed hand-in-hand with the silicon, unlock a number of architectural features to relieve you of the burden of having to know architect-

tural details. "Today's first-time FPGA design success rate is terrible compared to that of ASICs," says Robert L. Bailey, AT&T ASIC product line director. "That's due largely to the relative inefficiencies of available CAD tools."

AT&T tools supporting the ORCA FPGA devices include a pre-layout static timing analyzer, post-layout hazard analysis tool, automatic timing-driven technology mapper, and place-and-route tools, as well as an interactive design editor, bitstream generator, design rule checker, and SoftPath design migration translators and partitioners for direct mapping to and from gate arrays or standard cells.

"AT&T Microelectronics is exploiting its vast CAD software expertise in timing-driven place-and-route and circuit analysis tools to create the most efficient design environment possible," reports Bailey. "This will provide logic designers the right design platform to achieve first-pass success on the ORCA high-density, high-speed, high-I/O reconfigurable FPGAs."

### Timing input

Input to the pre-layout static timing analyzer includes such timing specifications as clock periods and I/O timing requirements. With that data, the timing analyzer generates a set of timing requirements to be passed on to the technology mapper and place-and-route tools. Because the ORCA architecture features passive, active and long lines to optimize routing, the software can choose the fastest connection for critical paths. The new tools can perform incremental logic changes, layout changes during packing, placement and routing, as well as post-layout edits where only the sections of the FPGA design being changed are affected. Post-layout timing analysis tools backannotate timing data to simulation tools and also to AT&T's interactive editor. AT&T supports Cadence, Data I/O, Mentor, and Viewlogic for design entry, high-level synthesis and simulation.

Beta CAD tools will be available next quarter, with production tools expected fourth quarter. CAD li-

censing fees range from \$6,995 to \$14,995 for PC platforms, and from \$13,450 to \$21,450 for Sparcstations. Samples of the ORCA FPGA devices will be available fourth quarter. In 100-piece quantities, the ATT1C05 5,000-gate device in a 208-pin quad flatpack is priced at \$240, and the 11,000-gate ATT1C11 in a 304-pin quad flatpack is \$710.

—Barbara Tuck

### FPGA ORCA family at a glance

- From 3,000 to 20,000 gates
- From 120 to 288 I/Os
- Up to 80-MHz system clock rates
- Configurable lookup tables for optimized logic utilization
- Direct mapping to and from gate arrays and standard cells
- Pre- and post-layout timing analysis
- Hierarchical routing

### AT&T Microelectronics

555 Union Blvd  
Allentown, PA 18103  
(800) 372-2447 ext. 837

Circle 362

### Trademark Information

UNIX is a registered trademark of AT&T Bell Laboratories.

PAL is a registered trademark of Advanced Micro Devices, Inc.

SMART-POWER is a registered trademark of Nartron Corp.

CDA and BurstRAM are trademarks of Motorola, Inc.

SCOPE and ASSET are trademarks of Texas Instruments, Inc.

IRIS POWERVISION is a trademark of Silicon Graphics, Inc.

RealTimeX is a trademark of Concurrent Computer Corp.

Zone Bit Recording is a registered trademark of Seagate Technology, Inc.

# Spend three days at the '92 Embedded Systems Conference.

## Spend the year using what you learned.

**H**elpful. Inspiring. Top Notch. Excellent. These are just some of the words our past attendees use to describe the Embedded Systems Conference faculty. In just three days you'll find answers to the toughest questions you face presented by leaders in the embedded development community. Faculty who know your job is becoming more complex; who work everyday on real workable solutions to the toughest problems you face. People like Larry Constantine, Steve Mellor, Paul Ward, Derek Hatley, Imtiaz Pirbhai, P.J. Plauger, and Michael Slater.

### Build Your Own Program.

Customize your own program by choosing from over 75 lectures and workshops that cover a wide range of issues in embedded development. You'll get top notch advice on real-time programming, CASE and object-oriented methodologies, embedded project management, programming languages, debugging and algorithms and much more.

**THE FOURTH  
ANNUAL EMBEDDED SYSTEMS  
CONFERENCE**

**SEPTEMBER 21-24, 1992**

SANTA CLARA CONVENTION CENTER  
SANTA CLARA, CALIFORNIA



*Attendees can choose from over 75 technical sessions led by the leaders in embedded development.*

### Try Out The Latest Technology At The Embedded Systems Development Products Exhibition.

The Embedded Systems Conference will also be the site of the largest most highly targeted exhibition of embedded development products and services. Nowhere else will you find all the latest tools and utilities on display at one time.



*The Santa Clara Convention Center is conveniently located in the heart of Silicon Valley.*

### You'll Come Away With New Ideas That Translate Directly Into Increased Productivity.

Most importantly, the Embedded Systems Conference is a peer environment that fosters dynamic exchange of vital information, ideas, and insights. You'll find professional excellence throughout the conference; in the lectures and workshops, on the floor of the



*Over 120 exhibitors will be showcasing cutting edge tools and utilities.*

exposition, in the tutorials, and in informal receptions and hospitality events. And you'll get it all in three days.

### Phone us, fax us or mail us today for more information.

TEL: (415) 905-2354  
FAX: (415) 905-2220

**YES! Please send me more information about the Embedded Systems Conference.**

Name \_\_\_\_\_ Title \_\_\_\_\_

Company \_\_\_\_\_

Address \_\_\_\_\_

City \_\_\_\_\_ State \_\_\_\_\_ Zip \_\_\_\_\_

Phone (\_\_\_\_) \_\_\_\_\_ FAX (\_\_\_\_) \_\_\_\_\_

Send info on:  attending  exhibiting Please also send info to: \_\_\_\_\_

CDES

Mail or FAX to Embedded Systems Conference Miller Freeman Inc.  
P.O. Box 7843, San Francisco, CA 94120-7843 — TEL (415) 905-2354; FAX (415) 905-2220

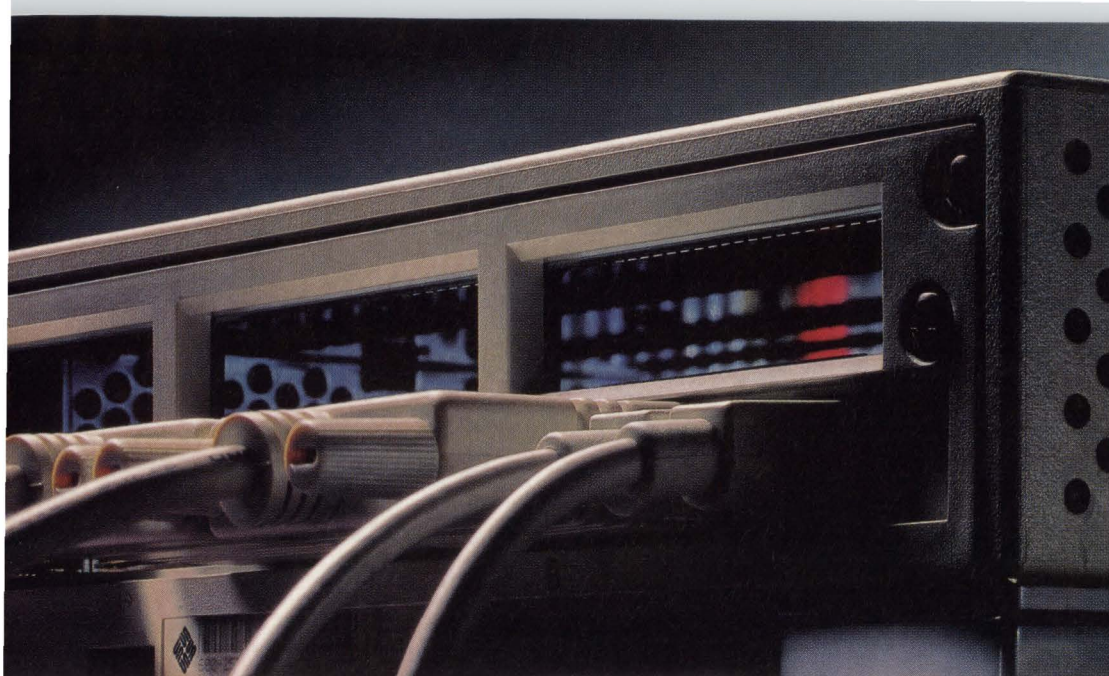

We also actively publicize third-party SBus products through our Catalyst<sup>SM</sup> marketing organization, the largest third-party vendor group in the workstation industry.

And we'll even help you with joint promotions, so you can get your product to market faster.

**We think you'd fit right in.**

Think about it. After all, you owe it to yourself to explore your options.

And while you're discovering what developing for SBus can do for you, remember you won't be the only one reaping the benefits.

So will the more than 350,000 SBus-based SPARCstation users worldwide.

Keep in mind, RISC/UNIX workstations are the fastest-growing segment of the computer industry in the '90s.

And that's just the beginning.

Besides SPARCstation systems, there are more than 20 other SPARC<sup>®</sup> compliant systems using the SBus architecture that you can take advantage of. So you're not at the mercy of a single vendor.

But what else would you expect from the company that pioneered open systems?

It all comes down to taking advantage of a strong business opportunity.

So when can you start?



**Sun Microsystems**  
*Computer Corporation*

A Sun Microsystems, Inc. Business

For more information on developing SBus cards, just call the Sun Microsystems Computer Corporation Catalyst Information Center at 415 336-0390.

# We're looking to fill a few key positions.

Building the world's best-selling workstations just wasn't good enough. We're always looking for ways to make the best even better.

That's where you fit in.

We're looking for developers who want to add even more functionality to our SPARCstation<sup>™</sup> systems. By designing for the leading I/O interconnect in the RISC/UNIX<sup>®</sup> marketplace—SBus.

What's in it for you?

A great business opportunity.

A chance to develop for the fastest-growing 32-bit bus architecture in the PC and workstation marketplace. Even faster than EISA, MCA, and NuBus.\*

And you get the freedom to do what you want.

Develop MIDI interfaces. Data acquisition cards. Or the most sophisticated JPEG or MPEG compression algorithms. It's entirely up to you.

**We make it easy for you to do something different.**

If you develop cards for PCs and Macintosh<sup>®</sup> systems, developing SBus

cards will definitely be a change—for the better.

For one thing, SBus specifications are complete and easy to understand. So you spend less time figuring out the specs and more time designing innovative products.

We also offer a prepackaged SBus Developer's Kit, giving you extensive hardware and software documentation and support to make designing SBus products that much easier.

Plus you can get technical support through our SBus tutorials, SunU courses, Sun Professional Services, and Interoperability Centers.

**Develop SBus cards, and forget the fees.**

Unlike most bus architectures, there are no licensing fees, porting fees, or royalties to pay for developing SBus cards.

In these times, that's a welcome change.

And SBus means low per-unit card cost, because it's optimized for highly integrated technologies. So compared to PC cards, SBus cards can give you better profit margins.

\*More than 52% CAGR revenue growth of SBus cards 1990-96. Market Intelligence Research Corp.

© 1992 Sun Microsystems, Inc. Sun, Sun Microsystems, the Sun logo, and Catalyst are trademarks or registered trademarks of Sun Microsystems, Inc. All SPARC trademarks, including the SCD Compliant logo, are trademarks or registered trademarks of SPARC International, Inc. SPARCstation is licensed exclusively to Sun Microsystems, Inc. Products bearing SPARC trademarks are based upon an architecture developed by Sun Microsystems, Inc. UNIX is a registered trademark of UNIX System Laboratories, Inc. Macintosh is a registered trademark of Apple Computer, Inc. All other product or service names mentioned herein are trademarks of their respective owners. This product is protected by one or more of the following U.S. patents: 4,777,485; 4,668,190; 4,527,232; 4,745,407; 4,679,041; 4,435,792; 4,719,569; 4,550,368 in addition to foreign patents and applications pending.



# SBus News<sup>®</sup>

Technology and Market Update for SBus Users and OEMs

## Sun hangs onto share of VME market

According to a recent survey by Venture Development Corporation (Boston, MA), Sun Microsystems of Mountain View, CA has an impressive 17.1 percent of the single-board computer market. This places the company behind only Motorola (Phoenix, AZ), which has a 26.8 percent market share, and ahead of Force Computers (Los Gatos, CA), with 9.6 percent. Peter Palm, director of board marketing at Sun, believes that the company will retain as much as—and perhaps more than—70 percent of its total board business as SBus, with the remainder shifting to Sparc-based VME products.

### Market divisions

“The market will be divided into roughly three areas,” says Palm. “Right off the bat, some 50 percent of those customers [using Sun products] will shift directly from VMEbus to SBus for I/O.” Many of these customers, he says, are more traditional embedded workstation users who’ll take advantage of the smaller SBus form factor to streamline their product designs.

“Another 20 percent of those currently using Sun SBCs,” continues Palm, “will eventually move over completely to SBus. However, because of a hesitancy to abandon VME, or because some VME functions may not yet be available on SBus, these users will remain on VME and use an SBus-to-VMEbus adapter. These users build systems where the packing considerations can be handled, and the performance penalties of the bus-to-bus adapters can be tolerated.”

Such adapters are available from a variety of manufacturers, among them Bit-3 (Minneapolis, MN) and Performance Technologies (Rochester, NY). “In fact,” according to Don Turrell, SBus

continued on page 132

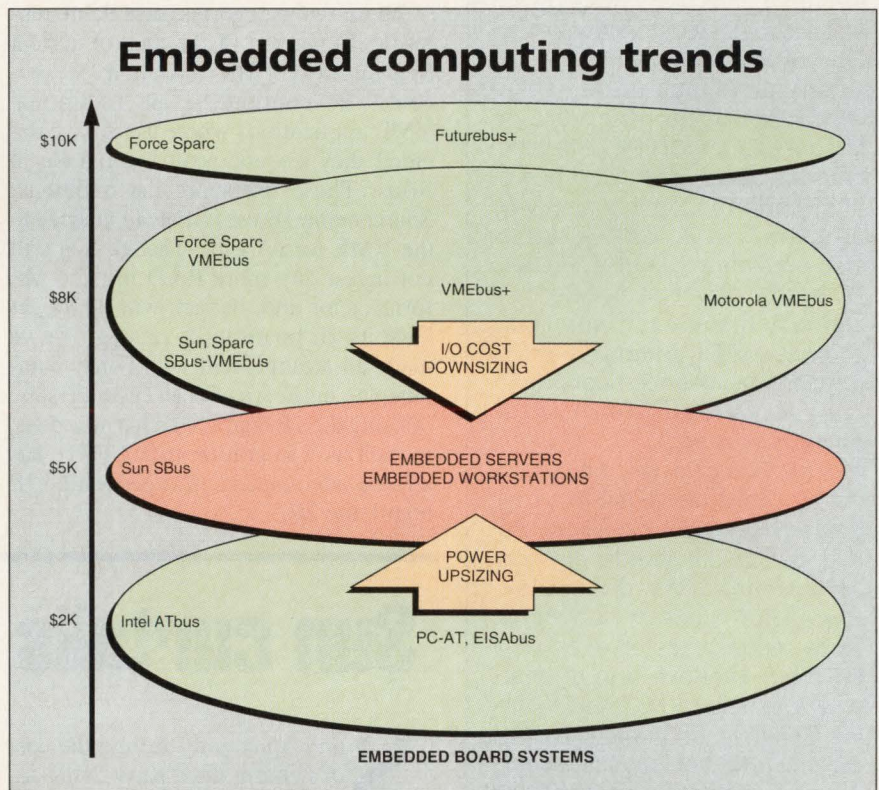

## SBus competition heats up

As a straightforward workstation bus, SBus holds the lead by a wide margin over its closest competitors, Turbochannel from Digital Equipment Corporation (Maynard, MA), and, to the extent that it can be separated from the personal computer market, MCA (Micro Channel Architecture). But the competition is heating up, with Turbochannel in particular making major gains. A handful of SBus developers are starting to see demand grow for Turbochannel, and they’re beginning to offer it as well as SBus option cards.

“Though SBus certainly has a lead in

the market now,” says Bill Kehret, president of Themis Computer (Pleasanton, CA). “Turbochannel has been growing steadily over the past several months. We see a need for Turbochannel hardware, particularly in the high-performance communication and networking arena.”

DEC also sees Turbochannel as being slightly behind SBus in the rankings, but believes it’s coming on strong. “We now count more than 400 members in our TRI/ADD program,” says DEC TRI/ADD communications director

continued on page 136

## Goldchip at alpha sites

**A**lthough the Motorola/Sun Goldchip won't be commercially available until sometime in August, a handful of companies have been busy with alpha site development projects. One of those companies is Chi Systems (Pleasanton, CA), which has been working with Sun to squeeze a full HiPPI interface onto an SBus card. "Sun has a high-performance connectivity problem," says Chi Systems vice-president Douglas Felder. "The only way that people can connect high-speed channels such as HiPPI to the Sun environment has been through VMEbus. SBus has not been much of an improvement."

"The Goldchip set, however," Felder continues, "lets SBus correlate much more closely to the real bandwidth needs of such communications channels." Since Sun doesn't support a block mode, transfer rates with the VME interface are, at best, only a couple of Mbytes/s. With the Goldchip, on the other hand, the first round of chips has been able to achieve rates of 80 Mbytes/s, and this will go to 160 Mbytes/s downstream. The basic HiPPI data rate is 100 Mbytes/s.

Chi Systems' SBus board is a major achievement in terms of board density, even though the finished board occupies two SBus slots. In addition to the Goldchip set, the board has to house the HiPPI chip set as well as the 100-pin HiPPI connector. "If we had to use discrete parts for the interface," Felder says, "it wouldn't have been possible to get everything on the board within either the real estate or power budget."

## Sun hangs on

continued from page 131

marketing head at Performance Technologies, "Performance was primarily a VMEbus maker and became involved in SBus by offering an SBus-to-VME adapter. Since then, Performance has experienced a rapid expansion of its SBus business."

Those two categories, says Palm, represent 70 percent of the total of current Sun business. "The remaining 30 percent," he continues, "are traditional VME applications where users have decided they do not want to upgrade to SBus. These users are the traditional Sparcengine 1E users that are married to the VME form factor. Though Sun will not invest any more R&D in the VME form factor and, in fact, will no longer have its 1E board in its catalog, we've made an arrangement with Force Computers to take care of such customers, by offering the 1E board, which it now does, as well as a migration path." Force has already announced a next-generation 1E board, the 2E.

The penalty for staying with the VME form factor and VME SBCs, instead of going to Sun Sparcstation motherboards with SBus I/O, according to Palm, is that VME users will be about a year behind Sparcstation performance levels. For example, Force's 2E board will be available this spring without the VME interface, and later in the year with the interface. Sun's Sparcstation 2 as a board-level part has been available for over a year. "And very soon," says Palm, "we will be announcing a more powerful machine. Sun will transfer this technology to Force, but it's expected to take about a year for it to ramp up."

### Upsizing and downsizing

In addition to hanging on to the bulk of its traditional business, Palm believes Sun, through its Sparcengines, will gain an increasing share of the embedded computer market because of the performance and small form factor of its product. Performance requirements in computing, graphics, networking, and other compute-intensive functions are forcing

continued on page 136

## Sun curtails support

**S**un's apparently feeling the cost of helping third-party SBus developers and has stopped accepting inquiries for SBus support. The company is suggesting that potential SBus product developers take advantage of some of the private consulting services available. Sun previously offered a full support package, including layout and design assistance for SBus vendors. In addition, it offered a full technical staff, the use of company workstations and a variety of software and hardware design assistance.

The program apparently did what was intended, attracting more than 100 SBus vendors offering more than 260 different SBus option cards. But the cost of such support—with the growing numbers of SBus users and vendors taking advantage of it—seems to have become unmanageable.

The company will continue to offer the SBus developer's kits and other support materials, but not the other support services. Included in the kit are the *SBulletin*, a quarterly publication with tips and hints for software and hardware development, and the *SBus Rule Book*, intended to guide designers. Further, has been quoted as saying that it's "very adept at anticipating problems and questions with forthcoming products from Sun, and is proactive about getting hints, tips and workarounds to users."

Says Sun's director of board marketing, Peter Palm, "There is now a network of third-party professional consultants available with the necessary expertise to help any SBus developer with any project. And while Sun cannot continue that support, the third-party consultants are trained professionals and have a going dialog with Sun." ●

## SBus gets tough

With its relatively compact form factor (about  $8\frac{1}{2} \times 11$  in.), the Sparcengine board and associated SBUS card is suited for a variety of military applications with a little hardening. Recently, a major contract was awarded Codar Technology (Longmont, CO) to provide Sun with ruggedized/Tempest Sparcstations and disk subsystems as part of a four-year Combat Air Forces Workstation (CAFWS) project.

Under the contract, Codar will supply its ruggedized/Tempest Sparcstation 2 with 28.5-Mips performance along with its 2.4-Gbyte disk storage subsystem. The company's Sparcstation 2 is enclosed in a ruggedized/Tempest system chassis and includes 32 Mbytes of memory, a GX graphics card, a ruggedized/Tempest 19-in. high-resolution color monitor, and a keyboard and mouse.

According to Steven McCann, Codar's manager of business development, "The new ruggedized Sparcstations comprise a Sun Sparcengine 2 motherboard with graphics SBUS card mounted on a special shock isolation tray which floats on an isolated platform." He says the Tempest unit carries all the

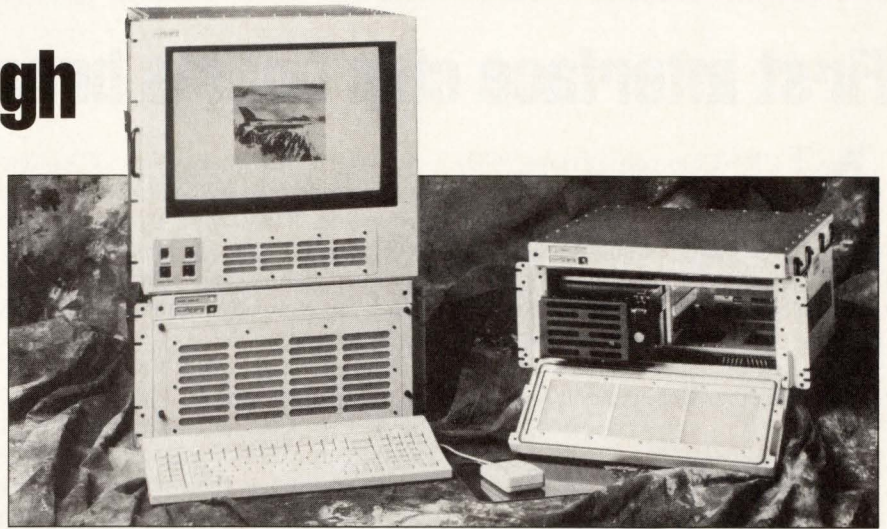

EMI and signal isolation, including EMI gasketing required for Tempest operation.

"Though the unit isn't qualified to full mil temperature range," says McCann, "it's designed to operate over a 0 to 50° C range. When we receive incoming boards, they go through a 100 percent AQL inspection and an environmental stress screening."

Similarly, the SBUS option boards included in these systems are thoroughly screened. "Currently," McCann says, "we use boards from Sun, Performance Technologies and Force."

And while the current contract—some \$48 million to the prime contractor,

Sun—has Codar busy, the company has some other exciting new products right out of the lab. One is a notebook Sparcstation, fully ruggedized and Tempest-compliant, using an active TFT matrix display. This unit will bring Sparcstation 2 power, complete with sophisticated graphics, to the battlefield.

In June the company also introduced a flat-screen monitor based on a new CRT developed by Zenith which uses a flat tension mask. In addition to the flat screen, which provides distortion-free images, the tube uses a finer dot pitch (0.26 mm instead of the conventional 0.31), which gives a brighter, clearer and higher-resolution image. ●

## Sparcengines serve broad application base

Sun Sparcengines and attendant SBUS I/O boards are being found in an increasing number of applications that have traditionally been the domain of backplane buses, PCs or proprietary designs. The combination of relatively low overall cost, compact form factor, rugged construction, versatile and inexpensive I/O, and flexible operating system have endeared SBUS to many who normally use other buses.

One of the fastest growing market segments is mission-critical data routing. These applications are found in routers and gateways as well as voice response systems that allow you to check bank and credit-card balances using your touch-

tone phone buttons. The Sparcengine/SBUS board is especially suitable for information routing because of its Unix multitasking environment and software-handling capability.

The size of the Sparcengine/SBUS board—about  $8\frac{1}{2} \times 11$  in.—has endeared it to customers requiring rugged construction. As a result it can handle many military C<sup>3</sup>I applications. And in medical imaging, Sparcengines have been designed in by the top three manufacturers of MRI and CAT scanners. The combination was selected for its power to handle complex imaging and the ease with which it provides complete networking capability.

On the factory floor, Sparcengine/SBUS solutions have been particularly successful in test machines—especially electronic test equipment—though some can also be found in power-plant and process control. And in computer-integrated manufacturing (CIM), Sparcengines, with their networking capability and available software, occupy a secure position. Factory automation systems are increasingly specifying more complex graphics displays, such as operator stands with multiple windows showing concurrently. New windows must be able to pop up if a process control parameter goes out of limits. Such applications

continued on page 136

## First interface chip boasts broad functionality

**N**CR (Colorado Springs, CO) has now joined LSI Logic (Milpitas, CA), Motorola (Phoenix, AZ) and Nimbus Technology (Santa Clara, CA) in offering SBus interface ICs. NCR's offering differs from the others in two ways, however: first, it's a chip set comprising two chips which can be used together or separately, and se-

***This chip set is a compact and inexpensive way to add a lot of functionality.***

Chris Cronan, NCR



cond, the chips provide specialized I/O functionality in addition to straight SBus interface and DMA.

"NCR's SBus chip set represents a major difference in direction from those existing products on the market," says Lyle Wallis, the company's director of chip set products. "While we do provide the SBus interface with second-generation DMA support, we will be the first chip vendor to also include a number of significant other functions."

The first of the two chips in the set is a full SBus controller, with an on-board DMA 2 controller supporting virtual address accessing and improved caching. In addition, the chip includes a 7990-compatible Ethernet controller core, a 53C90 fast SCSI core, a parallel port, counters, timers, an interrupt controller, and system reset logic.

The second chip contains only a minimal slave-only SBus interface along with other functions that wouldn't require the DMA function. These include a dual-channel 85C30-compatible serial controller, a high-speed 8277A-compatible floppy disk controller and hardware logic.

The chips are the result of a joint development effort by NCR and Sun Mi-

croSystems (Mountain View, CA), and will be marketed by NCR under license from Sun. They were developed as a collection of macrocells in NCR's standard cell library, and will be fabricated using the company's submicron CMOS process.

Chris Cronan, NCR's product manager for chip sets, says the chips will target two basic areas. First, makers of Sparcstation clones will want to use the chip set to supply the extra functionality to Sparcstation motherboards. Cronan didn't discuss whether or not Sun itself would be taking that approach. The second major area is add-on adapter boards. "Many adapter boards need additional functions, and this chip set is a

compact and inexpensive way to add a lot of functionality," says Cronan. A key word here is compact, since an SBus card is not much larger than a normal 3- x 5-in. file card.

Though the chip set has been designed, NCR is cautious about providing any release date and pricing at this time. "We've seen silicon, and it looks good," says Wallis, "but we're still a ways off from production." Wallis wouldn't let himself be pinned down on a date, but he indicated that the release date would be this year. He was even more indefinite about price. But the chips will be packed in 160-pin flatpacks and will probably be a sizable die—even using a submicron process. ●

### Spec Sightings

## Working group letter ballot complete

**I**EEE P1496 Working Group chairman Wayne Fischer reports that a significant step in the SBus standard approval process has been completed, and the group continues on schedule. "The core working group," he says, "has completed the initial task of converting Sun's SBus specification, Rev B.0, into a proposed IEEE standard." In the process, it worked its way through a number of problems encountered in turning the specification into IEEE language and settling some ambiguous points.

The standard then went out for a 30-day ballot, the returns of which were expected early in May. Comments received will be reviewed, and any updates to the draft will be completed for a possible 10-day recirculation of the draft. "Our plan is to start the official IEEE sponsor ballot on June 4," says Fischer. He optimistically feels that the balloting should be concluded by October 15—in time to submit the necessary paperwork to the IEEE to make P1496 a standard by year's end.

In tabulating the working group letter ballot, Fischer says the 75-percent rule is being invoked—75 percent of the returns must be affirmative, since some of the members have been unable to attend any working group meetings. At press time the ballots hadn't been tabulated, but Fischer reports that progress is steady and he anticipates no problems.

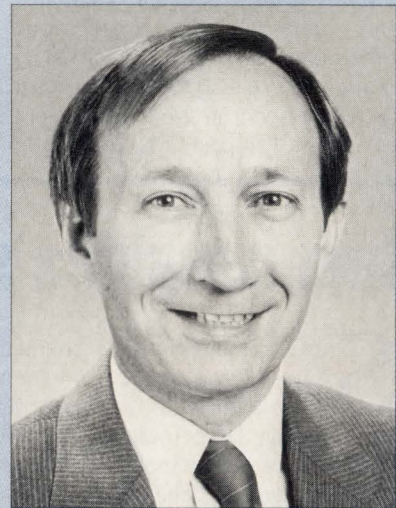

## DSP provides submicrosecond interrupt response

**Tony Agnello**  
President  
Ariel Corporation

**Michael Peck**  
President  
Berkeley Camera Engineering

While digital signal processors (DSPs) are probably best known for their high-speed multiply-accumulate capabilities, they're equally adept at performing high-speed I/O and interrupt processing. In fact, DSPs such as Motorola's DSP56001 can routinely achieve submicrosecond interrupt response times, more than an order of magnitude faster than conventional microprocessors such as the 68030.

### DSPs in space

Because of this high-speed I/O capability, DSPs are beginning to find their way into interrupt-intensive real-time applications that sometimes require no DSP processing in the conventional sense. The University of California at Berkeley Space Science Laboratory, for example, uses an Ariel DSP56001-based SBus board as a real-time controller for acquiring high-speed telemetry data from the Faust (Far-ultraviolet space telescope).

The Faust flew on board the space shuttle *Atlantis* between March 24 and April 2, 1992. Its mission was to electronically photograph a seven-degree area of the sky at far-ultraviolet wavelengths and telemeter the data back to earth. The Ariel boards were used as a real-time data-acquisition front end for a Sun Sparcstation 2 workstation, which was responsible for displaying and archiving the data to tape.

In operation, the DSP board receives telemetry data from the space shuttle as separate 4-Mbit/s and 56-Kbit/s streams. The 4-Mbit/s bitstream is used to relay photographic data at in excess of 80,000 photons/s. The 56-Kbit/s stream contains housekeeping information such as the instrument's position, voltage, currents, and temperature.

Upon receiving the data, a Xilinx gate array on the Ariel board parallelizes each data stream and signals the DSP. The DSP, in turn, executes an interrupt handler that reads the data a word at a time from the Xilinx chip, interleaves the two data streams, does some error checking, and moves the data into a buffer located in the board's 96-Kbyte local SRAM.

A Unix application that resides on the Sparcstation is responsible for emptying the DSP buffer, moving the data to a buffer on the Sparcstation and writing it to the tape drive. To do this, the application periodically issues read calls. In response, a Sparcstation-resident device driver configures an LSI Logic SBus DMA controller, which resides in the Ariel board; the DMA controller moves the data to a buffer in the Sparcstation's main memory. From there, the SCSI bus transfers data to a tape drive for archiving. Some of the data, such as instrument voltages, currents, and shuttle position, is also displayed in a window on the Sparcstation.

### Stiff real-time requirements

To keep pace with the two incoming data streams in real time, the system has to meet tight real-time constraints in two areas. First, it must be fast enough to move the data from the Xilinx controller to the DSP buffer. Second, it must be able to continuously empty the DSP buffer, move the data to a Sparcstation buffer and write the data to the tape drive.

To process the two incoming data streams, the DSP must be able to service two interrupts, one from each data stream every 4  $\mu$ s. The requirement makes it impractical to use most conventional microprocessors. A 25-MHz 68030, for example, requires 5  $\mu$ s just to respond to the interrupt, and that doesn't include the time required to execute the handler. If the 68030 uses a real-time OS such as pSOS to manage the handler, the interrupt latency increases to 13  $\mu$ s.

The DSP56001, by contrast, can respond to an interrupt in 300 ns. Moreover, the interrupt handlers for the 4-Mbit/s and 56-Kbit/s data streams require only 1.5  $\mu$ s and 1.0  $\mu$ s respectively.

As a result, the DSP can respond to and execute the handlers for both interrupts in less than 4  $\mu$ s.

The time DSP56001 can respond to interrupts much faster than conventional microprocessors for several reasons. One is that it doesn't have to save as much state information. When the DSP is interrupted, it needs to save only an accumulator and two registers, if resources can be dedicated to the interrupt handler. Another reason is that the DSP's interrupt vectors can contain two instruction words which can include six operations (one ALU and two data moves). As a result, short ISRs can be executed without branching to a separate handler. A third reason for the DSP56001's rapid response to interrupts is that it requires no real-time OS. A C program, which runs under Unix on the Sparcstation, controls the DSP, schedules tasks, invokes DSP-resident ISRs, and performs housekeeping tasks such as setup and buffer management by writing to the DSP's host command register.

To keep pace with the incoming data streams and avoid a buffer overflow, the system must also be capable of emptying the DSP board's buffer at the same rate that it's filled. The DSP requires about 200 ms to fill the buffer. To keep pace, the Unix system must issue and complete a new read call about 20 times per second.

### Unix tricky

Ensuring that Unix issues a new read call at any rate is tricky, because Unix is neither preemptive nor deterministic. The frequency at which it issues read calls is dependent on the other tasks that are running on the system and their relative priorities. To ensure that the data acquisition task is serviced on a regular basis, it's run as a -19 NICE superuser.

In tests done using the system configuration described for the Faust application, the average time between read calls was about 1.5  $\mu$ s. Even the worst-case time between read calls, which was about 50 to 100 ms, was well within the 200 ns required for the DSP to fill the buffer. ●

### SBus Competition

continued from page 131

Joan Peterson, "and more than 75 percent are directly involved in Turbochannel projects." One of the significant factors in Turbochannel's increase in market share, says Larry Robinson, software engineering manager for DEC's TRI/ADD program, is that DEC is trying to broaden Turbochannel's support.

"Originally," says Robinson, "we were a MIPS Ultrix-based support organization, but with Turbochannel starting to appear on some of the VAX platforms and being slated for future Alpha processor-based products, we're moving support into the VMS and OSF operating systems, into the realm of the other architectures—both VAX and Alpha."

Robinson reports that DEC has been busy increasing technical staff and trying to put in place support for those architectures. "There are already 46 Turbochannel products shipping," says Peterson, "fifteen of which are from DEC. These cover a broad spectrum, from communications and networking cards including Ethernet-, token ring- and ATM [Asynchronous Transfer Module]-based networks to a variety of bus adapters."

### Sparcengines

continued from page 133

need the full multitasking capability of Unix.

While the Sparcengine is being adopted into many such applications, it's not the only entrant. Certainly, in applications calling for multiprocessor functionality, the Sparcengine/SBus combination isn't easily used. Many other real-time applications also require software support that hasn't yet emerged in the Sparc environment. It's reported, however, that help is on the way in the form of a joint announcement from Lynx, the Posix-compatible RTOS developer, and Sun, with its own soon-to-be-released Solaris 2 OS, which reportedly has real-time capability. ●

"We're beginning to cover all the solutions," adds Robinson, "perhaps not in as much depth as SBus, but at least with critical option cards. What's important is that we have all the required solutions. For example, it's sufficient to have four or five serial communication cards—we don't need 20."

DEC is working to make sure all the critical areas are covered, either by the company itself or through third-party vendors. "We supply a constantly updated hot list of customer's requirements so third-party option card makers can address significant areas," says Sonia Fahey, North American recruiter for DEC's TRI/ADD program.

#### New developments

Turbochannel will probably be in even hotter pursuit of SBus in the near future as several new developments emerge. First, says Robinson, "We're in the process of completing our Turbochannel ASIC, which will serve as the front end

for option cards, replacing a handful of discrete cards." Second, the independent group of nine vendors now charged with maintaining the Turbochannel specification is discussing the possibility of increasing the data bandwidth of the approach, compatible with earlier versions.

Turbochannel can't take advantage of the approach used by Sun in its B.0 version of SBus, nor can it use the MCA or VME approach, where data is multiplexed over the address lines to effectively double bandwidth; this is because Turbochannel already multiplexes address and data lines to minimize pin count. Instead, faster Turbochannel cards will simply double the clock rate from 25 to 50 MHz. Compatibility will be maintained with earlier generations by encoding the configuration ROMs so that the system automatically transmits at the correct rate for each card. ●

### Sun hangs on

continued from page 132

users to upsize computer performance from PC AT, EISA, STD, and other devices. At the same time, many applications, from machine control to medical imaging systems, are looking for smaller form factors and lower power supply requirements than can be provided by traditional VME or Multibus systems.

"In addition," continues Palm, "those moving up are also looking to take advantage of more flexible operating systems. For example, many users are looking for the networking advantages of a Unix-type operating

system instead of DOS. And those looking to downsize from VME and Multibus II not only want to reduce the physical form factor, but the Sparcengine platform also lets them significantly reduce the cost of I/O through SBus."

What's precipitating much of this change is the use of specialized I/O chips and ASICs, which let many I/O functions reside on a single board with a mezzanine card handling any additional I/O. The very high volumes in the PC and workstation markets have significantly reduced the cost of these chips. Palm believes downsizing will have a significant impact on the traditional backplane-bus market. ●

*The next installment of **SBus News** will appear in the September issue of **Computer Design** magazine.*

**Watch for it!**

X.25  
PPP  
FRAME RELAY

# YOUR SUN'S WINDOW TO THE WORLD

## SXCM SBus High Speed Serial Controller

- X.25
- Frame Relay
- Point-to-Point Protocol
- Remote bridge for TCP/IP LAN traffic
- T1/CEPT rate
- 3 Channels
- Modular physical interface adaptation
- Extensive Communications Software



**THEMIS COMPUTER**  
Americas and Pacific Rim  
6681 Owens Drive  
Pleasanton, CA 94588  
Phone (510) 734-0870  
Fax (510) 734-0873

**THEMIS COMPUTER**  
Rest of World  
1, Rue Des Essarts  
Z.I. De Mayencin  
38610 Gieres, France  
Phone 33 76 59 60 61  
Fax 33 76 63 00 30

CIRCLE NO. 71

# The eggs *still* come first.

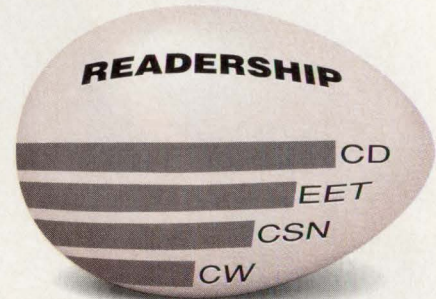
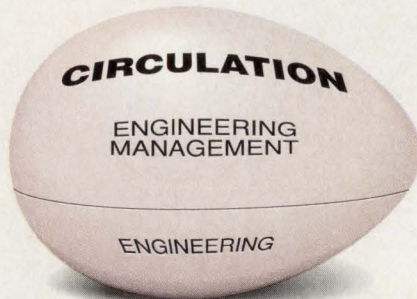
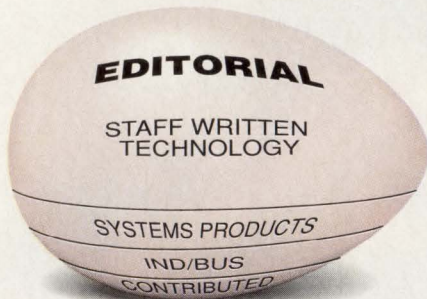

Last year we proudly ran the ad shown below. And again in '92, the eggs still come first — delivering value to our readers and advertisers that begins with editorial, circulation and readership.

The facts & figures in the first quarter of '92 illustrate our editorial commitment; we *increased* our editorial pages while most other publications decreased theirs.

More “why-to” editorial — strong, technology oriented editorial. Fully 66% of our editorial is technology driven. More on design choices, options and directions. Staff written, multi-vendor, multi-product essential editorial! Essential, to our 71% Engineering Management circulation. “Why-to” editorial is exactly what’s needed by Design &

Development Engineering Managers making the tough decisions on design tradeoffs and directions.

High Readership — “Why-to” editorial is why Computer Design wins readership among such important audiences as those senior technical trendsetters attending meetings such as the Invitational Computer Conferences. Among attendees

registering at all 1989 ICC conferences, Computer Design was first. And again in 1991, these attendees rated Computer Design #1.

“Why-to” editorial, the right circulation, and high readership means more ad pages.

The chart below shows Computer Design’s continued growth in ad pages for the 1st quarter of 1992. What it doesn’t show is our continued editorial commitment; an increase of 40% in editorial pages in the same time period. More than any other book in the market!

Ad pages are simply the score card.

So, the next time someone asks why Computer Design continues to do so well, remember —

**the eggs come first.**

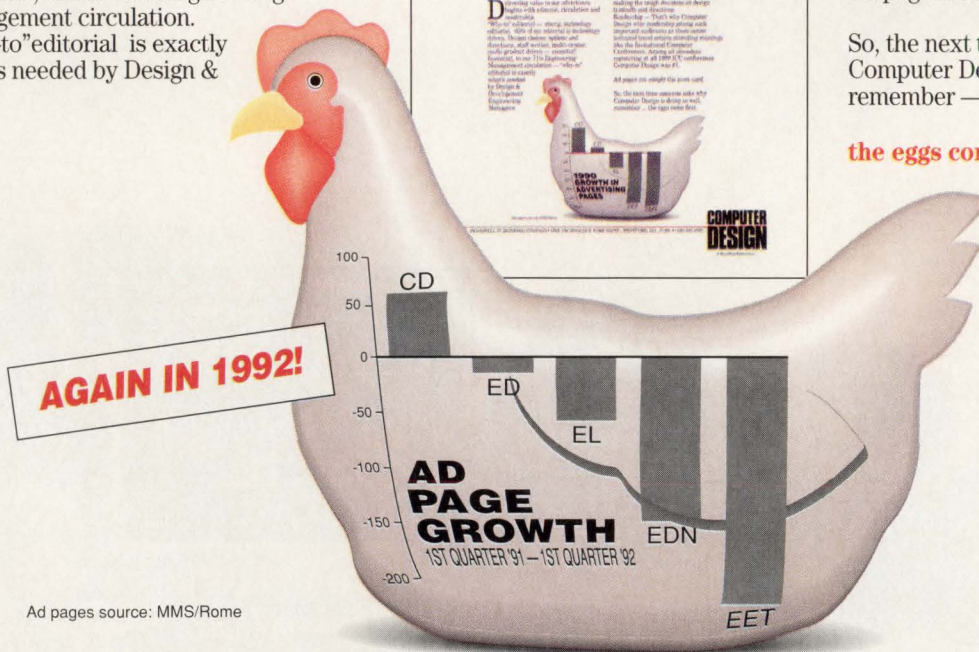

Ad pages source: MMS/Rome



## Analog behavioral simulation: not yet system-level

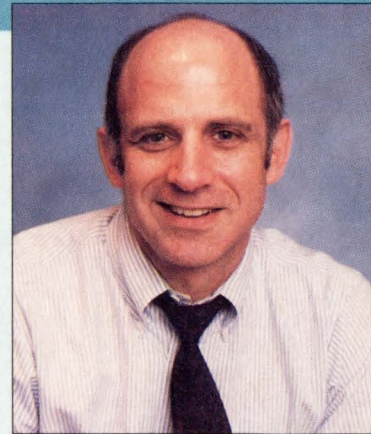

It seems to be getting it from both sides these days. On one side, people who work extensively with Spice believe I've overstated the case for high-level modeling. On the other, people in the forefront of abstract model development feel I've underestimated the physics and mathematics that go into behavioral modeling, even the streamlined models that offer simulation speedups.

I've suggested in earlier columns that analog must follow digital behavioral modeling in shifting its focus toward system-level activity and away from the physics of individual devices. While no one questions the direction I say we're going in, the "grand leap" I've projected for analog behavioral modeling—a separation between structure and function—will not occur anytime soon. The march toward a system-level description capability for analog and mixed-signal designs—an analog hardware description language (AHDL)—is inexorable, but it will be a long march.

### ■ AHDL years away

"AHDL won't be here for another four years," predicts Jim Solomon, president of the analog division of Cadence Design Systems (Santa Clara, CA). Until it comes, top-down design for analog will be limited. Without a synthesis capability, in fact, even top-down digital design is a questionable proposition, according to Solomon. More simulation work will be done on an intermediate level, for example, with Spice primitives. "We're above the physics level," Solomon points out, "but not that many levels up."

I've suggested many times before that if you're slinging 1s and 0s around, you can afford to be removed from the actual electronics that implement a digital circuit. If you're controlling voltages and currents, however, you must get much closer to the electronic devices that produce them. Much of the current behavioral model development, as a consequence, is taking place on a circuit level which remains fairly close to the transistor- and semiconductor device-level. This includes Saber model development by Analogy (Beaverton, OR), as well as Spice macromodeling efforts by companies such as Meta-Software (Campbell, CA) and Microsim

(Irvine, CA). This mid-level modeling effort is also the focus of Spice-compatible extensions from Electrical Engineering Software (EES—Santa Clara, CA) and Cadence Design Systems.

It's perhaps the 20-year marriage to Spice and other device-level modeling techniques that will effectively delay top-down design tools for analog. Because analog design is decidedly a bottom-up activity, mid-level modeling activity will remain interesting and important for some time to come.

### ■ No smart models for analog

While dedicated modeling companies such as Logic Automation (Beaverton, OR) have developed elaborate digital simulation models (Smart Models) for microprocessors, DSPs and math coprocessor components, there's little work on this level of integration in the analog and mixed-signal realms. The most integrated linear components in Analogy's model libraries, for example, are op amps and linear voltage regulators. Mixed-signal devices—analogue-to-digital and digital-to-analog converters, in particular—exist as templates and hypermodels which must be more fully developed by the user for particular applications. The majority of the 3,000-odd devices in the Saber model catalog, in fact, are diodes, small-signal transistors and analog renderings for 7400-series logic. Let's be clear about this: there's a considerable amount of complexity embodied in these models, because they view logic transitions over continuous time rather than as events occurring at discrete time intervals.

It's insufficient in analog terms, for example, to suggest that everything above 2.4 V is a logic 1 and everything below 0.9 V is a logic 0. We really need to see everything that happens to a voltage as it transitions from 0 to 1 and back again. Even a rectifier diode model will require considerable mathematical sophistication if its nonlinearities are to be modeled accurately. Whatever speedups over Spice have been attributed to Analogy's Saber simulator, Saber models utilize the same equation system—Modified Nodal Analysis. Despite their mathematical rigor, however, there's nothing among the Saber models that depicts

## MIXED-SIGNAL DESIGN

an IC with several thousand (or even several hundred) transistors.

A brief visit to a Saber users' group meeting in February, however, suggested that ever-higher levels of integration may not be among the highest priorities for analog and mixed-signal system designers. The modeling of electromechanical interfaces—the inductive kick from a motor coil, for example—was a major area of concern for the attendees of Assure '92, which included a high proportion of aerospace and automotive engineers. A proud new addition to the Saber device model library, in fact, is an IGBT, an insulated gate bipolar transistor. High-voltage, high-current IGBTs will be used as power driver transistors in all-electric cars—one of the most promising developments of this decade.

"Many engineers are simply looking for models of new devices that didn't exist before," suggests Kevin Walsh, president of EES. The thin-film transistors (TFT) used to illuminate new-generation LCD panels is one example. IGBTs are another. EES's Spice-compatible simulator, in fact, is being used by engineers at Ford to model the crosstalk generated by electrical arcing across the high-current switches of an automotive system.

"We tend to think of vehicles as complete systems," says Gary Zack, the technical specialist for analog simulation at Ford Motor Company (Dearborn, MI). "With just four or five lines of code, we can define an electromechanical extension to Spice primitives." Using both EES's Precise and Analogy's Saber, Zack's department generates models for sensors, relays and other electromechanical devices. An entire project, in fact, simulated the inrush current for lamps. "You need thermal models as well as electrical ones," says Zack. "You want to know what that lamp is going to do when you turn it on—whether it's a cold day in Minnesota or a hot one in Florida."

The availability of accurate models remains a key concern. Participants in a panel on modeling at last year's Analog and Mixed-Signal Design Conference agreed that there would always be considerable labor and expense involved in model development, but they were split as to whose job it should be. Stephen Parks, the bipolar ASIC product manager at AT&T Microelectronics (Reading, PA), expressed a view which should be typical of ASIC vendors, though it may not be. He said, "We're obligated to provide detailed models for our customers."

Hal Alles, corporate architect at Mentor Graphics (Beaverton, OR), however, said that CAE tool vendors can't be expected to provide models of devices and semiconductor processes. This sentiment was echoed in a recent conversation with Cadence's Solomon. "No CAD supplier can provide the models," he said, "the user has to do that." What the tool vendor can supply, however, is easy-to-use toolsets for model development.

### ■ Keys to the kingdom

The keys to a usable AHDL, it's becoming increasingly clear, reside with the tools for behavioral model development. There are several worth considering. Analogy's C-like Mast language, for example, is con-

sidered a candidate for an IEEE AHDL standard, and is being considered by the DARPA-funded MHDL (Mimic HDL) development group as a standard for microwave systems hardware. While not a formal language, Cadence's Profile is a Spice-compatible behavioral modeling extension which Solomon feels could easily be a subset (with the emphasis on subset) of a future AHDL standard.

Both Saber and Profile, however, are supported by what I'd classify as rudimentary graphical code generators. Both model generators provide a graphical environment in which you can describe transfer functions (or block-level elements such as amplifiers, comparators or phase-locked loops); you can also embed these descriptions with other device models in a full subsystem simulation. In the case of Saber, its graphical extension lets you quickly generate a model that can be used with other models in a Saber simulation. Profile does the same for Spice or Spectre.

While if/then/else software statements are typically required for any kind of interaction with digital system elements (i.e., for mixed-signal simulation), they're typically most distracting to an analog designer. However, they can be handled automatically by the model generator. The analog transfer functions, which are easier for the analog designer to specify, are entered in much the same way as solver statements or formulas are entered into the cells of a Lotus- or Quattro-type spreadsheet. To be sure, there's a little more work involved than evoking a graphics screen and filling in the parameters, but the description of transfer functions isn't as difficult as generating C code from scratch.

### ■ Models without programming

The graphical code generators serve as a partial response to the problem of generating behavior models without learning a software programming language. "Modeling is different than programming," maintains Eric Filseth, director of analog system marketing at Cadence. "Analog designers are language-resistant."

One can argue that Filseth is absolutely right; that analog designers don't feel comfortable with C-like programming constructs. One can also argue that most digitally-trained designers—who will, in fact, take more responsibility for analog and mixed-signal design in years to come—feel comfortable with high-level language constructs. I've certainly given voice to both viewpoints in this column.

"Top-down design depends on an analog hardware description language," Dr. Ian Getreu, Analogy's cofounder and vice-president of modeling, wrote in a technology trend piece. While few would challenge this statement, the open questions are: Which language? What level of abstraction? How much graphical support? It may be many years, in fact, before analog modeling moves beyond the middle level on which it's currently focused.

*Stephan Ohr is president of Indian Forest Research and editor of the monthly newsletter, Mixed Signals.*

# 1992 Computer Design Magazine UPCOMING ISSUES

Watch for these Special Features & Events in Computer Design Magazine —

	<b>SPECIAL REPORTS</b> <i>Comprehensive reviews and analyses of the major technology and design issues facing system designers and software developers.</i>	<b>TECHNOLOGY FOCUS</b> <i>Analyses of specific technology and product trends, and approaches to benchmarking, evaluating and selecting the optimum design solutions.</i>	<b>PRODUCT FOCUS</b> <i>Detailed review and comparative specifications for selected ICs, board-level products, design tools and software.</i>	<b>DESIGN STRATEGIES</b> <i>Analyses of the tradeoffs, options and design decisions made in developing a micro-processor-based product or system in a specific application area.</i>	<b>SHOW GUIDES</b> <i>Official value-added directories for major industry events.</i>
<b>JANUARY</b>	• Designing multimedia systems	• Top-down design methodologies and tools • CASE	• Specialty SRAMs	• Peripherals	• Buscon W
<b>FEBRUARY*</b> Buscon W,	• Multiprocessing architectures	• Benchmarking RISC performance • VHDL synthesis & simulation	• High-resolution D-A converters	• Medical diagnostics	
<b>MARCH</b> EI	• Emulating 32-bit processors	• Image processing in the bus environment • Memory design databases	• VMEbus CPUs	• Process control	
<b>APRIL*</b> IDEA '92, Comdex	<b>FUZZY LOGIC: SPECIAL REPORT ON FUTURE COMPUTING</b> • Choosing between PLD, FPGA and ASIC implementations	• Analyzing bus performance versus DSP in embedded applications	• C compilers	• Military systems	
<b>MAY</b> CICC	• Analog versus digital approaches to signal processing	• Intelligent power control • PCB design and layout	• RISC processors	• Instrumentation	
<b>JUNE*</b> DAC	• Integrating PC-based tools into the design environment	• I/O buses and interfacing • Advances in graphics ICs	• Real-time kernels and OS's	• Workstations	
<b>JULY</b>	• High-performance network interfaces	• Benchmarking digital and mixed-signal simulators • Evaluating optimizing compilers	• Logic analyzers	• Communications	
<b>AUGUST*</b>	• Designing high-speed digital systems	• Bus-based DSP systems • Multichip modules (MCMs)	• Op amps	• Networking	• BusconE
<b>SEPTEMBER</b> BusconE, ESP, ITC	• Object-oriented languages in real-time applications	• Futurebus+ and beyond • Designing ASICs for testability	• 16-bit microcontrollers	• Data acquisition	
<b>OCTOBER*</b> A&MS, EI, Comdex	<b>NEURAL COMPUTING: SPECIAL REPORT ON FUTURE COMPUTING</b> • Application-specific building blocks in mixed-signal ASICs	• Selecting PC/AT chip sets • Software-performance analysis	• High-speed A-D converters	• Imaging systems	• Analog & Mixed Signal
<b>NOVEMBER</b> Wescon, Autofact	• Designing for testability	• Mezzanine bus strategies • Advances in datacom ICs	• Emulators	• Robotics and automation	
<b>DECEMBER*</b>	• 32-bit processors in embedded applications	• Evaluating PLD design tools • Graphical user interfaces	• EISA CPU boards	• Automotive systems	

\*Starch Readership Research Issue

COMPUTER DESIGN • ONE TECHNOLOGY PARK DRIVE, WESTFORD, MA, 01886 • 508-692-0700 • FAX 508-692-7780

For more information, contact any of us ...

PUBLISHER: David L. Allen, 508-392-2111 • ASSOCIATE PUBLISHER: Tim L. Tobeck, 508-392-2116 • NATIONAL ACCOUNTS MANAGERS: WESTFORD, MA, Tim Pritchard, 508-392-2217 • SPRING, TX, Eric Jeter, 713-353-0309 • SAN JOSE, CA, Diane Palermo, 408-371-7551 • STRATEGIC ACCOUNTS REPRESENTATIVES: WESTFORD, MA, Sue Nawoichik, 508-392-2118 800-223-4259 • David Singer, 508-392-2109 800-223-4259 • INTERNATIONAL SALES OFFICES: SURREY, ENGLAND, David Round, 81-686-7655 • PARIS, FRANCE, Daniel R. Bernard, 1-39-14-6780 • MUNICH, GERMANY, Johann Bylek, 089-903-8806 • MILAN, ITALY, Luigi Rancati, 02-70-30-0088 • TOKYO, JAPAN, Toshio Equisa, 81-33-536-5404 • ASIA, AUSTRALIA, NEW ZEALAND, Tom Gorman, 852-833-2181

# COMPUTER DESIGN

A PennWell Publication

# SERIAL EEPROMs: ALL SHAPES, ALL SIZES, ALL 1.8 VOLTS

Atmel makes every key serial-interface EEPROM in the market today. And, we'll make tomorrow's. That's every configuration, every density, every package. We're the world's broadest supplier.

Our 1.8-volt serials will cut your power needs by 80 percent. They're perfect for anything portable or anything that uses batteries. (We make 5-volt serials too.)

We don't wear out easily. We guarantee 100,000 write cycles, tenfold more than most. And for just a little

more we'll guarantee one million.

Because of our manufacturing expertise, we are price competitive. Really competitive. We own a state-of-the-art U. S. fab, and are the industry leader in EEPROMs. We know what we're doing

and pass it on in a form that every purchasing agent loves.

So, if you're using serial EEPROMs, think about Atmel—we make them all. And, if you give us a call, we'll send you a few to try.

#### DENSITY

1K  
2K  
4K  
8K  
16K

#### INTERFACE

2 Wire (24Cxx)  
3 Wire (93Cxx)  
4 Wire (59Cxx)

#### VOLTAGES

1.8 Volts  
2.5 Volts  
2.7 Volts  
5.0 Volts

#### PACKAGES

8-pin PDIP (JEDEC)  
8-pin SOIC (EIAJ)  
8-Pin SOIC (JEDEC)  
14-pin SOIC (JEDEC)  
Micro-module  
Die



*The people who make the difference*

ATMEL CORPORATION  
2125 O'Neil Drive  
San Jose, CA 95131

Tel. 1-800-292-8635 (USA only)  
Tel. (408) 441-0311  
FAX (408) 436-4200

**IDA** INSTANT DATA ACCESS (IDA) DIAL (617) 494-8338 DOCUMENT NO. 1050

CIRCLE NO. 75

## Inside looking out



**F**or years I've watched as graphical user interfaces and operating systems have come and gone. While many have promised the world, none has delivered more than a small continent, and lack of widespread use and market momentum have kept most of these islands unto themselves.

Recently OS/2 held the most promise as a multi-tasking environment, but it never panned out. Crash after crash sent many would-be users back to the drawing board after being burned by spending money and time with development systems, compilers and procedures that lacked a well-implemented core.

Each new version of DOS has provided a few more features and hooks, but none has solved the problems of serious CAE developers. Even the latest incarnation, DOS 5.0, carries with it many of the older problems that have shackled the personal computer in tackling complicated engineering problems.

Programs running under DOS 5.0, for example, are still limited by segmented architecture to 640 kbytes of RAM, even though many device drivers and other programs are TSR (terminate-and-stay-resident) that can load in higher RAM. TSRs free up most of the 640 kbytes for program execution, especially since DOS 5.0 takes up less run-time RAM—but the 640 kbyte barrier still exists.

While DOS extenders from third-party companies have found ways around memory-related problems, they're expensive. CAE vendors don't want to foot the bill for an OEM solution to what they consider to be an inherent defect in the operating system, because such a solution may put their products in a higher price bracket. Moreover, DOS extenders don't solve some other important problems, such as those related to graphical and I/O device standards.

### ■ Real engineers don't use icons

I must admit that, as a power user, I don't like icons. True, it's sometimes a pain to remember a string of invocation switches and parameters, and it's often a hassle to traverse partitions and directories to get to a program while manipulating data in other files. But you get a strange feeling of accomplishment when you've filled up your command line buffer.

While icon-based shells are obviously simpler to use, they remove you a level or two from the actual

processing, and this can lead to sloppier operations. I like to know every file in my directory; I like to be able to delete unneeded device drivers and maintain my disks and files myself. While utilities will let me do that, even within an icon-based environment, less experienced computer users will quickly fill up their hard disks and won't know how to clean up their directories and files, since they typically won't go through the school of hard knocks.

But even apes must evolve, and I have to admit that icon-based user interfaces may have their place in the newest and up-and-coming Windows software from Microsoft—not because of the pretty screens or point-and-shoot operations, but because of the environment which they offer to software developers who want to pack a lot of punch in their software and still keep the price within reach of the average engineer.

### ■ Windows eases software development

Many of today's popular CAE vendors now provide or will provide Windows-based engineering software. Note that a truly native-mode non-Windows implementation will always outperform a Windows-based version of the same software as far as processing speed, graphics redraw speed and overall performance are concerned—and by a factor of 10 to 100 percent.

But Windows provides a higher platform upon which to stand. This is true, first, because the graphical environment is taken care of. Instead of having to write several—or even dozens—of special drivers for the many graphic card versions available for the PC, the CAE vendor depends on Windows to handle the graphics. It then becomes the graphic card manufacturer's responsibility to provide a Windows driver for that card. This leaves the CAE software vendors time to make their high-priority products better and more comprehensive.

The same is true with input devices such as mice, tablets and digitizers, as well as output devices such as printers. Note, however, that specialized, less popular equipment—plotters, PLD programmers, in-circuit emulators, and other equipment in unique or proprietary formats—may have to be coded into the CAE application. But Windows can make basic I/O device handling easier for software vendors.

## PCs IN DESIGN

More important is the ability of windows to overcome memory limitations. Through expanded and extended memory managers, Windows lets your programs use larger chunks of memory—as much memory, in fact, as you can stuff in your sockets. By handling swapping and even the virtualization of memory through disk usage, Windows lets you use many of the programs that couldn't be implemented without that extra memory.

But Windows applications are not the easiest to program and come with quite a bit of overhead. One programmer I spoke to gave an example. The standard function of resizing a window can be handled in different ways. An application can clip a graphic rendering at the borders of the resize, or it can scale the image. Each case must be taken into account separately, and each is not a trivial task.

This example points up both a benefit to users and a burden to programmers—the benefit being multiple ways to perform a task, and the burden being the multiple ways the task must be programmed. To effectively integrate into the Windows environment, then, requires an extensive familiarity with the Windows program and the many intricate and subtle case scenarios that a Windows application must deal with. This carries an entirely new overhead with it, one that's independent of the application.

As a result, many bugs may exist in a Windows program

which may not manifest themselves until a specific combination of operations occur. While these bugs will inevitably be nailed down, the burden of their debugging may ultimately lie with the user.

### ■ The rush to Windows is on

Windows-based CAE programs are now emerging at a rapid pace. But beware: while many programs may run under Windows, they may not be true Windows application programs. If the program runs directly from DOS, it's not a true Windows application, which can only run in the Windows environment.

Many FPGA design tools are finally taking advantage of the benefits of using a Windows operating environment. Altera, for example, provides

the MAX + Plus II software as a Windows application. So, too, is the Quicklogic pASIC Toolkit for the new family of FPGAs from that company. New on the block is Lattice, which is now starting to ship the pLSI Development System for its newly announced EEPROM-based FPGAs. Data I/O's popular Abel PLD and FPGA software is reportedly on Windows and soon to be shipping in Windows flavors. All of these systems can take advantage of the Windows clipboard for importing text and cutting and pasting around different files, as well as for using the big blocks of memory often required to tackle large PLD and FPGA designs.

Another nice feature of the Windows environment is that several independent but related windows can be open at the same time, showing schematics, logic equations, block diagrams, pinouts, prompts, status blocks, and other functions which used to be combined into one display in non-Windows applications. Here,

each subapplication can be resized, moved, closed, and reopened as a matter of user preference. This provides you with more flexibility, decreases learning time and supplies a more homogeneous work environment.

Schematic capture and PCB applications are also coming to Windows. Accel Technologies has already demonstrated a new 32-bit database version of its PCB package with increased resolution (down to 1  $\mu$ m) and 99 layers

of support. CAD Software will also be shipping its PCB design packages as a Windows application.

OrCAD and P-CAD are still waiting for a faster Windows (the up-and-coming Windows NT) before they migrate their schematic capture and PCB tools to Windows. Omaton's schematic capture and PCB tools will be on Windows soon, as will Futurenet schematic capture and Protel PCB, schematic capture and digital logic simulators.

One company that's always opted for the highest performance is Viewlogic. Before Windows, the company used DOS extenders to take advantage of deep memory arrays for large designs. Keep an eye out for a true Windows-based Workview to emerge from the company. This may be a more comprehensive pro-

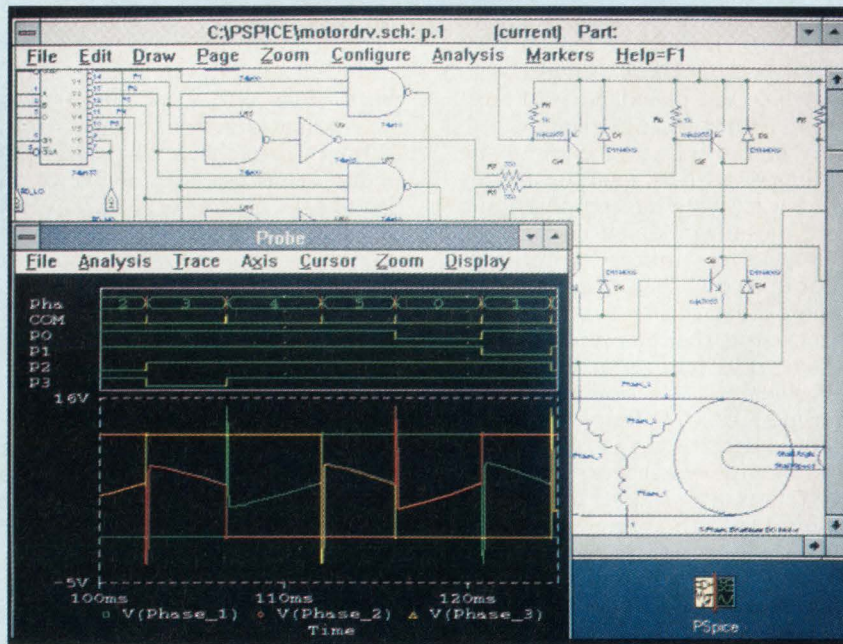

*The Windows version of pSpice provides the familiar Windows personality, letting you configure the working environment specifically to your application.*

## PCs IN DESIGN

gram, and it may even be less expensive than the original Workview, since the cost of the DOS extenders won't be passed along to users.

### ■ Something for the linear designers, too

While it may seem that linear simulation is too compute intensive to benefit from Windows, this may not be the case. Microsim has already shown a Windows-based schematic capture program for linear simulation and will soon provide its linear simulator and Probe waveform analyzer as Windows-based applications.

Deutsch Research is also using Windows for its Spicewindows Professional analog simulation software. The benefit of providing schematic windows with waveform windows is that it helps coordinate the debug, analyze, reiterate, and optimize processes, because they all can be running and displayed simultaneously.

Another area where Windows shines is in data acquisition and control. The new Lab Windows from National Instruments is a shining example of a Windows-based instrument monitoring, data gathering, display, and control application which really makes good use of the windowed environment. Until now, these tasks have been less graphic when performed on PCs, and they've consequently been left to Apple computers, which have always had a window-like environment with true multitasking.

True multitasking is still around the corner for Windows. And its pseudo-multitasking capabilities are limited, awkward and difficult to use. You may have to become an expert on Windows to take full advantage of the more advanced features. But while you're waiting for a simulation run you can be modifying the next source file or editing your documentation—all more slowly than each task would take by itself, but requiring that you take fewer coffee breaks overall.

### ■ Getting on a stronger horse

To really take advantage of these applications, a more powerful PC is required. While older XTs and 286 machines were fine for the days of Palasm, OrCAD,

Tango, and the like, the newer breed of software will require a full-blown 386- or 486-based machine. The ever-popular SX machines may still work but could introduce unacceptable delays. The 286 machines are out, since they can only run in the real mode and won't let you take advantage of the higher-level, enhanced 386 features—they're just too slow.

Windows still has a few problems to be solved. One important one has to do with peripheral device sharing and concurrent control by different processes. For example, we're always running out of serial ports. We may use a mouse, modem, plotter, in-circuit emulator, PROM programmer, PLD programmer, serial printer, and so on. Windows doesn't make direct provision for the external switchers and the multiplexers. This

holds true for all parallel ports, although not as critically because fewer devices use parallel port interfaces.

And finally, Windows isn't the only option anymore. Most CAE vendors who have traditionally stuck to PCs are now moving closer to Unix-based workstations.

This leads to a higher horsepower migration path while maintaining file compatibility with lower-cost PC-based design seats, it still represents a minor share of the engineering plat-

forms. During the last year, 286- and 386-based PCs still dominated the engineering workplace. The 486 will soon be right up there—the only reason it's not on top now is that 486 machines are still relatively new and have not yet fully penetrated the design labs.

Also, as more companies provide Unix operating systems for PCs, more designers will opt to go Unix. But DOS- and Windows-based operating environments will dominate for quite some time. The low prices of DOS and Windows make them too attractive for companies which are very conscious of cost and performance.

*Jon Gabay is a freelance editor with extensive design experience. He has written for all of the specialized CAE/CAD publications at one time or another, including High Performance Systems, Engineering Workstations and, most recently, Design Automation.*

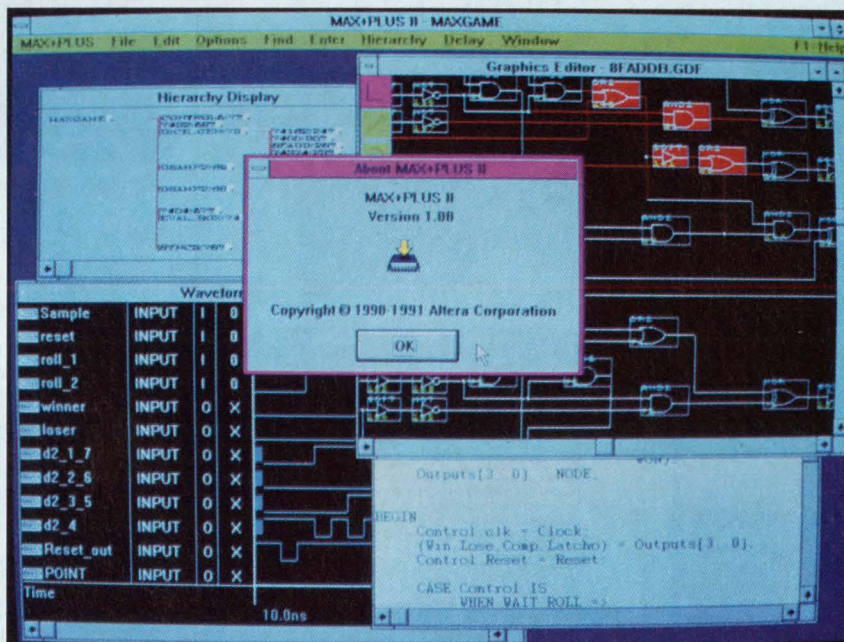

The MAX + Plus II lets you divide the screen, showing logic, equations, waveforms, and reports simultaneously. This speeds design iterations, since all editing can be done in a single environment rather than having to run and rerun each application.

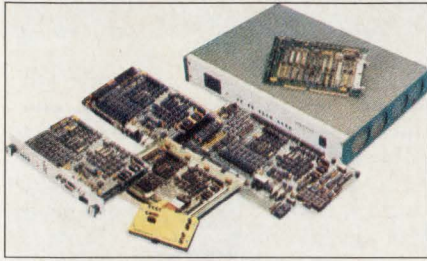

## REAL-TIME NETWORK

The SCRAMNet Network™ combines the real-time speed of replicated shared memory with the flexibility of a fiber optic LAN to get microsecond response from multi-vendor computers. It allows you to connect dissimilar computers at 150/Mbits/sec over fiber optics, with zero software overhead. This replicated shared memory network offers data filtering, programmable byte swapping, and a sophisticated interrupt structure.

### SYSTRAN CORP.

4126 Linden Avenue, Dayton, OH 45432-3068 USA.  
Phone (513) 252-5601 or 1-800-252-5601.

CIRCLE NO. 166

## 68HC16 68332

PC-based In-Circuit Emulator

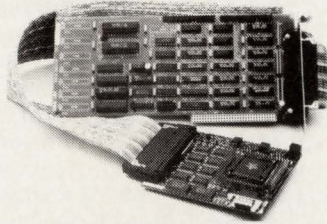

- Supports 68HC1621, 68331, 68332, 68340 with more members of the HC16 and 300 families to follow.
- User interface under Microsoft Windows.
- Memory contents available in real-time (shadow RAM).
- Up to 17 MHz real time emulation.
- Full control of TCNT at breaks and single step.
- High-level C support. In-line assembler and disassembler.
- 10-day free trials available to qualified customers.

**NOHAU**  
CORPORATION

51 E. Campbell Avenue  
Campbell, CA 95008  
FAX (408) 378-7869  
(408) 866-1820

CIRCLE NO. 167

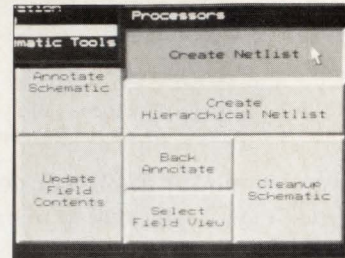

## IT CAN BE THIS EASY!

OrCAD's innovative ESP Framework can make creating a netlist from your schematic as easy as pressing an on-screen "button."

Call (503) 690-9881 for a **FREE** demonstration disk and information about the entire OrCAD product line: schematic design, simulation, pc board layout, programmable logic IC design and more.

CIRCLE NO. 168

## THE FIRST PC BASED PBX BOARD



- Handles 4 trunk lines and 12 telephones per board, expandable to 48 telephones per PC.
- Can program any telephone set to individual specifications.
- Standard PBX capabilities at a fraction of the cost.
- Concurrent operation with other PC programs.
- Easy to use menu driven screen displays.
- Integrates with voice mail, fax or modem cards.

QUANTITY & DEALER/OEM  
DISCOUNTS AVAILABLE

**PCBX**  
SYSTEMS, INC.

(800) 755-PCBX

TEL: (714) 668-1180  
FAX: (714) 668-0215  
3730 S. Susan St., Ste. 250  
Santa Ana, California 92704

CIRCLE NO. 169

## PC Bus Data Acquisition

...over 50 exciting hardware & software products!

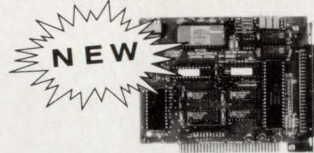

### AD1200 only \$359

- 12-bit 125 kHz A/D Conversion
- 16 Analog Input Channels
- 3 Timers and 16 DIO Lines
- Supports DMA and Pacer Clock
- AT Bus Version Available!

A/D, D/A, Digital I/O and Timer/Counters for PC XT and AT computers • 12-bit A/D rates to 200 kHz! • Eight boards for AMPRO form factor CPUs • 110 VAC relay, optoisolation, multiplexer and thermocouple boards • DSP and data acquisition software • Request your **FREE 80 page catalog today!**

**rttd** Real Time Devices, Inc.  
State College, PA USA

Tel.: 814/234-8087 • FAX: 814/234-5218

CIRCLE NO. 170

## REMOVE HARDWARE LOCKS

Protect your investment!

Don't wait for your lock to get lost, stolen or fail and render your program useless.

Our **SAFEKEY'S** are guaranteed to unlock the following:

PADS 2000    MAXROUTE    TOPAZ  
PADS PCB    MICROSTATION RIO  
SMARTCAM    3D STUDIO    & MORE

Limited Time Offer \$399 plus S&H

(609) 390-2799

24 HR. FAX HOTLINE

(609) 390-3750

## IMAGINE THAT

1 Evergreen Dr., Seaville, NJ 08230  
TM-Trademarks property of respective owners.

CIRCLE NO. 171

## MICROCONTROLLERS

- C Programmable
- Data Acquisition
- Control / Test
- Excellent Support
- From \$159 Qty 1
- New Keyboard Display Modules

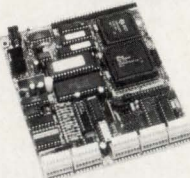

Use our **Little Giant™** and **Tiny Giant™** miniature controllers to computerize your product, plant or test department. Features built-in power supply, digital I/O to 48+ lines, serial I/O (RS232 / RS485), A/D converters to 20 bits, solenoid drivers, time of day clock, battery backed memory, watchdog, field wiring connectors, up to 8 X 40 LCD with graphics, and more! Our \$195 interactive **Dynamic C™** makes serious software development easy. You're only one phone call away from a total solution.

### Z-World Engineering

1724 Picasso Ave., Davis, CA 95616  
(916) 757-3737 Fax: (916) 753-5141  
Automatic Fax: (916) 753-0618  
(Call from your fax, request catalog #18)

CIRCLE NO. 172

## GUI FOR INTEL 8051 EMULATOR

Franklin Software's GUI Emulator Interface brings windows-like power to Intel and Nohau 8051 emulators at a special price--

**Special Offer: \$49.**

### Emulator Interface Features:

- Fast graphical user interface with Drop Down Menus.
- Default windows for code, data, and status information.
- Symbolic debugging of "C" or PL/M-51 code.
- "Watch Windows" trace variables, structures, etc.
- Supports all emulator functions and Intel/Nohau tools.
- Point & Shoot (Mouse) control of emulator and target.

For Intel and Nohau Emulator Customers Only.

**FRANKLIN**  
SOFTWARE, INC

Call (408) 296-8056 Ext. 431 for details.  
Please have your FAX number ready.

CIRCLE NO. 173

## Half size ECL Clock Oscillator



Connor-Winfield Corp. introduces its new 8-pin DIP ECL clock oscillators. The E500 Series is available in frequencies from 24 MHz - 180 MHz. Options available include industrial temp range of -40C to +85C, complimentary output, enable/disable function, and surface mount header. Frequency stabilities are available to +/-25 ppm over temperature.

These models are available with supply voltage of either -5.2 Vdc (10K equivalent) -4.5 Vdc (100k equivalent) or +5Vdc. Prototype quantity pricing at 120 MHz is \$43.90 each. Delivery is stock to 7 weeks A.R.O. Contact Barney Ill at: **Connor-Winfield Corporation** 1865 Selmarten Road, Aurora, IL 60505  
PH: (708) 851-4722    FAX: (708) 851-5040

CIRCLE NO. 174



# SYSTEM SHOWCASE



## FULLY INTEGRATED, RACK MOUNT AND RUGGED SUN SPARC WORK STATION

STANDARD FEATURES INCLUDE:

- SPARK ENGINE 2 CPU WITH 16MB RAM
- 2107MB HARD DISK, 150MB TAPE DRIVE
- 644MB CDROM, REMOVABLE HARD DISK
- 1.44MB FLOPPY, 2 RS-232 AND S BUS PORTS
- SCSI-2 AND ETHERNET INTERFACE
- 16 INCH RACK MOUNT COLOR MONITOR
- KEYBOARD, MOUSE AND SunOS 4.1

FOR CUSTOM CONFIGURATIONS AND FURTHER DETAILS CONTACT:

**IBI SYSTEMS INC.**  
6842 NW 20th AVE, FT. LAUDERDALE, FL 33309  
305-978-9225 FAX: 305-978-9226

CIRCLE NO. 175

## INDUSTRIAL PASSIVE BACKPLANES PC/AT/ISA

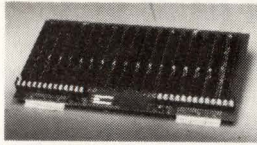

- Available in 3 to 20 Slot Configurations
- User Selectable "Tri-Mode" BUS Termination
- Multiple Power Connection Alternatives
- Industry Compatible Mounting Holes
- Solid State 5V Keyboard Power Protection
- Minimum 4 Layer FR4/94V UL Construction
- Optional Power Good Circuitry On Board
- Multi-Processor 18 and 20 Slot Backplanes
- User Selectable Segmentation
- Custom Design Capability
- Lifetime Warranty
- Made in USA



1729 Little Orchard St., San Jose, CA 95125  
Phone 408-971-0910 FAX 408-971-0763

CIRCLE NO. 176

## USE OUR READY TO ORDER EXPERTISE IN:

ANALOG AND MIXED SIGNAL  
ANALOG-DIGITAL INTEGRATED  
CIRCUIT DESIGN, DEVELOPMENT  
TESTING AND MANUFACTURING.

### TO:

- Reduce Costs • Safeguard Your R&D Investment
- Increase Reliability • Enhance Product Image
- Increase Manufacturability

TECHNOLOGIES	VOLTAGE/CURRENT/FREQUENCY CAPABILITY
CMOS Technology	Voltage: 1.5 to 500 Volts
BIPOlar Technology	Current: 100nA to 5 Amps
BICMOS Technology	Frequency: DC to 1 Ghz

POWER ELECTRONICS	TELECOMMUNICATIONS	SIGNAL PROCESSING
CONTROL CIRCUITS	FILTERS	INSTRUMENTATION
COMPUTER PERIPHERALS	DATA TRANSMISSION	INTERFACE

STANDARD PRODUCTS BREADBOARD PARTS STANDARD CELL LIBRARIES  
ANALOG ARRAYS ANALOG-DIGITAL ARRAYS LOW COST PROTOTYPING  
CONSULTATIVE ASSISTANCE ONE STOP SHOPPING SYSTEMS EXPERTISE

**SPG** SIGNAL PROCESSING GROUP  
401 N. Alma School Rd., M.S.#9,  
Chandler, AZ 85224  
Ph: (602) 786-1197 Fax: (602) 821-2472

CIRCLE NO. 177

## EPROM PROGRAMMER



- Quick pulse pgrams. eight 1 Mbit EPROMs in 40 sec.
- Stand-alone or PC-driven
- RS-232, parallel in & out ports
- Binary, Intel hex, & Motorola S formats
- 100 user-definable macros
- Information, call (916) 924-8037
- 1 Megabit of DRAM
- Made in U.S.A.
- A9 Identifier
- 2 year warranty
- Single pgmr. \$550

### NEEDHAM'S ELECTRONICS

4539 Orange Grove Ave. • Sacramento, CA 95841  
(M-F, 8-5 PST)



CIRCLE NO. 178

## VME "HOT HARDWARE" FROM MATRIX

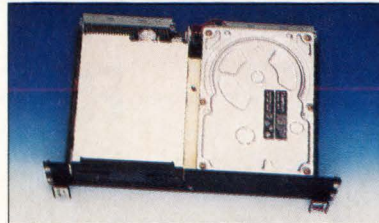

### The DSM (Data Storage Module) for high-performance real-time systems.

- 2-slot mass storage solution
- Self-contained, no external wiring
- Integrated VMEbus disk drive controller
- Floppy or SCSI drives or combination of both
- Up to 200 Mbytes of data



### The DB-PCOMM high-speed 32-bit Parallel Communications Module.

- Data transfer rates above 30 Mbytes/sec
- VSB interface data path
- Synchronous or asynchronous data transfers
- DMA controller manages continuous, random, and block transfers



1203 New Hope Road, Raleigh, NC 27610  
Phone: (800) 848-2330, FAX: (919) 231-8001

CIRCLE NO. 180

## QUICK-TURN PC BOARDS

INSTANT QUOTES

1-800-234-1556

(After Hours (602) 377-7319)

Single/Double Sided/Multi-Layer  
Gerber Input/Floppy or Modem



### AVANTI CIRCUITS, INC.



17650 North 25th Avenue  
Phoenix, Arizona 85023

(602) 863-7729 & 234-1556

Fax (602) 375-1909

BBS/Modem (602) 234-1737

CIRCLE NO. 181

## ORCAD OFFERS DESIGN POWER FOR DOS AND UNIX USERS

Our DOS-based *Schematic Design Tools* are known for being the best price/performance value in the EDA industry. With the introduction of OrCAD's new line of UNIX® based products for the Sun SPARCstation™, OrCAD defines a new standard for ease-of-use, power, and value. Call (503) 690-9881 for information.



CIRCLE NO. 182

## CMOS 186

Single Board Computer

Runs C or QuickBASIC™ Programs

Powerful 16-bit computer directly executes EPROM's containing any C or BASIC .EXE file. NO LOCATORS! Software includes multi-tasking, multi-drop comm, PID control, OPTOMUX™

- 10, 12, 16 MHz 80C186
- CMOS design
- 512K RAM
- 384K EPROM
- STD BUS Expansion
- COM1 RS232/485
- COM2, LPT1
- RTC Avail
- 80C187 Avail
- OEM discounts

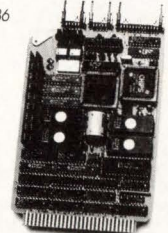

**MICRO/SYS**

3447 Ocean View, Glendale, CA 91208  
(818) 244-4600 FAX (818) 244-4246

CIRCLE NO. 183



## 357 MHz 14-Pin Clock Oscillator

Connor-Winfield Corp. announces literature on a new line of high frequency ECL Logic clock oscillators. The ECLB Series oscillator covers the high frequency range of 8 MHz-360 MHz. AVAILABLE NOW IN A 14-PIN DIP. Literature for a double DIP version with frequencies to 500 MHz is also available. Frequencies to 90 MHz are now available with Voltage Control function (model EV53 series). Contact Barney Ill for details.

Additional specifications listed below:

Model : ECLB  
 Package : 14-pin DIP  
 Frequency: 8 MHz to 360 MHz  
 Supply : -5.2 or -4.5 Vdc

## Connor-Winfield Corporation

1865 Selmarten Road  
 Aurora, IL 60505  
 PH: (708) 851-4722 FAX: (708) 851-5040

CIRCLE NO. 184

## FINALLY

**One** tool to satisfy all your firmware development needs

**PROMICE** is a universal system.

- Develops code for any microprocessor
- Complete, real time, source level debugging
- Host software for DOS, Unix, Mac, VMS
- Non intrusive on your target system
- Simply plugs into any ROM socket

**PROMICE** also supports Turbo Debugger, C. thru\_ROM, FreeForm, GDB, and more.

**PROMICE**  
 ...the affordable solution.



TEL: (614)471-1113  
 West: (415)750-0219  
 FAX: (614)475-6871

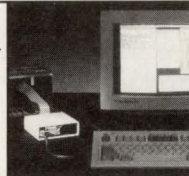

CIRCLE NO. 185

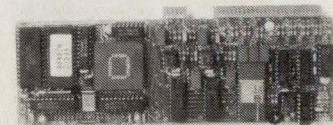
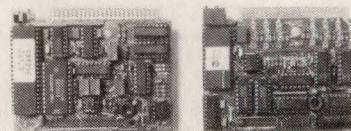

## SBX ANALOG I/O GET A COMPETITIVE EDGE!

**Density** - up to 16 A/D inputs & 8 D/A outputs on one single width card. **Speed** - throughput rates up to 59 kHz. **Intelligence** - many preprogrammed modes. Input filters, prog. gain amps, sample-holds, FIFO I/O buffers & many other features too numerous to mention here.

### ROBOTROL CORP

925 W. San Martin Ave, PO Box 990  
 San Martin, CA 95046  
 (408) 683-2000

CIRCLE NO. 186

## T-10 UNIVERSAL PROGRAMMER

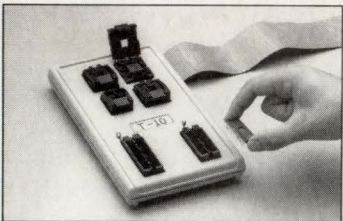

### EPROM ■ PLD ■ Bipolar PROM

- Built-in LCC & SMT ZIF sockets to 44 pins
- Individual pin driving
- Point & shoot menus, with MOUSE support
- Device updates on disk & BBS
- Built-in margin testing
- Vector testing
- User definable test parameters
- Full screen editing in 21 formats
- Intelligent identifier

**SUNRISE ELECTRONICS, INC.**  
 524 S. Vermont Ave. ■ Glendora, CA 91740

(818) 914-1926

CIRCLE NO. 187

## Z80 STD USERS!

**Cost Effective Upgrade  
 Clock Speeds to 10 MHz  
 1 Mbyte On-board Memory**

Increase your system performance and reliability while reducing your costs by replacing three of the existing cards in your system with one **Superintegrated Z80 Card** from Zwick Systems.

A **Superintegrated Card** in your system protects your software investment, requiring only minor changes to your mature Z80 code. You can increase your processing performance by up to 300 percent in a matter of days!

Approximately 35 % of each **Superintegrated Card** has been reserved for custom I/O functions including A/D, D/A, Industrial I/O, Parallel Ports, Serial Ports, Fax and Data Modems or almost any other form of I/O that you are currently using.

Call or Fax today for complete information on this exciting new line of **Superintegrated Cards** and upgrade your system the easy way!

**ZWICK SYSTEMS INC.**  
 Tel 613-726-1377, Fax 613-726-1902

CIRCLE NO. 189

# "FUZZY LOGIC" REPRINTS

Last year our March special report on **Fuzzy Logic** generated over **4,100 reader inquiries** and the **April 1992 Fuzzy Logic report** is already poised to generate an even higher number of inquiries! **Reprints of the April article are available now**—quantities of 100 or less are \$1.00 each, quantities over 100 are .75 each. To order, call Patti Kenney at (508) 392-2124.

# COMPUTER DESIGN

*Technology  
 and Design  
 Directions*

CIRCLE NO. 188

**THIS MONTH'S COVER:**

*The PC and compatibles have become powerful CAE/CAD platforms and there's a wealth of software packages available to designers. The cover highlights a few, but we've thrown in a couple of ringers. Can you find them?*

In the March 1992 issue of *Computer Design*, your Special Report by Jeffrey Child refers to Step Engineering's Express emulator in a very unfavorable light. A customer is referenced criticizing the user interface, and a comment is made about a Windows front-end that ameliorates the problem. The reporting infers that this statement is representative of Step's machine, and erroneously infers that our Windows front-end is a mere replacement for Exmon, which is a Nindy-like interface, familiar to many designers using Intel parts.

In fact, the reference to Peerless as a typical customer is pretty far afield. Peerless was an early adopter of i960CA architecture, using the B-step version of the part. In addition, the early work with the Express emulator was done using an early beta version of the machine. The company also found it feasible to buy a second unit within 90 days of receiving the beta loaner, since it was the only emulation equipment available from July 1990 to about June 1991.

Peerless was also working with early silicon, and much of the chip-emulator interface wasn't fully debugged. The combination of non-working target, an early version of Express and an early revision of the chip made progress slower than might be expected compared to using a mature part and mature support of a relatively new architecture.

Two of the functions that the Express performed and still provides are an execution history with the cache turned on and the ability to set a hardware breakpoint on a cached instruction. These functions were a leap forward from anything else available. The price for these first units was below \$15,000, accounting for the skinny feature set and the cryptic user interface.

Peerless stopped using the Express somewhere around November or December of 1990.

In March 1991, Step began shipping an integrated source-level debugger, SDBug, with its Express products.

This debugger uses Microsoft Windows as a GUI. This is a much more capable product than just an emulator front-end. It provides the full functionality of a source-level debugger—steps a C line at a time; sets software breakpoints symbolically; displays source code; spawns a watch window for looking at program variables, arrays and structures in native or alternative formats; displays registers at each breakpoint; shows stack information, source code scoping and much more. Its just like the most competitive debuggers on the market.

It has taken a while to round out a state-of-the-art emulator running at 40 MHz, providing full-feature capabilities for a superscalar, cache-based, 32-bit architecture. Step has been supporting these designs from the beginning, and continues to expand its products to provide increasing levels of productivity.

Peerless had special needs, was an early adopter of the chip and

emulator, did not take advantage of upgrade opportunities, and hadn't used the emulator for over one year from the time of publication of the article. Couching its input as a typical response, and not allowing Step to respond in the report, did not follow through on the 'when,' 'where' and 'why' of the reporting process. The result has been an unfair representation of Step and Step products.

Kerry W. Pike  
Director of marketing  
Step Engineering

[The Editor-in-Chief replies.] In an effort to break the one-way flow of communication—from vendor to reader—that has traditionally characterized electronics design publications, we began about a year ago to aggressively pursue input from designers, users and readers of *Computer Design*. *Our editors now routinely talk to several users for each article they do, choosing them*

**LEISTER****Contact-free soldering and de-soldering**

Of SMD, DIP and pin grid components and connectors in a matter of seconds with the Leister-Labor "S" hot-air tool. Electronic control of temperature and air supply, ESD safe. Over 400 special nozzles available.

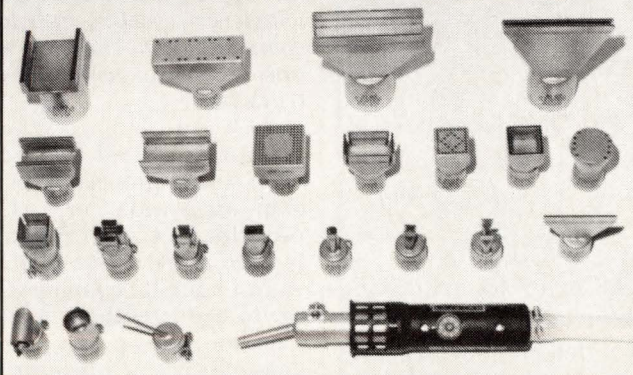
**Ask for free brochure UW 154**

Brian R. White Co., Inc., 313 Henry Station Road  
Ukiah, CA 95482  
Farmingdale, NJ 07727

phone: (707) 462-9795  
phone: (908) 938-2700

CIRCLE NO. 76

# 40 MB/SEC DUAL-PORT VME/VSB HIGH-DENSITY MEMORY

from  
**Chrislin Industries, Inc.**  
Your  
**TOP QUALITY Memory Supplier**  
for  
**OVER 16 YEARS**

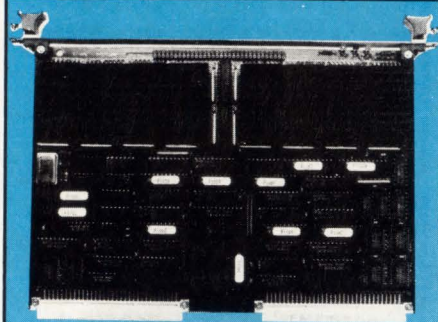

## CI-VME40

- FAST ACCESS TIMES**  
20ns READ/WRITE BLOCK CYCLE
- FAST CYCLE TIMES**  
83/62NS READ/WRITE BLOCK CYCLE
- VERSATILE CONFIGURATIONS**  
4, 8, 16, 32 or 64MB in one 6U slot
- VERSATILE ADDRESSING**  
Addressable in 24 or 32 bit through  
4 Gigabytes  
Memory start and end addresses  
selectable on 256kb boundaries  
VME/VSB configured independently
- RELIABLE**  
VME Revision C.1 Compatibility
- LIFETIME WARRANTY**

**OTHER QUALITY VMEbus  
MEMORIES AVAILABLE ARE:**

**THE CI-VMEemory**  
LOW-COST VMEbus BYTE  
PARITY MEMORY with 4, 8, or  
16MB in one 6U VMEbus slot

**THE CI-VSB EDC**  
Dual-port VMEbus/VSB memory  
with Error Detection and Correction,  
single-bit error detection/correction,  
double-bit error detection, 4MB up  
to 64MB in one VMEbus/VSB slot



**Chrislin Industries, Inc.**

31312 Via Colinas, Suite 108  
Westlake Village, CA 91362

TEL: (818) 991-2254 FAX: (818) 991-3490

**CALL TOLL FREE: (800) 468-0736**

CIRCLE NO. 77

## LETTERS

### LETTERS, COVERS & OTHER DIVERSIONS

*from names given to us by vendors, from our subscriber list and by calling companies that they believe might be users of the technology or products that are the focus of an article. It's obvious that an editor can't conduct a comprehensive user survey for every article he or she is writing and so tries to determine, during the interview, whether the user is knowledgeable and experienced enough to speak with authority. Even though the user may be knowledgeable and experienced, as was the case with Peerless, there's still a chance that his or her views may not be typical for a variety of reasons; the reasons here were that the experiences being related were a special case, and even worse, were badly out of date. That Jeff failed to uncover these two important facts was an oversight for which he has been duly chastised, and for which both Jeff and I apologize.*

*From the day we began to gather input from users and readers we knew that we'd run into problems if the comments, observations and assessments we received from users were negative and potentially damaging to a vendor or supplier. We believe, however, that user input is so important that we can't let this deter us. To minimize these problems in the future, every Computer Design editor will give any vendor or supplier whose product(s) may be cast in an unfavorable light the opportunity to respond to what's been said. If we believe a user's comments are valid, we're going to publish them. We'll try, whenever possible, to balance those comments with the vendor's response and let the reader decide where the truth lies.*

I am flattered that you [Steve Ohr] would propose to put me on a chip—or a wafer, or a platter, or a pedestal. But I think you are proposing too ambitious a plan when you want to distill down my wisdom and try to use it without me (see "CAE tools for analog: just interesting or essential?", *Computer Design*, March 1992, p 131). I don't think it's really feasible to take any experienced person, and take all his ideas, and then say that you can use that knowledge in a computer, to be as smart as he is. Isn't that what the expert systems have proposed to do? I think they are not overwhelming

successes. I think you need intelligent people to interpret and adapt good ideas.

For example, I have written a book on troubleshooting analog circuits, *Troubleshooting Analog Circuits* (Butterworth-Heinemann). I spilled out in this book all of the good ideas that I and my friends had—how to solve (or, better yet, avoid) problems with linear circuits. For a mere \$35.00 or so, you, too, can take advantage of this wisdom. But I don't think you can just put that book in a computer, and let the computer do the job. You need intelligent engineers and technicians to ask the right questions and measure the right data before you can even tell which part of the book may be helpful. Requiring a computer to do all the work is not going in the right direction.

Human judgment and experience are the necessary ingredients, either to solve a problem and get out of trouble or to design a circuit that just works and does not get you in trouble in the first place. I agree that computers can be useful tools to help a wise designer, but when they take their own steering wheels and try to drive themselves, they often crash and burn. So I think that kidnapping Bob Pease is not likely to be a profitable deal, but using the circuits he has designed, is likely to be....

Robert A. Pease  
Staff Scientist  
National Semiconductor

In the design of a computer, the most admirable innovation and skill is displayed in hiding its power switch in a different and most unexpected location.

Nick Atakkaan

## ADVERTISERS INDEX

ADVERTISER	PAGE NO.	CIRCLE NO.	ADVERTISER	PAGE NO.	CIRCLE NO.																								
<b>A</b>			<b>N</b>																										
Advanced Micro Devices	20-21	15	National Semiconductor	17	—																								
Advanced Micro Devices	26-27	17	National Semiconductor	32A	—																								
Alacron	16	9	National Semiconductor	62-63	—																								
Alslys	13	7	Needham's Electronics	147	178																								
American Eltec	79	47	Newbridge Microsystems	34	23																								
AMP	88-89	51	Nohau Corporation	146	167																								
Analog & Mixed Signal			<b>O</b>																										
Conf.	112-113	59	Oasys, Inc.	47	34																								
AP Labs	16	10	OrCAD Systems	146	168																								
Applied Microsystems	80-81	48	OrCAD Systems	147	182																								
ATMEL	142	75	<b>P</b>																										
Avanti Circuits	147	181	P-CAD	85	50																								
<b>B</b>			PCBX Systems, Inc.	146	169																								
Brooktree Corp.	29	—	<b>Q</b>																										
BUSCON '92 East	115	61	Qualogy, Inc.	104	56																								
<b>C</b>			Quantum Software Systems, Ltd.	45	32																								
Canon USA	69	43	<b>R</b>																										
CheckMate Systems	114	64	Racal-Redac	82	49																								
Chrislin Industries	150	77	RadiSys Corporation	15	8																								
Ciprico	CV2	1	Radstone Technology	61	41																								
+ Computer Design	101	55	Real Time Devices	146	170																								
Computer Design	119	65	Robotrol Corporation	148	186																								
Computer Design	138	72	RTMX Uniflex	18	13																								
Connor-Winfield Corp.	146	174	<b>S</b>																										
Connor-Winfield Corp.	148	184	SBE, Inc.	CV3	80																								
CSPi	46	33	Software Development Systems	38	26																								
Cyclone Microsystems	19	14	Sophia Systems	103	—																								
Cypress Semiconductor	CV4	—	Spectrum Signal Processing	52-53	37																								
<b>D</b>			Sun Microsystems	130	70																								
Digital Equipment Corp.	6-7	81	Sunrise Electronics	148	187																								
Digital Equipment Corp.	97	82	Synergy Microsystems	2	3																								
Duracell	98	53	Synopsys, Inc.	55	38																								
Dyna Five Corp.	30	20	Signal Processing Group	147	177																								
Dynatem, Inc.	93	52	<b>T</b>																										
<b>E</b>			Tektronix, Inc.	67	42																								
Electronic Solutions	1	2	Tektronix, Inc.	77	46																								
ELMA Electronics	87	11	Themis Computer	137	71																								
Embedded Systems Conf.	129	69	Themis Computer	58	40																								
Eyring	68	90	Trenton Terminals, Inc.	152	79																								
<b>F</b>			<b>V</b>																										
John Fluke Mfg. Co., Inc.	49	35	VenturCom	44	30																								
Force Computers	40	28	Vigra, Inc.	117	60																								
Franklin Software	146	173	<b>W</b>																										
<b>G</b>			Brian R. White Company	149	76																								
Global Manufacturing Sales Inc.	116	62	Wind River Systems	106	58																								
Grammar Engine	148	185	<b>X</b>																										
Greenspring Computers	39	27	Xycom	36	24																								
Greenspring Computers	37	25	<b>Z</b>																										
Greenspring Computers	41	29	Z-World Engineering	146	172																								
<b>H</b>			Ziatech Corporation	64A	100																								
* Hitachi America, Ltd.	101	54	Zwick Systems, Inc.	148	189																								
Huntsville Microsystems	4	4	<b>Computer Design's INSTANT DATA ACCESS ADVERTISERS</b>																										
<b>I</b>			To receive data sheets instantly from these advertisers via FAX, dial <b>(617) 494-8338</b> and when prompted, enter the 4 digit document number shown here.																										
IBI Systems	147	175	<table border="1"> <thead> <tr> <th>ADVERTISER</th> <th>Page NO.</th> <th>IDA NO</th> </tr> </thead> <tbody> <tr> <td>ATMEL</td> <td>142</td> <td>1050</td> </tr> <tr> <td>Computer Design</td> <td>119</td> <td>1047</td> </tr> <tr> <td>Force</td> <td>40</td> <td>1049</td> </tr> <tr> <td>Hitachi</td> <td>101</td> <td>1034</td> </tr> <tr> <td>Ironics</td> <td>121</td> <td>1046</td> </tr> <tr> <td>KADAK</td> <td>18</td> <td>1036</td> </tr> <tr> <td>SBE</td> <td>CV3</td> <td>1040</td> </tr> </tbody> </table>			ADVERTISER	Page NO.	IDA NO	ATMEL	142	1050	Computer Design	119	1047	Force	40	1049	Hitachi	101	1034	Ironics	121	1046	KADAK	18	1036	SBE	CV3	1040
ADVERTISER	Page NO.	IDA NO																											
ATMEL	142	1050																											
Computer Design	119	1047																											
Force	40	1049																											
Hitachi	101	1034																											
Ironics	121	1046																											
KADAK	18	1036																											
SBE	CV3	1040																											
Imagine That	146	171	<b>* Domestic only</b>																										
Integrated Device Technology	11	6	<b>† International only</b>																										
+ Intel Corporation	151	78	The Advertisers Index is published as a service. The publisher does not assume liability for errors or omissions.																										
Intelligent Systems Int'l	114	63																											
Ironics, Inc.	121	66																											
<b>K</b>																													
KADAK	18	12																											
<b>M</b>																													
Macrolink, Inc.	105	57																											
Matrix Corporation	147	180																											
Matrix Corporation	70	44																											
Mercury Computer Systems	51	36																											
Micro-Sys	147	183																											
Microboards	30	19																											
Micron Technology	31	21																											
Microware Systems	22	16																											
Military & Aerospace Electronics	125	67																											
+ Military & Aerospace Electronics	43	31																											
Mitsubishi Electronics	73	45																											
Mitsubishi Electronics	8-9	5																											
MIZAR	33	22																											
Modular Industrial Solutions	147	176																											
* Motorola Semicond. Products Inc.	43	—																											
Motorola TSD Group	57	39																											



# Access in Europe

## Microelectronics Components Boards Systems

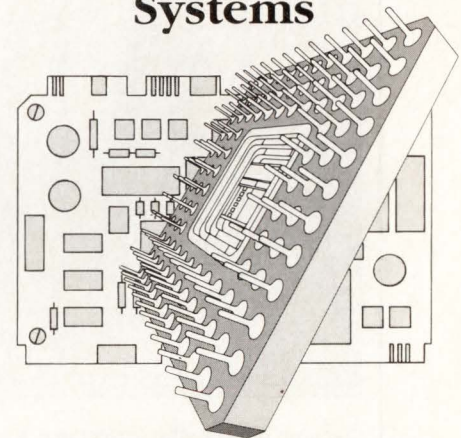

### EUROPEAN SALES OFFICES

#### FINLAND

Intel Finland OY  
Ruusilantie 2  
00390 Helsinki  
Tel.: (358) 0544 644  
Fax: (358) 0544 030  
Telex: 123 332

#### ITALY

Intel Corporation Italia S.p.A.  
Milanofiori Palazzo E  
20090 Assago  
Tel.: (39) (02) 89 20 09 50  
Fax: (39) (02) 349 84 64  
Telex: 341 286

#### FRANCE

Intel Corporation S.A.R.L.  
1, rue Edison - BP 303  
78054 St. Quentin-en-  
Yvelines Cedex  
Tel.: (33) (1) 3057 7000  
Fax: (33) (1) 3064 6032  
Telex: 699 016

#### SPAIN

Intel Iberia S.A.  
Zubaran, 28  
28010 Madrid  
Tel.: (34) 1 308 25 52  
Fax: (34) 1 410 75 70  
Telex: 468 80

#### UNITED KINGDOM

Intel Corporation (U.K.) Ltd.  
Pipers Way  
Swindon Wilts SN3 1RJ  
Tel.: (44) (0793) 69 60 00  
Fax: (44) (0793) 64 14 40  
Telex: 444 447/8

#### SWEDEN

Intel Sweden A.B.  
Dalvagen 24  
17136 Solna  
Tel.: (46) 8 734 01 00  
Fax: (46) 8 27 80 85  
Telex: 122 61

#### NETHERLANDS

Intel Semiconductor B.V.  
Postbus 84130  
3009 CC Rotterdam  
Tel.: (31) 10 407 11 11  
Fax: (31) 10 455 46 88  
Telex: 222 83

#### GERMANY

Intel GmbH  
Dornacher Strasse 1  
8016 Feldkirchen  
Tel.: (49) 089 90 992-0  
Fax: (49) 089 90 439 48  
Telex: 5-23177

#### ISRAEL

Intel Semiconductor Ltd.  
Atidim Industrial Park-  
Neve Sharef  
P. O. Box 43202  
Tel-Aviv 61430  
Tel.: (972) 03 49 80 80  
Fax: (972) 03 49 18 70  
Telex: 371215

Intel GmbH  
Wandersmannstr. 64  
6200 Wiesbaden-Erbenheim  
Fax: (49) 0611 9 77 03 30

Intel GmbH  
Zettachring 10A  
7000 Stuttgart 80  
Tel.: (49) 0711 72 87-280  
Fax: (49) 0711 72 80 137  
Telex: 7-254 826

**CIRCLE NO. 78**

# The Advantage in Single Board Computers

## TRENTON PROCESSORS

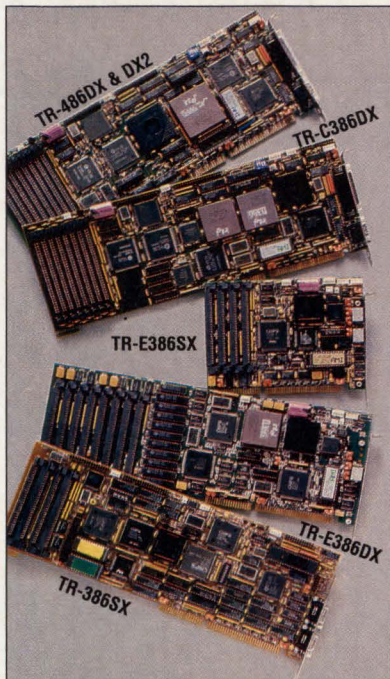

Trenton delivers the perfect match for your Industrial and Instrumentation processor requirements with a wide selection of ISA compatible Single Board Computers. Put an end to compatibility problems and get your product to market on time using a proven Trenton Processor.

Trenton manufactures a complete family of Engine Card and Full Feature processors. Engine Cards feature CPU and memory allowing flexibility in configuring high performance peripherals. Full feature processors add standard PC/AT peripheral ports including serial, parallel, floppy and IDE for a single slot solution.

All Trenton Processors are designed for ease of system integration with features such as added filtering for FCC approval, enhanced bus drive capability for large backplanes, and comprehensive BIOS setup utilities.

**Call TODAY for literature**  
**1-800-875-6031**

FAX 404-381-0048

**Trenton Terminals, Inc.**

3305 Breckinridge Blvd., Suite 100,  
Duluth, GA 30136

*Manufacturing quality products  
in the U.S. for 15 years.*

CIRCLE NO. 79

# COMPUTER DESIGN

*Technology  
and Design  
Directions*

**Executive Office:** One Technology Park Dr, PO Box 990, Westford, MA 01886  
(508) 692-0700 Fax: (508) 692-7780 Telex: 883436

**Publisher:** David L. Allen (508) 392-2111

**Associate Publisher/Editor-in-Chief:** John C. Miklosz (508) 392-2114

**Associate Publisher/National Sales Manager:** Tim L. Tobeck (508) 392-2116

**Administrative Assistant:** Peg Alexander (508) 392-2112

**Marketing Specialist:** Betsy Anderson (508) 392-2209

**Ad Traffic Manager:** Kelly Rice (508) 392-2198

**Recruitment Advertising:** Tom Murphy (213) 372-2744

**Postcards/System Showcase:** Sue Shorrock (508) 392-2185

**Circulation Director:** Bob Dromgoole (918) 832-9213

**Circulation Manager:** Paul Westervelt (918) 832-9287

**List Rental:** Deanna Rebro (918) 831-9551

**Reprints:** June Bozarth (918) 835-3161

## SALES OFFICES

**Associate Publisher**  
Tim L. Tobeck

**National Accounts  
Managers**

**Eastern/Midwestern Region**  
Tim Pritchard  
One Technology Park Dr  
PO Box 990  
Westford, MA 01886  
Tel: (508) 392-2217  
Fax: (508) 692-7780  
Telex: 883436

**Southwestern/  
Northwestern Region**  
Eric Jeter  
19627 I-45 N, Suite 220  
Spring, TX 77388  
Tel: (713) 353-0309  
Fax: (713) 288-8350

**Northern California**  
Diane Palermo  
910 Campisi Way  
Suite 1B  
Campbell, CA, 95008  
Tel: (408) 371-7551  
Fax: (408) 371-6329

**Strategic Accounts  
Representatives**

**Eastern U.S.**  
Sue Nawoichik  
One Technology Park Dr  
PO Box 990  
Westford, MA 01886  
Tel: (508) 392-2118  
Fax: (508) 692-7780

**Western U.S.**  
David Singer  
One Technology Park Dr  
PO Box 990  
Westford, MA 01886  
Tel: (508) 392-2109  
Fax: (508) 692-7780

**U.K./Scandinavia**  
David Round  
Westmead House  
123 Westmead Road  
Sutton  
Surrey SM1 4JH  
Tel: (081) 770-1100  
Fax: (081) 770-9779

**France/Belgium/  
Southern Switzerland/  
Spain/Netherlands**  
Daniel R. Bernard  
10, rue Michelet - B.P. 279  
78502 Sartrouville Cedex, France  
Tel: 01-39-14-67-80  
Fax: 01-39-14-70-14

**Germany/Austria/Northern  
Switzerland/Eastern Europe**

Johann Bylek  
Verlagsbuero Johann Bylek  
Stockaekerring 63  
D-8011 Kirchheim/Muenchen  
Federal Republic of Germany  
Tel: 89-903-88-06  
Fax: 89-904-35-26

**Italy**  
Luigi Rancati  
Rancati Advertising  
Milano San Felice Torre 5  
20090 Segrate, Italy  
Tel: 02-70300088  
Telex: 328601 RANCAD I  
Fax: 02-7532354

**Japan**  
Toshio Egusa  
PubliNetwork  
C407, 2-22-6  
Tsukuda Chuo-ku  
Tokyo 104, Japan  
Tel: 03-3536-5404  
Fax: 03-3536-5490

**Southeast Asia  
Taiwan/Hong Kong/Korea/  
China/Thailand/Philippines/  
India/Pakistan/Singapore/  
Malaysia/Indonesia/Australia/  
New Zealand**  
Tom Gorman  
CCI Asia-Pacific, Ltd  
Suite 905, Guardian House  
32 Oi Kwan Rd, Happy Valley  
Hong Kong  
Tel: 833-2181

COMPUTER DESIGN (ISSN-0010-4566) is published monthly by PennWell Publishing Company, 1421 S Sheridan, Tulsa, OK 74112. Second-class postage paid at Tulsa, OK 74112 and additional mailing offices. Editorial offices are located at One Technology Park Dr, PO Box 990, Westford, MA 01886. Subscription Prices: Free to design and development qualified engineers and engineering managers in the U.S. and Canada. Paid to all others. Qualified engineers and engineering managers outside the U.S. and Canada - air shipped - \$85 one year. For non-qualified recipients in the U.S. - \$88 one year; in all other countries - air shipped - \$154 one year. Call (918) 832-9263 for subscription information. Microfilm copies of COMPUTER DESIGN may be purchased from University Microfilms, a Xerox Company, 300 N Zeeb Rd, Ann Arbor, MI 48106. POSTMASTER: Send change of address form to COMPUTER DESIGN, Circulation Department, PO Box 3466, Tulsa, OK 74101. ©1992 COMPUTER DESIGN by PennWell Publishing Company. All rights reserved. No material may be reprinted without permission from the publisher. Officers of PennWell Publishing Company: Philip C. Lainger, Jr., Chairman and Chief Executive; Joseph A. Wolking, President; John Ford, Senior Vice-President; Carl J. Lawrence, Senior Vice-President; John Maney, Vice-President/Finance; Steve Zimmerman, Vice-President/Corporate Services.



*No Matter  
What the  
Application,  
SBE Fits.*

Matching your high-speed data communications requirements with a quality supplier has never been easier. Whether you're a manufacturer of mini/superminicomputers, workstations or high-performance data communications products, *only* SBE provides a perfect fit.

Only SBE offers a complete line of intelligent high-performance communications controllers for all major interface technologies: FDDI, Token Ring, Ethernet and High Speed Serial. Only SBE adds premium features, without a premium cost, for the best price/performance in the industry.

Add integrated hardware/software solutions; availability in VMEbus, Multibus and SBus; plus legendary development assistance and continuing product support.

Discover how SBE's intelligent high-performance controllers can meet your LAN and WAN interface requirements. Turn to SBE today.

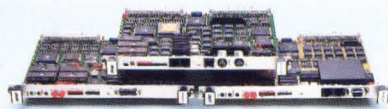

*For fast action, call: 1-800-347-COMM*

Germany: 0130-810588

United Kingdom: 0800-378-234

SBE, Inc., 2400 Bisso Lane, Concord, CA 94520

CIRCLE NO. 80

IDA

INSTANT DATA ACCESS (IDA) DIAL (617) 494-8338 DOCUMENT NO. 1040

**SBE**  
Communications &  
Real-time Solutions

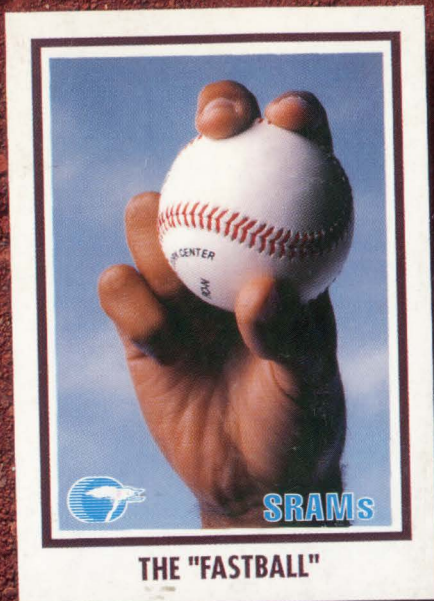

**THE "FASTBALL"**

Scorching access times and a wide range of densities make our SRAMs untouchable. 12 ns 256Ks, 8 ns 64Ks, 4 ns 16Ks and more.

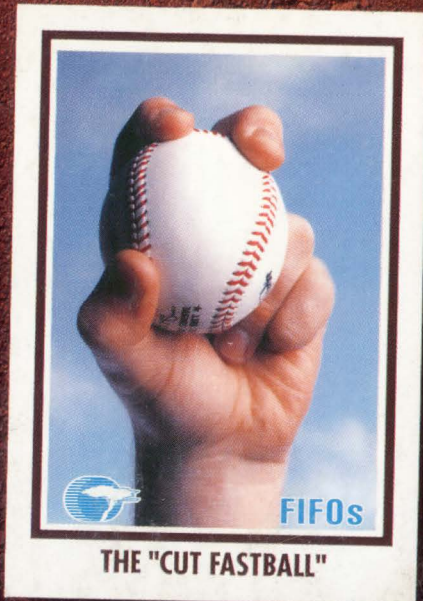

**THE "CUT FASTBALL"**

At 70 MHz, with read/write clocks and synchronous flag features, our FIFOs and Bi-FIFOs move data in and out quickly.

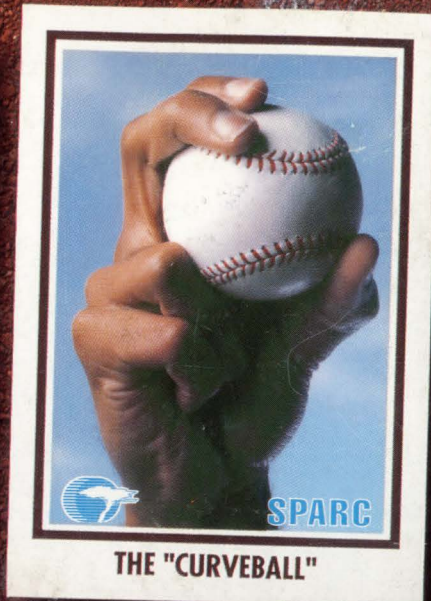

**THE "CURVEBALL"**

Let 'em just try to keep up with the hottest SPARC multiprocessing concept going.

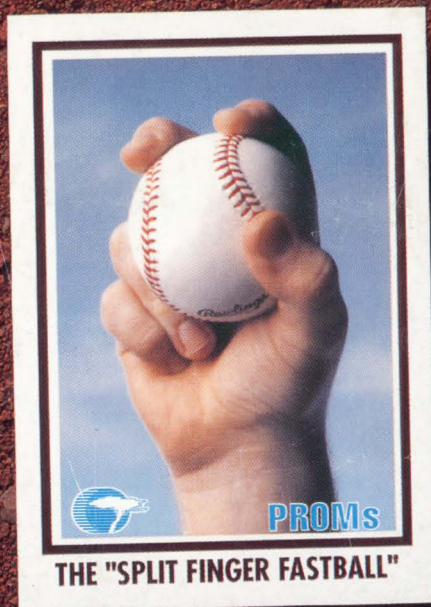

**THE "SPLIT FINGER FASTBALL"**

The fastest access in every PROM density. Broad options make these hard to beat.

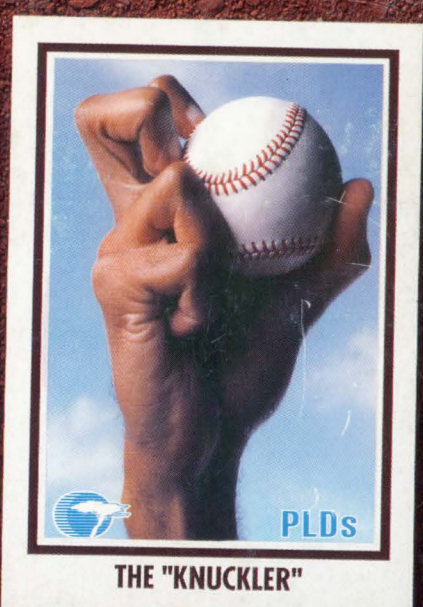

**THE "KNUCKLER"**

PLDs allow crafty designers to mix Gate Array density with 40 MHz performance; even support 125 MHz state machines.

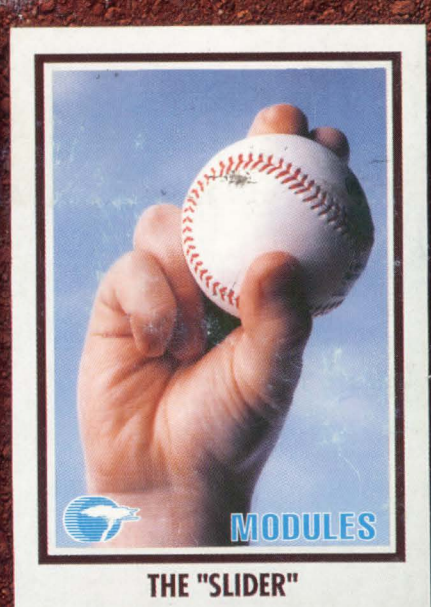

**THE "SLIDER"**

Just when you thought the board was full, multichip modules slip 1 MB SRAMs into a 1/8" space.

# PLAY HARBALL WITH THE COMPETITION.

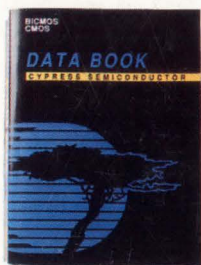

Call today for your free copy of the Cypress 1992 CMOS/BiCMOS Data Book. Get the handbook that's jammed full of the semiconductors you need to create winning product line-ups. Then, smoke the competition.

**FREE 1992 DATA BOOK HOTLINE: 1-800-858-1810\***  
Ask for Dept C114.



\*In Europe, fax your request to the above dept. at (32) 2-652-1504 or call (32) 2-652-0270. In Asia, fax to the above dept. at 1 (415) 961-4201.  
© 1992 Cypress Semiconductor, 3901 North First Street, San Jose CA 95134. Phone 1 (408) 943-2600, TELEX: 821032 CYPRESS SNJ UD TWX: 910-997-0753.