

# LQ10D368

## TFT-LCD Module

(Model No.: LQ10D368)

Spec No.: LD-13305B  
Issue Date: December 6, 2002

---

PREPARED BY :    DATE	<b>SHARP</b>	SPEC No. LD-13305B
APPROVED BY :    DATE		FILE No.
		ISSUE : MAR. 13.2001
		PAGE : 19 pages
	AVC LIQUID CRYSTAL DISPLAY GROUP SHARP CORPORATION	APPLICABLE GROUP AVC LIQUID CRYSTAL DISPLAY GROUP
<b>SPECIFICATION</b>		

REVISION: Dec. 6, 2002

DEVICE SPECIFICATION FOR  
**TFT-LCD Module**  
 MODEL No.  
**LQ10D368**

CUSTOMER'S APPROVAL

DATE \_\_\_\_\_

BY \_\_\_\_\_

PRESENTED

BY *Makoto Takeda*

M. TAKEDA  
 Department General Manager  
 Development Engineering Department II  
 AVC LIQUID CRYSTAL DISPLAY Division  
 AVC LIQUID CRYSTAL DISPLAY GROUP  
 SHARP CORPORATION

RECORDS OF REVISION

LQ10D368

1/4

SPEC NO.	DATE	SUMMARY		NOTE																														
		PAGE																																
LD-13305A	2002.9.25	1	1.Application Added the sentence, “ (This specification is only~)”																															
		2	3.Mechanical Specifications <ul style="list-style-type: none"> <li>Revised mass value 550±20g → 520g(max)</li> <li>Changed the description of unit outline dimensions (D)11.0mm → (D)11.5mm(MAX)</li> <li>Surface treatment : Delete “Haze value=28%”</li> </ul>																															
		3	4.Input terminals <ul style="list-style-type: none"> <li>Changed “Used connector” DF9BA-31P-1V → DF9MA-31P-1V (Corresponding connector is not changed)</li> <li>Changed function of 29,30pin +5.0V power supply → +3.3/5.0V power supply</li> <li>Corrected the description about the connection between shielding case and GND The shielding case is not connected with GND. →The shielding case is connected with GND.</li> </ul>																															
		4	5.Absolute Maximum Ratings Changed storage temp. and operating temp. <ul style="list-style-type: none"> <li>Storage temperature Tstg : -25~+70°C → -30~+70°C</li> <li>Operating temperature(Ambient) Topa : 0~+50°C → -10~+65°C</li> </ul>																															
		5	6.Electrical Characteristics 6-1 TFT-LCDpanel driving <ul style="list-style-type: none"> <li>Changed “Supply voltage” :  <table border="1" style="display: inline-table; margin-right: 20px;"> <tr><th>Min</th><th>Typ</th><th>Max</th></tr> <tr><td>+4.5</td><td>+5.0</td><td>+5.5</td></tr> </table>           →           <table border="1" style="display: inline-table;"> <tr><th>Min</th><th>Typ</th><th>Max</th><th>Unit</th></tr> <tr><td>+3.0</td><td>+3.3</td><td>+5.0</td><td>+5.5</td><td>V</td></tr> </table> </li> <li>Changed “Current dissipation” :  <table border="1" style="display: inline-table; margin-right: 20px;"> <tr><th></th><th>Typ</th><th>Max</th></tr> <tr><td>VCC=5.0V</td><td>280</td><td>450</td></tr> <tr><td>VCC=3.3V</td><td style="text-align: center;">/</td><td style="text-align: center;">/</td></tr> </table>           →           <table border="1" style="display: inline-table;"> <tr><th>Typ</th><th>Max</th><th>Unit</th></tr> <tr><td>150</td><td>230</td><td>mA</td></tr> <tr><td>180</td><td>270</td><td>mA</td></tr> </table> </li> <li>Changed the remark of “Permissive input ripple voltage” : Deleted “Vcc=+5.0V”</li> </ul>		Min	Typ	Max	+4.5	+5.0	+5.5	Min	Typ	Max	Unit	+3.0	+3.3	+5.0	+5.5	V		Typ	Max	VCC=5.0V	280	450	VCC=3.3V	/	/	Typ	Max	Unit	150	230	mA
Min	Typ	Max																																
+4.5	+5.0	+5.5																																
Min	Typ	Max	Unit																															
+3.0	+3.3	+5.0	+5.5	V																														
	Typ	Max																																
VCC=5.0V	280	450																																
VCC=3.3V	/	/																																
Typ	Max	Unit																																
150	230	mA																																
180	270	mA																																

RECORDS OF REVISION

LQ10D368

2/4

SPEC NO.	DATE	PAGE	SUMMARY	NOTE																																										
LD-13305A	2002.9.25	5	<p>• Corrected “Input current” :</p> <table border="1"> <thead> <tr> <th>Parameter</th> <th>Symbol</th> <th>Max</th> <th>Remark</th> </tr> </thead> <tbody> <tr> <td rowspan="2">Input current (Low)</td> <td>I<sub>OL1</sub></td> <td>1.0 μA</td> <td>【Note4】</td> </tr> <tr> <td>I<sub>OL2</sub></td> <td>60.0 μA</td> <td>【Note5】</td> </tr> <tr> <td rowspan="3">Input current (High)</td> <td>I<sub>OH1</sub></td> <td>1.0 μA</td> <td>【Note6】</td> </tr> <tr> <td>I<sub>OH2</sub></td> <td>60.0 μA</td> <td>【Note7】</td> </tr> <tr> <td></td> <td></td> <td></td> </tr> </tbody> </table> <table border="1"> <thead> <tr> <th>Symbol</th> <th>Max</th> <th>Remark</th> </tr> </thead> <tbody> <tr> <td>I<sub>OL1</sub></td> <td>1.0 μA</td> <td>【Note4】</td> </tr> <tr> <td>I<sub>OL2</sub></td> <td>10 μA</td> <td>【Note5】</td> </tr> <tr> <td>I<sub>OL3</sub></td> <td>800 μA</td> <td>【Note6】</td> </tr> <tr> <td>I<sub>OH1</sub></td> <td>1.0 μA</td> <td>【Note7】</td> </tr> <tr> <td>I<sub>OH2</sub></td> <td>300 μA</td> <td>【Note8】</td> </tr> <tr> <td>I<sub>OH3</sub></td> <td>800 μA</td> <td>【Note9】</td> </tr> </tbody> </table> <p>→</p> <p>【Note4】 CK,R0~R5,G0~G5,B0~B5, Hsync,Vsync,ENAB      【Note4】 CK,R0~R5,G0~G5,B0~B5, Hsync,Vsync</p> <p>【Note5】 R/L      → 【Note5】 U/D,ENAB</p> <p>【Note6】 CK, R0~R5,G0~G5,B0~B5, Hsync,Vsync      【Note6】 R/L</p> <p>【Note7】 ENAB,U/D      【Note7】 CK,R0~R5,G0~G5,B0~B5, Hsync,Vsync,R/L</p> <p>【Note8】 ENAB</p> <p>【Note9】 U/D</p> <p>• 【Note1】 Changed “Vcc-turm-on conditions”</p> <p> <math>T1 \leq 15ms</math>      <math>0 &lt; T1 \leq 15ms</math>  <math>0 &lt; T2 \leq 10ms</math>      → <math>0 &lt; T2 \leq 10ms</math>  <math>0 &lt; T3 \leq 20ms</math>      <math>0 &lt; T3 \leq 100ms</math>  <math>0 &lt; T4 \leq 1s</math>      <math>0 &lt; T4 \leq 1s</math>  <math>1s &lt; T5</math>      <math>T5 &gt; 200ms</math> </p> <p>• 【Note1】 Changed “Vcc-dip condition”</p> <p><math>2.7V \leq Vcc &lt; 4.5V</math> <math>td \leq 10ms</math></p> <p>→ <math>2.5V \leq Vcc</math> <math>td \leq 10ms</math></p> <p>• 【Note2】 Changed the typical current situation</p> <p><math>VCC=+5.0V</math> → <math>VCC=+3.3V/5.0V</math></p> <p>• 【Note2】 Corrected the figure of typical current situation</p>	Parameter	Symbol	Max	Remark	Input current (Low)	I <sub>OL1</sub>	1.0 μA	【Note4】	I <sub>OL2</sub>	60.0 μA	【Note5】	Input current (High)	I <sub>OH1</sub>	1.0 μA	【Note6】	I <sub>OH2</sub>	60.0 μA	【Note7】				Symbol	Max	Remark	I <sub>OL1</sub>	1.0 μA	【Note4】	I <sub>OL2</sub>	10 μA	【Note5】	I <sub>OL3</sub>	800 μA	【Note6】	I <sub>OH1</sub>	1.0 μA	【Note7】	I <sub>OH2</sub>	300 μA	【Note8】	I <sub>OH3</sub>	800 μA	【Note9】	
		Parameter	Symbol	Max	Remark																																									
Input current (Low)	I <sub>OL1</sub>	1.0 μA	【Note4】																																											
	I <sub>OL2</sub>	60.0 μA	【Note5】																																											
Input current (High)	I <sub>OH1</sub>	1.0 μA	【Note6】																																											
	I <sub>OH2</sub>	60.0 μA	【Note7】																																											
Symbol	Max	Remark																																												
I <sub>OL1</sub>	1.0 μA	【Note4】																																												
I <sub>OL2</sub>	10 μA	【Note5】																																												
I <sub>OL3</sub>	800 μA	【Note6】																																												
I <sub>OH1</sub>	1.0 μA	【Note7】																																												
I <sub>OH2</sub>	300 μA	【Note8】																																												
I <sub>OH3</sub>	800 μA	【Note9】																																												
		6	<p>6-2 Backlight driving</p> <p>• According with the change of operating temperature spec, added “Kick off voltage” value at Ta= -10°C :</p> <p>Kick off voltage : Max 1500Vrms(Ta= -10°C)</p> <p>• Changed “Lamp life time” : Typ 50000 h → Min 50000h</p>																																											

## RECORDS OF REVISION

LQ10D368

3/4

SPEC NO.	DATE	SUMMARY		NOTE
		PAGE		
LD-13305A	2002.9.25	6	<ul style="list-style-type: none"> <li>• 【Note2】 Corrected the condition At the condition of <math>Y_L=200\text{cd/m}^2</math> →At the condition of <math>I_L=6.0\text{mA}</math></li> </ul>	
		7	7 Timing Characteristics of input signals Corrected “Timing characteristics” <ul style="list-style-type: none"> <li>• Vertical sync. signal Cycle TV(Mode:400line) : Min 445 → 446line</li> </ul>	
		13	9. Optical Characteristics <ul style="list-style-type: none"> <li>• Changed the condition of “Viewing Angle Range” (Widening viewing angle range) <math>CR \geq 5 \rightarrow CR &gt; 10</math></li> <li>• Changed the measurement condition               <ul style="list-style-type: none"> <li>① Changed the remark of chromaticity and luminance Added “<math>I_L=6.0\text{mA}</math>, <math>f=35\text{KHz}</math>”</li> <li>② ※(typical condition : <math>I_L=6.0\text{mA}</math>)→(condition : <math>I_L=6.0\text{mA}</math>)</li> </ul> </li> </ul>	
		15	11. Handling Precautions Changed “Handling precautions” <ul style="list-style-type: none"> <li>• h)① Laminated film~ → Protection film~</li> <li>② Deleted “Ionized air shall~”</li> <li>• Added “j”</li> <li>• Added “m”</li> <li>• Added “n”</li> </ul> 12. Packing form Corrected packing form <ul style="list-style-type: none"> <li>• Piling number of cartons : 7cartons → 8cartons</li> <li>• Carton size : 298(W)×362(D)×295(h) →497(W)×318(D)×227(h)</li> <li>• Total mass of one carton filled with full modules : 8.0kg → 7.8kg</li> <li>• Packing form is shown : Fig.7 → Fig.4</li> </ul>	

RECORDS OF REVISION

LQ10D368

4/4

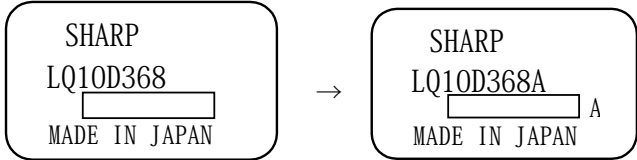
SPEC NO.	DATE	SUMMARY		NOTE
		PAGE		
LD-13305A	2002.9.25	16	<p>13.Reliability test items</p> <p>According with the change of the temperature spec, test condition was changed.</p> <ul style="list-style-type: none"> <li>• Low temperatue storage test Ta=-25°C 240h → Ta=-30°C 240h</li> <li>• High temperature operation test Ta= 50°C 240h → Ta= 65°C 240h</li> <li>• Low temperature operation test Ta= 0°C 240h → Ta=-10°C 240h</li> </ul>	
			<p>14.Others</p> <ul style="list-style-type: none"> <li>• 1.Label                             <ul style="list-style-type: none"> <li>① Changed the figure of module label</li> </ul> </li> </ul>  <p>According with the change of driver IC,the letter “A” at the end of the lot number was added.</p> <ul style="list-style-type: none"> <li>②Added the figure of packing box label</li> </ul>	
		17	Changed procedure to backlight replacement	
		18	<p>Packing Form</p> <ul style="list-style-type: none"> <li>• Corerected Packing Form</li> <li>• Changed Fig.No : Fig.7 → Fig.4</li> </ul>	
		19	<p>Outline dimensions</p> <ul style="list-style-type: none"> <li>• In accordance with the change of mechanical components, outline-dimension figure was changed</li> <li>• Added detail figure of input connector part (DETAIL K)</li> </ul>	
LD-13305B	2002.12.6	19	<p>Outline Dimensions</p> <ul style="list-style-type: none"> <li>• Corrected the dimension between connector and plastic chassis</li> <li>• Added HEIGHT OF PARTS ON PRINTED WIRING BOARD</li> <li>• Added HEIGHT OF I/F PRINTED WIRING BOARD</li> </ul>	

## 1. Application

This specification applies to color TFT-LCD module, LQ10D368  
(This specification is only applied for the module which has letter "A" at the end of the lot number of the module.)

These specification sheets are the proprietary product of SHARP CORPORATION("SHARP") and include materials protected under copyright of SHARP. Do not reproduce or cause any third party to reproduce them in any form or by any means, electronic or mechanical, for any purpose, in whole or in part, without the express written permission of SHARP .

The device listed in these specification sheets was designed and manufactured for use in general electronic equipment.

In case of using the device for applications such as control and safety equipment for transportation(aircraft, trains, automobiles, etc. ), rescue and security equipment and various safety related equipment which require higher reliability and safety, take into consideration that appropriate measures such as fail-safe functions and redundant system design should be taken .

Do not use the device for equipment that requires an extreme level of reliability, such as aerospace applications, telecommunication equipment(trunk lines), nuclear power control equipment and medical or other equipment for life support .

SHARP assumes no responsibility for any damage resulting from the use of the device which does not comply with the instructions and the precautions specified in these specification sheets .

Contact and consult with a SHARP sales representative for any questions about this device .

## 2. Overview

This module is a color active matrix LCD module incorporating amorphous silicon TFT (Thin Film Transistor). It is composed of a color TFT-LCD panel, driver ICs, control circuit and power supply circuit and a backlight unit. Graphics and texts can be displayed on a  $640 \times 3 \times 480$  dots panel with 262,144 colors by supplying 18 bit data signal (6bit/color), four timing signals,+3.3V/ +5V DC supply voltage for TFT-LCD panel driving and supply voltage for backlight.

The TFT-LCD panel used for this module is a low-reflection and higher-color-saturation type. Therefore, this module is also suitable for the multimedia use.

Optimum viewing direction is 6 o'clock.

Backlight-driving DC/AC inverter is not built in this module.

## 3. Mechanical Specifications

Parameter	Specifications	Unit
Display size	26 (10.4") Diagonal	cm
Active area	211.2(H) × 158.4(V)	mm
Pixel format	640(H) × 480(V)	pixel
	(1 pixel = R + G + B dots)	
Pixel pitch	0.330(H) × 0.330(V)	mm
Pixel configuration	R,G,B vertical stripe	
Display mode	Normally white	
Unit outline dimensions *1	246.5(W) × 179.4(H) × 11.0max(D)	mm
Mass	520(max)	g
Surface treatment	Anti-glare and hard-coating 3H	

\*1.Note: excluding backlight cables.

Outline dimensions is shown in Fig.1



## 4. Input Terminals

## 4-1. TFT-LCD panel driving

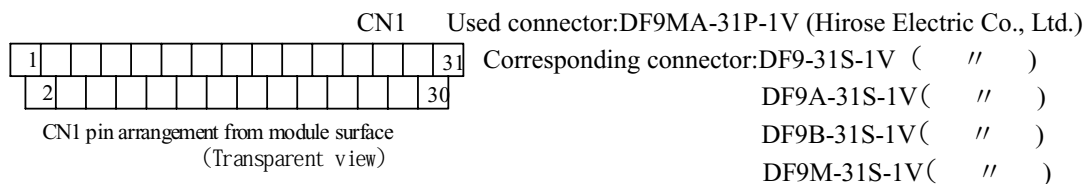

Pin No.	Symbol	Function	Remark
1	GND		
2	CK	Clock signal for sampling each data signal	
3	Hsync	Horizontal synchronous signal	【Note1】
4	Vsync	Vertical synchronous signal	【Note1】
5	GND		
6	R0	R E D data signal(LSB)	
7	R1	R E D data signal	
8	R2	R E D data signal	
9	R3	R E D data signal	
10	R4	R E D data signal	
11	R5	R E D data signal(MSB)	
12	GND		
13	G0	G R E E N data signal(LSB)	
14	G1	G R E E N data signal	
15	G2	G R E E N data signal	
16	G3	G R E E N data signal	
17	G4	G R E E N data signal	
18	G5	G R E E N data signal(MSB)	
19	GND		
20	B0	B L U E data signal(LSB)	
21	B1	B L U E data signal	
22	B2	B L U E data signal	
23	B3	B L U E data signal	
24	B4	B L U E data signal	
25	B5	B L U E data signal(MSB)	
26	GND		
27	ENAB	Signal to settle the horizontal display position	【Note2】
28	Vcc	+3.3/5.0V power supply	
29	Vcc	+3.3/5.0V power supply	
30	R/L	Horizontal display mode select signal	【Note3】
31	U/D	Vertical display mode select signal	【Note4】

※The shielding case is connected with GND.

【Note1】 480 line, 400 line or 350 line mode  
 is selected by the polarity combination  
 of the both synchronous signals.

Mode	480 lines	400 lines	350 lines
Hsync	Negative	Negative	Positive
Vsync	Negative	Positive	Negative

【Note2】 The horizontal display start timing is settled in accordance with a rising timing of ENAB signal. In case ENAB is fixed "Low", the horizontal start timing is determined as described in 7-2. Don't keep ENAB "High" during operation.

【Note3】 【Note4】

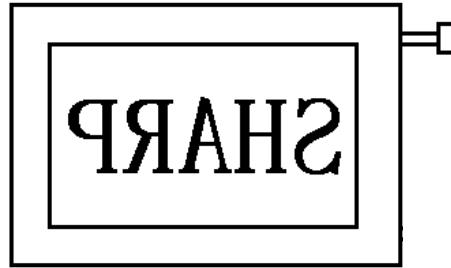
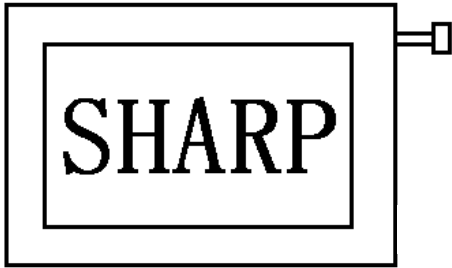

R/L=High、U/D=Low

R/L=Low、U/D=Low

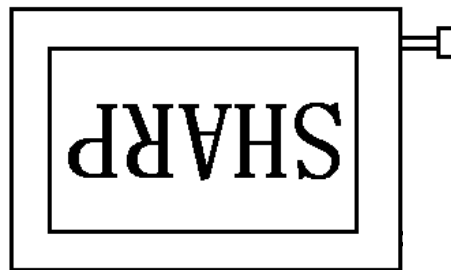

R/L=High、U/D=High

R/L=Low、U/D=High

#### 4-2. Backlight driving

Used connector : BHR-03VS-1(JST)

CN2

Corresponding connector :SM02(8.0)B-BHS(JST)

Pin no.	Symbol	Function
1	V <sub>HIGH</sub>	Power supply for lamp (High voltage side)
2	NC	This is electrically opened.
3	V <sub>LOW</sub>	Power supply for lamp (Low voltage side)

#### 5. Absolute Maximum Ratings

Parameter	Symbol	Condition	Ratings	Unit	Remark
Input voltage	V <sub>I</sub>	Ta=25°C	-0.3 ~ V <sub>CC</sub> +0.3	V	【Note1】
+5V supply voltage	V <sub>CC</sub>	Ta=25°C	0 ~ +6	V	
Storage temperature	T <sub>stg</sub>	—	-30 ~ +70	°C	【Note2】
Operating temperature (Ambient)	Topa	—	-10 ~ +65	°C	

【Note1】 CK,R0~R5,G0~G5,B0~B5,Hsync,Vsync,ENAB, R/L, U/L

【Note2】 Humidity : 95%RH Max. at Ta≤40°C.

Maximum wet-bulb temperature at 39°C or less at Ta>40°C.

No condensation.

## 6. Electrical Characteristics

### 6-1. TFT-LCD panel driving

Ta=25°C

Parameter		Symbol	Min.	Typ.	Max.	Unit	Remark
Power Supply	Supply voltage	V <sub>CC</sub>	+3.0	+3.3   +5.0	+5.5	V	【Note1】
	Current dissipation	I <sub>CC</sub>	—	180	270	m A	V <sub>CC</sub> =3.3V 【Note2】
		I <sub>CC</sub>	—	150	230	m A	V <sub>CC</sub> =5.0V 【Note2】
Permissive input ripple voltage		V <sub>RF</sub>	—	—	100	mVp-p	
Input voltage (Low)		V <sub>IL</sub>	—	—	0.3V <sub>CC</sub>	V	【Note3】
Input voltage (High)		V <sub>IH</sub>	0.7V <sub>CC</sub>	—	—	V	
Input current (low)		I <sub>OL1</sub>	—	—	1.0	μ A	V <sub>I</sub> =0V 【Note4】
		I <sub>OL2</sub>	—	—	10	μ A	V <sub>I</sub> =0V 【Note5】
		I <sub>OL3</sub>	—	—	800	μ A	V <sub>I</sub> =0V 【Note6】
Input current (High)		I <sub>OH1</sub>	—	—	1.0	μ A	V <sub>I</sub> =V <sub>CC</sub> 【Note7】
		I <sub>OH2</sub>	—	—	300	μ A	V <sub>I</sub> =V <sub>CC</sub> 【Note8】
		I <sub>OH3</sub>	—	—	800	μ A	V <sub>I</sub> =V <sub>CC</sub> 【Note9】

#### 【 NOTE1】

V<sub>CC</sub>-turn-on conditions

- 0 < T<sub>1</sub> ≤ 15 m s
- 0 < T<sub>2</sub> ≤ 10 m s
- 0 < T<sub>3</sub> ≤ 100 m s
- 0 < T<sub>4</sub> ≤ 1 s
- T<sub>5</sub> > 200 m s

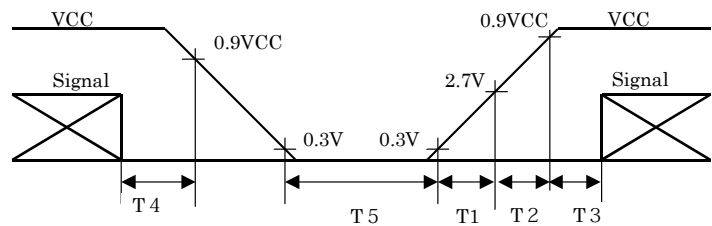

V<sub>CC</sub>-dip conditions

- 1) 2.5 V ≤ V<sub>CC</sub>
- T<sub>d</sub> ≤ 10 m s

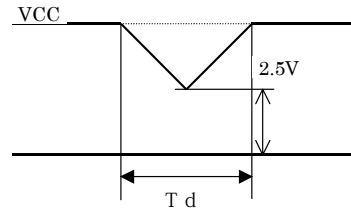

- 2) V<sub>CC</sub> < 2.5 V

V<sub>CC</sub>-dip condition should also follow  
The V<sub>CC</sub>-turn-on conditions

【Note2】 Typical current situation : 16-gray-bar pattern.

480 line mode/V<sub>CC</sub>=+3.3V/+5.0V

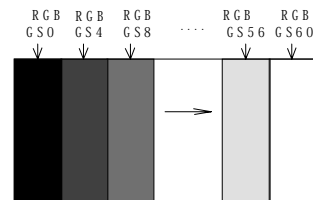

【Note3】 CK,R0~R5,G0~G5,B0~B5,Hsync,Vsync,ENAB,  
R/L,U/D

【Note4】 CK,R0~R5,G0~G5,B0~B5,Hsync,Vsync,

【Note5】 U/D,ENAB

【Note6】 R/L

【Note7】 CK,R0~R5,G0~G5,B0~B5,Hsync,Vsync,R/L

【Note8】 ENAB

【Note9】 U/D

## 6-2. Backlight driving

The backlight system is an edge-lighting type with single CCFT (Cold Cathode Fluorescent Tube). The characteristics of lamp are shown in the following table.

Ta=25°C

Parameter	Symbol	Min.	Typ.	Max.	Unit	Remark
Lamp current	I <sub>L</sub>	2.0	6.0	6.5	mArms	【Note1】
Lamp power consumption	P <sub>L</sub>	—	3.0	—	W	【Note2】
Lamp frequency	F <sub>L</sub>	20	35	60	KHz	【Note3】
Kick-off voltage	V <sub>s</sub>	—	—	950	Vrms	Ta=25°C 【Note4】
		—	—	1400	Vrms	Ta =0°C 【Note4】
		—	—	1500	Vrms	Ta =-10°C 【Note4】
Lamp life time	L <sub>L</sub>	50000	—	—	hour	【Note5】

【Note1】 Lamp current is measured with current meter for high frequency as shown below.

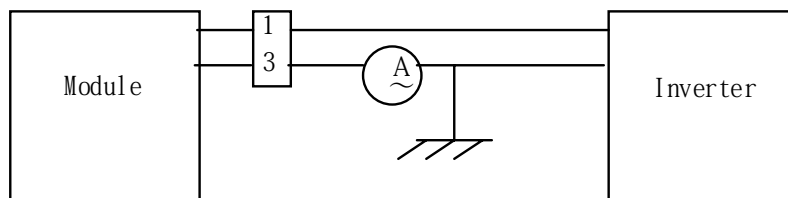

\* 3pin is V<sub>LOW</sub>

【Note2】 At the condition of I<sub>L</sub>=6.0mArms

【Note3】 Lamp frequency may produce interference with horizontal synchronous frequency, and this may cause beat on the display. Therefore lamp frequency shall be detached as much as possible from the horizontal synchronous frequency and from the harmonics of horizontal synchronous to avoid interference.

【Note4】 The open output voltage of the inverter shall be maintained for more than 1sec; otherwise the lamp may not be turned on.

【Note5】 Since lamp is consumables, the life time written above is referencial value and it is not guaranteed in this specification sheet by SHARP.

Lamp life time is defined that it applied either ① or ② under this condition  
(Continuous turning on at Ta=25°C, IL=6.0mArms)

① Brightness becomes 50% of the original value under standard condition.

② Kick-off voltage at Ta=-10°C exceeds maximum value, 1500Vrms.

In case of operating under lower temp environment, the lamp exhaustion is accelerated and the brightness becomes lower.

(Continuous operating under for around 1 month under lower temp condition may reduce the brightness to half of the original brightness.)

In case of such usage under lower temp environment, periodical lamp exchange is recommended.

【Note6】 The performance of the backlight, for example life time or brightness, is much influenced by the characteristics of the DC-AC inverter for the lamp. When you design or order the inverter, please make sure that a poor lighting caused by the mismatch of the backlight and the inverter (miss-lighting, flicker, etc.) never occur. when you confirm it, the module should be operated in the same condition as it is installed in your instrument.

## 7. Timing Characteristics of input signals

Timing diagrams of input signal are shown in Fig.2 - ①~③ .

### 7-1. Timing characteristics

Parameter		Symbol	Mode	Min.	Typ.	Max.	Unit	Remark
Clock	Frequency	1/Tc	all	—	25.18	28.33	MHz	
	High time	Tch	//	5	—	—	ns	
	Low time	Tcl	//	10	—	—	ns	
Data	Setup time	Tds	//	5	—	—	ns	
	Hold time	Tdh	//	10	—	—	ns	
Horizontal sync. signal	Cycle	TH	//	30.00	31.78	—	$\mu s$	
			//	750	800	900	clock	
	Pulse width	THp	//	2	96	200	clock	
Vertical sync. signal	Cycle	TV	480	515	525	560	line	
			400	446	449	480	line	
			350	447	449	510	line	
	Pulsewidth	TVp	all	1	—	34	line	
Horizontal display period		THd	//	640	640	640	clock	
Hsync-Clock phase difference		THc	//	10	—	Tc-10	ns	
Hsync-Vsync phase difference		TVh	//	0	—	TH-THp	clock	

Note) In case of lower frequency, the deterioration of display quality, flicker etc., may be occurred.

### 7-2. Horizontal display position

The horizontal display position is determined by ENAB signal and the input data corresponding to the rising edge of ENAB signal is displayed at the left end of the active area.

Parameter		symbol	Min.	Typ.	Max.	Unit	Remark
Enable signal	Setup time	Tes	5	—	Tc-10	ns	
	Pulse width	Tep	2	640	640	clock	
Hsync-Enable signal phase difference		THE	44	—	TH-664	clock	

Note) When ENAB is fixed "Low", the display starts from the data of C104(clock) as shown

in Fig.2-①~③. Be careful that the module does not work when ENAB is fixed "High".

When the phase difference is below 104 clock, keep the "High level of ENAB is signal longer Than 104-The. If it will not be kept, the display starts from the data of C104(clock).

### 7-3. Vertical display position

The vertical display position is automatically centered in the active area at each mode of VGA ,480-,400-,and 350-line mode . Each mode is selected depending on the polarity of the synchronous signals described in 4-1(Note1).

In each mode ,the data of TVn is displayed at the top line of the active area. And the display position will be centered on the screen like the following figure when the period of vertical synchronous signal,TV,is typical value.

In 400-,and 350-line mode,the data in the vertical data invalid period is also displayed, So ,inputting all data "0" is recommended during vertical data invalid period.

ENAB signal has no relation to the vertical display position.

Mode	V-data start(TVs)	V-data period(TVd)	V-display start(TVn)	V-display period	Unit	Remark
480	34	480	34	480	line	
400	34	400	443-TV	480	line	
350	61	350	445-TV	480	line	

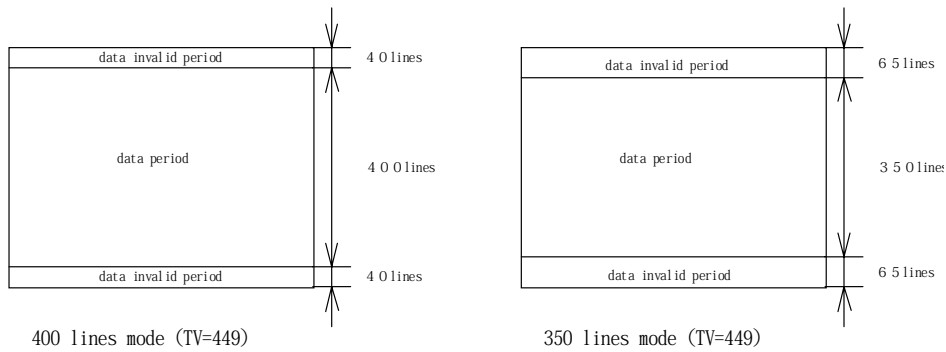

### 7-4. Input Data Signals and Display Position on the screen

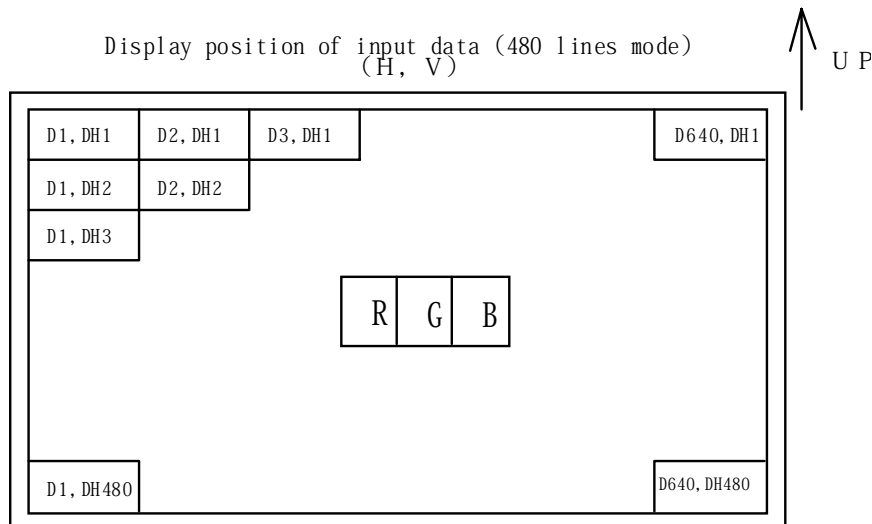

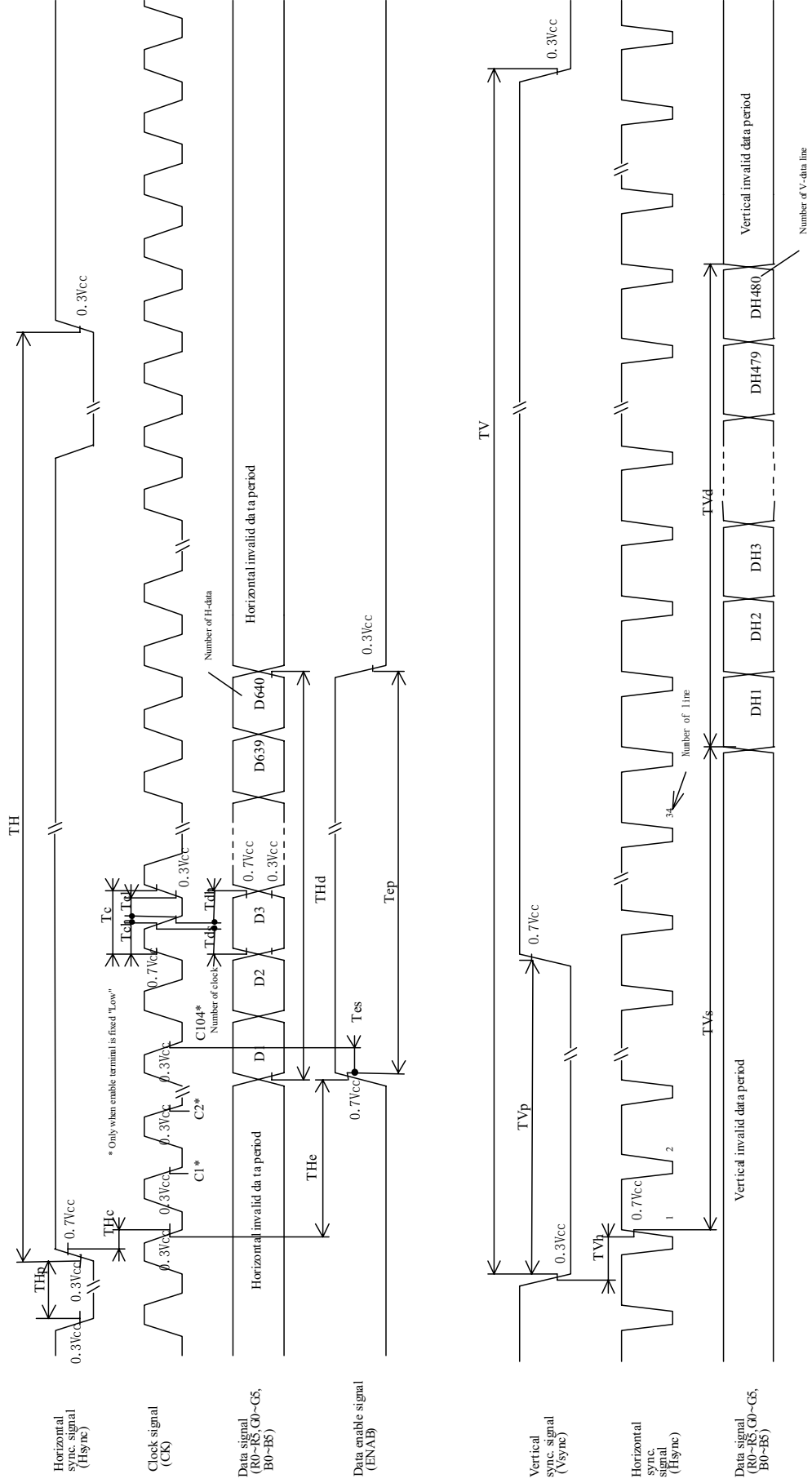

Fig 2-1 Input signal waveforms (480 line mode)

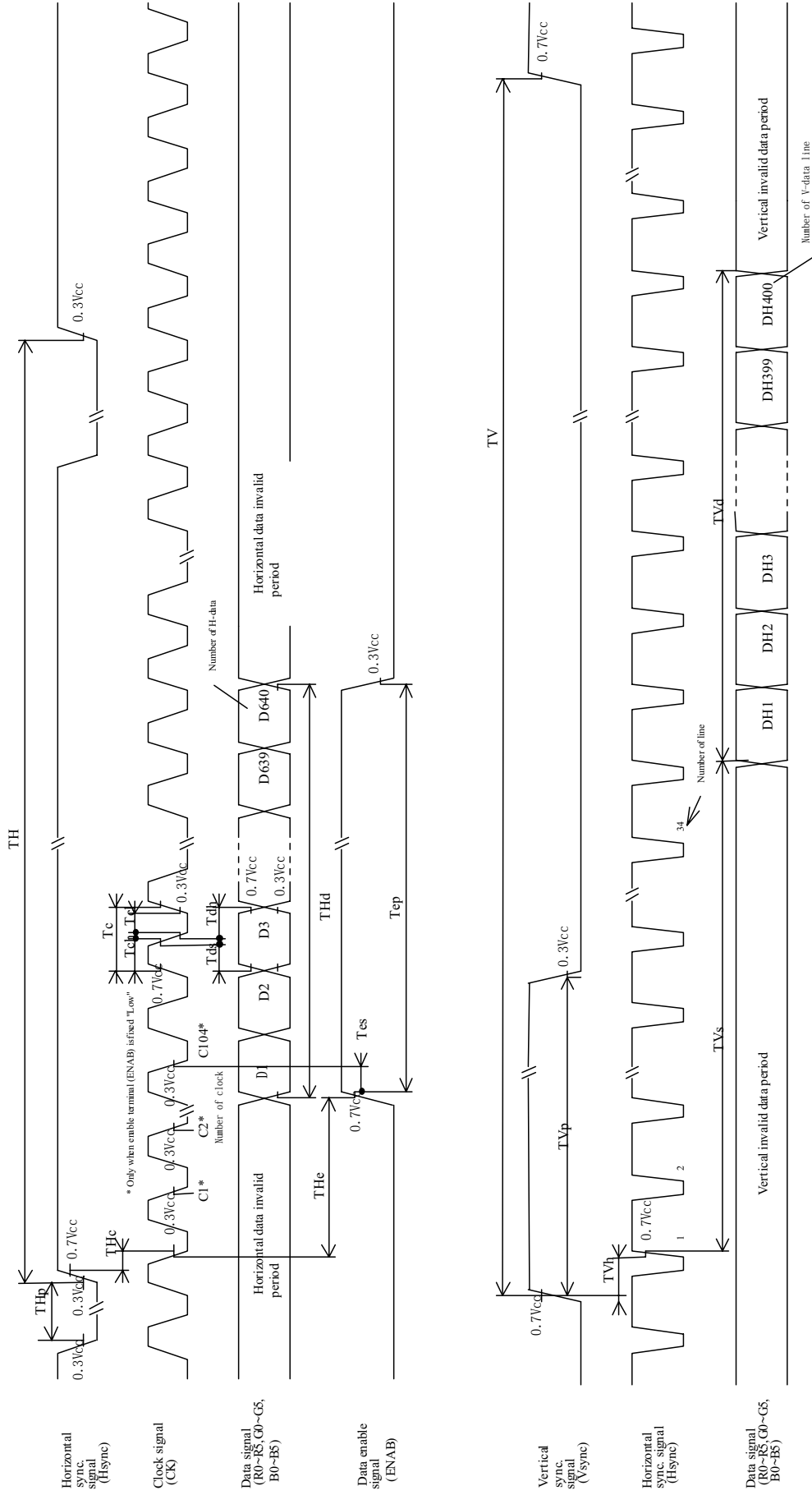

Fig.2-2 Input signal waveforms (400 line mode)



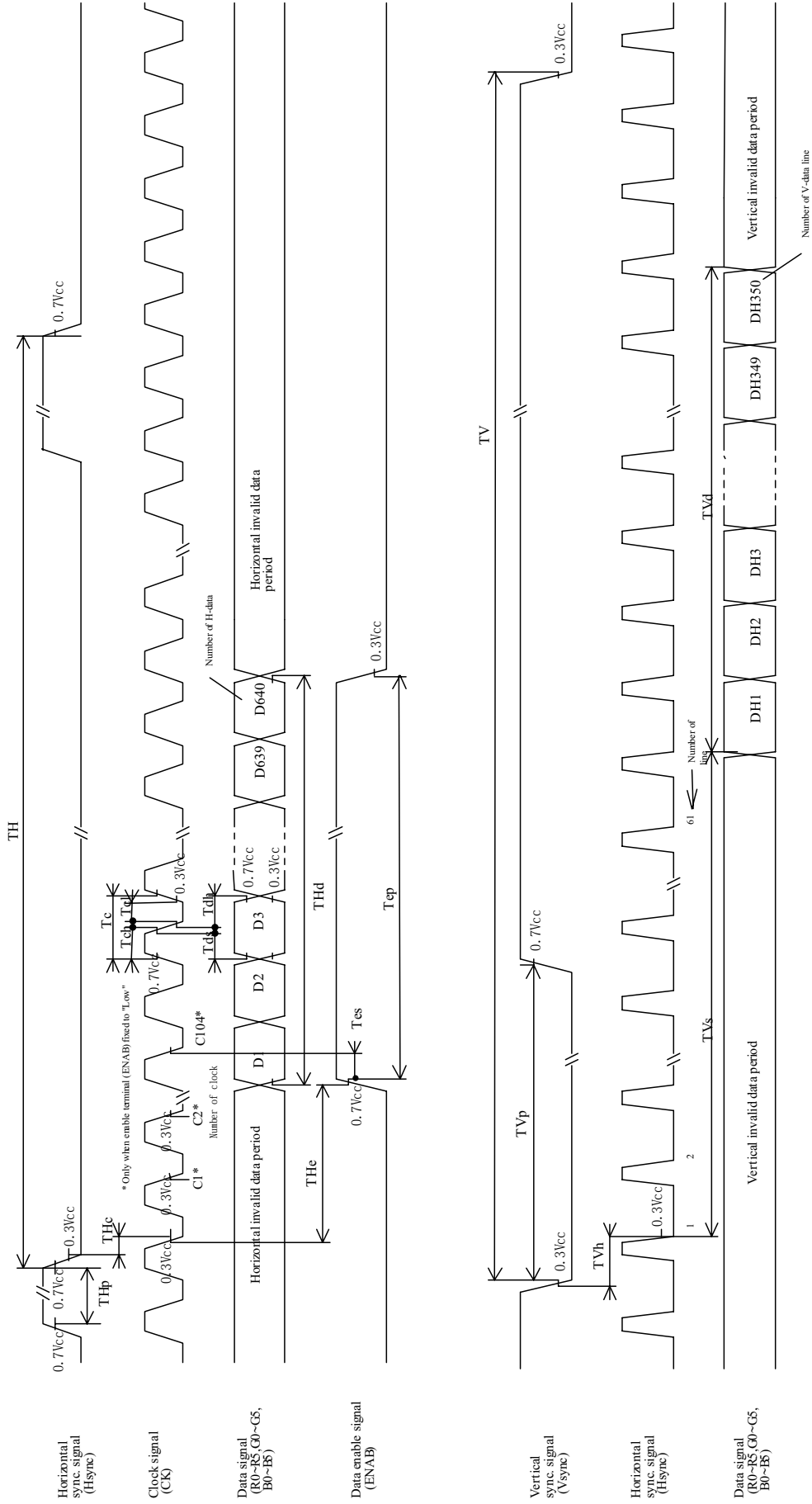

Fig.2-3 Input signal waveforms (350 line mode)

## 8. Input Signals, Basic Display Colors and Gray Scale of Each Color

	Colors & Gray scale	Data signal																		
		Gray Scale	R0	R1	R2	R3	R4	R5	G0	G1	G2	G3	G4	G5	B0	B1	B2	B3	B4	B5
Basic Color	Black	—	0	0	0	0	0	0	0	0	0	0	0	0	0	0	0	0	0	0
	Blue	—	0	0	0	0	0	0	0	0	0	0	0	0	1	1	1	1	1	1
	Green	—	0	0	0	0	0	0	1	1	1	1	1	1	0	0	0	0	0	0
	Cyan	—	0	0	0	0	0	0	1	1	1	1	1	1	1	1	1	1	1	1
	Red	—	1	1	1	1	1	1	0	0	0	0	0	0	0	0	0	0	0	0
	Magenta	—	1	1	1	1	1	1	0	0	0	0	0	0	1	1	1	1	1	1
	Yellow	—	1	1	1	1	1	1	1	1	1	1	1	1	0	0	0	0	0	0
	White	—	1	1	1	1	1	1	1	1	1	1	1	1	1	1	1	1	1	1
Gray Scale of Red	Black	GS0	0	0	0	0	0	0	0	0	0	0	0	0	0	0	0	0	0	0
	↑	GS1	1	0	0	0	0	0	0	0	0	0	0	0	0	0	0	0	0	0
	Darker	GS2	0	1	0	0	0	0	0	0	0	0	0	0	0	0	0	0	0	0
	↑	↓				↓					↓						↓			
	↓	↓				↓					↓						↓			
	Brighter	GS61	1	0	1	1	1	1	0	0	0	0	0	0	0	0	0	0	0	0
	↓	GS62	0	1	1	1	1	1	0	0	0	0	0	0	0	0	0	0	0	0
	Red	GS63	1	1	1	1	1	1	0	0	0	0	0	0	0	0	0	0	0	0
Gray Scale of Green	Black	GS0	0	0	0	0	0	0	0	0	0	0	0	0	0	0	0	0	0	0
	↑	GS1	0	0	0	0	0	0	1	0	0	0	0	0	0	0	0	0	0	0
	Darker	GS2	0	0	0	0	0	0	0	1	0	0	0	0	0	0	0	0	0	0
	↑	↓				↓					↓						↓			
	↓	↓				↓					↓						↓			
	Brighter	GS61	0	0	0	0	0	0	1	0	1	1	1	1	0	0	0	0	0	0
	↓	GS62	0	0	0	0	0	0	0	1	1	1	1	1	0	0	0	0	0	0
	Green	GS63	0	0	0	0	0	0	1	1	1	1	1	1	0	0	0	0	0	0
Gray Scale of Blue	Black	GS0	0	0	0	0	0	0	0	0	0	0	0	0	0	0	0	0	0	0
	↑	GS1	0	0	0	0	0	0	0	0	0	0	0	0	1	0	0	0	0	0
	Darker	GS2	0	0	0	0	0	0	0	0	0	0	0	0	0	1	0	0	0	0
	↑	↓				↓					↓						↓			
	↓	↓				↓					↓						↓			
	Brighter	GS61	0	0	0	0	0	0	0	0	0	0	0	0	1	0	1	1	1	1
	↓	GS62	0	0	0	0	0	0	0	0	0	0	0	0	0	1	1	1	1	1
	Blue	GS63	0	0	0	0	0	0	0	0	0	0	0	0	1	1	1	1	1	1

0 : Low level voltage, 1 : High level voltage

Each basic color can be displayed in 64 gray scales from 6 bit data signals. According to the combination of total 18 bit data signals, the 262,144-color display can be achieved on the screen.

## 9. Optical Characteristics

 $T_a=25^{\circ}\text{C}$ ,  $V_{cc}=+5\text{V}$ 

Parameter		Symbol	Condition	Min	Typ	Max	Unit	Remark
Viewing Angle Range	Horizontal	$\theta_{21}, \theta_{22}$	$C R > 1.0$	60	70	—	Deg.	【Note1,4】
	Vertical	$\theta_{11}$		35	40	—	Deg.	
		$\theta_{12}$		55	70	—	Deg.	
Contrast ratio		C R	$\theta = 0^{\circ}$	150	—	—	—	【Note2,4】
			Optimum Viewing Angle	—	300	—	—	
Response Time	Rise	$\tau_r$	$\theta = 0^{\circ}$	—	20	—	ms	【Note3,4】
	Decay	$\tau_d$		—	40	—	ms	
Chromaticity of White		x		—	0.313	—		【Note4】
		y		—	0.329	—		
Luminance of white		$Y_L$		160	200	—	$\text{cd/m}^2$	$I_L=6.0\text{mA rms}$ $f=35\text{kHz}$
White Uniformity		$\delta_w$		—	—	1.45	—	【Note5】
Viewing Angle range as a Brightness Definition	Horizontal	$\theta_{21}, \theta_{22}$		50% of the maximum brightness	—	45	—	Deg.
			Vertical		$\theta_{11}$	—	35	—
	$\theta_{12}$	—			30	—	Deg.	

※The measurement shall be executed 30 minutes after lighting at rating. (condition: $I_L=6.0\text{mA rms}$ )

The optical characteristics shall be measured in a dark room or equivalent state with the method shown in Fig.3 below.

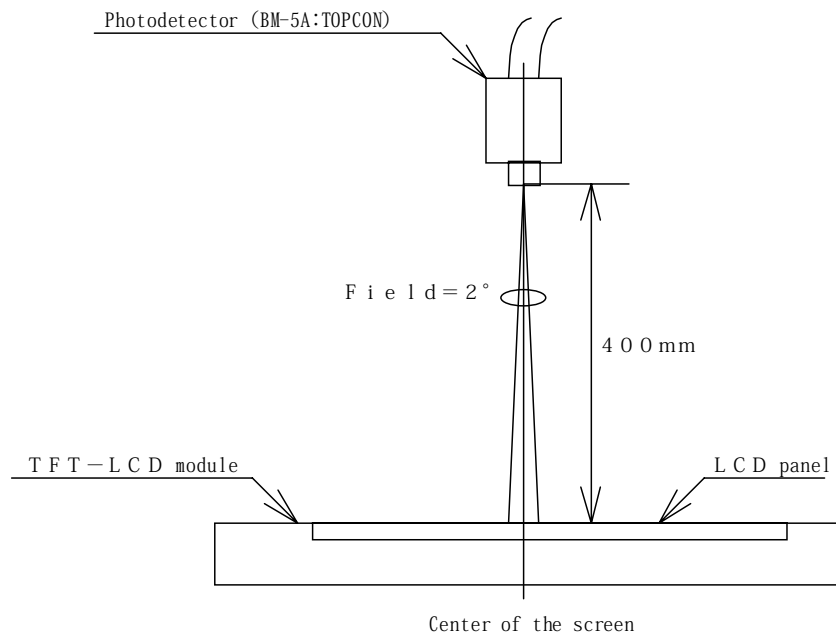
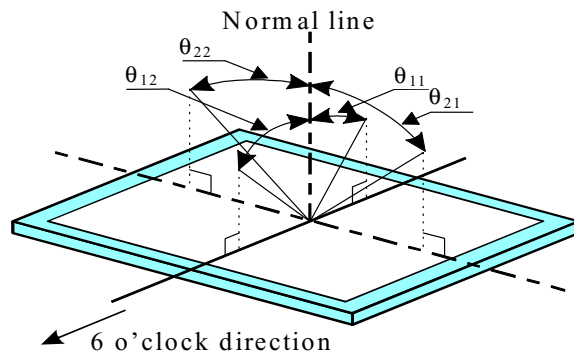

Fig.3 Optical characteristics measurement method

【Note1】 Definitions of viewing angle range:



【Note2】 Definition of contrast ratio:

The contrast ratio is defined as the following.

$$\text{Contrast Ratio (CR)} = \frac{\text{Luminance (brightness) with all pixels white}}{\text{Luminance (brightness) with all pixels black}}$$

【Note3】 Definition of response time:

The response time is defined as the following figure and shall be measured by switching the input signal for "black" and "white" .

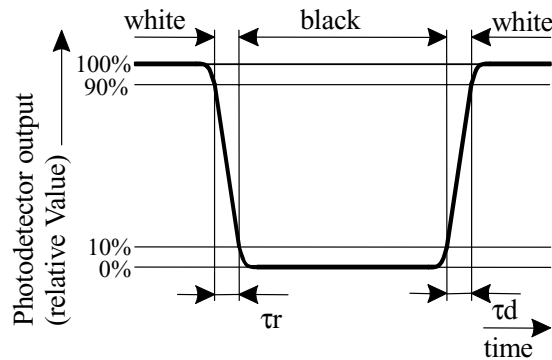

【Note4】 This shall be measured at center of the screen.

【Note5】 Definition of white uniformity:

White uniformity is defined as the following with five measurements (A~E).

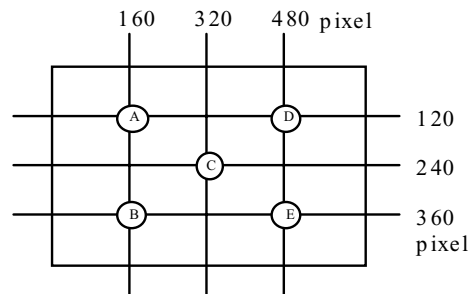

$$\delta_w = \frac{\text{Maximum Luminance of five points (brightness)}}{\text{Minimum Luminance of five points (brightness)}}$$

10. Display Quality

The display quality of the color TFT-LCD module shall be in compliance with the Incoming Inspection Standard.

11. Handling Precautions

- a) Be sure to turn off the power supply when inserting or disconnecting the cable.
- b) Be sure to design the cabinet so that the module can be installed without any extra stress such as warp or twist.
- c) Since the front polarizer is easily damaged, pay attention not to scratch it.
- d) Wipe off water drop immediately. Long contact with water may cause discoloration or spots.
- e) When the panel surface is soiled, wipe it with absorbent cotton or other soft cloth.
- f) Since the panel is made of glass, it may break or crack if dropped or bumped on hard surface.  
Handle with care.
- g) Since CMOS LSI is used in this module, take care of static electricity and injure the human earth when handling. Observe all other precautionary requirements in handling electric components.
- h) Protection film is attached to the module surface to prevent it from being scratched .  
Peel the film off slowly , just before the use, with strict attention to electrostatic charges.  
Blow off 'dust' on the polarizer by using an ionized nitrogen.
- i) The polarizer surface on the panel is treated with Anti-Glare for low reflection. In case of attaching protective board over the LCD, be careful about the optical interface fringe etc. which degrades display quality.
- j) Do not expose the LCD panel to direct sunlight. Lightproof shade etc. should be attached when LCD panel is used under such environment.
- k) Connect GND to 4 place of mounting holes to stabilize against EMI and external noise.
- l) There are high voltage portions on the backlight and very dangerous. Careless touch may lead to electrical shock. When exchange lamps or service, turn off the power without fail.
- m) When handling LCD modules and assembling them into cabinets, please be noted that long-term storage in the environment of oxidization or deoxidization gas and the use of such materials as reagent, solvent, adhesive, resin, etc. which generate these gasses, may cause corrosion and discoloration of the LCD modules.
- n) Cold cathode fluorescent lamp in LCD panel contains a small amount of mercury, please follow local ordinances or regulations for disposal.
- o) Be sure not to apply tensile stress to the lamp lead cable.

12. Packing form

Product country	JAPAN
Piling number of cartons	8 (Max)
Packing quantity in one carton	10
Carton size [mm]	497(W)×318(D)×227(H)
Total mass of one carton filled with full modules	7.8 kg
Packing form is shown	Fig.4

### 13. Reliability test items

No.	Test item	Conditions
1	High temperature storage test	Ta=70°C 240h
2	Low temperature storage test	Ta= -30°C 240h
3	High temperature & high humidity operation test	Ta=40°C ; 95%RH 240h (No condensation)
4	High temperature operation test	Ta=65°C 240h
5	Low temperature operation test	Ta= -10°C 240h
6	Vibration test (non- operating)	Frequency: 10~57Hz/Vibration width (one side):0.075mm : 58~500Hz/Gravity:9.8m/s <sup>2</sup> Sweep time : 11 minutes Test period : 3 hours (1 hour for each direction of X,Y,Z)
7	Shock test (non- operating)	Max. gravity : 490m/s <sup>2</sup> Pulse width : 11ms, half sine wave Direction : ±X,±Y,±Z once for each direction.

#### 【Result Evaluation Criteria】

Under the display quality test conditions with normal operation state, these shall be no change which may affect practical display function.

### 14. Others

#### 1) Label:

Module

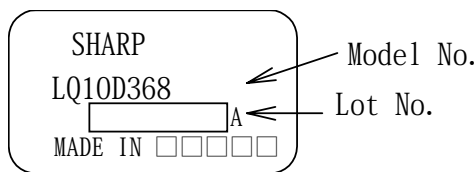

Packing box

①Model No.②ShipmentDate ③ Quantity

社内品番 : (4 S) LQ10D368 ①
<input type="text"/> ①
Lot NO. : (1 T) 2002. 9. 1 ②
<input type="text"/> ②
Quantity : (Q) 20 pcs ③
<input type="text"/> ③
ユーザ品番 :
シャープ物流用ラベルです。

2) Adjusting volume have been set optimally before shipment, so do not change any adjusted value.

If adjusted value is changed, the specification may not be satisfied.

3) Disassembling the module can cause permanent damage and should be strictly avoided.

4) Please be careful since image retention may occur when a fixed pattern is displayed for a long time

5) If any problem occurs in relation to the description of this specification , it shall be resolved through discussion with spirit of cooperation.

## Procedure to backlight replacement

Lamp which is used in the LCD module is consumable goods. When the lamp replacement is needed due to the expiry of lamp-operating life, replace the lamp with lamp holder following with below procedure 1) to 4).

Make sure that the power supply of DC/AC inverter which operates the lamp is turned off before the lamp replacement. Also, please wear fingerstall and be careful not to put any stain or scratch on the LCD panel.

## Replacement procedure

- (1) Put the module rear side on the top.
- (2) Slide the edge (shaded area) of the lamp unit to the direction which arrow X indicates.  
(The hook of the lamp unit will be unhooked from the hook b of the module.)
- (3) Slide the lamp unit to the direction which arrow Y indicates, holding the edge of the lamp unit slid to the direction which arrow X indicates.
- (4) Insert new lamp unit into the LCD module and install the lamp unit until the hook a and b is engaged.

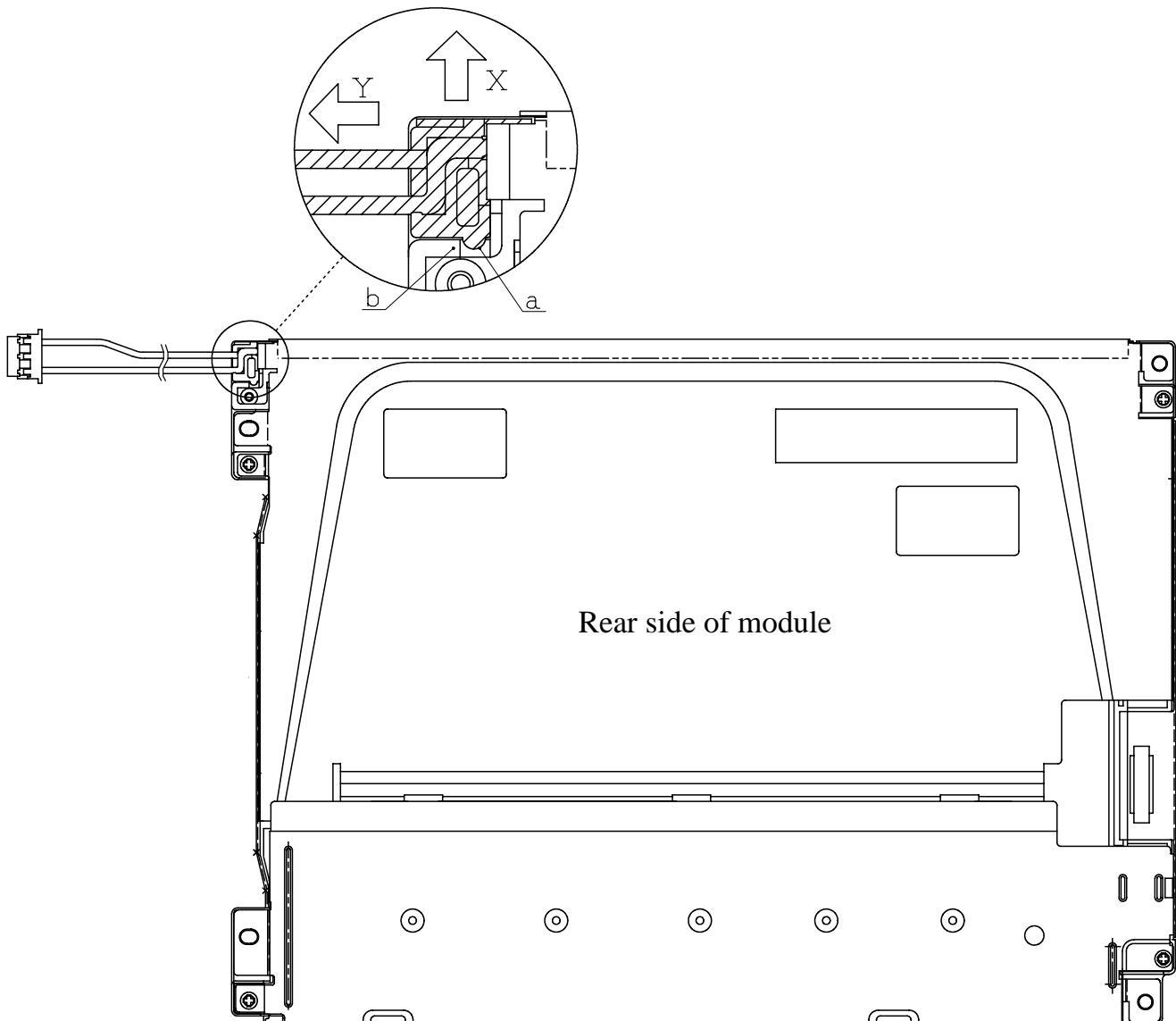

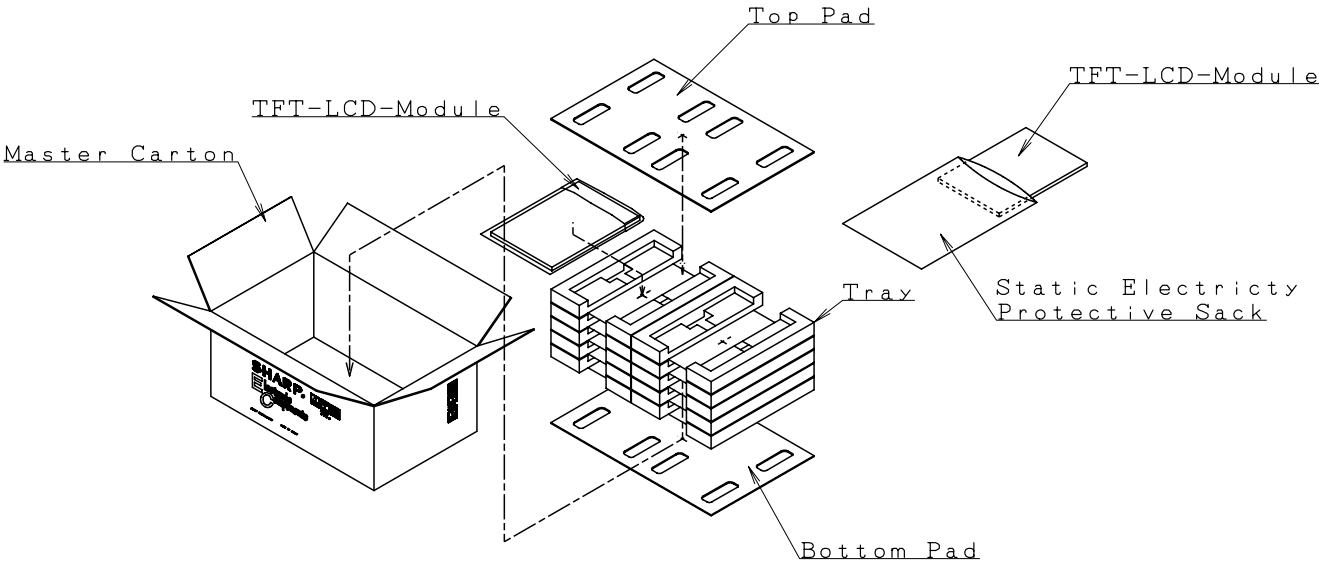

Fig.4 Packing Form



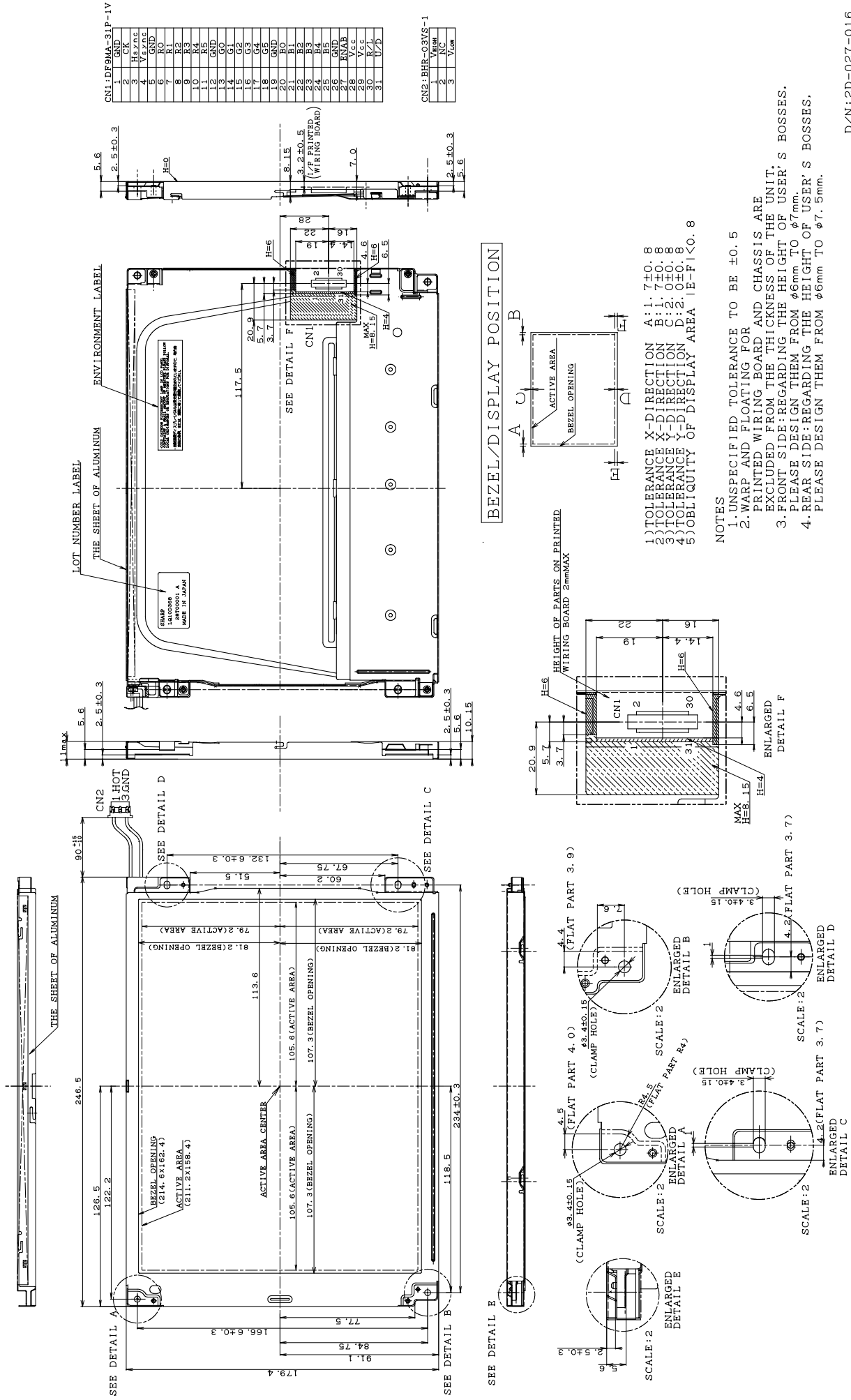

Fig.1 LQ10D368 Outline Dimensions

**SPECIFICATIONS ARE SUBJECT TO CHANGE WITHOUT NOTICE.**

Suggested applications (if any) are for standard use; See Important Restrictions for limitations on special applications. See Limited Warranty for SHARP's product warranty. The Limited Warranty is in lieu, and exclusive of, all other warranties, express or implied. ALL EXPRESS AND IMPLIED WARRANTIES, INCLUDING THE WARRANTIES OF MERCHANTABILITY, FITNESS FOR USE AND FITNESS FOR A PARTICULAR PURPOSE, ARE SPECIFICALLY EXCLUDED. In no event will SHARP be liable, or in any way responsible, for any incidental or consequential economic or property damage.

---

# SHARP®

## **NORTH AMERICA**

---

SHARP Microelectronics of the Americas  
5700 NW Pacific Rim Blvd.  
Camas, WA 98607, U.S.A.  
Phone: (1) 360-834-2500  
Fax: (1) 360-834-8903  
Fast Info: (1) 800-833-9437  
www.sharpsma.com

## **EUROPE**

---

SHARP Microelectronics Europe  
Division of Sharp Electronics (Europe) GmbH  
Sonninstrasse 3  
20097 Hamburg, Germany  
Phone: (49) 40-2376-2286  
Fax: (49) 40-2376-2232  
www.sharpsme.com

## **JAPAN**

---

SHARP Corporation  
Electronic Components & Devices  
22-22 Nagaike-cho, Abeno-Ku  
Osaka 545-8522, Japan  
Phone: (81) 6-6621-1221  
Fax: (81) 6117-725300/6117-725301  
www.sharp-world.com

## **TAIWAN**

---

SHARP Electronic Components  
(Taiwan) Corporation  
8F-A, No. 16, Sec. 4, Nanking E. Rd.  
Taipei, Taiwan, Republic of China  
Phone: (886) 2-2577-7341  
Fax: (886) 2-2577-7326/2-2577-7328

## **SINGAPORE**

---

SHARP Electronics (Singapore) PTE., Ltd.  
438A, Alexandra Road, #05-01/02  
Alexandra Technopark,  
Singapore 119967  
Phone: (65) 271-3566  
Fax: (65) 271-3855

## **KOREA**

---

SHARP Electronic Components  
(Korea) Corporation  
RM 501 Geosung B/D, 541  
Dohwa-dong, Mapo-ku  
Seoul 121-701, Korea  
Phone: (82) 2-711-5813 ~ 8  
Fax: (82) 2-711-5819

## **CHINA**

---

SHARP Microelectronics of China  
(Shanghai) Co., Ltd.  
28 Xin Jin Qiao Road King Tower 16F  
Pudong Shanghai, 201206 P.R. China  
Phone: (86) 21-5854-7710/21-5834-6056  
Fax: (86) 21-5854-4340/21-5834-6057

### **Head Office:**

No. 360, Bashen Road,  
Xin Development Bldg. 22  
Waigaoqiao Free Trade Zone Shanghai  
200131 P.R. China  
Email: smc@china.global.sharp.co.jp

## **HONG KONG**

---

SHARP-ROXY (Hong Kong) Ltd.  
3rd Business Division,  
17/F, Admiralty Centre, Tower 1  
18 Harcourt Road, Hong Kong  
Phone: (852) 28229311  
Fax: (852) 28660779  
www.sharp.com.hk

### **Shenzhen Representative Office:**

Room 13B1, Tower C,  
Electronics Science & Technology Building  
Shen Nan Zhong Road  
Shenzhen, P.R. China  
Phone: (86) 755-3273731  
Fax: (86) 755-3273735