



PREPARED BY : DATE	 DISPLAY DEVICE BUSINESS DIVISION SHARP CORPORATION SPECIFICATION	SPEC No. LD-25707A
APPROVED BY : DATE		FILE No. LD-25707A
		ISSUE : 10-Jul-13
		PAGE : 29pages
		APPLICABLE GROUP DISPLAY DEVICE BUSINESS DIVISION

REVISION :

DEVICE SPECIFICATION FOR
TFT-LCD Module
 MODEL No.
LQ043T1DG29

These parts have corresponded with the RoHS directive.

CUSTOMER'S APPROVAL
 BY _____

BY 
 T.OHNISHI
 DEPARTMENT GENERAL MANAGER
 DEVELOPMENT DEPARTMENT III
 DISPLAY DEVICE UNIT III
 DISPLAY DEVICE BUSINESS DIVISION
 SHARP CORPORATION

NOTICE

This specification is the proprietary of SHARP and is copyrighted, with all rights reserved. Under the copyright laws, no part of this specification may be reproduced or transmitted in any form or by any means, electronic or mechanical for any purpose, in whole or in part, without the express written permission of SHARP. Express written permission is also required before any use of this specification may be made by a third party.

The application circuit examples in this specification are provided to explain the representative applications of SHARP's devices and are not intended to guarantee any circuit design or permit any industrial property right or other rights to be executed. SHARP takes no responsibility for any problems related to any industrial property right or a third party resulting from the use of SHARP's devices, except for those resulting directly from device manufacturing processes.

In case of using the device for application such as control and safety equipment for transportation (controls of aircraft, trains, automobiles, etc), rescue and security equipment and various safety related equipment which require higher reliability and safety, take into consideration that appropriate measures such as fail-safe function and redundant system design should be taken.

Do not use the device for equipment that requires an extreme level of reliability, such as aerospace applications, telecommunication equipment (trunk lines), nuclear power control equipment and medical or other equipment for life support.

SHARP assumes no responsibility for any damage resulting from the use of the device which does not comply with the instructions and the precautions specified in this specification.

Contact and consult with a SHARP representative for any questions about this device.

1. Applicable Scope

This specification is applicable to TFT-LCD Module “LQ043T1DG29”.

2. General Description

This module is a color active matrix LCD module incorporating amorphous silicon TFT (Thin Film Transistor).

It is composed of a color TFT-LCD panel, driver IC , Input FPC, a back light unit.

Graphics and texts can be displayed on a 480 x 272 x RGB dots panel with about 262k colors by supplying 18bit data signals (6bit x RGB), four timing signals, 3wires 24bit serial interface signals, logic (Typ. +3.3V), analog (Typ. +3.3V) supply voltages for TFT-LCD panel driving and supply voltage for back light.

3. Mechanical (Physical) Specifications

Item	Specifications	Unit
Screen size	10.9 (4.3" type) diagonal	cm
Active area	95.04 (H) × 53.856 (V)	mm
Pixel format	480 (H) x 272 (V)	pixel
	1Pixel =R+G+B dots	-
Pixel pitch	0.198 (H) x 0.198 (V)	mm
Pixel configuration	R,G,B horizontal stripes	-
Display mode	Normally white	-
Unit outline dimensions	105.5 (W) x 67.2 (H) x 3.1 (D)	mm
Mass	About 36	g
Surface hardness	2H	-
Surface treatment	Anti glare	-

※The above-mentioned table indicates module sizes without some projections and FPC.

For detailed measurements and tolerances, please refer to 18. Outline Dimensions.

4. Input Terminal Names and Functions

Recommendation CN : [HIROSE] FH26G-67S-0.3SHBW(05) or [KYOCERA ELCO] 00 6281 067 2X2 829 +

Pin No	Symbol	I/O	Description	Remarks
1	LED_C (-)	-	Power supply for LED (Cathode)	
2	LED_A(+)	-	Power supply for LED (Anode)	
3	DGND1	-	Digital Ground	
4	NC	-	No connection	
5	NC	-	No connection	
6	NC	-	No connection	
7	NC	-	No connection	
8	AGND1	-	Analog Ground	
9	VGH	-	Connect a Stabilizing capacitor to GND	Note 4-1
10	C11P	-	Connect a Booster capacitor to C11M	Note 4-1
11	C11M	-	Connect a Booster capacitor to C11P	Note 4-1
12	C12P	-	Connect a Booster capacitor to C12M	Note 4-1
13	C12M	-	Connect a Booster capacitor to C12P	Note 4-1
14	VGL	-	Connect a Stabilizing capacitor to GND	Note 4-1
15	C13P	-	Connect a Booster capacitor to C13M	Note 4-1
16	C13M	-	Connect a Booster capacitor to C13P	Note 4-1
17	AGND2	-	Analog Ground	
18	DDVDH	-	Connect a Stabilizing capacitor to GND	Note 4-1
19	C14P	-	Connect a Booster capacitor to C14M	Note 4-1
20	C14M	-	Connect a Booster capacitor to C14P	Note 4-1
21	VCC	-	Booster input voltage pin	
22	NC	-	No connection	
23	AGND3	-	Analog Ground	
24	VCL2	-	Connect a Stabilizing capacitor to GND	Note 4-1
25	C21P	-	Connect a Booster capacitor to C21M	Note 4-1
26	C21M	-	Connect a Booster capacitor to C21P	Note 4-1
27	IOVCC	-	Voltage input pin for logic I/O	Note 4-1
28	RESB	I	System reset	
29	DGND2	-	Digital Ground	
30	IOVCC	-	Voltage input pin for logic I/O	
31	VDD	-	Connect a Stabilizing capacitor to GND	Note 4-1
32	DGND3	-	Digital Ground	
33	SHUT	I	Sleep mode control	
34	CSB	I	Chip select pin of serial interface	
35	SDI	I	Data input pin in serial mode	
36	SCK	I	Clock input pin in serial mode	
37	AGND4	-	Analog Ground	Note 4-1
38	DEN	I	Display enable signal	
39	B5	I	BLUE data signal(MSB)	
40	B4	I	BLUE data signal	
41	B3	I	BLUE data signal	

Pin No.	Symbol	I/O	Description	Remarks
42	B2	I	BLUE data signal	
43	B1	I	BLUE data signal	
44	B0	I	BLUE data signal(LSB)	
45	G5	I	GREEN data signal(MSB)	
46	G4	I	GREEN data signal	
47	G3	I	GREEN data signal	
48	G2	I	GREEN data signal	
49	G1	I	GREEN data signal	
50	G0	I	GREEN data signal(LSB)	
51	R5	I	RED data signal(MSB)	
52	R4	I	RED data signal	
53	R3	I	RED data signal	
54	R2	I	RED data signal	
55	R1	I	RED data signal	
56	R0	I	RED data signal(LSB)	
57	VSYNC	I	Frame synchronization signal	
58	HSYNC	I	Line synchronization signal	
59	DOTCLK	I	Dot-clock signal	
60	VC11	-	Connect a Stabilizing capacitor to GND	Note 4-1
61	DGND4	-	Digital Ground	
62	VREG	-	Connect a Stabilizing capacitor to GND	Note 4-1
63	VCOMH	-	Connect a Stabilizing capacitor to GND	Note 4-1
64	VCOML	-	Connect a Stabilizing capacitor to GND	Note 4-1
65	DGND5	-	Digital Ground	
66	C22P	-	Connect a Booster capacitor to C22M	Note 4-1
67	C22M	-	Connect a Booster capacitor to C22P	Note 4-1

[Note 4-1] Recommended Capacitors and Diodes

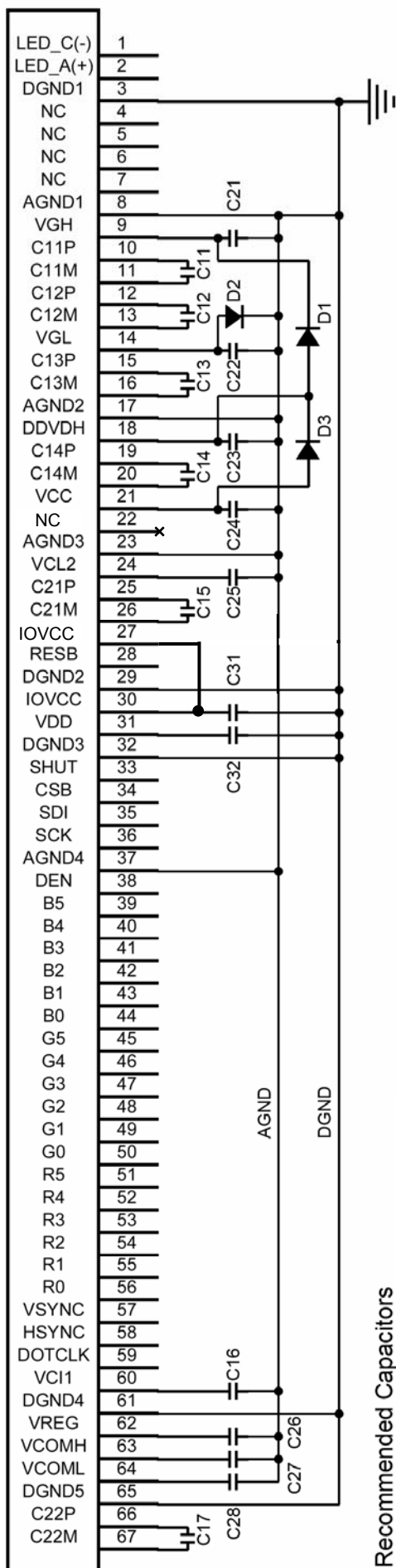

Recommended Capacitors

Ref No.	Capacitance	Rated Voltage	Temperature Characteristic
C11	1 µF	6.3 V	B(JIS) or X5R(EIA)
C12	1 µF	6.3 V	B(JIS) or X5R(EIA)
C13	1 µF	6.3 V	B(JIS) or X5R(EIA)
C14	1 µF	6.3 V	B(JIS) or X5R(EIA)
C15	1 µF	10 V	B(JIS) or X5R(EIA)
C16	2.2 µF	6.3 V	B(JIS) or X5R(EIA)
C17	1 µF	10 V	B(JIS) or X5R(EIA)
C21	2.2 µF	25 V	B(JIS) or X5R(EIA)
C22	2.2 µF	25 V	B(JIS) or X5R(EIA)
C23	4.7 µF	10 V	B(JIS) or X5R(EIA)
C24	2.2 µF	6.3 V	B(JIS) or X5R(EIA)
C25	4.7 µF	6.3 V	B(JIS) or X5R(EIA)
C26	4.7 µF	10 V	B(JIS) or X5R(EIA)
C27	4.7 µF	10 V	B(JIS) or X5R(EIA)
C28	4.7 µF	6.3 V	B(JIS) or X5R(EIA)
C31	2.2 µF	6.3 V	B(JIS) or X5R(EIA)
C32	2.2 µF	6.3 V	B(JIS) or X5R(EIA)
D1	Schottky diode VF < 0.38V/5mA@25°C, VR ≥ 25V		
D2	Schottky diode VF < 0.38V/5mA@25°C, VR ≥ 25V		
D3	Schottky diode VF < 0.38V/5mA@25°C, VR ≥ 25V		

[Note]
 C11P/M, C12P/M, C13P/M, C14P/M, C21P/M, C22P/M are high voltage switching lines on FPC.
 Surround/shield by AGND to avoid noise coupling to other pins.
 Also aware the PCB design to avoid other components to be affected by noise on those dc/dc pins.

5. Absolute Maximum Ratings

Item	Symbol	Conditions	Rated value	Unit	Remarks
Input voltage	VI	Ta = 25°C	-0.3 ~ IOVCC+0.3	V	Note 5-1
Logic I/O power supply voltage	IOVCC	Ta = 25°C	-0.3 ~ +4.0	V	
Analog power supply voltage	VCC	Ta = 25°C	AGND-0.3 ~ +4.6	V	
Temperature for storage	Tstg	-	-30~ +85	°C	Note 5-2
Temperature for operation	Topr	-	-10 ~ +70	°C	Note 5-2, 5-3
LED input electric current	I _{LED}	Ta = 25°C	35	mA	Note 5-4
LED electricity consumption	P _{LED}	Ta = 25°C	123	mW	Note 5-4

[Note 5-1] RESB, SHUT, CSB, SDI, SCK, DEN, B5~B0, G5~G0, R5~R0, VSYNC, HSYNC, DOTCLK

[Note 5-2] Humidity: 95%RH Max. (Ta ≤ 40°C)

Maximum bulb temperature under 39°C (Ta > 40°C) See to it that no dew will be condensed.

[Note 5-3] The high temperature is the panel surface temperature regulations.

[Note 5-4] Power consumption of one LED (Ta = 25°C).

Ambient temperature and the maximum input are fulfilling the following operating conditions.

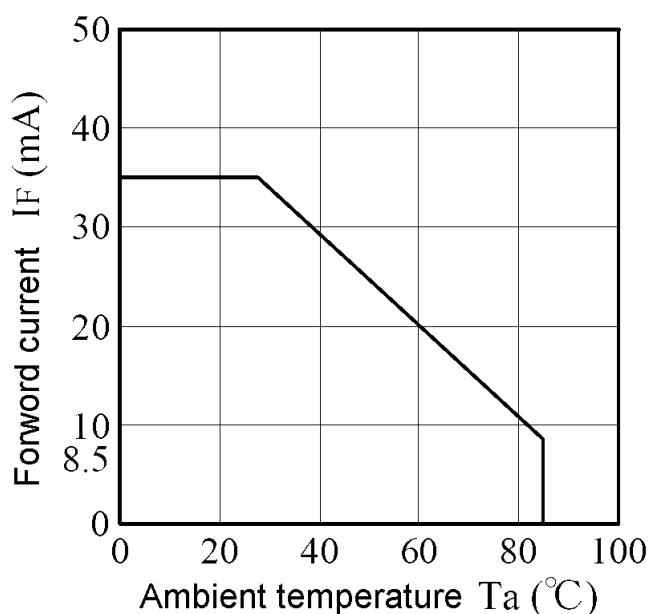

6. Electrical Characteristics

6-1. TFT LCD Panel Driving

Ta = 25°C

Item		Symbol	Min.	Typ.	Max.	Unit	Remarks
Logic I/O power supply	DC voltage	IOVCC	+3.0	+3.3	+3.6	V	
	DC current	I _{IOVCC}	-	0.1	0.2	mA	Note 6-1
Analog power supply	DC voltage	VCC	+3.2	+3.3	+3.4	V	Note 6-1 Note 6-6
	DC current	I _{VCC}	-	16	24	mA	Note 6-3
Permissive input Ripple voltage		V _{RFIOVCC}	-	-	100	mVp-p	Note 6-4
		V _{RFVCC}	-	-	100	mVp-p	Note 6-4
Logic Input Voltage	High	V _{IH}	0.8xIOVCC	-	IOVCC	V	Note 6-5
	Low	V _{IL}	0	-	0.2xIOVCC	V	Note 6-5
Logic input Current		I _{IH} / I _{IL}	-1	-	1	μA	Note 6-5

[Note 6-1] IOVCC = +3.3V, VCC = +3.3V, f_{VSYNC} = 60Hz

Current situation for I_{IOVCC}: Black & White checker flag pattern

[Note 6-2] Refer to Recommended Capacitors and Register setting.

[Note 6-3] IOVCC = +3.3V, VCC = +3.3V, f_{VSYNC} = 60Hz

Current situation for I_{VCC}: All black pattern

[Note 6-4] IOVCC = +3.3V, VCC = +3.3V

[Note 6-5] RESB, SHUT, CSB, SDI, SCK, DEN, B5~B0, G5~G0, R5~R0, VSYNC, HSYNC, DOTCLK

[Note 6-6] When it is out of the above recommended operating voltage, for example, in case of
 $+3.0V \leq VCC < +3.3V$, $+3.4V < VCC \leq +3.6V$, the module does not break.

But the deterioration of display quality, flicker etc., may be occurred.

6-2. Register Setting

IOVCC and VCC ON (※hold RESB = "L", hold SHUT = "H")

↓
Wait min. 1ms↓
Hard Reset (RESB "L" → "H")↓
Wait max.100us↓
Display Data Start (DOTCLK, HSYNC, VSYNC)↓
Register Setting (※)

Reg. #	Register	Data (Gamma2.2)	Remark
R00 h	Panel Driving Control	0013 h	Note 6-7
R01 h	Power Control 1	9A09 h	
R02 h	Power Control 2	9A11 h	
R03 h	Power Control 3	1100 h	
R04 h	Power Control 4	1100 h	
R05 h	Power Control 5	0232 h	
R06 h	Horizontal Back Porch Control	000E h	Note 6-8
R07 h	Vertical Back Porch Control	0004 h	Note 6-9
R09 h	Interface Control	0001 h	
R0A h	Power Control 6	1A61 h	
R0B h	Power Control 7	FF9B h	
R0C h	Power Control 8	00B0 h	
R0D h	Power Control 9	CA53 h	
R0E h	Power Control 10	CA53 h	
R10 h	Gamma Set 1	0616 h	
R11 h	Gamma Set 2	7916 h	
R12 h	Gamma Set 3	0805 h	
R13 h	Gamma Set 4	0217 h	
R14 h	Gamma Set 5	3121 h	
R15 h	Gamma Set 6	1707 h	
R16 h	Gamma Set 7	750F h	
R17 h	Gamma Set 8	1B0D h	
R18 h	Gamma Set 9	0106 h	
R19 h	Gamma Set 10	1112 h	

↓
Wait min. 5ms↓
Sleep mode → Normal mode conversion (SHUT "H" → "L")↓
Wait min.10 frame↓
Back light ON↓
Display ON

※If a setting other than the Register setting is captured temporarily due to disturbances such as electrostatic discharge, the normal display is restored by transmitting the recommended setting again.

(At this time, it is not necessary to turn on the power again or perform initializing with RESB.)

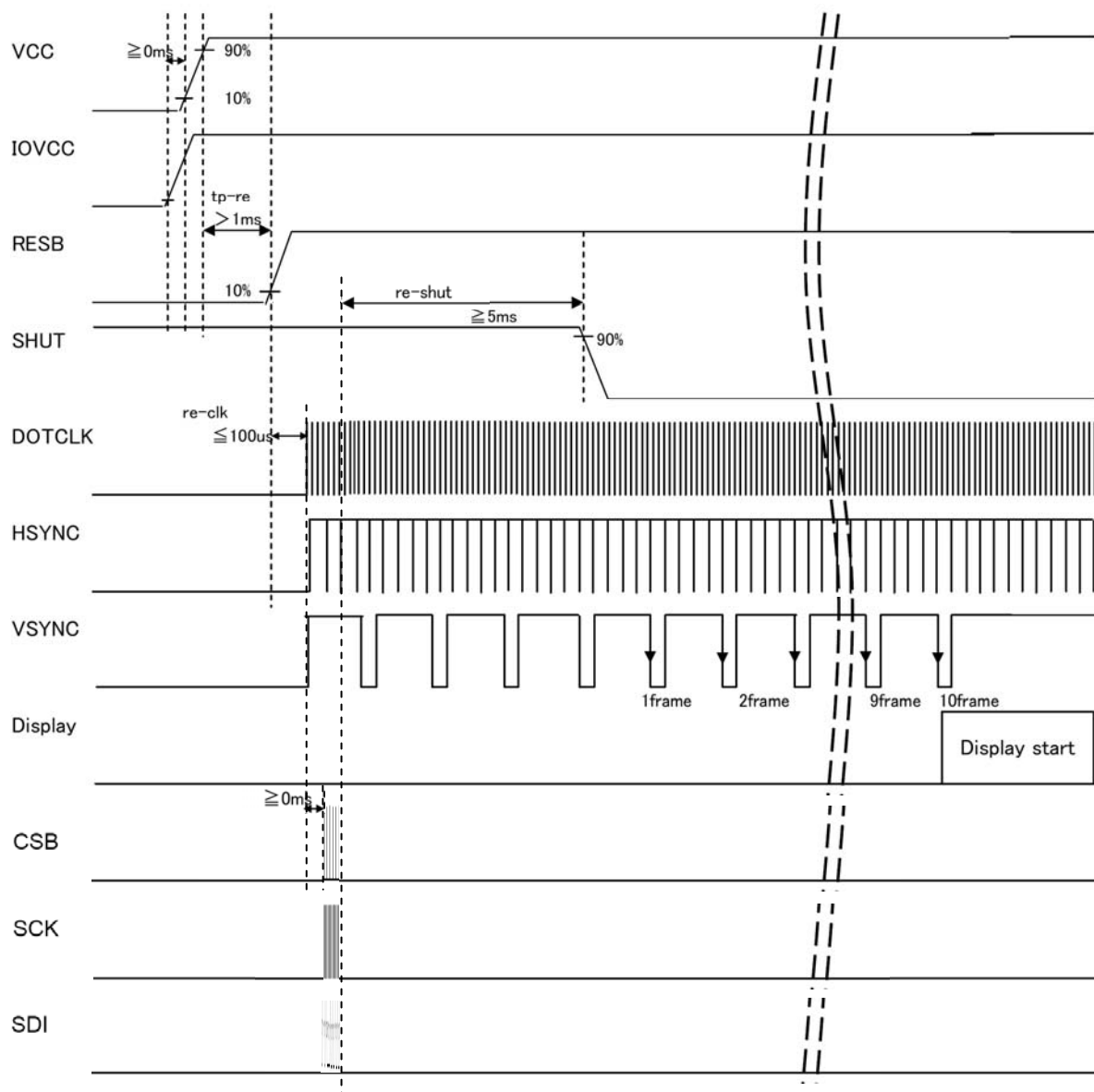

Characteristics	symbol	Min	Typ	Max	Units
VCC on to rising edge of RESB	tp-re	1	-	-	ms
Register set to Falling edge of SHUT	re-shut	5	-	-	ms
RESB on to rising edge of DOTCLK	re-clk	-	-	100	usec
Falling edge of SHUT to display start	tshut-on	-	-	10	frame
-- 1 line: 512 clk		-	167	-	msec
-- 1 frame: 278 line		-	167	-	msec
-- PIXCLK = 8.5MHz					

※Display starts at 10th falling edge of VSYNC after the falling edge of SHUT.

[Note 6-7]

Panel Driving Control (R00h)

R/W	DC	IB15	IB14	IB13	IB12	IB11	IB10	IB9	IB8	IB7	IB6	IB5	IB4	IB3	IB2	IB1	IB0
W	1	0	RL	0	0	0	0	TB	0	0	0	0	1	0	0	1	1
POR		0	0	0	0	0	0	0	0	0	0	0	1	0	0	1	1

TB: Selects the output shift direction of the gate driver.

When TB = "0", Top shifts to Bottom.

When TB = "1", Bottom shifts to Top.

RL: Selects the output shift direction of the source driver.

When RL = "0", Left shifts to Right.

When RL = "1", Right shifts to Left.

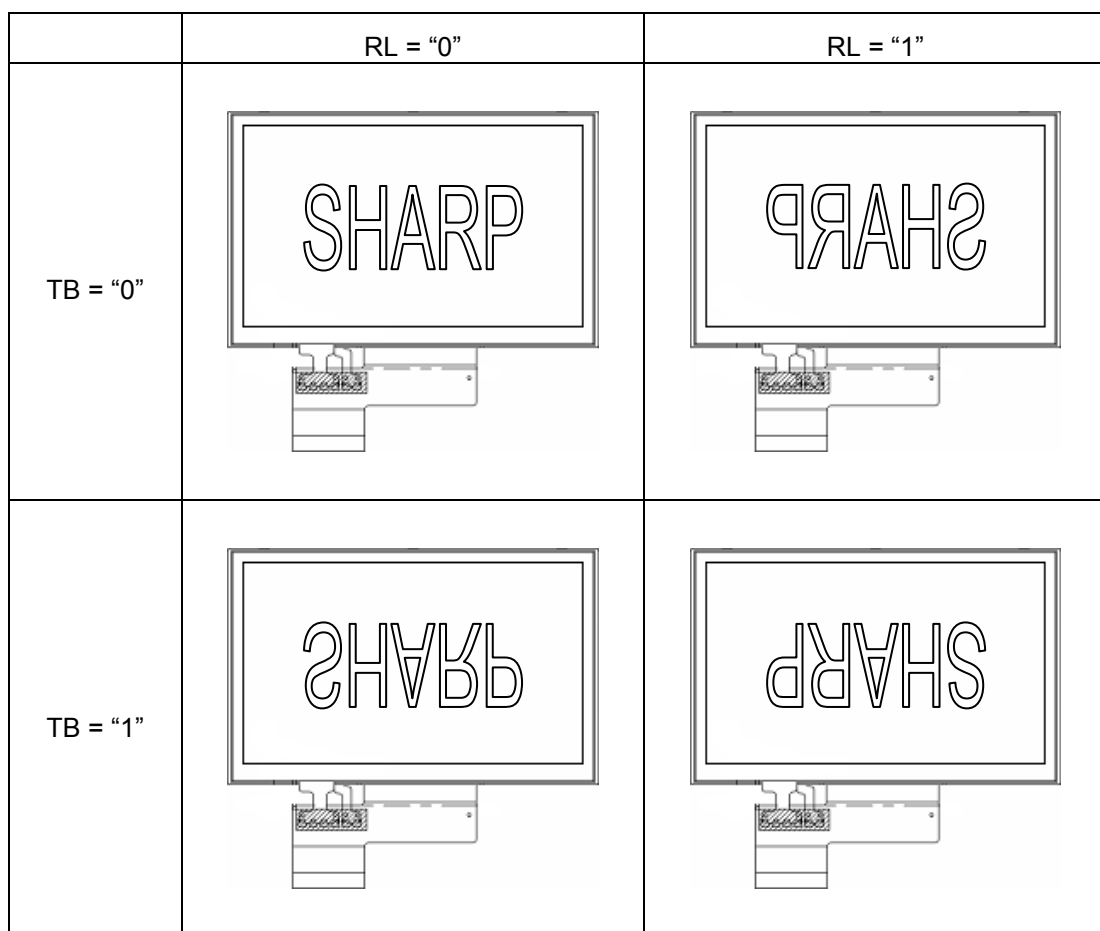

[Note 6-8]

Horizontal Back Porch Control (R06h)

R/W	DC	IB15	IB14	IB13	IB12	IB11	IB10	IB9	IB8	IB7	IB6	IB5	IB4	IB3	IB2	IB1	IB0
W	1	0	0	0	0	0	0	0	0	0	HBP6	HBP5	HBP4	HBP3	HBP2	HBP1	HBP0
POR		0	0	0	0	0	0	0	0	0	0	0	0	1	1	1	0

Number of DOTCLK for HSYNC active low period must be smaller than that of HBP.

HBP6-0: Set the delay period from falling edge of HSYNC signal to first valid data.

HBP6	HBP5	HBP4	HBP3	HBP2	HBP1	HBP0	No. of clock cycle of DOTCLK
0	0	0	0	1	0	0	2
0	0	0	0	1	0	1	3
0	0	0	0	1	1	0	4
0	0	0	0	1	1	1	5
0	0	0	0	0	0	0	6
0	0	0	0	0	0	1	7
0	0	0	0	0	1	0	8
0	0	0	0	0	1	1	9
0	0	0	1	1	0	0	10
⋮							⋮
⋮							Step = 1
⋮							⋮
1	1	1	0	0	1	1	121
1	1	1	1	1	0	0	122
1	1	1	1	1	0	1	123
1	1	1	1	1	1	0	124
1	1	1	1	1	1	1	125
1	1	1	1	0	0	0	126
1	1	1	1	0	0	1	127
1	1	1	1	0	1	0	128
1	1	1	1	0	1	1	129

Example

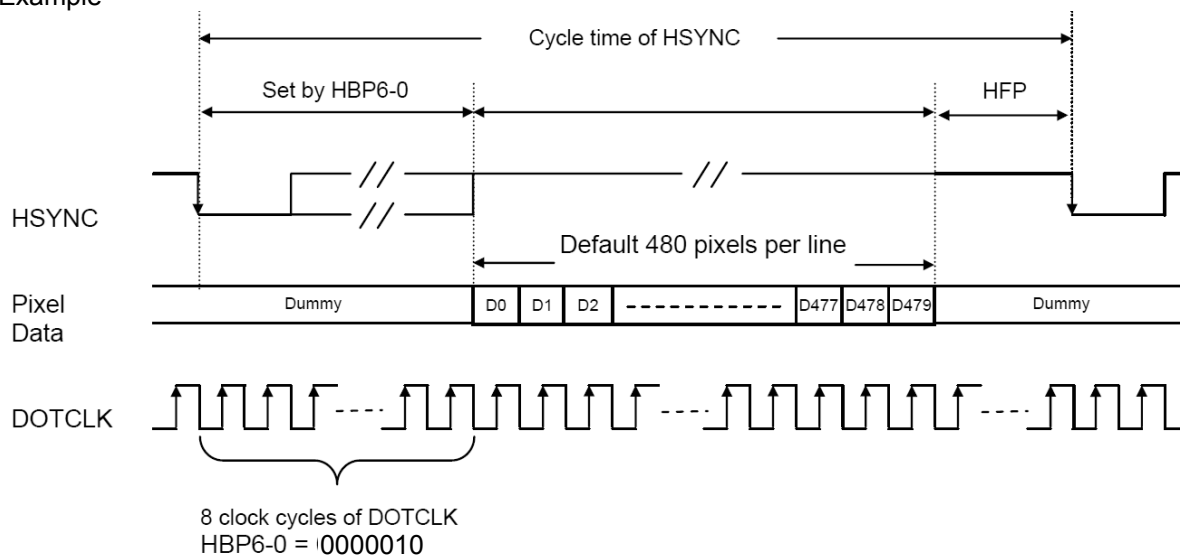

[Note 6-9]

Vertical Back Porch Control (R07h)

R/W	DC	IB15	IB14	IB13	IB12	IB11	IB10	IB9	IB8	IB7	IB6	IB5	IB4	IB3	IB2	IB1	IB0
W	1	0	0	0	0	0	0	0	0	VBP7	VBP6	VBP5	VBP4	VBP3	VBP2	VBP1	VBP0
POR		0	0	0	0	0	0	0	0	0	0	0	0	0	0	1	1

VBP7-0: Set the delay period from falling edge of VSYNC to first valid line.

The line data within this delay period will be treated as dummy line.

VBP7	VBP6	VBP5	VBP4	VBP3	VBP2	VBP1	VBP0	No. of clock cycle of HSYNC
0	0	0	0	0	0	0	0	Setting inhibited
0	0	0	0	0	0	0	1	1
0	0	0	0	0	0	1	0	2
0	0	0	0	0	0	1	1	3
0	0	0	0	0	1	0	0	4
⋮								⋮
⋮								Step = 1
⋮								⋮
1	1	1	0	0	0	0	0	224
1	1	1	0	0	0	0	1	225
1	1	1	1	*	*	*	*	Reserved

Example; VBP = 2 line

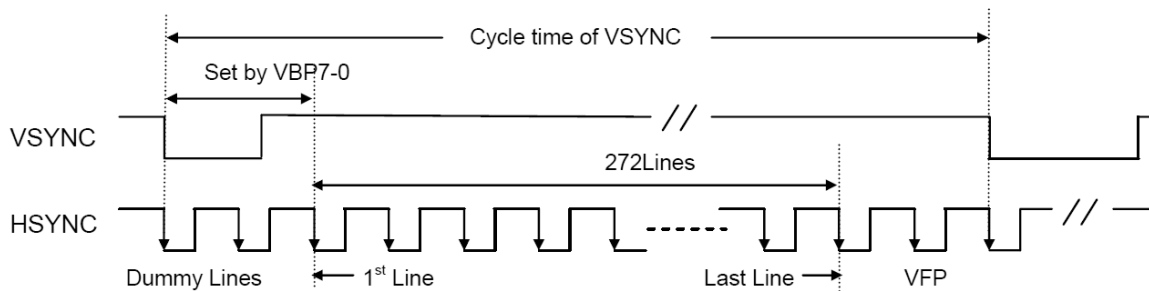

6-3. Power Down Sequence

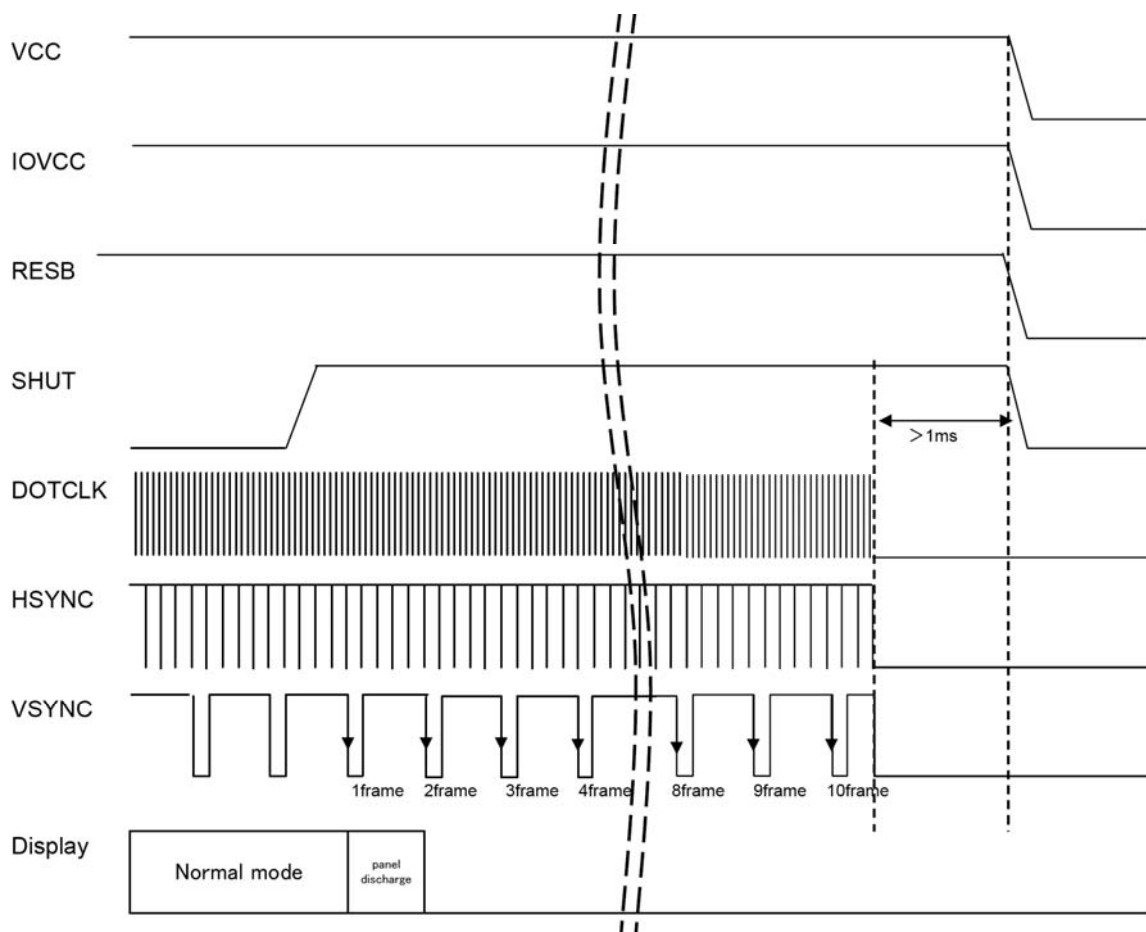
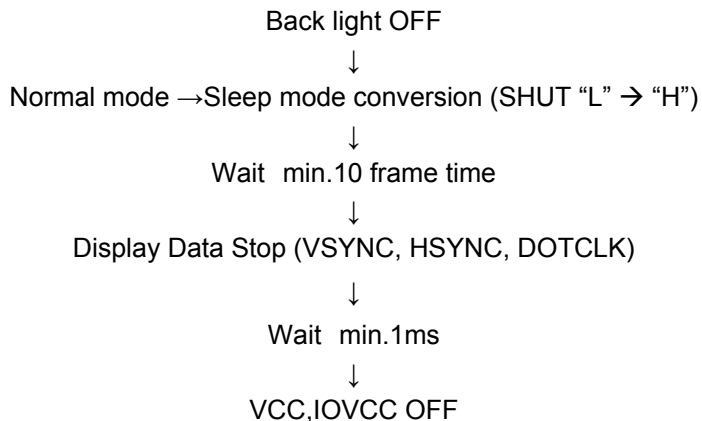

Characteristics	symbol	Min	Typ	Max	Units
Rising edge of SHUT to input-signal off	Tshut-dotclk Off	10	-	-	frame
-- 1 line: 512 clk -- 1 frame: 278 line -- PIXCLK = 8.5MHz		167	-	-	msec
Input-signal-off to IOVCC off	toff-vdd	1	-	-	ms

Note1) DOTCLK/HSYNC/VSYNC must be maintained at least 10 frames after the rising edge of SHUT.

Note2) Display become off at the 2nd falling edge of VSYNC after the rising edge of SHUT.

6-4. Back light driving

The back light system has 9 pieces LED

[LED] NSSW006T (Nichia)

Parameter	Symbol	Min.	Typ.	Max.	Unit	Remark
Rated Voltage	V_{BL}	-	28.8	31.5	V	
Rated Current	I_L	-	20	-	mA	Ta=25°C
Power consumption	W_L	-	576	-	mW	

[LED-FPC circuit]

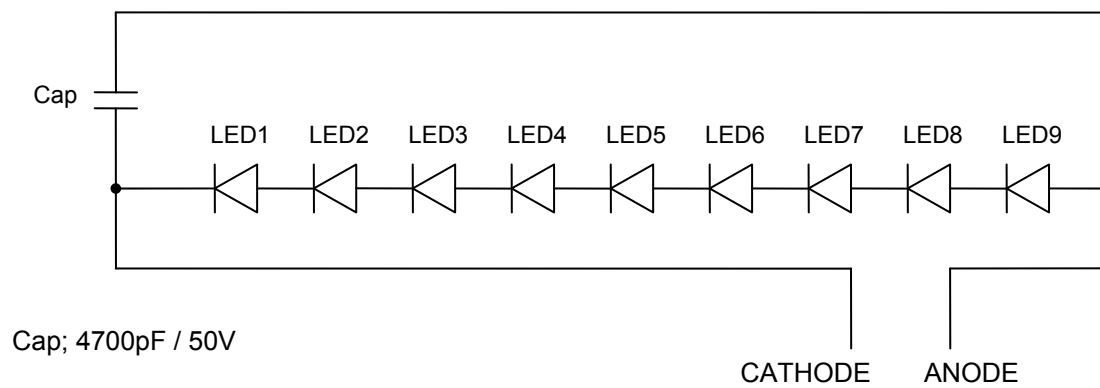

7. Timing characteristics of input signals

7-1. Pixel Clock Timing

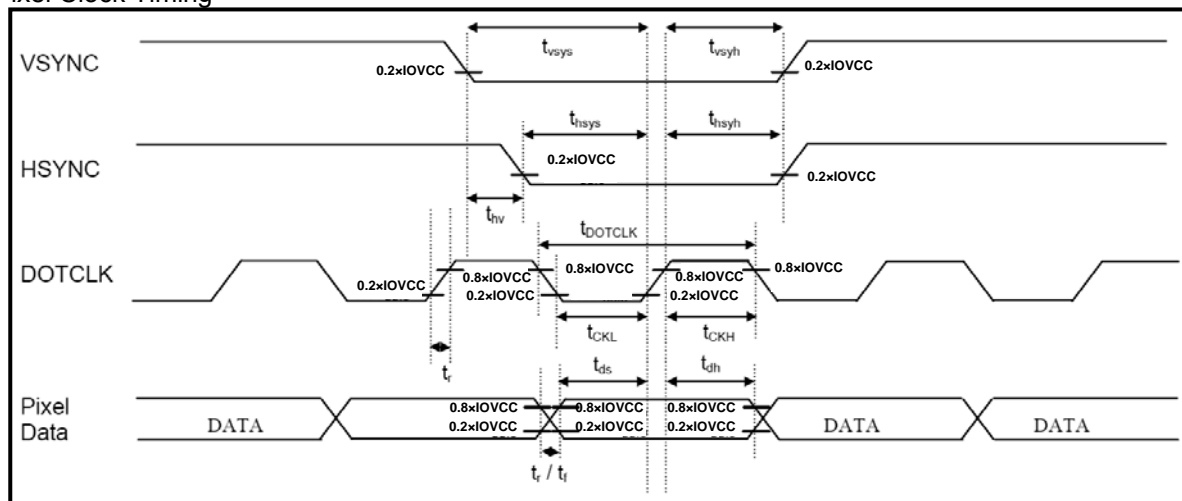

IOVCC=2.7V~3.6V

Characteristics	Symbol	Min	Typ	Max	Units
DOTCLK Frequency	f_{DOTCLK}	-	8.54	12	MHz
DOTCLK Period	t_{DOTCLK}	83	-	-	nsec
DOTCLK Low Period	t_{CKL}	41	-	-	nsec
DOTCLK High Period	t_{CKH}	41	-	-	nsec
Vertical Sync Setup Time	t_{vsys}	20	-	-	nsec
Vertical Sync Hold Time	t_{vsyh}	20	-	-	nsec
Horizontal Sync Setup Time	t_{hsys}	20	-	-	nsec
Horizontal Sync Hold Time	t_{hsyh}	20	-	-	nsec
Phase difference of Sync signal falling edge	t_{hv}	0	-	$t_{\text{H}} - 2$	t_{DOTCLK}
Data Setup Time	t_{ds}	20	-	-	nsec
Data Hold Time	t_{dh}	20	-	-	nsec
Rise / Fall Time	t_r / t_f	-	-	10	nsec

7-2. 18-bit RGB Interface Timing Diagram & Transaction Example

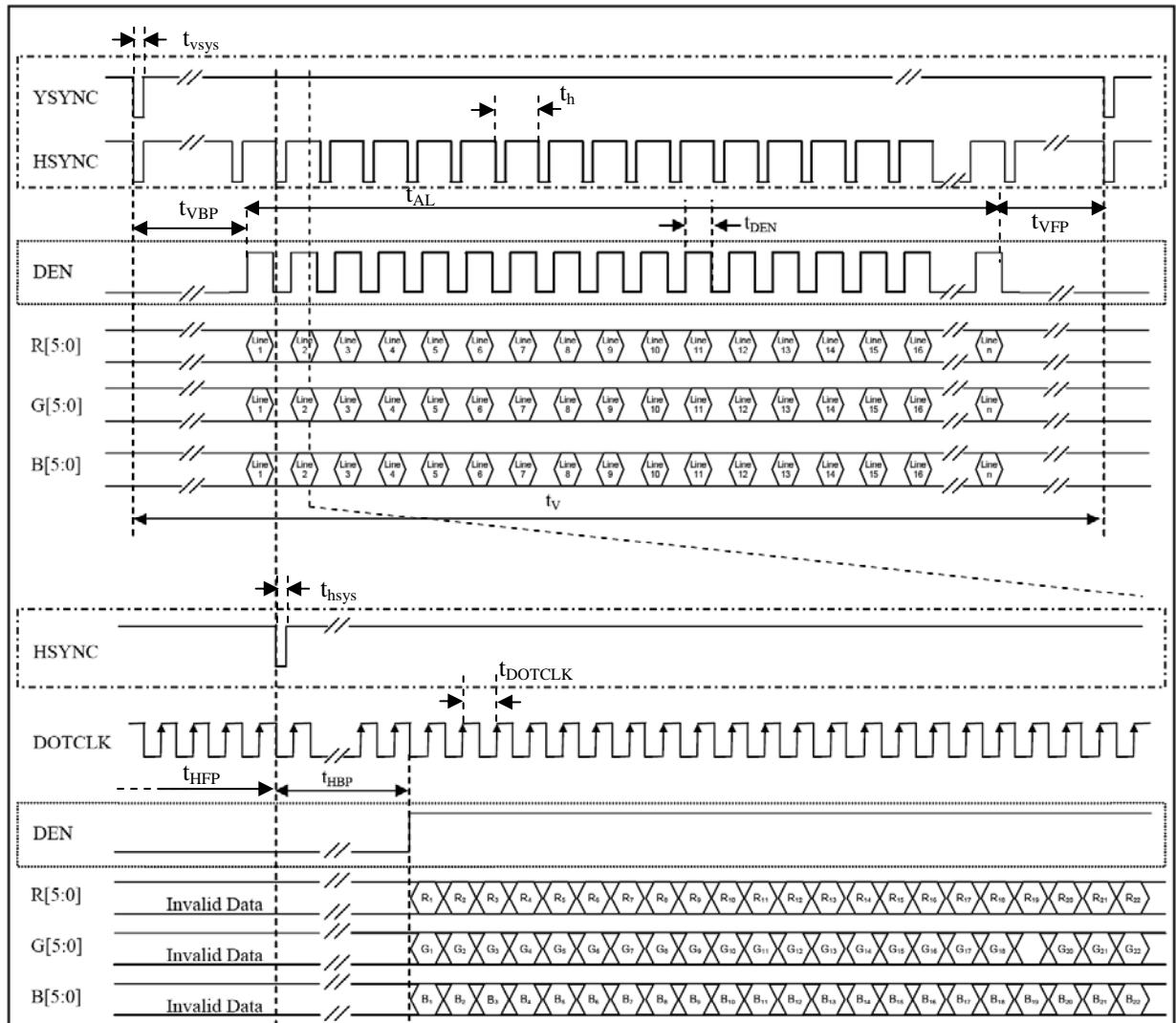

Characteristics		Symbol	DEN Mode ※			Units
			Min	Typ	Max	
Serial Clock Frequency		$1/t_{DOTCLK}$	—	8.54	12.0	MHz
Horizontal	One Line Period	t_H	505	512	—	t_{DOTCLK}
	Active Data Period	t_{data}, t_{DEN}	480	480	480	t_{DOTCLK}
	Horizontal Back Porch	t_{HBP}	2	16	—	t_{DOTCLK}
	Horizontal Front Porch	t_{HFP}	2	16	—	t_{DOTCLK}
	Horizontal sync Period	t_{hsys}	2	—	$t_H - 2$	t_{DOTCLK}
Vertical	One Field Period	t_V	275	278	—	t_H
	Active Line Period	t_{AL}	272	272	272	t_H
	Vertical Back Porch	t_{VBP}	2	4	—	t_H
	Vertical Front Porch	t_{VFP}	1	2	—	t_H
	Vertical sync Period	t_{vsys}	1	2	$T_V - 2$	t_H
	Frequency※	$1/t_v$	50	60	-	t_H

※If frequency is low, the display grade, flicker and others may become deterioration. Keep frequency over 50Hz($1/T_v$). Although this module is operated in DEN mode to decide a horizontal first position, the inputs of not only DEN but Hsync and Vsync are also required.

7-3. SPI Interface Timing Diagram & Transaction Example (3-wires 24 bit)

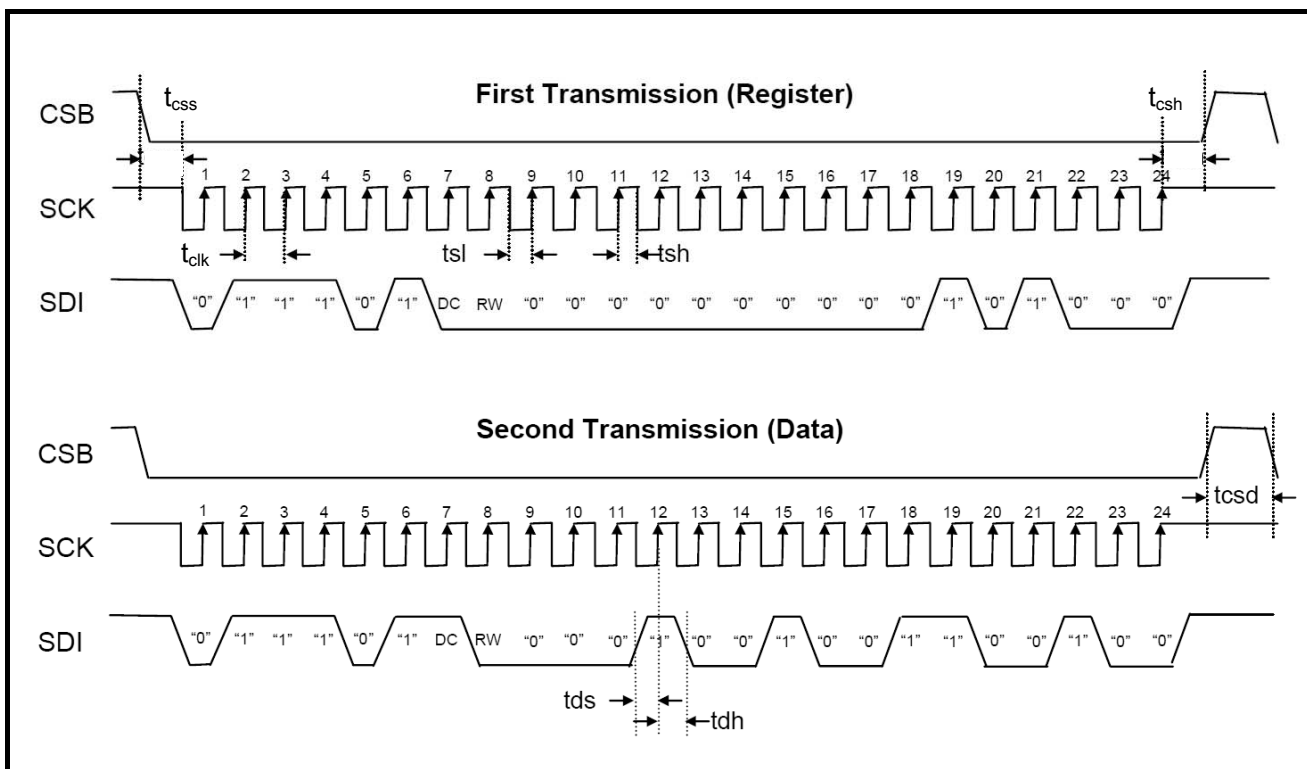

IOVCC=2.7V~3.6V

Characteristics	symbol	Min	Typ	Max	Units
Serial Clock Frequency	fclk	-	-	20	MHz
Serial Clock Cycle Time	tclk	50	-	-	nsec
Clock Low Width	tsl	25	-	-	nsec
Clock High Width	tsh	25	-	-	nsec
Chip Select Setup Time	tc _{ss}	10	-	-	nsec
Chip Select Hold Time	tc _{sh}	10	-	-	nsec
Chip Select High Delay Time	tc _{sd}	25	-	-	nsec
Data Setup Time	tds	10	-	-	nsec
Data Hold Time	tdh	10	-	-	nsec

Register write example example) write 「1264h」 to Register # 「R28h」

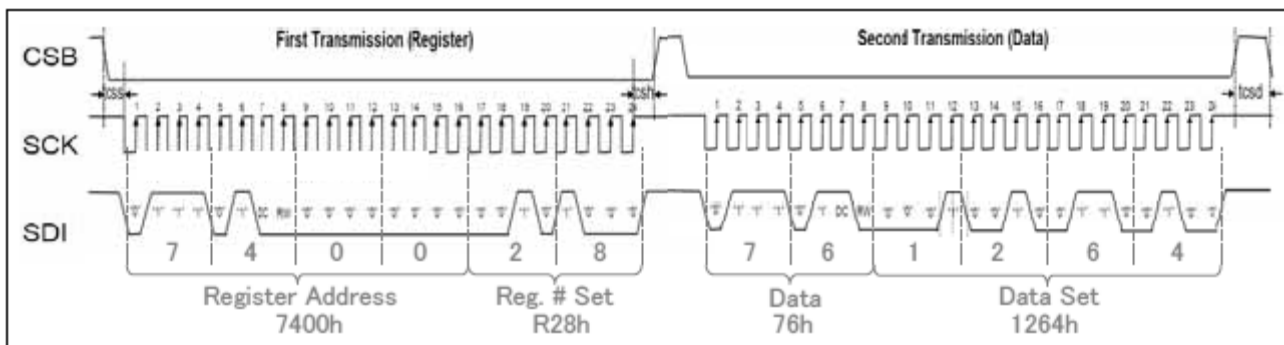

7-4. Input Data Signals and Display Position on the screen

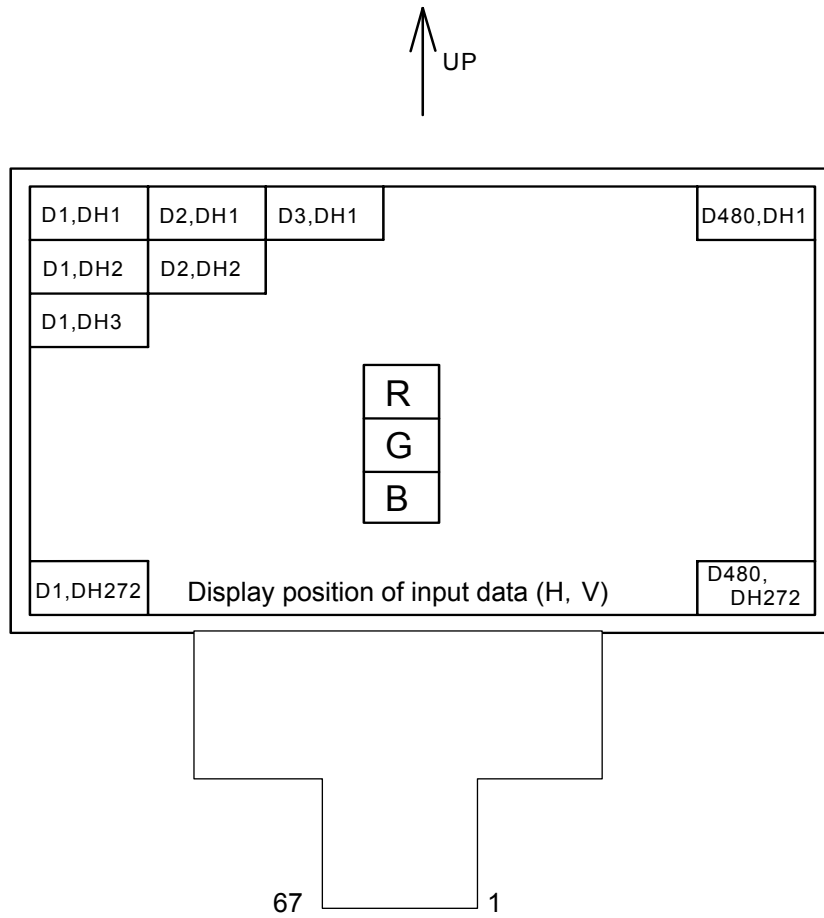

8. Input Signals, Basic Colors and Gray Scale of Each Color

	Colors &	Date signal																					
		Gray Scale	Gray	R0	R1	R2	R3	R4	R5	G0	G1	G2	G3	G4	G5	B0	B1	B2	B3	B4	B5		
			Scale	LSB					MSB					LSB					MSB				
Basic Color	Black	—	0	0	0	0	0	0	0	0	0	0	0	0	0	0	0	0	0	0			
	Blue	—	0	0	0	0	0	0	0	0	0	0	0	0	1	1	1	1	1	1			
	Green	—	0	0	0	0	0	0	1	1	1	1	1	1	0	0	0	0	0	0			
	Cyan	—	0	0	0	0	0	0	1	1	1	1	1	1	1	1	1	1	1	1			
	Red	—	1	1	1	1	1	1	0	0	0	0	0	0	0	0	0	0	0	0			
	Magenta	—	1	1	1	1	1	1	0	0	0	0	0	0	1	1	1	1	1	1			
	Yellow	—	1	1	1	1	1	1	1	1	1	1	1	1	0	0	0	0	0	0			
	White	—	1	1	1	1	1	1	1	1	1	1	1	1	1	1	1	1	1	1			
Gray Scale of Red	Black	GS0	0	0	0	0	0	0	0	0	0	0	0	0	0	0	0	0	0	0			
	↑	GS1	1	0	0	0	0	0	0	0	0	0	0	0	0	0	0	0	0	0			
	Darker	GS2	0	1	0	0	0	0	0	0	0	0	0	0	0	0	0	0	0	0			
	↑	↓	↓					↓					↓										
	↓	↓	↓					↓					↓										
	Brighter	GS61	1	0	1	1	1	1	0	0	0	0	0	0	0	0	0	0	0	0			
	↓	GS62	0	1	1	1	1	1	0	0	0	0	0	0	0	0	0	0	0	0			
	Red	GS63	1	1	1	1	1	1	0	0	0	0	0	0	0	0	0	0	0	0			
Gray Scale of Green	Black	GS0	0	0	0	0	0	0	0	0	0	0	0	0	0	0	0	0	0	0			
	↑	GS1	0	0	0	0	0	0	1	0	0	0	0	0	0	0	0	0	0	0			
	Darker	GS2	0	0	0	0	0	0	0	1	0	0	0	0	0	0	0	0	0	0			
	↑	↓	↓					↓					↓										
	↓	↓	↓					↓					↓										
	Brighter	GS61	0	0	0	0	0	0	1	0	1	1	1	1	0	0	0	0	0	0			
	↓	GS62	0	0	0	0	0	0	0	1	1	1	1	1	0	0	0	0	0	0			
	Green	GS63	0	0	0	0	0	0	1	1	1	1	1	1	0	0	0	0	0	0			
Gray Scale of Blue	Black	GS0	0	0	0	0	0	0	0	0	0	0	0	0	0	0	0	0	0	0			
	↑	GS1	0	0	0	0	0	0	0	0	0	0	0	0	1	0	0	0	0	0			
	Darker	GS2	0	0	0	0	0	0	0	0	0	0	0	0	0	1	0	0	0	0			
	↑	↓	↓					↓					↓										
	↓	↓	↓					↓					↓										
	Brighter	GS61	0	0	0	0	0	0	0	0	0	0	0	0	1	0	1	1	1	1			
	↓	GS62	0	0	0	0	0	0	0	0	0	0	0	0	0	1	1	1	1	1			
	Blue	GS63	0	0	0	0	0	0	0	0	0	0	0	0	1	1	1	1	1	1			

0: Low level voltage, 1: High level voltage

Each basic color can be displayed in 64 gray scales from 6 bit data signals.

According to the combination of 18 bit data signals, the 262k color display can be achieved on the screen.

9. Optical Characteristics

Module characteristics

Ta = 25°C, IOVCC = +3.3V, VCC = +3.3V

Parameter		Symbol	Condition	Min.	Typ.	Max.	Unit	Remark
Viewing angle range (With Wide View)	Horizontal	$\theta 3$	$CR \geq 10$	-	80	-	deg.	[Note 9-1] [Note 9-4]
		$\theta 9$		-	80	-	deg.	
	Vertical	$\theta 12$		-	55	-	deg.	
		$\theta 6$		-	80	-	deg.	
Contrast ratio		CR	Optimum viewing angle	250	500	-	-	[Note 9-2] [Note 9-4]
Response Time	Rise	Tr	$\theta=0^\circ$	-	22	40	ms	[Note 9-3]
	Decay	Td		-	8	20	ms	[Note 9-4]
Chromaticity of White		x		0.26	0.31	0.36	-	[Note 9-4]
		y		0.29	0.34	0.39	-	
Luminance of white		XL		240	360	-	cd/m ²	I _{LED} =20mA [Note 9-4]
The life of LED (Reference)			I _{LED} =20mA	(10,000)			hour	[Note 9-5]

* The optical characteristics measurements are operated under a stable luminescence (I_{LED} = 20mA) and a dark condition. (Refer to Fig.9-1 and Fig.9-2)

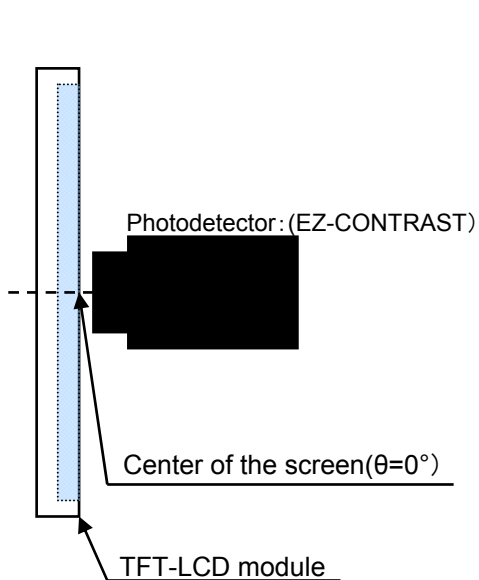

Fig.9-1 Viewing angle range measurement method

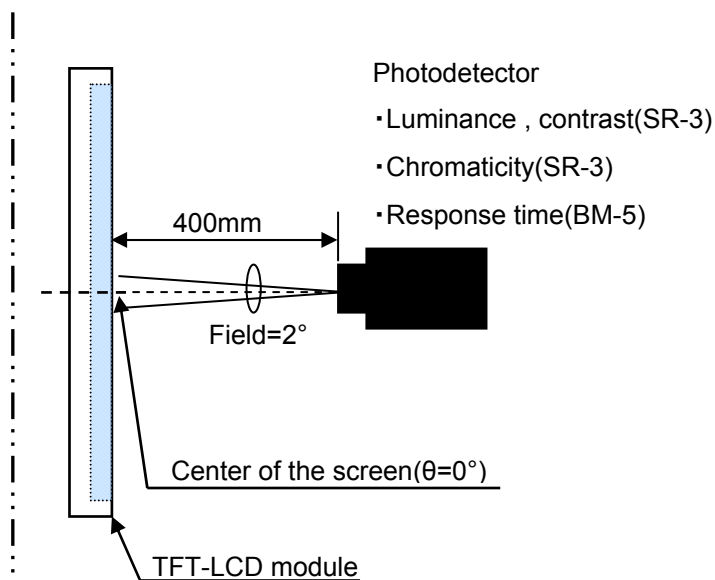
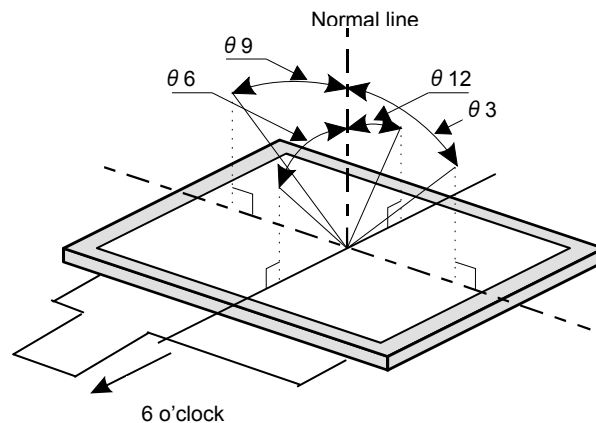

Fig.9-2 Luminance / Contrast/Chromaticity / Response time measurement method

[Note 9-1] Definitions of viewing angle range



[Note 9-2] Definition of contrast ratio

The contrast ratio is defined as the following

$$\text{Contrast ratio (CR)} = \frac{\text{Luminance (brightness) with all pixels white}}{\text{Luminance (brightness) with all pixels black}}$$

[Note 9-3] Definition of response time

The response time is defined as the following figure and shall be measured by switching the input signal for "black" and "white"

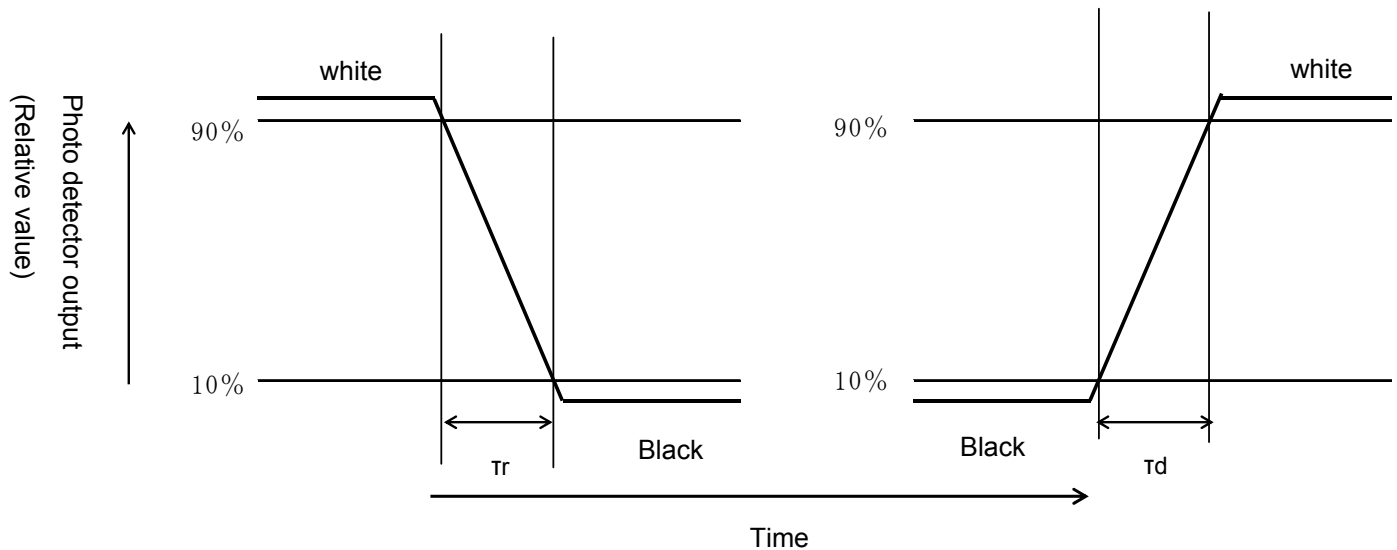

[Note 9-4] This shall be measured at center of the screen.

[Note 9-5] The life of LED (Reference)

Luminosity will become 50% or more for an initial value in about 10,000H which condition is $T_a=25^\circ\text{C}$ and $I_{LED}=20\text{mA}$.

10. Handling of modules

10-1. Inserting the FPC into its connector and pulling it out.

- 1) Be sure to turn off the power supply and the signals when inserting or disconnecting the cable.
- 2) Please insert for too much stress not to join FPC in the case of insertion of FPC.

10-2. Handling of FPC

- 1) The bending radius of the FPC on flexible part should be more than R0.6mm, and it should be bent evenly.
- 2) Do not dangle the LCD module by holding the FPC, or do not give any stress to it.
- 3) Do not add stress to the terminal area of FPC and LCD panel.
- 4) Do not bend FPC to the display direction when handling and mounting.

10-3. Mounting of the module

- 1) The module should be held on to the plain surface. Do not give any warping or twisting stress to the module.
Refer to 18.Outline Dimensions about the handling area in surface and gasket area in back. When LCD surface is pushed by the power over $300\text{gf}/\text{cm}^2$, with use of handling area, the pooling may occur at a different place from the pushed place. Because there is a grade difference in the pooling, check and judge after mounting.
- 2) Please consider that GND can ground a modular metal portion etc. so that static electricity is not charged to the module.

10-4. Cautions in assembly / Handling pre cautions.

As the polarizer can be easily scratched, be most careful in handling it. The protect film is attached on the module surface. Remove the film carefully to static electricity as much as possible just before use.

1) Notes about removing the protect film on the module surface

A) Work environments

Since removing laminator may causes electrostatic charge that tends to attract dust, the following work environment would be desired.

- a) Implement more than $1\text{M}\Omega$ conductive treatment (by placing a conductive mat or applying conductive paint on the floor or tiles.)
- b) No dusts come in to the working room. Place an adhesive, anti-dust mat at the entrance of the room.
- c) Humidity of 50 to 70% and temperature of 15 to 27°C are desirable.
- d) All workers wear conductive shoes, conductive clothes, conductive fingerstalls and grounding belts without fail.

B) Instruction for working

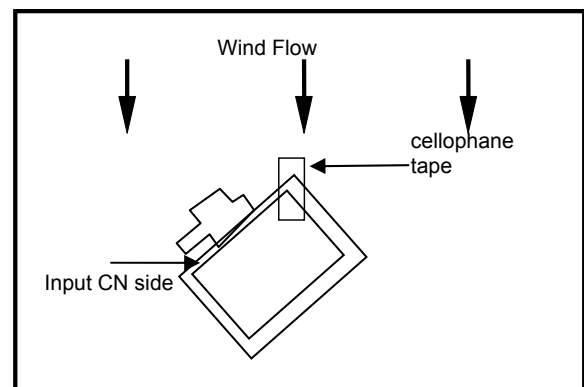
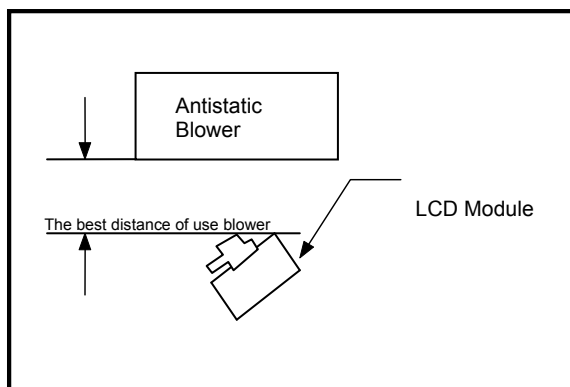

a) Wind direction of an antistatic blower should slightly downward to properly blow the module.

The distance between the blower and the module should be the best distance of use blower.

Also, pay attention to the direction of the module. [See the above]

b) To prevent the polarizer from scratching, adhesive tape (cellophane tape) should be stuck at the part of laminator sheet, which is closed to blower. [See the above]

c) Pull slowly adhesive tape to peel the laminator off, with spending more than 5 second.

d) The module without laminator should be moved to the next process to prevent adhesion of dust.

2) How the remove dust on the polarizer

a) Blow out dust by the use of an N2 blower with antistatic measures taken. Use of an ionized air Gun is recommendable.

b) When the panel surface is soiled, wipe it with soft cloth.

3) In the case of the module's metal part (shield case) is stained, wipe it with a piece of dry, soft cloth. If rather difficult, give a breath on the metal part to clean better.

4) If water dropped, etc. remains stuck on the polarizer for a long time, it is apt to get discolored or cause stains. Wipe it immediately.

5) As a glass substrate is used for the TFT-LCD panel, if it is dropped on the floor or hit by something hard, it may be broken or chipped off. Take care of handling.

6) Since CMOS LSI is used in this module, take care of static electricity and take the human earth into consideration when handling.

10-5. Others

1) Regarding storage of LCD modules, avoid storing them at direct sunlight-situation.

You are requested to store under the following conditions:

(Environmental conditions of temperature/humidity for storage)

a) Temperature: 0 to 40°C

b) Relative humidity : 95% or less

As average values of environments (temperature and humidity) for storing, use the following control guidelines:

Summer season: 20 to 35°C, 85% or less Winter season: 5 to 15°C, 85% or less.

If stored under the conditions of 40°C and 95% RH, cumulative time of storage must be less than 240 hours.

2) If stored at temperatures below the rated values, the inner liquid crystal may freeze, causing cell destruction. At temperatures exceeding the rated values for storage, the liquid crystal may become isotropic liquid, making it no longer possible to come back to its original state in some cases. Please store as near room temperature as possible.

3) If the LCD is broken, do not drink liquid crystal in the mouth. If the liquid crystal adheres to a hand or foot or to clothes, immediately cleanse it with soap.

4) If a water drop or dust adheres for a long time, it is apt to cause deterioration. Wipe it immediately.

5) Be sure to observe other caution items for ordinary electronic parts and components.

6) If local pressure joins T/P surface for a long time, it will become the cause of generating of Newton's ring.

7) When handling and assembling this LCD module, avoid using and storing this module for a long time at the place where Oxidization gas and Reduction gas (SO₂, H₂S etc) including the reagent, the adhesives and

resin etc which generate these gases may exist in the atmosphere because of corrosion, discoloration, an abnormal display and operation of this module. An abnormal display by changing in quality of the polarizer might occur regardless of contact or no contact to the polarizing plate, because of epoxy resin (amine system curing agent) that comes out from the material and the packaging material used for the set side, the silicon adhesive (dealcoholization system and oxime system), and the tray blowing agents (azo-compound), etc. Please confirm adaptability with your employed material.

11 Reliability test items

No.	Test item	Conditions
1	High temperature storage test	Ta = 85°C, 240h
2	Low temperature storage test	Ta = -30°C, 240h
3	High temperature & high humidity operation test	Ta = 60°C , 90%RH, 240h (No condensation)
4	High temperature operation test	Tp = 70°C, 240h
5	Low temperature operation test	Ta = -10°C, 240h
6	Vibration test (non-operating)	Frequency range: 10 to 55Hz, Stroke: 1.5mm Sweep time: 1min, Test period: 2hours for each direction of X, Y, Z
7	Shock test	Direction: ±X, ±Y, ±Z, Time: Third for each direction. Impact value: 980m/s ² , Action time 6ms
8	Thermal shock test	Ta = -10°C to 70°C, 10 cycles (0.5h) (0.5h)

[Note 11-1] Ta = Ambient temperature, Tp = Panel temperature

[Check items]

Test No.1 to No.8

In the standard condition, there shall be no practical problems that may affect the display function.

12. Display Grade

The standard regarding the grade of color LCD displaying modules should be based on the Incoming Inspection Standards (I.I.S.).

13. Delivery Form

13-1. Carton storage conditions

1) Carton piling-up: Max 8 rows

2) Environments

Temperature: 0~40°C

Humidity: 65% RH or less (at 40°C)

There should be no dew condensation even at a low temperature and high humidity.

Period : Approximately 3month

3) Packing form: As shown in Figure.

*Cartons are weak against damp, and they are apt to be smashed easily due to the compressive pressure applied when piled up. The above environmental conditions of temperature and humidity are set in consideration of reasonable pile-up for storage.

13-2. Packing composition

Name	quantity	Note
Carton size	1	575×360×225 (mm)
Tray	18	Material: Electrification prevention polypropylene
(The number of Module)	128	8 unit/tray: 128 unit/carton
Electrification prevention bag	2	Material: Electrification prevention polyethylene 680mm(length)×500mm(depth)×50μm(thin)

14. Lot No. marking

The lot No. will be indicated on individual inkjet. The location is as shown

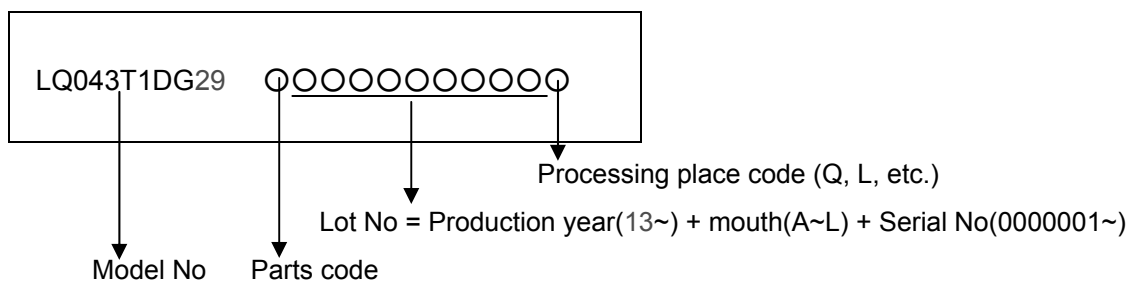

15. LCD module packing carton

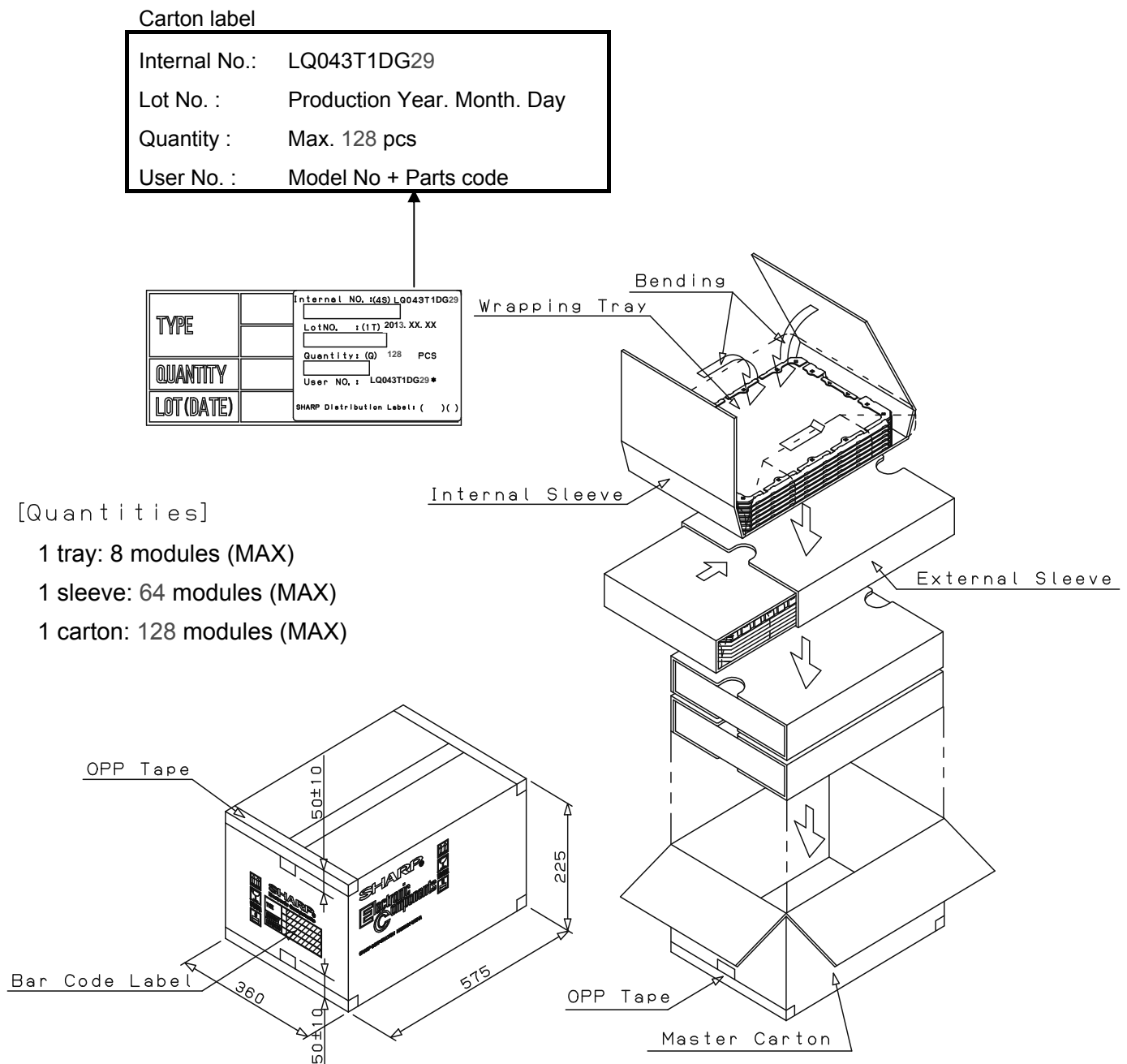

16. Others

- 1) Disassembling the module can cause permanent damage and you should be strictly avoided.
- 2) Please be careful that you don't keep the screen displayed fixed pattern image for a long time, since retention may occur.
- 3) If you pressed down a liquid crystal display screen with your finger and so on, the alignment disorder of liquid crystal will occur. And then It will become display fault.
Therefore, be careful not to touch the screen directly, and to consider not stressing to it.
- 4) If any problem arises regarding the items mentioned in this technical literature or otherwise, it should be discussed and settled mutually in a good faith for remedy and/or improvement.

