

CMOS Linear Applications

National Semiconductor
Application Note 88
July 1973



CMOS Linear Applications

PNP and NPN bipolar transistors have been used for many years in "complementary" type of amplifier circuits. Now, with the arrival of CMOS technology, complementary P-channel/N-channel MOS transistors are available in monolithic form. The MM74C04 incorporates a P-channel MOS transistor and an N-channel MOS transistor connected in complementary fashion to function as an inverter.

Due to the symmetry of the P- and N-channel transistors, negative feedback around the complementary pair will cause the pair to self bias itself to approximately 1/2 of the supply voltage. Figure 1 shows an idealized voltage transfer characteristic curve of the CMOS inverter connected with negative feedback. Under these conditions the inverter is biased for operation about the midpoint in the linear segment on the steep transition of the voltage transfer characteristics as shown in Figure 1.

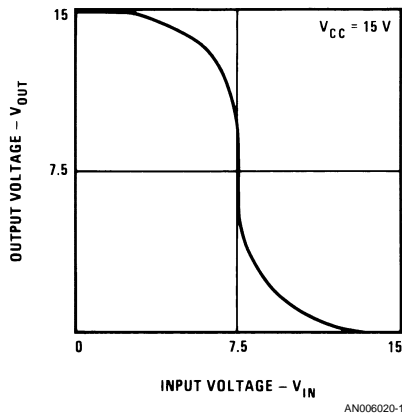

FIGURE 1. Idealized Voltage Transfer Characteristics of an MM74C04 Inverter

Under AC Conditions, a positive going input will cause the output to swing negative and a negative going input will have an inverse effect. Figure 2 shows 1/6 of a MM74C04 inverter package connected as an AC amplifier.

The power supply current is constant during dynamic operation since the inverter is biased for Class A operation. When the input signal swings near the supply, the output signal will become distorted because the P-N channel devices are

driven into the non-linear regions of their transfer characteristics. If the input signal approaches the supply voltages, the P- or N-channel transistors become saturated and supply current is reduced to essentially zero and the device behaves like the classical digital inverter.

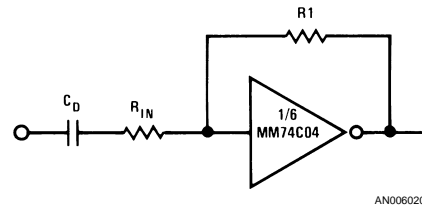

FIGURE 2. A 74CMOS Inverter Biased for Linear Mode Operation

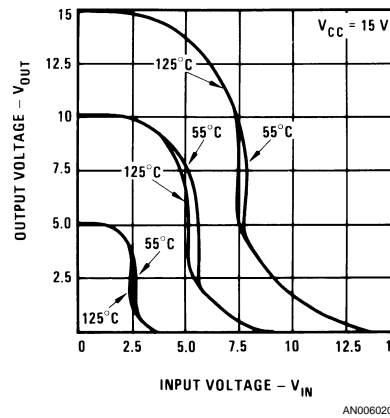
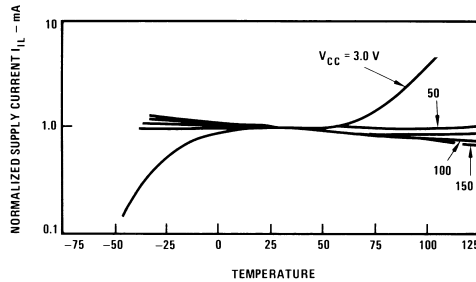

FIGURE 3. Voltage Transfer Characteristics for an Inverter Connected as a Linear Amplifier

Figure 3 shows typical voltage characteristics of each inverter at several values of the V_{CC} . The shape of these transfer curves are relatively constant with temperature. Temperature affects for the self-biased inverter with supply voltage is shown in Figure 4. When the amplifier is operating at 3 volts, the supply current changes drastically as a func-

tion of supply voltage because the MOS transistors are operating in the proximity of their gate-source threshold voltages.



AN006020-4

FIGURE 4. Normalized Amplifier Supply Current Versus Ambient Temperature Characteristics

Figure 5 shows typical curves of voltage gain as a function of operating frequency for various supply voltages.

Output voltages can swing within millivolts of the supplies with either a single or a dual supply.

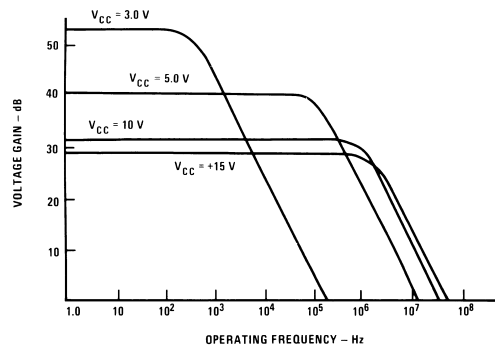

AN006020-5

FIGURE 5. Typical Voltage Gain Versus Frequency Characteristics for Amplifier Shown in Figure 2

APPLICATIONS

Cascading Amplifiers for Higher Gain

By cascading the basic amplifier block shown in Figure 2 a high gain amplifier can be achieved. The gain will be multiplied by the number of stages used. If more than one inverter is used inside the feedback loop (as in Figure 6) a higher open loop gain is achieved which results in more accurate closed loop gains.

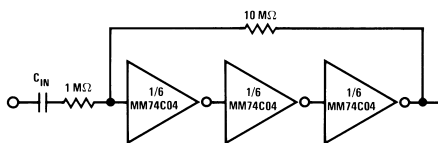

AN006020-6

FIGURE 6. Three CMOS Inverters Used as an X10 AC Amplifier

Post Amplifier for Op Amps

A standard operational amplifier used with a CMOS inverter for a Post Amplifier has several advantages. The operational amplifier essentially sees no load condition since the input impedance to the inverter is very high. Secondly, the CMOS inverters will swing to within millivolts of either supply. This gives the designer the advantage of operating the operational amplifier under no load conditions yet having the full supply swing capability on the output. Shown in Figure 7 is the LM4250 micropower Op Amp used with a 74C04 inverter for increased output capability while maintaining the low power advantage of both devices.

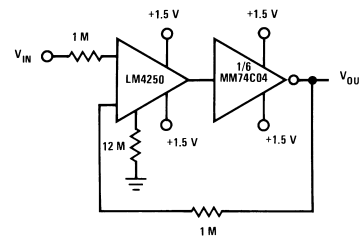

AN006020-7

$P_D = 500 \text{ nW}$

FIGURE 7. MM74C04 Inverter Used as a Post Amplifier for a Battery Operated Op Amp

The MM74C04 can also be used with single supply amplifier such as the LM324. With the circuit shown in Figure 8, the open loop gain is approximately 160 dB. The LM324 has 4 amplifiers in a package and the MM74C04 has 6 amplifiers per package.

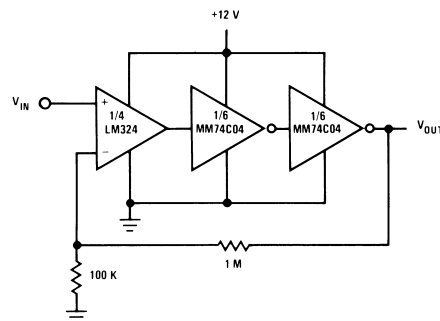

AN006020-8

FIGURE 8. Single Supply Amplifier Using a CMOS Cascade Post Amplifier with the LM324

CMOS inverters can be paralleled for increased power to drive higher current loads. Loads of 5.0 mA per inverter can be expected under AC conditions.

Other 74C devices can be used to provide greater complementary current outputs. The MM74C00 NAND Gate will provide approximately 10 mA from the V_{CC} supply while the MM74C02 will supply approximately 10 mA from the negative supply. Shown in Figure 9 is an operational amplifier using a CMOS power post amplifier to provide greater than 40 mA complementary currents.

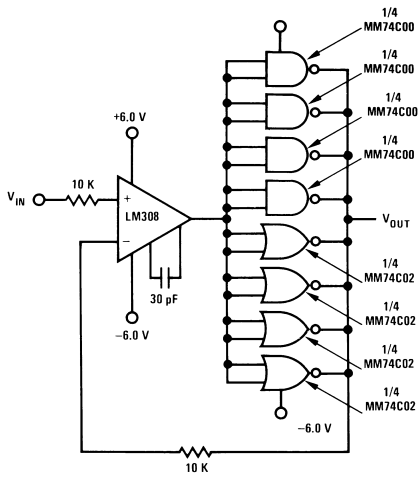

AN006020-9

$I_{OUT} \approx 50 \text{ mA}$
 $V_{OUT} \approx 6.0 \text{ V}_{PP}$

FIGURE 9. MM74C00 and MM74C02 Used as a Post Amplifier to Provide Increased Current Drive

Other Applications

Shown in *Figure 10* is a variety of applications utilizing CMOS devices. Shown is a linear phase shift oscillator and an integrator which use the CMOS devices in the linear mode as well as a few circuit ideas for clocks and one shots.

Conclusion

Careful study of CMOS characteristics show that CMOS devices used in a system design can be used for linear building blocks as well as digital blocks.

Utilization of these new devices will decrease package count and reduce supply requirements. The circuit designer now can do both digital and linear designs with the same type of device.

Phase Shift Oscillator Using MM74C04

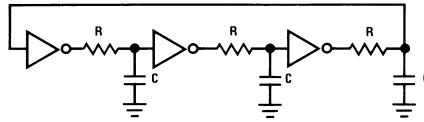

AN006020-10

$$f = \frac{1}{3.3 RC}$$

Integrator Using Any Inverting CMOS Gate

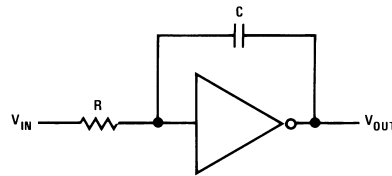

AN006020-11

$$T = RC$$

Square Wave Oscillator

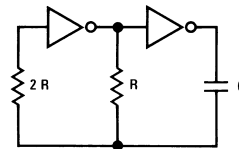

AN006020-12

$$f = \frac{1}{1.4 RC}$$

One Shot

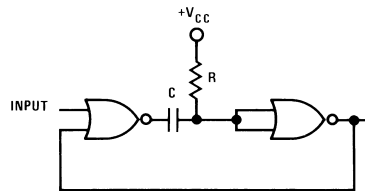

AN006020-13

$$T = 1.4 RC$$

Staircase Generator

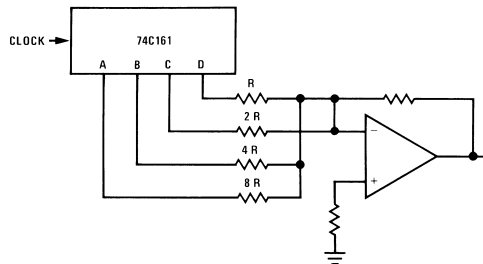

AN006020-14

FIGURE 10. Variety of Circuit Ideas Using CMOS Devices

LIFE SUPPORT POLICY

NATIONAL'S PRODUCTS ARE NOT AUTHORIZED FOR USE AS CRITICAL COMPONENTS IN LIFE SUPPORT DEVICES OR SYSTEMS WITHOUT THE EXPRESS WRITTEN APPROVAL OF THE PRESIDENT OF NATIONAL SEMICONDUCTOR CORPORATION. As used herein:

1. Life support devices or systems are devices or systems which, (a) are intended for surgical implant into the body, or (b) support or sustain life, and whose failure to perform when properly used in accordance with instructions for use provided in the labeling, can be reasonably expected to result in a significant injury to the user.
2. A critical component is any component of a life support device or system whose failure to perform can be reasonably expected to cause the failure of the life support device or system, or to affect its safety or effectiveness.



National Semiconductor Corporation
Americas
Tel: 1-800-272-9959
Fax: 1-800-737-7018
Email: support@nsc.com

National Semiconductor Europe
Fax: +49 (0) 1 80-530 85 86
Email: europe.support@nsc.com
Deutsch Tel: +49 (0) 1 80-530 85 85
English Tel: +49 (0) 1 80-532 78 32
Français Tel: +49 (0) 1 80-532 93 58
Italiano Tel: +49 (0) 1 80-534 16 80

National Semiconductor Asia Pacific Customer Response Group
Tel: 65-2544466
Fax: 65-2504466
Email: sea.support@nsc.com

National Semiconductor Japan Ltd.
Tel: 81-3-5639-7560
Fax: 81-3-5639-7507

www.national.com